



SAKURA

CUMMINS

FILTER SUB-CATALOGUE





Table of Contents

Engine Application

A

Technical Specification

B



Engine Application

A

Sakura Filter

ENGINE APPLICATION

MODEL/APPLICATION	SAKURA NO	MODEL/APPLICATION	SAKURA NO	MODEL/APPLICATION	SAKURA NO
CUMMINS		CUMMINS		CUMMINS	
315 (ENGINES)		C25 D5 P (GENERATORS) CUMMINS X2.5G2		ISB (ENGINES) 3.9L , 3900	
Fuel Filter.....	FC-5721	Oil Filter Full Flow.....	C-57400	Fuel Filter.....	FC-56251
365 (ENGINES)		C25 D6 (GENERATORS) CUMMINS B3.3-G1		ISB4 (ENGINES)	
Fuel Filter.....	FC-5721	Air Filter Primary.....	A-8506	Fuel Filter.....	FC-56251
		Air Filter Set.....	A-8506-S		
76 (MARINE) CUMMINS 4B3.9		C30 D5 P (GENERATORS) CUMMINS 53.8G2		ISBE (ENGINES)	
Fuel Filter Secondary.....	FC-7903	Oil Filter Full Flow.....	C-57400	Fuel Filter.....	FC-56251
Fuel/Water Separator.....	SFC-5706				
Fuel/Water Separator.....	SFC-5708	C33D5 (GENERATORS) CUMMINS 4B3.3			
Oil Filter Full Flow.....	C-5703	Air Filter Primary.....	A-8506		
		Air Filter Set.....	A-8506-S		
C11 D5 (GENERATORS) KUBOTA D1703		C35 D5 P (GENERATORS) CUMMINS 53.8G3		K19 (MARINE) CUMMINS KTA 19-M	
Air Filter Primary.....	A-8506	Oil Filter Full Flow.....	C-57400	Air Filter.....	AH-5710
Air Filter Set.....	A-8506-S				
Fuel Filter.....	F-5210			KTA50-M2 (MARINE) V-16 CYLINDER, 4-STROKE DIESEL , 50000	
		C38 D5 (GENERATORS) CUMMINS 4B3.3G1		Air Filter.....	A-87560
C11 D6 (GENERATORS) KUBOTA D1703		Air Filter Primary.....	A-8506		
Air Filter Primary.....	A-8506	Air Filter Set.....	A-8506-S	(ENGINES) CUMMINS ISB6.7 EURO 5 , TO-2009	
Air Filter Set.....	A-8506-S			Fuel Filter.....	FC-45010
Fuel Filter.....	F-5210	C44 D5 (GENERATORS) CUMMINS 53.8 G4 , 3800		Fuel Filter.....	FC-5725
		Oil Filter By Pass.....	C-57420	Fuel/Water Separator.....	SFC-5711
C15 D5 P (GENERATORS) CUMMINS X1.7G1		C450 D5EB (GENERATORS) CUMMINS QSZ13-G5		Oil Filter Full Flow.....	C-5708
Oil Filter Full Flow.....	C-57400	Air Filter.....	A-44210	Oil Filter Full Flow.....	C-5713
		Oil Filter Full Flow.....	C-57430	Oil Filter Full Flow.....	C-5734
C15 D5 (GENERATORS) KUBOTA D1703		C450 D5EB (GENERATORS) CUMMINS QSZ13-G7		(ENGINES) CUMMINS ISL9 EURO 5 , TO-2009	
Air Filter Primary.....	A-8506	Air Filter.....	A-44210	Fuel Filter.....	FC-5713
Air Filter Set.....	A-8506-S	Oil Filter Full Flow.....	C-57430	Fuel/Water Separator.....	SFC-5509-10
Fuel Filter.....	F-5210	C450 D5EB (GENERATORS) CUMMINS QSZ13-G7		Oil Filter Combination.....	C-5707
		Air Filter.....	A-44210		
C150 D5 (GENERATORS) CUMMINS 6BTA5.9-G2		Oil Filter Full Flow.....	C-57430	(ENGINES) CUMMINS ISX15 , TO-2009	
Air Filter Primary.....	A-5541	C55D5 (GENERATORS)		Coolant Filter.....	WC-57010
Air Filter Primary.....	A-5541M	Air Filter Primary.....	A-8506	Coolant Filter.....	WC-57020
Air Filter Primary.....	A-76231	Air Filter Set.....	A-8506-S	Fuel/Water Separator.....	SFC-5521
Air Filter Secondary.....	A-5540				
Air Filter Set.....	A-5541M-S	C66 D5 (GENERATORS) CUMMINS 53.8 G7 , 3800		(ENGINES) CUMMINS X15 , 2017	
Fuel/Water Separator.....	SFC-5708	Oil Filter By Pass.....	C-57420	Fuel/Water Separator.....	SF-79080
		COMFORT GUARD (ENGINES) KUBOTA Z482		Oil Filter Full Flow.....	C-57430
C15 D6 (GENERATORS) KUBOTA D1703		Air Filter Primary.....	A-8504		
Air Filter Primary.....	A-8506	Fuel Filter.....	FS-1004	(ENGINES) CUMMINS ISX15 / MEETS EPA10 STANDARDS , 2015	
Air Filter Set.....	A-8506-S	Oil Filter Full Flow.....	C-8805	Coolant Filter.....	WC-57010
Fuel Filter.....	F-5210			Coolant Filter.....	WC-57020
		ES17D5 (GENERATORS) CUMMINS X1.7G1		Fuel/Water Separator.....	SF-79080
C20 D5 P (GENERATORS) CUMMINS X2.5G1		Air Filter.....	A-44200	Oil Filter Full Flow.....	C-57430
Oil Filter Full Flow.....	C-57400	Fuel/Water Separator.....	SFC-5708		
		ES22D5 (GENERATORS)		(ENGINES) CUMMINS ISB6.7 , 2010-UP	
C22 D5 (GENERATORS) CUMMINS B3.3-G1		Air Filter.....	A-44200	Oil Filter Full Flow.....	C-5708
Air Filter Primary.....	A-8506			(ENGINES) CUMMINS ISC8.3 , 2010-UP	
Air Filter Set.....	A-8506-S	ES28D5 (GENERATORS) CUMMINS X2.5G2		Coolant Filter.....	WC-5705
		Air Filter.....	A-44200	Fuel Filter.....	FC-57280
C2250 D5 (GENERATORS) CUMMINS QSK60-G4		Fuel/Water Separator.....	SFC-5708	Oil Filter Combination.....	C-5707
Coolant Filter.....	WC-5713				
Fuel/Water Separator.....	SFC-5601-02			(ENGINES) CUMMINS ISL9 , 2010-UP	
				Coolant Filter.....	WC-5705
				Fuel Filter.....	FC-57280

Sakura Filter

ENGINE APPLICATION

MODEL/APPLICATION	SAKURA NO	MODEL/APPLICATION	SAKURA NO	MODEL/APPLICATION	SAKURA NO
CUMMINS		CUMMINS		CUMMINS	
<i>(ENGINES)</i> CUMMINS ISL9 , 2010-UP		<i>(ENGINES)</i> CUMMINS 6CTA8.3		Coolant Filter..... WC-5711	
Oil Filter Combination.....	C-5707	Coolant Filter.....	WC-5705	Fuel Filter.....	FC-5721
<i>(ENGINES)</i> CUMMINS ISX11.9 , 2010-UP		Coolant Filter.....	WC-5711	Fuel/Water Separator.....	SFC-5709-10
Coolant Filter.....	WC-57010	Fuel Filter.....	FS-5701	Oil Filter Combination.....	C-5707
Coolant Filter.....	WC-57020	Fuel Filter Secondary.....	FC-7903	Oil Filter Combination.....	C-5723
Fuel/Water Separator.....	SF-79080	Fuel/Water Separator.....	SFC-5706	<i>(ENGINES)</i> CUMMINS NT-855	
<i>(ENGINES)</i> CUMMINS ISX15 , 2010-UP		Fuel/Water Separator.....	SFC-5708	Coolant Filter.....	WC-5705
Coolant Filter.....	WC-57010	Oil Filter Combination.....	C-5703	Fuel Filter.....	FC-5720
Fuel/Water Separator.....	SF-79080	<i>(ENGINES)</i> CUMMINS ISB5.9		Fuel/Water Separator.....	SFC-5705
<i>(ENGINES)</i> CUMMINS 4B3.9		Fuel/Water Separator.....	SFC-5706	Fuel/Water Separator Secondary..	SFC-1905-10
Fuel Filter Secondary.....	FC-7903	Oil Filter Full Flow.....	C-5708	Oil Filter By Pass.....	C-5718
Fuel/Water Separator.....	SFC-5706	<i>(ENGINES)</i> CUMMINS KT-1150		Oil Filter Combination.....	C-5723
Fuel/Water Separator.....	SFC-5708	Coolant Filter.....	WC-5705	Oil Filter Full Flow.....	C-5715
Oil Filter Full Flow.....	C-5703	Fuel Filter.....	FC-5702	Oil Filter Full Flow.....	O-5702
<i>(ENGINES)</i> CUMMINS 4BT3.9		Fuel Filter.....	FC-5721	<i>(ENGINES)</i> CUMMINS NTA-855	
Fuel Filter Secondary.....	FC-7903	Fuel/Water Separator.....	SFC-5705	Coolant Filter.....	WC-5705
Fuel/Water Separator.....	SFC-5706	Oil Filter By Pass.....	C-5718	Fuel Filter.....	FC-5720
Fuel/Water Separator.....	SFC-5708	Oil Filter Full Flow.....	C-5715	Fuel/Water Separator.....	SFC-5705
Oil Filter Full Flow.....	C-5703	<i>(ENGINES)</i> CUMMINS KTA-1150		Fuel/Water Separator Secondary..	SFC-1905-10
<i>(ENGINES)</i> CUMMINS 4BTA3.9		Coolant Filter.....	WC-5705	Oil Filter By Pass.....	C-5718
Fuel Filter Secondary.....	FC-7903	Fuel Filter.....	FC-5702	Oil Filter Combination.....	C-5723
Fuel/Water Separator.....	SFC-5706	Fuel/Water Separator.....	SFC-5705	Oil Filter Full Flow.....	C-5715
Fuel/Water Separator.....	SFC-5708	Oil Filter By Pass.....	C-5718	Oil Filter Full Flow.....	O-5702
Oil Filter Full Flow.....	C-5703	Oil Filter Full Flow.....	C-5715	<i>(ENGINES)</i> CUMMINS QSB 5.9	
<i>(ENGINES)</i> CUMMINS 6B5.9		<i>(ENGINES)</i> CUMMINS KTA-19C		Fuel/Water Separator.....	EF-5705-10
Fuel Filter Secondary.....	FC-7903	Coolant Filter.....	WC-5705	Fuel/Water Separator.....	SF-57010
Fuel/Water Separator.....	SFC-5706	Fuel Filter.....	FC-5720	Oil Filter Full Flow.....	C-5708
Fuel/Water Separator.....	SFC-5708	Fuel/Water Separator.....	SFC-5705	<i>(ENGINES)</i> CUMMINS QSK19	
Oil Filter Full Flow.....	C-5704	Oil Filter By Pass.....	C-5718	Coolant Filter.....	WC-5703
<i>(ENGINES)</i> CUMMINS 6BT5.9		Oil Filter Full Flow.....	C-5715	Fuel Filter.....	FC-57290
Fuel Filter Secondary.....	FC-7903	<i>(ENGINES)</i> CUMMINS L10		<i>(ENGINES)</i> CUMMINS V-378	
Fuel/Water Separator.....	SFC-5706	Coolant Filter.....	WC-5705	Coolant Filter.....	WC-5705
Fuel/Water Separator.....	SFC-5708	Coolant Filter.....	WC-5713	Fuel Filter.....	FC-5702
Oil Filter Full Flow.....	C-5704	Fuel Filter.....	FC-5720	Fuel Filter.....	FC-5720
<i>(ENGINES)</i> CUMMINS 6BTA5.9		Fuel Filter.....	FC-5721	Fuel/Water Separator.....	SFC-5705
Fuel Filter Secondary.....	FC-7903	Fuel/Water Separator.....	SFC-5705	Fuel/Water Separator Secondary..	SFC-1905-10
Fuel/Water Separator.....	SFC-5706	Fuel/Water Separator Secondary..	SFC-1905-10	Oil Filter By Pass.....	C-5718
Fuel/Water Separator.....	SFC-5708	Oil Filter By Pass.....	C-5718	Oil Filter By Pass.....	O-5705
Oil Filter Full Flow.....	C-5704	Oil Filter Full Flow.....	C-5715	Oil Filter Full Flow.....	O-5703
<i>(ENGINES)</i> CUMMINS 6CT8.3		<i>(ENGINES)</i> CUMMINS M11		<i>(ENGINES)</i> CUMMINS V-504	
Coolant Filter.....	WC-5705	Coolant Filter.....	WC-5703	Coolant Filter.....	WC-5705
Coolant Filter.....	WC-5711	Coolant Filter.....	WC-5705	Fuel Filter.....	FC-5702
Fuel Filter.....	FS-5701	Coolant Filter.....	WC-5706	Fuel Filter.....	FC-5720
Fuel Filter Secondary.....	FC-7903	Fuel/Water Separator.....	SFC-5709-10	Fuel/Water Separator.....	SFC-5705
Fuel/Water Separator.....	SFC-5706	Oil Filter Combination.....	C-5707	Fuel/Water Separator Secondary..	SFC-1905-10
Fuel/Water Separator.....	SFC-5708	Oil Filter Combination.....	C-5723	Oil Filter By Pass.....	C-5718
Oil Filter Combination.....	C-5723	<i>(ENGINES)</i> CUMMINS N14		Oil Filter By Pass.....	O-5705
<i>(ENGINES)</i> CUMMINS N14		Coolant Filter.....	WC-5705	Oil Filter Full Flow.....	O-5703
Coolant Filter.....	WC-5705	<i>(ENGINES)</i> CUMMINS V-555			
Fuel Filter.....	FS-5701	Coolant Filter.....	WC-5705	Coolant Filter.....	WC-5705
Fuel Filter Secondary.....	FC-7903	<i>(ENGINES)</i> CUMMINS V-555			
Fuel/Water Separator.....	SFC-5706	Coolant Filter..... WC-5705			
Fuel/Water Separator.....	SFC-5708	Fuel Filter..... FC-5702			
Oil Filter Combination.....	C-5723	Fuel Filter..... FC-5720			
<i>(ENGINES)</i> CUMMINS N14		Fuel/Water Separator..... SFC-5705			
Coolant Filter.....	WC-5705	Fuel/Water Separator Secondary.. SFC-1905-10			
<i>(ENGINES)</i> CUMMINS N14		Oil Filter By Pass..... C-5718			
Coolant Filter.....	WC-5705	Oil Filter By Pass..... O-5705			
Fuel Filter.....	FS-5701	Oil Filter Full Flow..... O-5703			
Fuel Filter Secondary.....	FC-7903	<i>(ENGINES)</i> CUMMINS V-555			
Fuel/Water Separator.....	SFC-5706	Coolant Filter..... WC-5705			
Fuel/Water Separator.....	SFC-5708	Fuel Filter..... FC-5702			
Oil Filter Combination.....	C-5723	Fuel Filter..... FC-5720			

Sakura Filter

ENGINE APPLICATION

MODEL/APPLICATION	SAKURA NO	MODEL/APPLICATION	SAKURA NO	MODEL/APPLICATION	SAKURA NO
CUMMINS		CUMMINS		CUMMINS	
<i>(ENGINES)</i> CUMMINS KTA-19		<i>(ENGINES)</i> CUMMINS QSM11TIER 2		<i>(ENGINES)</i> CUMMINS 3B2.9	
Coolant Filter.....	WC-5703	Fuel/Water Separator.....	SFC-5709-10	Oil Filter Full Flow.....	C-5703
Fuel Filter.....	FC-5721	<i>(ENGINES)</i> CUMMINS QSM11TIER 3		<i>(ENGINES)</i> CUMMINS 4A2.0 (S/N: TIER 2-UP)	
Fuel Filter.....	FC-57290	Fuel/Water Separator.....	SFC-5709-10	Fuel/Water Separator.....	SFC-7924
<i>(ENGINES)</i> CUMMINS QSX15		<i>(ENGINES)</i> CUMMINS 6CTAA8.3		<i>(ENGINES)</i> CUMMINS 4A2.0-G1 (S/N: TIER 2-UP)	
Coolant Filter.....	WC-57010	Coolant Filter.....	WC-5705	Fuel/Water Separator.....	SFC-7924
Coolant Filter.....	WC-57020	Fuel Filter Secondary.....	FC-7903	<i>(ENGINES)</i> CUMMINS 4A2.3 (S/N: TIER 2-UP)	
Fuel/Water Separator.....	SFC-5521	Fuel/Water Separator.....	SFC-5706	Fuel/Water Separator.....	SFC-7924
<i>(ENGINES)</i> CUMMINS ISLE - EURO 4		Oil Filter Combination.....	C-5723	<i>(ENGINES)</i> CUMMINS 4A2.3-G1 (S/N: TIER 2-UP)	
Coolant Filter.....	WC-5712	<i>(ENGINES)</i> CUMMINS A2000		Fuel/Water Separator.....	SFC-7924
Fuel Filter.....	FC-5713	Fuel/Water Separator.....	SFC-7924	<i>(ENGINES)</i> CUMMINS 4AT2.3 (S/N: TIER 2-UP)	
Fuel/Water Separator.....	SFC-5509-10	<i>(ENGINES)</i> CUMMINS A2300		Fuel/Water Separator.....	SFC-7924
Oil Filter Combination.....	C-5707	Fuel/Water Separator.....	SFC-7924	<i>(ENGINES)</i> CUMMINS 4AT2.3-G1 (S/N: TIER 2-UP)	
<i>(ENGINES)</i> CUMMINS M11-CTIER 1		<i>(ENGINES)</i> CUMMINS Q5B4.5		<i>(ENGINES)</i> CUMMINS 4AT2.3-G2 (S/N: TIER 2-UP)	
Fuel/Water Separator.....	SFC-5709-10	Fuel Filter.....	FC-45010	Fuel/Water Separator.....	SFC-7924
<i>(ENGINES)</i> CUMMINS M11-G1		Fuel Filter.....	FC-5725	<i>(ENGINES)</i> CUMMINS 4B (S/N: TIER 2-UP)	
Coolant Filter.....	WC-5703	Fuel/Water Separator.....	SFC-5711	Fuel/Water Separator.....	SFC-55200
Coolant Filter.....	WC-5705	Oil Filter Full Flow.....	C-5708	<i>(ENGINES)</i> CUMMINS 4B3.3 (S/N: TIER 1-UP)	
Coolant Filter.....	WC-5706	Oil Filter Full Flow.....	C-5713	Fuel Filter.....	FC-1801
Fuel/Water Separator.....	SFC-5709-10	Oil Filter Full Flow.....	C-5734	Oil Filter Full Flow.....	C-56191
Oil Filter Combination.....	C-5723	<i>(ENGINES)</i> CUMMINS QSL9		<i>(ENGINES)</i> CUMMINS 4B3.3-G1 (S/N: TIER 1-UP)	
<i>(ENGINES)</i> CUMMINS M11-G2		Coolant Filter.....	WC-5703	Fuel Filter.....	FC-1801
Coolant Filter.....	WC-5703	Fuel/Water Separator.....	SFC-5711	Oil Filter Full Flow.....	C-56191
Coolant Filter.....	WC-5705	Oil Filter Combination.....	C-5707	<i>(ENGINES)</i> CUMMINS 4B3.9-G	
Coolant Filter.....	WC-5706	<i>(ENGINES)</i> CUMMINS A1400		Air Filter.....	AH-5706
Fuel/Water Separator.....	SFC-5709-10	Fuel/Water Separator.....	SFC-7924	Fuel Filter.....	FS-5701
Oil Filter Combination.....	C-5723	<i>(ENGINES)</i> CUMMINS A1700		Fuel Filter Secondary.....	FC-7903
<i>(ENGINES)</i> CUMMINS N14-M		Fuel/Water Separator.....	SFC-7924	Fuel/Water Separator.....	SFC-5706
Fuel/Water Separator.....	SFC-5709-10	<i>(ENGINES)</i> CUMMINS ISLE		Fuel/Water Separator.....	SFC-5708
<i>(ENGINES)</i> CUMMINS N14PLUS		Coolant Filter.....	WC-5712	Oil Filter Full Flow.....	C-5703
Fuel/Water Separator.....	SFC-5709-10	Fuel Filter.....	FC-5713	<i>(ENGINES)</i> CUMMINS 4B3.9-G2	
<i>(ENGINES)</i> CUMMINS QSK1937255463		Fuel/Water Separator.....	SFC-5509-10	Air Filter.....	AH-5706
Fuel/Water Separator.....	SFC-5709-10	Oil Filter Combination.....	C-5707	Fuel Filter.....	FS-5701
<i>(ENGINES)</i> CUMMINS QSK19TIER 1		<i>(ENGINES)</i> CUMMINS 3A1.4 (S/N: TIER 2-UP)		Fuel Filter Secondary.....	FC-7903
Fuel/Water Separator.....	SFC-5709-10	Fuel/Water Separator.....	SFC-7924	Fuel/Water Separator.....	SFC-5706
<i>(ENGINES)</i> CUMMINS QSK19TIER 1/STAGE 1		<i>(ENGINES)</i> CUMMINS 3A1.4-G1 (S/N: TIER 2-UP)		Fuel/Water Separator.....	SFC-5708
Fuel/Water Separator.....	SFC-5709-10	Fuel/Water Separator.....	SFC-7924	Oil Filter Full Flow.....	C-5703
<i>(ENGINES)</i> CUMMINS QSK19TIER 2		<i>(ENGINES)</i> CUMMINS 3A1.7 (S/N: TIER 2-UP)		<i>(ENGINES)</i> CUMMINS 4BT3.3-G2 (S/N: TIER 1-UP)	
Fuel/Water Separator.....	SFC-5709-10	Fuel/Water Separator.....	SFC-7924	Fuel Filter.....	FC-1801
<i>(ENGINES)</i> CUMMINS QSK19TIER 2/STAGE II		<i>(ENGINES)</i> CUMMINS 3A1.7-G1 (S/N: TIER 2-UP)		Oil Filter Full Flow.....	C-56191
Fuel/Water Separator.....	SFC-5709-10	Fuel/Water Separator.....	SFC-7924		

Sakura Filter

ENGINE APPLICATION

MODEL/APPLICATION	SAKURA NO	MODEL/APPLICATION	SAKURA NO	MODEL/APPLICATION	SAKURA NO
CUMMINS		CUMMINS		CUMMINS	
<i>(ENGINES)</i> CUMMINS 6BTA45.9-G1		Fuel/Water Separator Full Flow.....	SFC-7907	<i>(ENGINES)</i> CUMMINS EURO 2 B (S/N: 6 CYLINDER-UP)	
Fuel Filter.....	FS-5701	Oil Filter Full Flow.....	C-56191	Oil Filter Full Flow.....	C-5704
Fuel/Water Separator.....	SFC-5706	<i>(ENGINES)</i> CUMMINS B3.3NA (S/N: TIER 3-UP)		<i>(ENGINES)</i> CUMMINS EURO 2 C	
Oil Filter Full Flow.....	C-5714	Fuel Filter.....	FC-1108	Oil Filter Combination.....	C-5707
<i>(ENGINES)</i> CUMMINS 6CT8.3-G		Fuel Filter.....	FC-1801	Oil Filter Combination.....	C-5723
Coolant Filter.....	WC-5705	Fuel Filter.....	FS-5701	<i>(ENGINES)</i> CUMMINS G12	
Fuel Filter Secondary.....	FC-7903	Fuel/Water Separator Full Flow.....	SFC-7907	Coolant Filter.....	WC-5711
Fuel/Water Separator.....	SFC-5706	Oil Filter Full Flow.....	C-56191	Coolant Filter.....	WC-5712
Oil Filter Combination.....	C-5723	<i>(ENGINES)</i> CUMMINS B3.3T (S/N: TIER 2-UP)		Oil Filter Full Flow.....	O-5702
<i>(ENGINES)</i> CUMMINS 6CT8.3-G2		Fuel Filter.....	FC-1108	<i>(ENGINES)</i> CUMMINS G3.9	
Coolant Filter.....	WC-5705	Fuel Filter.....	FC-1801	Oil Filter Full Flow.....	O-5702
Fuel Filter Secondary.....	FC-7903	Fuel Filter.....	FS-5701	<i>(ENGINES)</i> CUMMINS G5.9	
Fuel/Water Separator.....	SFC-5706	Fuel/Water Separator Full Flow.....	SFC-7907	Oil Filter Full Flow.....	O-5702
Oil Filter Combination.....	C-5723	Oil Filter Full Flow.....	C-56191	<i>(ENGINES)</i> CUMMINS G8.3	
<i>(ENGINES)</i> CUMMINS 6CTA8.3-G		<i>(ENGINES)</i> CUMMINS B3.3T (S/N: TIER 3-UP)		Oil Filter Full Flow.....	O-5702
Coolant Filter.....	WC-5705	Fuel Filter.....	FC-1108	<i>(ENGINES)</i> CUMMINS G8.3	
Fuel Filter Secondary.....	FC-7903	Fuel Filter.....	FC-1801	Coolant Filter.....	WC-5711
Fuel/Water Separator.....	SFC-5706	Fuel Filter.....	FS-5701	Coolant Filter.....	WC-5712
Oil Filter Combination.....	C-5723	Fuel/Water Separator Full Flow.....	SFC-7907	Oil Filter Full Flow.....	O-5702
<i>(ENGINES)</i> CUMMINS 6CTA8.3-G2		Oil Filter Full Flow.....	C-56191	<i>(ENGINES)</i> CUMMINS G5.9	
Coolant Filter.....	WC-5705	<i>(ENGINES)</i> CUMMINS B3.3TAA (S/N: TIER 3-UP)		Oil Filter Full Flow.....	O-5702
Fuel Filter Secondary.....	FC-7903	Fuel Filter.....	FC-1108	<i>(ENGINES)</i> CUMMINS G8.3	
Fuel/Water Separator.....	SFC-5706	Fuel Filter.....	FC-1801	Coolant Filter.....	WC-5711
Oil Filter Combination.....	C-5723	Fuel Filter.....	FS-5701	Coolant Filter.....	WC-5712
<i>(ENGINES)</i> CUMMINS 6CTAA8.3-G2		Fuel/Water Separator Full Flow.....	SFC-7907	Oil Filter Full Flow.....	O-5702
Coolant Filter.....	WC-5705	Oil Filter Full Flow.....	C-56191	<i>(ENGINES)</i> CUMMINS G855	
Fuel Filter Secondary.....	FC-7903	<i>(ENGINES)</i> CUMMINS B3.3TAA (S/N: TIER 3-UP)		Air Filter.....	AH-5701
Fuel/Water Separator.....	SFC-5706	Fuel Filter.....	FC-1108	Air Filter.....	AH-5709
Oil Filter Combination.....	C-5723	Fuel Filter.....	FC-1801	Coolant Filter.....	WC-5703
<i>(ENGINES)</i> CUMMINS A2300T		Fuel Filter.....	FS-5701	Coolant Filter.....	WC-5712
Fuel/Water Separator.....	SFC-7924	Fuel/Water Separator Full Flow.....	SFC-7907	Oil Filter Combination.....	C-5707
<i>(ENGINES)</i> CUMMINS A900		Oil Filter Full Flow.....	C-56191	Oil Filter Full Flow.....	C-5715
Fuel/Water Separator.....	SFC-7924	<i>(ENGINES)</i> CUMMINS B3.9TAA (S/N: TIER 2-UP)		<i>(ENGINES)</i> CUMMINS GTA12	
<i>(ENGINES)</i> CUMMINS B3.3-G1		Fuel Filter.....	FS-5701	Air Filter.....	AH-5701
Fuel Filter.....	FC-1108	<i>(ENGINES)</i> CUMMINS B4.5NA (S/N: TIER 2-UP)		Air Filter.....	AH-5709
Fuel Filter.....	FC-1801	Fuel Filter.....	FS-5701	Coolant Filter.....	WC-5712
Oil Filter Full Flow.....	C-56191	Fuel/Water Separator Full Flow.....	SFC-7907	Oil Filter Full Flow.....	O-5702
<i>(ENGINES)</i> CUMMINS B3.3-G2		Oil Filter Full Flow.....	C-56191	<i>(ENGINES)</i> CUMMINS GTA19	
Fuel Filter.....	FC-1108	<i>(ENGINES)</i> CUMMINS B5.9TAA (S/N: TIER 2-UP)		Coolant Filter.....	WC-5703
Fuel Filter.....	FC-1801	Fuel Filter.....	FS-5701	Oil Filter Combination.....	C-5723
Oil Filter Full Flow.....	C-56191	Oil Filter Full Flow.....	C-5714	Oil Filter Full Flow.....	C-5715
<i>(ENGINES)</i> CUMMINS B3.3NA (S/N: TIER 2-UP)		<i>(ENGINES)</i> CUMMINS C GAS PLUS		Oil Filter Full Flow.....	C-5715
Fuel Filter.....	FC-1108	Coolant Filter.....	WC-5705	<i>(ENGINES)</i> CUMMINS GTA28	
Fuel Filter.....	FC-1801	Coolant Filter.....	WC-5711	Coolant Filter.....	WC-5703
Fuel Filter.....	FS-5701	Oil Filter Combination.....	C-5707	Oil Filter Combination.....	C-5723
<i>(ENGINES)</i> CUMMINS B3.3NA (S/N: TIER 2-UP)		<i>(ENGINES)</i> CUMMINS C8.3 (S/N: TIER 2-UP)		Oil Filter Full Flow.....	C-5715
Fuel Filter.....	FC-1108	Fuel Filter.....	FS-5701	<i>(ENGINES)</i> CUMMINS GTA5.9	
Fuel Filter.....	FC-1801	Fuel/Water Separator.....	SFC-5706	Oil Filter Full Flow.....	O-5702
Fuel Filter.....	FS-5701	Fuel/Water Separator.....	SFC-5708	<i>(ENGINES)</i> CUMMINS GTA8.3	
<i>(ENGINES)</i> CUMMINS B3.3NA (S/N: TIER 2-UP)		Oil Filter Combination.....	C-57390	Coolant Filter.....	WC-5711
Fuel Filter.....	FC-1108	Oil Filter Combination.....	C-7927	Oil Filter Combination.....	C-5723
Fuel Filter.....	FC-1801				
Fuel Filter.....	FS-5701				

Sakura Filter

ENGINE APPLICATION

MODEL/APPLICATION	SAKURA NO	MODEL/APPLICATION	SAKURA NO	MODEL/APPLICATION	SAKURA NO
CUMMINS		CUMMINS		CUMMINS	
<i>(ENGINES)</i> CUMMINS GTA8.3-P1		Fuel Filter..... FC-45010		<i>(ENGINES)</i> CUMMINS ISL07	
Coolant Filter..... WC-5711		Fuel Filter..... FC-5725		Coolant Filter..... WC-5705	
Coolant Filter..... WC-5712		Fuel/Water Separator..... SFC-5711		Fuel Filter..... FC-57280	
Oil Filter Full Flow..... 0-5702		Oil Filter Full Flow..... C-5713		Fuel/Water Separator..... SFC-5509-10	
<i>(ENGINES)</i> CUMMINS GTA8.3-P2		Oil Filter Full Flow..... C-5734		Oil Filter Combination..... C-5707	
Coolant Filter..... WC-5711		<i>(ENGINES)</i> CUMMINS ISBE EURO 4 6 CYL		Oil Filter Combination..... C-57390	
Coolant Filter..... WC-5712		Fuel Filter..... FC-5725		<i>(ENGINES)</i> CUMMINS ISM02	
Oil Filter Full Flow..... 0-5702		Oil Filter Full Flow..... C-5713		Coolant Filter..... WC-57170	
<i>(ENGINES)</i> CUMMINS GTA855		Oil Filter Full Flow..... C-5734		Coolant Filter..... WC-57160	
Air Filter..... AH-5701		<i>(ENGINES)</i> CUMMINS ISC03		Coolant Filter..... WC-5712	
Coolant Filter..... WC-5712		Coolant Filter..... WC-5703		Coolant Filter..... WC-5705	
Oil Filter Combination..... C-5707		Coolant Filter..... WC-5712		Coolant Filter..... WC-5705	
Oil Filter Combination..... C-5723		Fuel Filter..... FC-5713		Fuel/Water Separator..... SFC-5509-10	
<i>(ENGINES)</i> CUMMINS GTA855A		Fuel/Water Separator..... SFC-5509-10		<i>(ENGINES)</i> CUMMINS ISM07	
Air Filter..... AH-5701		Oil Filter Combination..... C-5707		Coolant Filter..... WC-57170	
Air Filter..... AH-5709		<i>(ENGINES)</i> CUMMINS ISC05		Coolant Filter..... WC-57160	
Coolant Filter..... WC-5703		Coolant Filter..... WC-5703		Coolant Filter..... WC-5705	
Coolant Filter..... WC-5712		Coolant Filter..... WC-5712		Coolant Filter..... WC-5705	
Oil Filter Combination..... C-5707		Fuel Filter..... FC-5713		Fuel/Water Separator..... SFC-5509-10	
Oil Filter Full Flow..... C-5715		Fuel/Water Separator..... SFC-5509-10		<i>(ENGINES)</i> CUMMINS ISM11E4	
<i>(ENGINES)</i> CUMMINS GTA855B		Oil Filter Combination..... C-5707		Fuel/Water Separator..... SFC-5509-10	
Air Filter..... AH-5701		<i>(ENGINES)</i> CUMMINS ISC07		<i>(ENGINES)</i> CUMMINS ISX02	
Air Filter..... AH-5709		Coolant Filter..... WC-5705		Coolant Filter..... WC-57020	
Coolant Filter..... WC-5703		Fuel Filter..... FC-57280		Coolant Filter..... WC-57010	
Coolant Filter..... WC-5712		Fuel/Water Separator..... SFC-5509-10		Fuel Filter..... FC-5726	
Oil Filter Combination..... C-5707		Oil Filter Combination..... C-5707		Fuel Filter..... FC-5714	
Oil Filter Full Flow..... C-5715		Oil Filter Combination..... C-57390		Fuel Filter..... FC-5711	
<i>(ENGINES)</i> CUMMINS ISB02		<i>(ENGINES)</i> CUMMINS ISCE (S/N: EURO 3-UP)		<i>(ENGINES)</i> CUMMINS K1500	
Oil Filter Full Flow..... C-5708		Oil Filter Combination..... C-5707		Oil Filter By Pass..... C-5718	
<i>(ENGINES)</i> CUMMINS ISB07		<i>(ENGINES)</i> CUMMINS ISL G		Oil Filter Full Flow..... C-5715	
Oil Filter Full Flow..... C-5708		Coolant Filter..... WC-5705		<i>(ENGINES)</i> CUMMINS K2000	
<i>(ENGINES)</i> CUMMINS ISB4		Coolant Filter..... WC-5712		Oil Filter By Pass..... C-5718	
Fuel Filter..... FC-5725		<i>(ENGINES)</i> CUMMINS ISL03		Oil Filter Full Flow..... C-5701	
Oil Filter Full Flow..... C-5713		Coolant Filter..... WC-5703		<i>(ENGINES)</i> CUMMINS K38	
Oil Filter Full Flow..... C-5734		Coolant Filter..... WC-5705		Oil Filter By Pass..... C-5718	
<i>(ENGINES)</i> CUMMINS ISB4.5 EURO 5		Coolant Filter..... WC-5712		Oil Filter Full Flow..... C-5715	
Fuel Filter..... FC-45010		Fuel Filter..... FC-5713		<i>(ENGINES)</i> CUMMINS K50	
Fuel Filter..... FC-5725		Fuel Filter..... FC-5713		Oil Filter By Pass..... C-5718	
Fuel/Water Separator..... SFC-5711		Fuel/Water Separator..... SFC-5509-10		Oil Filter Full Flow..... C-5701	
Oil Filter Full Flow..... C-5713		Oil Filter Combination..... C-5707		<i>(ENGINES)</i> CUMMINS K-6 SERIES KT-450	
Oil Filter Full Flow..... C-5734		<i>(ENGINES)</i> CUMMINS ISL05		Coolant Filter..... WC-5705	
<i>(ENGINES)</i> CUMMINS ISB99		Coolant Filter..... WC-5703		Fuel Filter..... FC-5720	
Fuel/Water Separator Secondary... SFC-1905-10		Coolant Filter..... WC-5705		Fuel/Water Separator..... SFC-5705	
Oil Filter Full Flow..... C-5708		Coolant Filter..... WC-5712		Oil Filter By Pass..... C-5718	
<i>(ENGINES)</i> CUMMINS ISBE EURO 4 4 CYL		Fuel Filter..... FC-5713		Oil Filter Full Flow..... C-5715	
		Fuel/Water Separator..... SFC-5509-10		<i>(ENGINES)</i> CUMMINS KTA19-G1	
		Oil Filter Combination..... C-5707		Coolant Filter..... WC-5705	

Sakura Filter

ENGINE APPLICATION

MODEL/APPLICATION	SAKURA NO
CUMMINS	
<i>(ENGINES)</i>	
CUMMINS KTA19-G1	
Fuel Filter.....	FC-5702
Fuel/Water Separator.....	SFC-5705
Oil Filter By Pass.....	C-5718
Oil Filter Full Flow.....	C-5715
<i>(ENGINES)</i>	
CUMMINS KTA19-G2	
Coolant Filter.....	WC-5705
Fuel Filter.....	FC-5702
Fuel/Water Separator.....	SFC-5705
Oil Filter By Pass.....	C-5718
Oil Filter Full Flow.....	C-5715
<i>(ENGINES)</i>	
CUMMINS KTA19-G3	
Coolant Filter.....	WC-5705
Fuel Filter.....	FC-5702
Fuel/Water Separator.....	SFC-5705
Oil Filter By Pass.....	C-5718
Oil Filter Full Flow.....	C-5715
<i>(ENGINES)</i>	
CUMMINS KTA19-G4	
Coolant Filter.....	WC-5705
Fuel Filter.....	FC-5702
Fuel/Water Separator.....	SFC-5705
Oil Filter By Pass.....	C-5718
Oil Filter Full Flow.....	C-5715
<i>(ENGINES)</i>	
CUMMINS KTA19GC	
Coolant Filter.....	WC-5703
Oil Filter Combination.....	C-5723
<i>(ENGINES)</i>	
CUMMINS KTA19GCSLB	
Coolant Filter.....	WC-5703
Oil Filter Combination.....	C-5723
<i>(ENGINES)</i>	
CUMMINS KTA-3067	
Coolant Filter.....	WC-5711
Fuel Filter.....	FC-5703
Fuel/Water Separator.....	SFC-5601-02
Fuel/Water Separator.....	SFC-5707
Oil Filter By Pass.....	C-5718
Oil Filter Full Flow.....	C-5701
Oil Filter Full Flow.....	C-5715
<i>(ENGINES)</i>	
CUMMINS KTA-3067 (S/N: 1000KVA-UP)	
Fuel Filter.....	F-5701
Oil Filter Full Flow.....	O-5702
<i>(ENGINES)</i>	
CUMMINS KTA-3067C	
Coolant Filter.....	WC-5711
Fuel Filter.....	FC-5703
Fuel/Water Separator.....	SFC-5707
Oil Filter By Pass.....	C-5718
Oil Filter Full Flow.....	C-5701
<i>(ENGINES)</i>	
CUMMINS KTA38-G1	

MODEL/APPLICATION	SAKURA NO
CUMMINS	
Coolant Filter.....	WC-5703
Coolant Filter.....	WC-5711
Fuel Filter.....	FC-5703
Fuel/Water Separator.....	SFC-5601-02
Fuel/Water Separator.....	SFC-5707
Oil Filter By Pass.....	C-5718
Oil Filter Full Flow.....	C-5715
<i>(ENGINES)</i>	
CUMMINS KTA38-G2	
Coolant Filter.....	WC-5703
Coolant Filter.....	WC-5711
Fuel Filter.....	FC-5703
Fuel/Water Separator.....	SFC-5601-02
Fuel/Water Separator.....	SFC-5707
Oil Filter By Pass.....	C-5718
Oil Filter Full Flow.....	C-5715
<i>(ENGINES)</i>	
CUMMINS KTA38-G3	
Coolant Filter.....	WC-5703
Coolant Filter.....	WC-5712
Fuel/Water Separator.....	SFC-5601-02
Oil Filter By Pass.....	C-5718
Oil Filter Full Flow.....	C-5701
Oil Filter Full Flow.....	C-5715
<i>(ENGINES)</i>	
CUMMINS KTA38-G4	
Coolant Filter.....	WC-5703
Coolant Filter.....	WC-5711
Fuel Filter.....	FC-5703
Fuel/Water Separator.....	SFC-5601-02
Fuel/Water Separator.....	SFC-5707
Oil Filter By Pass.....	C-5718
Oil Filter Full Flow.....	C-5715
<i>(ENGINES)</i>	
CUMMINS KTA38-G5 (S/N: 1000KVA-UP)	
Fuel Filter.....	F-5701
Oil Filter Full Flow.....	O-5702
<i>(ENGINES)</i>	
CUMMINS KTA38-G6	
Coolant Filter.....	WC-5703
Coolant Filter.....	WC-5712
Fuel/Water Separator.....	SFC-5601-02
Oil Filter By Pass.....	C-5718
Oil Filter Full Flow.....	C-5701
Oil Filter Full Flow.....	C-5715
<i>(ENGINES)</i>	
CUMMINS KTA38-G7	
Coolant Filter.....	WC-5703
Coolant Filter.....	WC-5712

MODEL/APPLICATION	SAKURA NO
CUMMINS	
Fuel/Water Separator.....	SFC-5601-02
Oil Filter By Pass.....	C-5718
Oil Filter Full Flow.....	C-5701
Oil Filter Full Flow.....	C-5715
<i>(ENGINES)</i>	
CUMMINS KTA38GC	
Coolant Filter.....	WC-5703
Oil Filter Full Flow.....	C-5715
<i>(ENGINES)</i>	
CUMMINS KTA50-C	
Coolant Filter.....	WC-5711
Fuel Filter.....	FC-5703
Fuel/Water Separator.....	SFC-5707
Oil Filter By Pass.....	C-5718
Oil Filter Full Flow.....	C-5701
<i>(ENGINES)</i>	
CUMMINS KTA50-G1	
Coolant Filter.....	WC-5703
Coolant Filter.....	WC-5711
Coolant Filter.....	WC-5712
Fuel/Water Separator.....	SFC-5601-02
Oil Filter By Pass.....	C-5718
Oil Filter Full Flow.....	C-5701
Oil Filter Full Flow.....	C-5715
<i>(ENGINES)</i>	
CUMMINS KTA50-G2	
Coolant Filter.....	WC-5703
Coolant Filter.....	WC-5711
Coolant Filter.....	WC-5712
Fuel/Water Separator.....	SFC-5601-02
Oil Filter By Pass.....	C-5718
Oil Filter Full Flow.....	C-5701
Oil Filter Full Flow.....	C-5715
<i>(ENGINES)</i>	
CUMMINS KTA50-G3 (S/N: 1250KVA-UP)	
Air Filter Secondary.....	A-7902
Fuel Filter.....	F-5701
Oil Filter Full Flow.....	O-5702
<i>(ENGINES)</i>	
CUMMINS KTA50-G4	
Coolant Filter.....	WC-5711
Fuel Filter.....	FC-5703
Fuel/Water Separator.....	SFC-5601-02
Fuel/Water Separator.....	SFC-5707
Oil Filter By Pass.....	C-5718
Oil Filter Full Flow.....	C-5701
Oil Filter Full Flow.....	C-5715
<i>(ENGINES)</i>	
CUMMINS KTA50-G6	

MODEL/APPLICATION	SAKURA NO
CUMMINS	
<i>(ENGINES)</i> CUMMINS KTA50-G6	
Coolant Filter.....	WC-5703
Coolant Filter.....	WC-5711
Coolant Filter.....	WC-5712
Fuel/Water Separator.....	SFC-5601-02
Oil Filter By Pass.....	C-5718
Oil Filter Full Flow.....	C-5701
Oil Filter Full Flow.....	C-5715
<i>(ENGINES)</i> CUMMINS KTA50-G7	
Coolant Filter.....	WC-5703
Coolant Filter.....	WC-5711
Coolant Filter.....	WC-5712
Fuel/Water Separator.....	SFC-5601-02
Oil Filter By Pass.....	C-5718
Oil Filter Full Flow.....	C-5701
Oil Filter Full Flow.....	C-5715
<i>(ENGINES)</i> CUMMINS KTA50-G8	
Coolant Filter.....	WC-5703
Coolant Filter.....	WC-5711
Coolant Filter.....	WC-5712
Fuel/Water Separator.....	SFC-5601-02
Oil Filter By Pass.....	C-5718
Oil Filter Full Flow.....	C-5701
Oil Filter Full Flow.....	C-5715
<i>(ENGINES)</i> CUMMINS KTA50-G9	
Coolant Filter.....	WC-5703
Coolant Filter.....	WC-5711
Coolant Filter.....	WC-5712
Fuel/Water Separator.....	SFC-5601-02
Oil Filter By Pass.....	C-5718
Oil Filter Full Flow.....	C-5701
Oil Filter Full Flow.....	C-5715
<i>(ENGINES)</i> CUMMINS KTC-450	
Coolant Filter.....	WC-5705
Fuel Filter.....	FC-5720
Fuel/Water Separator.....	SFC-5705
Oil Filter By Pass.....	C-5718
Oil Filter Full Flow.....	C-5715
<i>(ENGINES)</i> CUMMINS KTTA-19-G2	
Coolant Filter.....	WC-5705
Fuel Filter.....	FC-5702
Fuel/Water Separator.....	SFC-5705
Oil Filter By Pass.....	C-5718
Oil Filter Full Flow.....	C-5715
<i>(ENGINES)</i> CUMMINS KTTA-50-G2	
Coolant Filter.....	WC-5711
Fuel Filter.....	FC-5703
Fuel/Water Separator.....	SFC-5601-02
Fuel/Water Separator.....	SFC-5707
Oil Filter By Pass.....	C-5718
Oil Filter Full Flow.....	C-5701

MODEL/APPLICATION	SAKURA NO
CUMMINS	
Oil Filter Full Flow.....	C-5715
<i>(ENGINES)</i> CUMMINS KV38	
Oil Filter By Pass.....	C-5718
Oil Filter Full Flow.....	C-5715
<i>(ENGINES)</i> CUMMINS M11-C (S/N: TIER 1-UP)	
Fuel Filter.....	FC-5720
Oil Filter Combination.....	C-5707
<i>(ENGINES)</i> CUMMINS MEDIUM VEE V-903	
Coolant Filter.....	WC-5705
Fuel Filter.....	FC-5702
Fuel Filter.....	FC-5720
Fuel/Water Separator.....	SFC-5705
Fuel/Water Separator Secondary...	SFC-1905-10
Oil Filter By Pass.....	C-5718
Oil Filter Full Flow.....	C-5715
Oil Filter Full Flow.....	0-5702
<i>(ENGINES)</i> CUMMINS N14 (S/N: PLUS-UP)	
Coolant Filter.....	WC-5705
Coolant Filter.....	WC-5711
Fuel/Water Separator.....	SFC-5709-10
Oil Filter Combination.....	C-5707
Oil Filter Combination.....	C-5723
<i>(ENGINES)</i> CUMMINS N14-G1	
Coolant Filter.....	WC-5703
Coolant Filter.....	WC-5705
Fuel/Water Separator.....	SFC-5701-10
Fuel/Water Separator.....	SFC-5709-10
Oil Filter Combination.....	C-5707
Oil Filter Combination.....	C-5723
<i>(ENGINES)</i> CUMMINS N14-G2	
Coolant Filter.....	WC-5703
Coolant Filter.....	WC-5705
Fuel/Water Separator.....	SFC-5701-10
Fuel/Water Separator.....	SFC-5709-10
Oil Filter Combination.....	C-5707
Oil Filter Combination.....	C-5723
<i>(ENGINES)</i> CUMMINS NH230	
Coolant Filter.....	WC-5705
Fuel Filter.....	FC-5720
Fuel/Water Separator.....	SFC-5705
Fuel/Water Separator Secondary...	SFC-1905-10
Oil Filter By Pass.....	C-5718
Oil Filter Full Flow.....	C-5715
Oil Filter Full Flow.....	0-5702
<i>(ENGINES)</i> CUMMINS NH855	
Coolant Filter.....	WC-5705
Fuel Filter.....	FC-5720
Fuel/Water Separator.....	SFC-5705
Fuel/Water Separator Secondary...	SFC-1905-10
Oil Filter By Pass.....	C-5718

MODEL/APPLICATION	SAKURA NO
CUMMINS	
Oil Filter Full Flow.....	C-5715
Oil Filter Full Flow.....	0-5702
<i>(ENGINES)</i> CUMMINS NT BIG CAM IV SERIES	
Coolant Filter.....	WC-5705
Coolant Filter.....	WC-5712
Fuel Filter.....	FC-5720
Fuel/Water Separator Secondary...	SFC-1905-10
Oil Filter By Pass.....	C-5718
Oil Filter Combination.....	C-5723
Oil Filter Full Flow.....	C-5715
<i>(ENGINES)</i> CUMMINS NT855-G4	
Coolant Filter.....	WC-5703
Coolant Filter.....	WC-5705
Fuel Filter.....	FC-5702
Fuel/Water Separator.....	SFC-5701-10
Fuel/Water Separator.....	SFC-5705
Fuel/Water Separator.....	SFC-5709-10
Fuel/Water Separator Secondary...	SFC-1905-10
Oil Filter By Pass.....	C-5718
Oil Filter Combination.....	C-5707
Oil Filter Combination.....	C-5723
Oil Filter Full Flow.....	C-5715
Oil Filter Full Flow.....	0-5702
<i>(ENGINES)</i> CUMMINS NT855-G5	
Coolant Filter.....	WC-5703
Coolant Filter.....	WC-5705
Fuel Filter.....	FC-5702
Fuel/Water Separator.....	SFC-5701-10
Fuel/Water Separator.....	SFC-5705
Fuel/Water Separator.....	SFC-5709-10
Fuel/Water Separator Secondary...	SFC-1905-10
Oil Filter By Pass.....	C-5718
Oil Filter Combination.....	C-5707
Oil Filter Combination.....	C-5723
Oil Filter Full Flow.....	C-5715
Oil Filter Full Flow.....	0-5702
<i>(ENGINES)</i> CUMMINS NT855-G6	
Coolant Filter.....	WC-5703
Coolant Filter.....	WC-5705
Fuel Filter.....	FC-5702
Fuel/Water Separator.....	SFC-5701-10
Fuel/Water Separator.....	SFC-5705
Fuel/Water Separator.....	SFC-5709-10
Fuel/Water Separator Secondary...	SFC-1905-10
Oil Filter By Pass.....	C-5718
Oil Filter Combination.....	C-5707
Oil Filter Combination.....	C-5723
Oil Filter Full Flow.....	C-5715
Oil Filter Full Flow.....	0-5702
<i>(ENGINES)</i> CUMMINS NTA-855C-420	
Coolant Filter.....	WC-5711
Fuel Filter.....	F-5601
Oil Filter Full Flow.....	0-5603

MODEL/APPLICATION	SAKURA NO
CUMMINS	
<i>(ENGINES)</i> CUMMINS NTA855-G2	
Coolant Filter.....	WC-5703
Coolant Filter.....	WC-5705
Fuel Filter.....	FC-5702
Fuel/Water Separator.....	SFC-5701-10
Fuel/Water Separator.....	SFC-5705
Fuel/Water Separator.....	SFC-5709-10
Fuel/Water Separator Secondary...	SFC-1905-10
Oil Filter By Pass.....	C-5718
Oil Filter Combination.....	C-5707
Oil Filter Combination.....	C-5723
Oil Filter Full Flow.....	C-5715
Oil Filter Full Flow.....	0-5702
<i>(ENGINES)</i> CUMMINS NTA855-G3	
Coolant Filter.....	WC-5703
Coolant Filter.....	WC-5705
Fuel Filter.....	FC-5702
Fuel/Water Separator.....	SFC-5701-10
Fuel/Water Separator.....	SFC-5705
Fuel/Water Separator.....	SFC-5709-10
Fuel/Water Separator Secondary...	SFC-1905-10
Oil Filter By Pass.....	C-5718
Oil Filter Combination.....	C-5707
Oil Filter Combination.....	C-5723
Oil Filter Full Flow.....	C-5715
Oil Filter Full Flow.....	0-5702
<i>(ENGINES)</i> CUMMINS NTA855-G4	
Coolant Filter.....	WC-5703
Coolant Filter.....	WC-5705
Fuel Filter.....	FC-5702
Fuel/Water Separator.....	SFC-5701-10
Fuel/Water Separator.....	SFC-5705
Fuel/Water Separator.....	SFC-5709-10
Fuel/Water Separator Secondary...	SFC-1905-10
Oil Filter By Pass.....	C-5718
Oil Filter Combination.....	C-5707
Oil Filter Combination.....	C-5723
Oil Filter Full Flow.....	C-5715
Oil Filter Full Flow.....	0-5702
<i>(ENGINES)</i> CUMMINS NTA855-G5	
Coolant Filter.....	WC-5703
Coolant Filter.....	WC-5705
Fuel Filter.....	FC-5702
Fuel/Water Separator.....	SFC-5701-10
Fuel/Water Separator.....	SFC-5705
Fuel/Water Separator.....	SFC-5709-10
Fuel/Water Separator Secondary...	SFC-1905-10
Oil Filter By Pass.....	C-5718
Oil Filter Combination.....	C-5707
Oil Filter Combination.....	C-5723
Oil Filter Full Flow.....	C-5715
Oil Filter Full Flow.....	0-5702
<i>(ENGINES)</i> CUMMINS NTA855-G6	
Coolant Filter.....	WC-5703

MODEL/APPLICATION	SAKURA NO
CUMMINS	
Coolant Filter.....	WC-5705
Fuel Filter.....	FC-5702
Fuel/Water Separator.....	SFC-5701-10
Fuel/Water Separator.....	SFC-5705
Fuel/Water Separator.....	SFC-5709-10
Fuel/Water Separator Secondary...	SFC-1905-10
Oil Filter By Pass.....	C-5718
Oil Filter Combination.....	C-5707
Oil Filter Combination.....	C-5723
Oil Filter Full Flow.....	C-5715
Oil Filter Full Flow.....	0-5702
<i>(ENGINES)</i> CUMMINS NTC SERIES	
Coolant Filter.....	WC-5705
Fuel Filter.....	FC-5720
Fuel/Water Separator Secondary...	SFC-1905-10
Oil Filter By Pass.....	C-5718
Oil Filter Combination.....	C-5723
Oil Filter Full Flow.....	C-5715
Oil Filter Full Flow.....	0-5702
<i>(ENGINES)</i> CUMMINS NTC-495-G (S/N: 125KVA-UP)	
Fuel Filter.....	F-5701
Oil Filter Full Flow.....	0-5702
<i>(ENGINES)</i> CUMMINS NTTC-475	
Coolant Filter.....	WC-5705
Fuel Filter.....	FC-5720
Fuel/Water Separator Secondary...	SFC-1905-10
Oil Filter By Pass.....	C-5718
Oil Filter Full Flow.....	C-5715
Oil Filter Full Flow.....	0-5702
<i>(ENGINES)</i> CUMMINS QSB3.3 (S/N: TIER 3-UP)	
Oil Filter Full Flow.....	C-56191
<i>(ENGINES)</i> CUMMINS QSB3.9 (S/N: TIER 2-UP)	
Fuel Filter.....	FS-5701
Fuel/Water Separator.....	SFC-55200
Oil Filter Full Flow.....	C-5708
<i>(ENGINES)</i> CUMMINS QSB4 (S/N: TIER 3-UP)	
Fuel Filter.....	FC-45010
Fuel/Water Separator.....	SFC-5711
Oil Filter Full Flow.....	C-5708
<i>(ENGINES)</i> CUMMINS QSB4.5 (S/N: TIER 2-UP)	
Fuel Filter.....	FS-5701
Fuel/Water Separator.....	SFC-55200
<i>(ENGINES)</i> CUMMINS QSB5.9T (S/N: TIER 2-UP)	
Fuel Filter.....	FC-45010
Fuel Filter.....	FS-5701
Fuel/Water Separator.....	SFC-55200
Oil Filter Full Flow.....	C-5714
<i>(ENGINES)</i> CUMMINS QSB5.9TAA (S/N: TIER 2-UP)	

MODEL/APPLICATION	SAKURA NO
CUMMINS	
Fuel Filter.....	FS-5701
Fuel/Water Separator.....	SFC-55200
Oil Filter Full Flow.....	C-5714
<i>(ENGINES)</i> CUMMINS QSB6 (S/N: TIER 3-UP)	
Fuel Filter.....	FC-45010
Fuel/Water Separator.....	SFC-5711
Oil Filter Full Flow.....	C-5708
Oil Filter Full Flow.....	C-5713
Oil Filter Full Flow.....	C-5734
<i>(ENGINES)</i> CUMMINS QSB6.7 (S/N: TIER 4-UP)	
Oil Filter Full Flow.....	C-5708
Oil Filter Full Flow.....	C-5713
Oil Filter Full Flow.....	C-5734
<i>(ENGINES)</i> CUMMINS QSC (S/N: TIER 3-UP)	
Fuel/Water Separator.....	SFC-5509-10
Fuel/Water Separator.....	SFC-5711
Oil Filter Combination.....	C-5707
<i>(ENGINES)</i> CUMMINS QSC-C (S/N: TIER 4-UP)	
Fuel/Water Separator.....	SFC-5711
Oil Filter Combination.....	C-5707
<i>(ENGINES)</i> CUMMINS QSK19 (S/N: TIER 2-UP)	
Coolant Filter.....	WC-5703
Coolant Filter.....	WC-5705
Oil Filter By Pass.....	C-5718
Oil Filter Combination.....	C-5723
<i>(ENGINES)</i> CUMMINS QSK19 (S/N: TIER 3-UP)	
Coolant Filter.....	WC-5703
Fuel Filter.....	FC-57290
<i>(ENGINES)</i> CUMMINS QSK23	
Coolant Filter.....	WC-5712
Fuel/Water Separator.....	SFC-5601-02
<i>(ENGINES)</i> CUMMINS QSK38	
Fuel Filter.....	FC-57290
<i>(ENGINES)</i> CUMMINS QSK45	
Coolant Filter.....	WC-5712
Coolant Filter.....	WC-5713
Fuel/Water Separator.....	SFC-5601-02
<i>(ENGINES)</i> CUMMINS QSK50 (S/N: TIER 2-UP)	
Fuel Filter.....	FC-57290
<i>(ENGINES)</i> CUMMINS QSK50-G3	
Coolant Filter.....	WC-5703
Fuel Filter.....	FC-57290
<i>(ENGINES)</i> CUMMINS QSK50-G4	
Coolant Filter.....	WC-5703

Sakura Filter

ENGINE APPLICATION

MODEL/APPLICATION	SAKURA NO	MODEL/APPLICATION	SAKURA NO	MODEL/APPLICATION	SAKURA NO
CUMMINS		CUMMINS		CUMMINS	
(ENGINES) CUMMINS QSK50-G4 Fuel Filter..... FC-57290		Fuel/Water Separator..... SFC-5601-02		Fuel Filter..... FC-5703	
(ENGINES) CUMMINS QSK50-G8 Coolant Filter..... WC-5703 Fuel Filter..... FC-57290		(ENGINES) CUMMINS QSK78-G Fuel/Water Separator..... SFC-5601-02		Oil Filter By Pass..... C-5718 Oil Filter Full Flow..... C-5715	
(ENGINES) CUMMINS QSK50-G9 Coolant Filter..... WC-5703 Fuel Filter..... FC-57290		(ENGINES) CUMMINS QSL (S/N: TIER 3-UP) Fuel/Water Separator..... SFC-5509-10 Fuel/Water Separator..... SFC-5711 Oil Filter Combination..... C-5707		(ENGINES) CUMMINS QST30-G3 Fuel Filter..... FC-5703 Oil Filter By Pass..... C-5718 Oil Filter Full Flow..... C-5715	
(ENGINES) CUMMINS QSK60 (S/N: TIER 1-UP) Coolant Filter..... WC-5712 Coolant Filter..... WC-5713 Fuel/Water Separator..... SFC-5601-02		(ENGINES) CUMMINS QSL-C (S/N: TIER 4-UP) Fuel/Water Separator..... SFC-5711 Oil Filter Combination..... C-5707		(ENGINES) CUMMINS QST30-G4 Fuel Filter..... FC-5703 Oil Filter By Pass..... C-5718 Oil Filter Full Flow..... C-5715	
(ENGINES) CUMMINS QSK60 (S/N: TIER 2-UP) Coolant Filter..... WC-5705 Fuel Filter..... FC-57290		(ENGINES) CUMMINS QSM10.8 Coolant Filter..... WC-5705 Fuel/Water Separator..... SFC-5509-10		(ENGINES) CUMMINS QST30-G5 Fuel Filter..... FC-5703 Oil Filter By Pass..... C-5718 Oil Filter Full Flow..... C-5715	
(ENGINES) CUMMINS QSK60-G2 (S/N: TIER 1-UP) Fuel/Water Separator..... SFC-5601-02 Oil Filter Full Flow..... C-5701		(ENGINES) CUMMINS QSM11 (S/N: TIER 2-UP) Fuel/Water Separator..... SFC-5509-10 Fuel/Water Separator..... SFC-5709-10		(ENGINES) CUMMINS QST30-G6 Fuel Filter..... FC-5703 Oil Filter By Pass..... C-5718 Oil Filter Full Flow..... C-5715	
(ENGINES) CUMMINS QSK60-G3 (S/N: TIER 1-UP) Fuel/Water Separator..... SFC-5601-02 Oil Filter Full Flow..... C-5701		(ENGINES) CUMMINS QSM11 (S/N: TIER 3-UP) Coolant Filter..... WC-5703 Coolant Filter..... WC-5705 Coolant Filter..... WC-5712 Coolant Filter..... WC-57170 Fuel/Water Separator..... SFC-5709-10		(ENGINES) CUMMINS QST30-G7 Fuel Filter..... FC-5703 Oil Filter By Pass..... C-5718 Oil Filter Full Flow..... C-5715	
(ENGINES) CUMMINS QSK60-G4 (S/N: TIER 1-UP) Fuel/Water Separator..... SFC-5601-02 Oil Filter Full Flow..... C-5701		(ENGINES) CUMMINS QSM11-G1 (S/N: TIER 1-UP) Coolant Filter..... WC-5712 Fuel/Water Separator..... SFC-5709-10		(ENGINES) CUMMINS QST30-G8 Fuel Filter..... FC-5703 Oil Filter By Pass..... C-5718 Oil Filter Full Flow..... C-5715	
(ENGINES) CUMMINS QSK60-G5 (S/N: TIER 2-UP) Coolant Filter..... WC-5712 Fuel Filter..... FC-57290		(ENGINES) CUMMINS QSM11-G2 (S/N: TIER 1-UP) Coolant Filter..... WC-5712 Fuel/Water Separator..... SFC-5709-10		(ENGINES) CUMMINS QSX15 (S/N: TIER 2-UP) Fuel/Water Separator..... SFC-5521	
(ENGINES) CUMMINS QSK60-G6 (S/N: TIER 2-UP) Coolant Filter..... WC-5712 Fuel Filter..... FC-57290		(ENGINES) CUMMINS QSM11-G3 (S/N: TIER 3-UP) Coolant Filter..... WC-5712 Fuel/Water Separator..... SFC-5509-10		(ENGINES) CUMMINS QSX15-C (S/N: TIER 3-UP) Coolant Filter..... WC-57010 Coolant Filter..... WC-57020	
(ENGINES) CUMMINS QSK60-G7 (S/N: TIER 2-UP) Coolant Filter..... WC-5712 Fuel Filter..... FC-57290		(ENGINES) CUMMINS QSM11-G4 (S/N: TIER 3-UP) Coolant Filter..... WC-5712 Fuel/Water Separator..... SFC-5509-10		(ENGINES) CUMMINS SIGNATURE 600 Coolant Filter..... WC-57010 Coolant Filter..... WC-57020 Fuel/Water Separator..... SFC-5521	
(ENGINES) CUMMINS QSK60-GS2 (S/N: TIER 1-UP) Fuel/Water Separator..... SFC-5601-02 Oil Filter Full Flow..... C-5701		(ENGINES) CUMMINS QST30 Coolant Filter..... WC-5712 Fuel Filter..... FC-5714 Fuel/Water Separator..... SFC-5601-02		(ENGINES) CUMMINS SMALL VEE SERIES Coolant Filter..... WC-5705 Fuel Filter..... FC-5720 Fuel/Water Separator Secondary... SFC-1905-10 Oil Filter By Pass..... C-5718 Oil Filter By Pass..... O-5705 Oil Filter Full Flow..... O-5703	
(ENGINES) CUMMINS QSK60-GS3 (S/N: TIER 1-UP) Fuel/Water Separator..... SFC-5601-02 Oil Filter Full Flow..... C-5701		(ENGINES) CUMMINS QST30-G1 Fuel Filter..... FC-5703 Oil Filter By Pass..... C-5718 Oil Filter Full Flow..... C-5715		(ENGINES) CUMMINS SMALL VEE SERIES V-555 Coolant Filter..... WC-5705	
(ENGINES) CUMMINS QSK78 Coolant Filter..... WC-5703		(ENGINES) CUMMINS QST30-G2			

Sakura Filter

ENGINE APPLICATION

MODEL/APPLICATION	SAKURA NO	MODEL/APPLICATION	SAKURA NO	MODEL/APPLICATION	SAKURA NO
CUMMINS		CUMMINS		CUMMINS	
<i>(ENGINES)</i> CUMMINS SMALL VEE SERIES V-555		<i>(ENGINES)</i> CUMMINS VTA28-G1		<i>(MARINE)</i> CMD QSL9	
Fuel Filter.....	FC-5720	Coolant Filter.....	WC-5711	Fuel Filter.....	FC-5713
Fuel/Water Separator Secondary..	SFC-1905-10	Fuel Filter.....	FC-5703	<i>(MARINE)</i> CMD QSM11	Fuel Filter.....
Oil Filter By Pass.....	C-5718	Fuel/Water Separator.....	SFC-5707	Fuel Filter.....	FC-5713
Oil Filter By Pass.....	0-5705	Oil Filter By Pass.....	C-5718	<i>(MARINE)</i> CUMMINS 6C8.3	Coolant Filter.....
Oil Filter Full Flow.....	0-5702	Oil Filter Full Flow.....	C-5715	Fuel Filter Secondary.....	FC-7903
<i>(ENGINES)</i> CUMMINS V28G5		<i>(ENGINES)</i> CUMMINS VTA28-G2		Fuel/Water Separator.....	SFC-5708
Coolant Filter.....	WC-5703	Coolant Filter.....	WC-5711	Oil Filter Combination.....	C-5706
Fuel Filter.....	FC-5703	Fuel Filter.....	FC-5703	Oil Filter Combination.....	C-5723
Oil Filter Full Flow.....	C-5715	Fuel/Water Separator.....	SFC-5707	<i>(MARINE)</i> CUMMINS 6CT8.3	
<i>(ENGINES)</i> CUMMINS V6-150		<i>(ENGINES)</i> CUMMINS VTA28-G3		Coolant Filter.....	WC-5705
Coolant Filter.....	WC-5705	Coolant Filter.....	WC-5711	Fuel Filter Secondary.....	FC-7903
Fuel Filter.....	FC-5720	Fuel Filter.....	FC-5703	Fuel/Water Separator.....	SFC-5708
Fuel/Water Separator Secondary..	SFC-1905-10	Fuel/Water Separator.....	SFC-5707	Oil Filter Combination.....	C-5706
Oil Filter By Pass.....	C-5718	Oil Filter By Pass.....	C-5718	Oil Filter Combination.....	C-5723
Oil Filter By Pass.....	0-5705	Oil Filter Full Flow.....	C-5715	<i>(MARINE)</i> CUMMINS 3A1.7	
Oil Filter Full Flow.....	0-5703	<i>(ENGINES)</i> CUMMINS VTA28-G5		Air Filter Primary.....	AS-1014
<i>(ENGINES)</i> CUMMINS V8-210		<i>(ENGINES)</i> CUMMINS VTA28-G5		Air Filter Set.....	AS-1014-S
Coolant Filter.....	WC-5705	Coolant Filter.....	WC-5711	<i>(MARINE)</i> CUMMINS 4A2.3	
Fuel Filter.....	FC-5720	Fuel Filter.....	FC-5703	Air Filter Primary.....	AS-1014
Fuel/Water Separator Secondary..	SFC-1905-10	Fuel/Water Separator.....	SFC-5707	Air Filter Primary.....	AS-6905
Oil Filter By Pass.....	C-5718	Oil Filter By Pass.....	C-5718	Air Filter Set.....	AS-1014-S
Oil Filter By Pass.....	0-5705	Oil Filter Full Flow.....	C-5715	Air Filter Set.....	AS-6905-S
Oil Filter Full Flow.....	0-5703	<i>(ENGINES)</i> CUMMINS VTA-903		<i>(MARINE)</i> CUMMINS 6CTA8.3M1	
<i>(ENGINES)</i> CUMMINS VT-225		<i>(ENGINES)</i> CUMMINS VTA-903		Coolant Filter.....	WC-5705
Coolant Filter.....	WC-5705	Coolant Filter.....	WC-5705	Fuel Filter Secondary.....	FC-7903
Fuel Filter.....	FC-5720	Fuel Filter.....	FC-5702	Fuel/Water Separator.....	SFC-5708
Fuel/Water Separator Secondary..	SFC-1905-10	Fuel/Water Separator.....	SFC-5705	Oil Filter Combination.....	C-5706
Oil Filter By Pass.....	C-5718	Fuel/Water Separator Secondary..	SFC-1905-10	Oil Filter Combination.....	C-5723
Oil Filter By Pass.....	0-5705	Oil Filter By Pass.....	C-5718	<i>(MARINE)</i> CUMMINS 6CTA8.M1	
Oil Filter Full Flow.....	0-5702	Oil Filter Full Flow.....	C-5715	Fuel/Water Separator.....	SFC-5708
<i>(ENGINES)</i> CUMMINS VT-228		<i>(ENGINES)</i> CUMMINS VTA-903		<i>(MARINE)</i> CUMMINS KT-1150M	
Coolant Filter.....	WC-5711	Coolant Filter.....	WC-5705	Coolant Filter.....	WC-5705
Fuel Filter.....	FC-5703	Fuel Filter.....	FC-5702	Fuel Filter.....	FC-5702
Fuel/Water Separator.....	SFC-5707	Oil Filter By Pass.....	C-5718	Fuel Filter.....	FC-5721
Oil Filter By Pass.....	C-5718	Oil Filter Full Flow.....	C-5715	<i>(MARINE)</i> CUMMINS KT-19-M	
Oil Filter Full Flow.....	C-5715	<i>(ENGINES)</i> CUMMINS NTC-365		Coolant Filter.....	WC-5703
<i>(ENGINES)</i> CUMMINS VT-350		<i>(ENGINES)</i> CUMMINS NTC-365		Coolant Filter.....	WC-5705
Coolant Filter.....	WC-5705	Fuel Filter.....	FC-5721	Fuel Filter.....	FC-5702
Fuel Filter.....	FC-5702	<i>(ENGINES)</i> CUMMINS NTC-444		Fuel Filter.....	FC-5721
Fuel Filter.....	FC-5720	Fuel Filter.....	FC-5721	<i>(MARINE)</i> CMD QSB5.9 ES	
Fuel/Water Separator.....	SFC-5705	<i>(MARINE)</i> CMD QSB5.9-M		Fuel Filter.....	FC-5713
Fuel/Water Separator Secondary..	SFC-1905-10	<i>(MARINE)</i> CMD QSB5.9-M		Fuel Filter.....	FC-5713
Oil Filter By Pass.....	C-5718	<i>(MARINE)</i> CMD QSB5.9-M		Fuel Filter.....	FC-5713
Oil Filter Full Flow.....	C-5715	<i>(MARINE)</i> CMD QSB5.9-M		Fuel Filter.....	FC-5713
Oil Filter Full Flow.....	0-5702	<i>(MARINE)</i> CMD QSB5.9-M		Fuel Filter.....	FC-5713
<i>(ENGINES)</i> CUMMINS VTA28		<i>(MARINE)</i> CMD QSB5.9-M		<i>(MARINE)</i> CUMMINS KT-2300M	
Coolant Filter.....	WC-5703	Fuel Filter.....	FC-5713	Coolant Filter.....	WC-5711
Fuel/Water Separator.....	SFC-5601-02	<i>(MARINE)</i> CMD QSC8.3		<i>(MARINE)</i> CUMMINS KT-2300M	
Oil Filter By Pass.....	C-5718	Fuel Filter.....	FC-5713	Coolant Filter.....	WC-5711

Sakura Filter

ENGINE APPLICATION

MODEL/APPLICATION	SAKURA NO	MODEL/APPLICATION	SAKURA NO	MODEL/APPLICATION	SAKURA NO
CUMMINS		CUMMINS		CUMMINS	
(MARINE) CUMMINS KT-2300M Fuel/Water Separator.....	SFC-5707	(MARINE) CUMMINS NTA-855M Coolant Filter.....	WC-5703	Coolant Filter.....	WC-5705
(MARINE) CUMMINS KT-38-M Coolant Filter.....	WC-5711	Coolant Filter.....	WC-5705	Fuel Filter.....	FC-5702
Fuel/Water Separator.....	SFC-5707	Fuel Filter.....	FC-5721	Fuel Filter.....	FC-5721
(MARINE) CUMMINS KTA 19-M Coolant Filter.....	WC-5703	Fuel Filter.....	FC-5721	(MARINE) CUMMINS N14-M Coolant Filter.....	WC-5703
Fuel Filter.....	FC-5702	Fuel/Water Separator.....	SFC-5705	Coolant Filter.....	WC-5705
Oil Filter By Pass.....	C-5718	Oil Filter By Pass.....	C-5718	Coolant Filter.....	WC-5711
Oil Filter Full Flow.....	C-5715	Oil Filter Combination.....	C-5706	Fuel Filter.....	FC-5702
(MARINE) CUMMINS KTA-1150M Coolant Filter.....	WC-5705	Oil Filter Combination.....	C-5723	Fuel/Water Separator.....	SFC-5701-10
Fuel Filter.....	FC-5702	Oil Filter Full Flow.....	C-5715	Fuel/Water Separator.....	SFC-5709-10
Fuel Filter.....	FC-5721	(MARINE) CUMMINS V-504M Coolant Filter.....	WC-5705	Oil Filter Combination.....	C-5707
(MARINE) CUMMINS KTA-19-M Coolant Filter.....	WC-5705	Fuel Filter.....	FC-5702	Oil Filter Combination.....	C-5723
Fuel Filter.....	FC-5702	Fuel Filter.....	FC-5721	(MARINE) CUMMINS 4B3.9-M Fuel Filter Secondary.....	FC-7903
Fuel Filter.....	FC-5721	Fuel/Water Separator.....	SFC-5705	Fuel/Water Separator.....	SFC-5706
(MARINE) CUMMINS KTA-2300M Fuel/Water Separator.....	SFC-5707	Oil Filter By Pass.....	0-5705	Fuel/Water Separator.....	SFC-5708
(MARINE) CUMMINS KTA-3067M Fuel/Water Separator.....	SFC-5707	(MARINE) CUMMINS V-555M Coolant Filter.....	WC-5705	Oil Filter Full Flow.....	C-5703
(MARINE) CUMMINS KTA38-M Coolant Filter.....	WC-5711	Fuel Filter.....	FC-5702	(MARINE) CUMMINS 4BTA3.9-M Fuel Filter Secondary.....	FC-7903
Fuel Filter.....	FC-5703	Fuel Filter.....	FC-5721	Fuel/Water Separator.....	SFC-5706
Fuel/Water Separator.....	SFC-5707	Fuel/Water Separator.....	SFC-5705	Fuel/Water Separator.....	SFC-5708
Oil Filter By Pass.....	C-5718	Oil Filter By Pass.....	0-5705	Oil Filter Full Flow.....	C-5703
Oil Filter Full Flow.....	C-5715	(MARINE) CUMMINS V-903M Coolant Filter.....	WC-5705	(MARINE) CUMMINS 6B5.9-M Fuel Filter Secondary.....	FC-7903
(MARINE) CUMMINS KTA-50-M Coolant Filter.....	WC-5703	Fuel Filter.....	FC-5702	Fuel/Water Separator.....	SFC-5706
Coolant Filter.....	WC-5711	Fuel Filter.....	FC-5721	Fuel/Water Separator.....	SFC-5708
Fuel Filter.....	FC-5703	(MARINE) CUMMINS VT-1710M Coolant Filter.....	WC-5711	Fuel/Water Separator.....	SFC-7924
Fuel/Water Separator.....	SFC-5707	(MARINE) CUMMINS VT-555M Fuel Filter.....	FC-5702	Oil Filter Full Flow.....	C-5704
Oil Filter By Pass.....	C-5718	Fuel Filter.....	FC-5721	(MARINE) CUMMINS 6BT5.9-M Fuel Filter Secondary.....	FC-7903
Oil Filter Full Flow.....	C-5701	Oil Filter By Pass.....	0-5705	Fuel/Water Separator.....	SFC-5706
Oil Filter Full Flow.....	C-5715	(MARINE) CUMMINS VT-903M Fuel Filter.....	FC-5702	Fuel/Water Separator.....	SFC-5708
(MARINE) CUMMINS N-855M Coolant Filter.....	WC-5705	Fuel Filter.....	FC-5721	Fuel/Water Separator.....	SFC-7924
Fuel Filter.....	FC-5702	(MARINE) CUMMINS VTA-1710M Coolant Filter.....	WC-5711	Oil Filter Full Flow.....	C-5704
Fuel Filter.....	FC-5721	(MARINE) CUMMINS VTA-28-M Coolant Filter.....	WC-5711	(MARINE) CUMMINS 6BTA5.9-M Fuel Filter Secondary.....	FC-7903
Fuel/Water Separator.....	SFC-5705	Fuel Filter.....	FC-5703	Fuel/Water Separator.....	SFC-5706
Oil Filter Combination.....	C-5706	Oil Filter By Pass.....	C-5718	Fuel/Water Separator.....	SFC-5708
Oil Filter Combination.....	C-5723	Oil Filter Full Flow.....	C-5715	Oil Filter Full Flow.....	C-5704
(MARINE) CUMMINS NT-903M Coolant Filter.....	WC-5705	(MARINE) CUMMINS VTA-903M Coolant Filter.....	WC-5711	(MARINE) CUMMINS 6C8.3-M Coolant Filter.....	WC-5705
				Fuel Filter Secondary.....	FC-7903
				Fuel/Water Separator.....	SFC-5706
				Fuel/Water Separator.....	SFC-5708
				Fuel/Water Separator.....	SFC-7924
				Oil Filter Full Flow.....	C-5704
				(MARINE) CUMMINS 6C8.3-M Coolant Filter.....	WC-5705
				Fuel Filter Secondary.....	FC-7903
				Fuel/Water Separator.....	SFC-5708
				Fuel/Water Separator.....	SFC-5708
				Oil Filter Combination.....	C-5723

MODEL/APPLICATION	SAKURA NO
CUMMINS	
<i>(MARINE)</i> CUMMINS 6CT8.3-M	
Coolant Filter.....	WC-5705
Fuel Filter Secondary.....	FC-7903
Fuel/Water Separator.....	SFC-5708
Oil Filter Combination.....	C-5723
<i>(MARINE)</i> CUMMINS 6CTA8.3-M	
Coolant Filter.....	WC-5705
Fuel Filter Secondary.....	FC-7903
Fuel/Water Separator.....	SFC-5708
Oil Filter Combination.....	C-5723
<i>(MARINE)</i> CUMMINS KTA19-M3	
Coolant Filter.....	WC-5703
Fuel Filter.....	FC-5702
Oil Filter By Pass.....	C-5718
Oil Filter Full Flow.....	C-5715
<i>(MARINE)</i> CUMMINS KTA19-M4	
Coolant Filter.....	WC-5703
Fuel Filter.....	FC-5702
Oil Filter By Pass.....	C-5718
Oil Filter Full Flow.....	C-5715
<i>(MARINE)</i> CUMMINS KTA38-M1	
Coolant Filter.....	WC-5711
Fuel Filter.....	FC-5703
Fuel/Water Separator.....	SFC-5707
Oil Filter By Pass.....	C-5718
Oil Filter Full Flow.....	C-5715
<i>(MARINE)</i> CUMMINS KTA38-M2	
Coolant Filter.....	WC-5711
Fuel Filter.....	FC-5703
Fuel/Water Separator.....	SFC-5707
Oil Filter By Pass.....	C-5718
Oil Filter Full Flow.....	C-5715
<i>(MARINE)</i> CUMMINS KTA50-M1	
Coolant Filter.....	WC-5703
Fuel Filter.....	FC-5703
Oil Filter By Pass.....	C-5718
Oil Filter Full Flow.....	C-5701
Oil Filter Full Flow.....	C-5715
<i>(MARINE)</i> CUMMINS KTA50-M2	
Coolant Filter.....	WC-5711
Fuel Filter.....	FC-5703
Fuel/Water Separator.....	SFC-5707
Oil Filter By Pass.....	C-5718
Oil Filter Full Flow.....	C-5701
Oil Filter Full Flow.....	C-5715
<i>(MARINE)</i> CUMMINS NT-855M	
Coolant Filter.....	WC-5703
Fuel Filter.....	FC-5702

MODEL/APPLICATION	SAKURA NO
CUMMINS	
Fuel Filter.....	FC-5721
Oil Filter By Pass.....	C-5718
Oil Filter Full Flow.....	C-5715
<i>(MARINE)</i> CUMMINS QSB5.9-M	
Fuel Filter.....	FC-5713
<i>(MARINE)</i> CUMMINS QSC8.3-M	
Coolant Filter.....	WC-5705
Fuel Filter.....	FC-5713
Fuel/Water Separator.....	SFC-5702-10
Oil Filter Combination.....	C-5707
<i>(MARINE)</i> CUMMINS QSK19-M	
Coolant Filter.....	WC-5703
Oil Filter Combination.....	C-5723
<i>(MARINE)</i> CUMMINS QSK19-M (S/N: TIER 2-UP)	
Fuel Filter.....	FC-57290
<i>(MARINE)</i> CUMMINS QSK38-M	
Coolant Filter.....	WC-5712
Fuel Filter.....	FC-57290
<i>(MARINE)</i> CUMMINS QSK38-M (S/N: TIER 2-UP)	
Coolant Filter.....	WC-5712
Fuel Filter.....	FC-57290
<i>(MARINE)</i> CUMMINS QSK50-M (S/N: TIER 2-UP)	
Coolant Filter.....	WC-5712
Fuel Filter.....	FC-57290
<i>(MARINE)</i> CUMMINS QSK60-M	
Coolant Filter.....	WC-5712
<i>(MARINE)</i> CUMMINS QSKTA60-ME (S/N: TIER 2-UP)	
Coolant Filter.....	WC-5712
Fuel Filter.....	FC-57290
<i>(MARINE)</i> CUMMINS QSL9-M	
Coolant Filter.....	WC-5711
Oil Filter Combination.....	C-5707
<i>(MARINE)</i> CUMMINS QSM11-M	
Coolant Filter.....	WC-5712
Tector 4 <i>(ENGINES)</i>	
Fuel Filter.....	FC-56251
Tector 6 <i>(ENGINES)</i>	
Fuel Filter.....	FC-56251



Technical Specification

B

Sakura Filter

Technical Specification

A-44200 Air Filter Metal End Cap Element

CUMMINS 4071693



H 1 : 247.75 (mm)
H 2 : 235 (mm)
OD 1 : 130 (mm)
OD 2 : 130 (mm)
ID 1 : 70 (mm)
ID 2 : 11.5 (mm)

CONT : 16
VOL : 0.082

1

A-5541M-S Air Filter Set Soft PU+Metal Element

CATERPILLAR 131-8902+131-8903



Primary Filter uses A-5541M
Secondary Filter uses A-5540

H 1 : 353 (mm)
H 2 : 344 (mm)
OD 1 : 163.5 (mm)
OD 2 : 163.5 (mm)
ID 1 : 91 (mm)

CONT : 9
VOL : 0.119

6

A-8506 Air Filter Primary Soft PU end cap Element

CASE 222425A1
ISUZU 8-97231900-0
JOHN DEERE KV16428



Secondary Filter uses A-8565

H 1 : 330.8 (mm)
H 2 : 322 (mm)
OD 1 : 138 (mm)
OD 2 : 138 (mm)
ID 1 : 81 (mm)

CONT : 12
VOL : 0.099

11

A-44210 Air Filter Soft PU end cap Element

AIR SUPPLY COMP 193333
NELSON 870904A
NELSON 870904N
NELSON 871148A



H 1 : 525 (mm)
H 2 : 514 (mm)
OD 1 : 280 (mm)
OD 2 : 280 (mm)
ID 1 : 140 (mm)

CONT : 1
VOL : 0.047

2

A-76231 Air Filter Primary Soft PU end cap Element flame retardant media

CLARK 1241080
TOYOTA 17741-U3330-71
KOMATSU 3EC02A541E



H 1 : 356 (mm)
H 2 : 347 (mm)
OD 1 : 163.5 (mm)
OD 2 : 163.5 (mm)
ID 1 : 91 (mm)

CONT : 9
VOL : 0.116

Note : Flame Retardant version of A-5541

7

A-8506-S Air Filter Set Soft PU end cap Element

CASE 222425A1+222429A1
JOHN DEERE KV16428+AP33331



Primary Filter uses A-8506
Secondary Filter uses A-8565

H 1 : 330.8 (mm)
H 2 : 322 (mm)
OD 1 : 138 (mm)
OD 2 : 138 (mm)
ID 1 : 81 (mm)

CONT : 12
VOL : 0.101

12

A-5540 Air Filter Secondary Soft PU end cap Element

YANMAR 119117-12570
CATERPILLAR 1318903
PERKINS 26510343
YANMAR Y119117-12570



Primary Filter uses A-5541
Set Filter uses A-5541-S

H 1 : 346 (mm)
H 2 : 340 (mm)
OD 1 : 92 (mm)
OD 2 : 86.5 (mm)
ID 1 : 72.5 (mm)

CONT : 25
VOL : 0.105

3

A-7902 Air Filter Secondary Metal End Cap Element

HITACHI 4331920
CATERPILLAR 9Y-7663

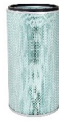

Primary Filter uses A-9217
Set Filter uses A-9217-S

H 1 : 563.35 (mm)
H 2 : 550.6 (mm)
OD 1 : 276 (mm)
OD 2 : 276 (mm)
ID 1 : 207.5 (mm)
ID 2 : 22.7 (mm)

CONT : 1
VOL : 0.048

8

A-87560 Air Filter Metal framed Element

FARR 52711-000
FARR T520DR



H 1 : 132 (mm)
Length 1 : 494 (mm)
Width 1 : 494 (mm)

CONT : 1
VOL : 0.041

13

A-5541 Air Filter Primary Soft PU end cap Element

YANMAR 119117-12560
CATERPILLAR 131-8902
PERKINS 26510342
HITACHI 4486002



Secondary Filter uses A-5540
Set Filter uses A-5541-S

H 1 : 356 (mm)
H 2 : 347 (mm)
OD 1 : 163.5 (mm)
OD 2 : 163.5 (mm)
ID 1 : 91 (mm)

CONT : 9
VOL : 0.108

4

A-8504 Air Filter Primary Soft PU end cap Element

YANMAR 119655-12560
KOMATSU 11965512560
KUBOTA 1G659-11220



Secondary Filter uses A-7618
Set Filter uses A-7620-S

H 1 : 187 (mm)
H 2 : 179 (mm)
OD 1 : 88.5 (mm)
OD 2 : 88.5 (mm)
ID 1 : 46 (mm)

CONT : 25
VOL : 0.054

9

AH-5701 Air Filter Rigid PU end cap Disposable Housing

CUMMINS 3315741



H 1 : 394 (mm)
H 2 : 319 (mm)
Intake Connection Height : 75 (mm)
Outside Housing OD 1 : 428 (mm)
Outside Housing OD 2 : 428 (mm)

CONT : 1
VOL : 0.070

14

A-5541M Air Filter Primary Soft PU+Metal Element

CATERPILLAR 131-8902



Secondary Filter uses A-5540
Set Filter uses A-5541M-S

H 1 : 356 (mm)
H 2 : 347 (mm)
OD 1 : 163.5 (mm)
OD 2 : 163.5 (mm)
ID 1 : 91 (mm)

CONT : 9
VOL : 0.108

5

A-8504S Air Filter Primary Soft PU end cap Element

YANMAR 119655-12560
KOMATSU 11965512560
KUBOTA 1G659-11220



H 1 : 187 (mm)
H 2 : 179 (mm)
OD 1 : 88.5 (mm)
OD 2 : 88.5 (mm)
ID 1 : 46 (mm)

CONT : 25
VOL : 0.054

Note : Flame Retardant version from A-8504

10

AH-5706 Air Filter Rigid PU end cap Disposable Housing

CUMMINS 3924893
CATERPILLAR 3I-2125



H 1 : 278 (mm)
H 2 : 244 (mm)
Intake Connection Height : 34 (mm)
Outside Housing OD 1 : 218 (mm)
Outside Housing OD 2 : 218 (mm)
Intake Connection ID 1 : 75 (mm)

CONT : 9
VOL : 0.160

15

Sakura Filter

Technical Specification

AH-5709 Air Filter Rigid PU end cap Disposable Housing
FARR 96896003



H 1 : 510 (mm)
H 2 : 480 (mm)
Intake Connection Height : 30 (mm)
Outside Housing OD 1 : 255 (mm)
Outside Housing OD 2 : 246 (mm)
Intake Connection ID 1 : 124 (mm)

CONT : 4
VOL : 0.160

16

AS-6905-S Air Filter Set Metal End Cap Element With Sleeve
NEW HOLLAND (CNH) 221409+266222



Primary Filter uses AS-6905
Secondary Filter uses A-7965
H 1 : 392 (mm)
H 2 : 381 (mm)
OD 1 : 160 (mm)
OD 2 : 133.5 (mm)
ID 1 : 82 (mm)
ID 2 : 17 (mm)

CONT : 9
VOL : 0.125

21

C-5708 Oil Filter Full Flow Spin-On
J.C.BAMFORD 32/925413
CUMMINS 3937736



H 1 : 174 (mm)
OD 1 : 93 (mm)
Thread Size : 1 1/8-16 UNF-2B
Gasket Type : Square

CONT : 12
VOL : 0.027

Note : Glass Fiber media uses C-5733

26

AH-5710 Air Filter Rigid PU end cap Disposable Housing
CUMMINS 3924541



H 1 : 303 (mm)
H 2 : 267 (mm)
Intake Connection Height : 36 (mm)
Outside Housing OD 1 : 266 (mm)
Outside Housing OD 2 : 266 (mm)
Intake Connection ID 1 : 101 (mm)

CONT : 4
VOL : 0.105

17

C-56191 Oil Filter Full Flow Spin-On long life
KOMATSU 600-211-2110
CASE 87409203
NEW HOLLAND (CNH) 87415600
CUMMINS C6002112110



H 1 : 86.5 (mm)
OD 1 : 76 (mm)
Thread Size : 3/4-16 UNF-2B
BPV (kg/cm2) : 1.0
ADBV : YES
Gasket Type : Square

CONT : 50
VOL : 0.032

Note : C-56190(bottom plate difference)

22

C-5714 Oil Filter Full Flow Spin-On long life
CUMMINS 3934430
CASE J934430



H 1 : 174 (mm)
OD 1 : 93 (mm)
Thread Size : 1-16 UNF-2B
Gasket Type : Square

CONT : 12
VOL : 0.025

27

AS-1014 Air Filter Primary Metal End Cap Element With Sleeve
ISUZU 1-14215135-0
TOYOTA 1001905
YANMAR 171064-12540



Secondary Filter uses A-7919
Set Filter uses AS-1014-S
H 1 : 288 (mm)
H 2 : 279 (mm)
OD 1 : 160 (mm)
OD 2 : 134 (mm)
ID 1 : 66.5 (mm)
ID 2 : 17 (mm)

CONT : 9
VOL : 0.089

18

C-5701 Oil Filter Full Flow Spin-On
HITACHI 4085913
KOMATSU 600-211-1231



H 1 : 286 (mm)
OD 1 : 118 (mm)
Thread Size : 1 1/2-12 UNF-2B
Gasket Type : Square

CONT : 10
VOL : 0.055

Note : related to:C-5605,C-5731,C-5715(short versions)

23

C-5715 Oil Filter Full Flow Spin-On
CUMMINS 3313279
MITSUBISHI 37540-01101
CUMMINS 3889310
KOMATSU CULF-670



H 1 : 246 (mm)
OD 1 : 118 (mm)
Thread Size : 1 1/2-12 UNF-2B

CONT : 6
VOL : 0.030

Note : Height 286 MM Uses C-5701

28

AS-1014-S Air Filter Set Metal End Cap Element With Sleeve
KUBOTA 1560611080 + 6833543620



Primary Filter uses AS-1014
Secondary Filter uses A-7919
H 1 : 288 (mm)
H 2 : 253 (mm)
OD 1 : 160 (mm)
OD 2 : 134 (mm)
ID 1 : 66.5 (mm)
ID 2 : 17 (mm)

CONT : 9
VOL : 0.092

19

C-5703 Oil Filter Full Flow Spin-On
HYUNDAI 11E1-70110
GENERAL MOTORS 25011995
CUMMINS 3903224
KOMATSU 6732-51-5140
CASE J908616



H 1 : 135 (mm)
OD 1 : 93 (mm)
Thread Size : 1-16 UNF-2B
Gasket Type : Square

CONT : 12
VOL : 0.018

24

C-5718 Oil Filter By Pass Spin-On
ISUZU 1-87310093-0
CATERPILLAR 1W-8845
J.C.BAMFORD 32/919502
HITACHI 4285964



H 1 : 246 (mm)
OD 1 : 115.5 (mm)
Thread Size : 1 3/8-16 UNF-2B

CONT : 6
VOL : 0.029

29

AS-6905 Air Filter Primary Metal End Cap Element With Sleeve
NEW HOLLAND (CNH) 221409
INGERSOLL RAND 35291970
CATERPILLAR 3I-0814
INGERSOLL RAND 51069664



Secondary Filter uses A-7965
Set Filter uses AS-6905-S
H 1 : 392 (mm)
H 2 : 381 (mm)
OD 1 : 160 (mm)
OD 2 : 133.5 (mm)
ID 1 : 82 (mm)
ID 2 : 17 (mm)

CONT : 9
VOL : 0.125

20

C-5706 Oil Filter Combination Spin-On Seamless
CROSLAND 2135
CUMMINS 3318853
HITACHI 4228688



H 1 : 280 (mm)
OD 1 : 121 (mm)
Thread Size : 2 1/4-12 UNF-2B
Gasket Type : Square

CONT : 6
VOL : 0.034

Note : C-5706 Non Multylayer type, C-5721 Multi layer type, C-5722 Multi layer & Seamless type

25

C-5723 Oil Filter Combination Spin-On
KOMATSU 6742-01-4120



H 1 : 280 (mm)
OD 1 : 121 (mm)
Thread Size : 2 1/4-12 UNF-2B
Gasket Type : Square

CONT : 6
VOL : 0.033

30

Sakura Filter

Technical Specification

C-5734 Oil Filter Full Flow Spin-On

CUMMINS 4897898
CASE 87803261



H 1 : 172 (mm)
OD 1 : 93.5 (mm)
Thread Size : M27X2-6H
Gasket Type : Square

CONT : 12
VOL : 0.026

Note : High Performance Grade Uses C-5713

C-57440 Oil Filter Full Flow Spin-On

ONAN 1220550
KOMATSU 1245424H1
KOMATSU 20M6031230
TCM 2265782081
NEW HOLLAND (CNH) 507407



H 1 : 130 (mm)
OD 1 : 93 (mm)
Thread Size : M22X1.5-6H

CONT : 25
VOL : 0.038

F-5601 Fuel Filter Metal End Cap Element

KOMATSU 6610-72-8600



H 1 : 235 (mm)
H 2 : 235 (mm)
OD 1 : 126 (mm)
OD 2 : 126 (mm)
ID 1 : 25 (mm)
ID 2 : 25 (mm)

CONT : 20
VOL : 0.112

Note : Hanger, Paper Protector

C-57390 Oil Filter Combination Spin-On Synthetic Media

CUMMINS 3973686
CASE 87349575



H 1 : 234 (mm)
OD 1 : 118 (mm)
Thread Size : 2 1/4-12 UNF-2B

CONT : 6
VOL : 0.030

C-7927 Oil Filter Combination Spin-On

KOMATSU CULF 3548
CASE J919562



H 1 : 238 (mm)
OD 1 : 121 (mm)
Thread Size : 2 1/4-12 UNF-2B
Gasket Type : Square

CONT : 6
VOL : 0.030

F-5701 Fuel Filter Metal End Cap Element

CUMMINS 139097
CUMMINS 256834



H 1 : 251.2 (mm)
H 2 : 238 (mm)
OD 1 : 147.7 (mm)
OD 2 : 147.7 (mm)
ID 1 : 25 (mm)
ID 2 : 25 (mm)

CONT : 9
VOL : 0.074

Note : Hanger, Paper Protector

C-57400 Oil Filter Full Flow Spin-On

CUMMINS POWER GENERATION
LTD 1220922



H 1 : 147 (mm)
OD 1 : 76 (mm)
Thread Size : 3/4-16 UNF-2B
Gasket Type : Square

CONT : 25
VOL : 0.028

C-8805 Oil Filter Full Flow Spin-On

CARRIER 25-34602-00
MASSEY-FERGUSON 3281019-M1



H 1 : 118 (mm)
OD 1 : 80 (mm)
Thread Size : 3/4-16 UNF-2B
BPV (kg/cm2) : 1.0
ADBV : YES
Gasket Type : Square

CONT : 50
VOL : 0.052

FC-45010 Fuel Filter Spin-On

NEW HOLLAND (CNH) 87803197
CASE 87803200



H 1 : 172 (mm)
OD 1 : 93 (mm)
Thread Size : M20X1.5-6H
Gasket Type : Square

CONT : 12
VOL : 0.027

C-57420 Oil Filter By Pass Spin-On

TATA 252718130132



H 1 : 175 (mm)
OD 1 : 93 (mm)
Thread Size : 1-16 UNF-2B
Gasket Type : Square

CONT : 12
VOL : 0.025

EF-5705-10 Fuel/Water Separator Eco Element

CHRYSLER 05015581AA
CHRYSLER 05015581AB
CUMMINS 3942470
CUMMINS 3945213
CUMMINS 4941251



H 1 : 104 (mm)
H 2 : 101 (mm)
OD 1 : 82.5 (mm)
OD 2 : 85 (mm)
ID 1 : 19 (mm)

CONT : 50
VOL : 0.049

FC-56251 Fuel Filter Spin-On High Efficiency

DAF 1399760
CUMMINS 4897833



H 1 : 174 (mm)
OD 1 : 93 (mm)
Thread Size : M20X1.5-6H
Gasket Type : Square

CONT : 25
VOL : 0.047

Note : absolute micron rating 7.78, double layer media

C-57430 Oil Filter Full Flow Spin-On Synthetic Media

CUMMINS 4367100
KOMATSU 600-211-1340



H 1 : 300 (mm)
OD 1 : 118 (mm)
Thread Size : M95X2.5-7H

CONT : 6
VOL : 0.031

Note : upgrade of C-5710,C-5724

F-5210 Fuel Filter Metal End Cap Element

YANMAR 129100-55650
KUBOTA 15521-43160
KUBOTA 607



H 1 : 89 (mm)
OD 1 : 50 (mm)
OD 2 : 50 (mm)
ID 1 : 20 (mm)

CONT : 50
VOL : 0.017

FC-57290 Fuel Filter Spin-On High Efficiency

CUMMINS 4964234



H 1 : 262 (mm)
OD 1 : 118 (mm)
Thread Size : 2 1/4-12 UNF-2B

CONT : 6
VOL : 0.032

FS-1004 Fuel Filter Metal framed In-Line



BMW 1256425
BMW 13321256492
FORD D3FZ-9155-A

H 1 : 97 (mm)
H 2 : 61 (mm)
OD 1 : 44 (mm)
OD 2 : 50.4 (mm)
Inlet : 8 (mm)
Outlet : 8 (mm)

CONT : 50
VOL : 0.019

46

O-5702 Oil Filter Full Flow Metal End Cap Element



CUMMINS 158139
KOMATSU 6610-51-5100
KOMATSU CULF-516

H 1 : 249 (mm)
H 2 : 244.5 (mm)
OD 1 : 126 (mm)
OD 2 : 126 (mm)
ID 1 : 39 (mm)
ID 2 : 39 (mm)

CONT : 9
VOL : 0.013

Note : Paper Protector

51

SFC-5521 Fuel/Water Separator Spin-On



CUMMINS 4010651
CASE 419858A1
NEW HOLLAND (CNH) 441701A1
INGERSOLL RAND 54662036

H 1 : 293.5 (mm)
OD 1 : 118 (mm)
Thread Size : M85X2-7H

CONT : 6
VOL : 0.035

56

FS-5701 Fuel Filter Metal body In-Line



CUMMINS 3826094
NEW HOLLAND (CNH) 86597473

H 1 : 96 (mm)
OD 1 : 44.5 (mm)
Inlet : 10 (mm)
Outlet : 10 (mm)

CONT : 12
VOL : 0.005

47

O-5703 Oil Filter Full Flow Metal End Cap Element



FORD 1461524
CUMMINS 173174
FORD 68MF6731BAA

H 1 : 195 (mm)
H 2 : 189 (mm)
OD 1 : 121 (mm)
OD 2 : 121 (mm)
ID 1 : 38.5 (mm)
ID 2 : 39 (mm)

CONT : 12
VOL : 0.046

52

SFC-55230 Fuel/Water Separator Spin-On High Efficiency



CUMMINS 3942533
AG CHEM EQUIPMENT 723720
CASE J942533

H 1 : 144 (mm)
OD 1 : 93 (mm)
Thread Size : M20X1.5-6H
Thread Nut Size : 1 1/4"X10
Gasket Type : Square

CONT : 12
VOL : 0.020

57

H-5609 Hydraulic Oil Filter Metal End Cap Element Cellulose media



KOMATSU 07063-01142
KOMATSU 07063-01412
KOMATSU 195-60-16320

H 1 : 300.5 (mm)
OD 1 : 150 (mm)
OD 2 : 150 (mm)
ID 1 : 110 (mm)
ID 2 : 110 (mm)

CONT : 6
VOL : 0.059

48

O-5705 Oil Filter By Pass Can-type Depth



CUMMINS 256839

H 1 : 248 (mm)
OD 1 : 196.5 (mm)
OD 2 : 196.5 (mm)
ID 1 : 27 (mm)
ID 2 : 27 (mm)

CONT : 9
VOL : 0.120

53

SFC-5601-02 Fuel/Water Separator Spin-On High Efficiency



CUMMINS 3089916
KOMATSU 600-311-3110
KOMATSU 600-311-3111
KOMATSU 600-319-3111A

H 1 : 311.4 (mm)
H 2 : 286 (mm)
OD 1 : 118 (mm)
Thread Size : 1 1/4-12 UNF-2B

CONT : 6
VOL : 0.037

Note : High efficiency filter for high pressure fuel injection systems

58

H-5618 Hydraulic Oil Filter Metal End Cap Element



MITSUBISHI 385-10100021
MITSUBISHI 385-10100022
KOMATSU 424-16-11140

H 1 : 229.6 (mm)
H 2 : 227 (mm)
OD 1 : 110 (mm)
OD 2 : 110 (mm)
ID 1 : 44 (mm)
ID 2 : 44 (mm)

CONT : 20
VOL : 0.075

49

SF-79080 Fuel/Water Separator Metal End Cap Element



DAVCO 102527

H 1 : 180 (mm)
H 2 : 173 (mm)
OD 1 : 106.5 (mm)
OD 2 : 106.5 (mm)
ID 1 : 16.8 (mm)

CONT : 12
VOL : 0.036

Note : 10 micron

54

SFC-5701-10 Fuel/Water Separator Spin-On 10 Micron



CASE 335341A1
CUMMINS 3413084
DAEWOO 65125035016

H 1 : 174 (mm)
OD 1 : 93 (mm)
Thread Size : 1-14 UNS-2B
Gasket Type : Square

CONT : 12
VOL : 0.030

59

O-5603 Oil Filter Full Flow Metal End Cap Element



KOMATSU 6610-50-4400
KOMATSU 6610-50-5100
KOMATSU 6610-51-4400

H 1 : 237 (mm)
H 2 : 231 (mm)
OD 1 : 128 (mm)
OD 2 : 128 (mm)
ID 1 : 56.4 (mm)
ID 2 : 56.4 (mm)

CONT : 25
VOL : 0.134

Note : Paper Protector

50

SFC-55200 Fuel/Water Separator Spin-On



CUMMINS 3991498

H 1 : 192 (mm)
OD 1 : 93 (mm)
Thread Size : M20X1.5-6H
Gasket Type : Square

CONT : 12
VOL : 0.026

55

SFC-5711 Fuel/Water Separator Spin-On



CUMMINS 3973233
CASE 87356193
NEW HOLLAND (CNH) 87356194

H 1 : 164 (mm)
OD 1 : 93 (mm)
Thread Size : 1-14 UNS-2B
Gasket Type : Square

CONT : 12
VOL : 0.032

60

SFC-7924

Fuel/Water Separator Spin-On

NEW HOLLAND (CNH) 86504140
CASE J911213



H 1 : 111 (mm)
H 2 : 86 (mm)
OD 1 : 76 (mm)
Thread Size : M16X1.5-6H
Gasket Type : Square

CONT : 12
VOL : 0.012

Note : With drain plug

61

WC-5703

Coolant Filter Spin-On

CUMMINS 3318319
HITACHI 4266063
KOMATSU 6742-01-3490



H 1 : 136 (mm)
OD 1 : 93 (mm)
Thread Size : 11/16-16 UNF-2B
Gasket Type : Square

CONT : 12
VOL : 0.022

Note : Coolants = 23 units

62

WC-5705

Coolant Filter Spin-On

CUMMINS 299080
CUMMINS 3100304
CUMMINS 3305367



H 1 : 100 (mm)
OD 1 : 93 (mm)
Thread Size : 11/16-16 UNF-2B
Gasket Type : Square

CONT : 12
VOL : 0.018

Note : Coolants = 4 units

63

WC-57160

Coolant Filter Spin-On Synthetic Media

CUMMINS 3098688



H 1 : 136 (mm)
OD 1 : 93 (mm)
Thread Size : 11/16-16 UNF-2B
Gasket Type : Square

CONT : 12
VOL : 0.021

64