



SAKURA

CATERPILLAR

FILTER SUB-CATALOGUE





Table of Contents

Engine Application

A

Technical Specification

B



Engine Application

A

Sakura Filter

ENGINE APPLICATION

MODEL/APPLICATION	SAKURA NO	MODEL/APPLICATION	SAKURA NO	MODEL/APPLICATION	SAKURA NO
CATERPILLAR		CATERPILLAR		CATERPILLAR	
1090 (<i>FELLER BUNCHERS</i>)		Air Filter Primary.....	A-5511	112F (<i>MOTOR GRADERS</i>) S/N: 89J1689-UP	
Air Filter.....	A-5584	Fuel Filter.....	F-5501	Air Filter Set.....	A-5507-S
Air Filter Secondary.....	A-8651	Oil Filter Full Flow.....	O-5404	Air Filter Primary.....	A-5507
Hydraulic Oil Filter.....	HC-55170	Oil Filter Full Flow.....	O-5501	Air Filter Secondary.....	A-5567
Hydraulic Oil Filter.....	HC-5801			Air Filter Set.....	A-5568-S
112 (<i>MOTOR GRADERS</i>) S/N: 2M-UP		112E (<i>MOTOR GRADERS</i>) S/N: 72H,91G-UP		Air Filter Secondary.....	A-5508
Oil Filter Full Flow.....	O-5404	Air Filter Primary.....	A-5511	Air Filter Set.....	A-55071-S
Oil Filter Full Flow.....	O-5505	Air Filter Set.....	A-5511-S	Air Filter Set.....	A-5566
112 (<i>MOTOR GRADERS</i>) S/N: 3U1-2816		Air Filter Secondary.....	A-5512	Fuel Filter Secondary.....	FC-5507
Oil Filter Full Flow.....	O-5505	Fuel Filter.....	F-5501	Oil Filter Full Flow.....	O-5404
Oil Filter Full Flow.....	O-5404	Hydraulic Oil Filter.....	H-5502	Oil Filter Full Flow.....	C-5510
112 (<i>MOTOR GRADERS</i>) S/N: 3U2817-UP		Hydraulic Oil Filter.....	H-5508	112F (<i>MOTOR GRADERS</i>) S/N: 89J1-UP	
Oil Filter Full Flow.....	O-5404	Oil Filter Full Flow.....	O-5501	Air Filter Primary.....	A-5566
Oil Filter Full Flow.....	O-5501	Oil Filter Full Flow.....	O-5404	Air Filter Set.....	A-55071-S
112 (<i>MOTOR GRADERS</i>) S/N: 4M-UP		112F (<i>MOTOR GRADERS</i>) S/N: 46D1-UP		Air Filter Secondary.....	A-5508
Oil Filter Full Flow.....	O-5404	Air Filter Primary.....	A-5507	Air Filter Set.....	A-5568-S
Oil Filter Full Flow.....	O-5505	Air Filter Set.....	A-5507-S	Air Filter Secondary.....	A-5567
112 (<i>MOTOR GRADERS</i>) S/N: 68E1-UP		Air Filter Set.....	A-55071-S	Air Filter Primary.....	A-5507
Air Filter Primary.....	A-5511	Air Filter Secondary.....	A-5508	Air Filter Set.....	A-5507-S
Air Filter Set.....	A-5511-S	Air Filter Set.....	A-5568-S	Fuel Filter.....	F-5501
Air Filter Secondary.....	A-5512	Air Filter Secondary.....	A-5567	Oil Filter Full Flow.....	O-5502
Air Filter Primary.....	A-5566	Air Filter Set.....	A-5567	Oil Filter Full Flow.....	O-5404
Air Filter Secondary.....	A-5567	Air Filter Secondary.....	A-5507-S	120 (<i>MOTOR GRADERS</i>)	
Air Filter Set.....	A-5568-S	Air Filter Secondary.....	A-5567	Fuel Filter.....	F-5503
Fuel Filter.....	F-5501	Air Filter Set.....	A-5568-S	120 (<i>MOTOR GRADERS</i>) S/N: 10R1-2143	
Oil Filter Full Flow.....	O-5404	Air Filter Primary.....	A-5566	Air Filter Primary.....	A-5509
Oil Filter Full Flow.....	O-5502	Fuel Filter.....	F-5501	Air Filter Secondary.....	A-5510
112 (<i>MOTOR GRADERS</i>) S/N: 81C1-UP		Oil Filter Full Flow.....	O-5404	Air Filter Set.....	A-5522-S
Air Filter Set.....	A-5568-S	Oil Filter Full Flow.....	O-5502	Air Filter Primary.....	A-5549
Air Filter Secondary.....	A-5567	112F (<i>MOTOR GRADERS</i>) S/N: 80J1-UP		Air Filter Primary.....	A-5549M
Air Filter Primary.....	A-5566	Fuel Filter Secondary.....	FC-5507	Air Filter Set.....	A-5549M-S
112 (<i>MOTOR GRADERS</i>) S/N: 81C-UP		Oil Filter Full Flow.....	C-5510	Air Filter Secondary.....	A-5550
Oil Filter Full Flow.....	O-5501	112F (<i>MOTOR GRADERS</i>) S/N: 82F1-UP		Fuel Filter Secondary.....	FC-5507
Oil Filter Full Flow.....	O-5404	Air Filter Primary.....	A-5566	Oil Filter Full Flow.....	O-5404
112 (<i>MOTOR GRADERS</i>) S/N: 91G1-UP		Air Filter Set.....	A-5507-S	Oil Filter Full Flow.....	O-5502
Air Filter Primary.....	A-5566	Air Filter Primary.....	A-5507	120 (<i>MOTOR GRADERS</i>) S/N: 10R2144-UP	
Air Filter Secondary.....	A-5567	Air Filter Secondary.....	A-5567	Air Filter Secondary.....	A-5550
Air Filter Set.....	A-5568-S	Air Filter Set.....	A-5568-S	Air Filter Set.....	A-5549M-S
Air Filter Secondary.....	A-5512	Air Filter Primary.....	A-5507	Air Filter Primary.....	A-5549M
Air Filter Set.....	A-5511-S	Air Filter Secondary.....	A-5567	Air Filter Primary.....	A-5549
Air Filter Primary.....	A-5511	Air Filter Set.....	A-5507-S	Air Filter Set.....	A-5522-S
Fuel Filter.....	F-5501	Air Filter Secondary.....	A-5508	Air Filter Secondary.....	A-5510
Oil Filter Full Flow.....	O-5404	Air Filter Set.....	A-5568-S	Air Filter Primary.....	A-5509
Oil Filter Full Flow.....	O-5502	Air Filter Secondary.....	A-5507-S	Fuel Filter Secondary.....	FC-5507
112E (<i>MOTOR GRADERS</i>) S/N: 68E-UP		Fuel Filter.....	F-5501	Oil Filter Full Flow.....	C-5510
Air Filter Secondary.....	A-5512	Oil Filter Full Flow.....	O-5404	Oil Filter Full Flow.....	O-5404
Air Filter Set.....	A-5511-S	Oil Filter Full Flow.....	O-5502	120 (<i>MOTOR GRADERS</i>) S/N: 13U1-681	
		112F (<i>MOTOR GRADERS</i>) S/N: 89J1-1688		Air Filter Primary.....	A-5509
		Air Filter Primary.....	A-5566	Air Filter Secondary.....	A-5510
		Air Filter Set.....	A-55071-S	Air Filter Set.....	A-5522-S
		Air Filter Secondary.....	A-5508	Air Filter Primary.....	A-5549
		Air Filter Set.....	A-5568-S	Air Filter Primary.....	A-5549M
		Air Filter Secondary.....	A-5507-S		
		Fuel Filter Secondary.....	FC-5507		
		Oil Filter Full Flow.....	O-5502		
		Oil Filter Full Flow.....	O-5404		

MODEL/APPLICATION	SAKURA NO
-------------------	-----------

CATERPILLAR

120
(MOTOR GRADERS)
S/N: 13U1-681

Air Filter Set.....	A-5549M-S
Air Filter Secondary.....	A-5550
Fuel Filter Secondary.....	FC-5507
Hydraulic Oil Filter.....	H-5504
Oil Filter Full Flow.....	O-5404
Oil Filter Full Flow.....	O-5502

120
(MOTOR GRADERS)
S/N: 13U942-UP

Air Filter Secondary.....	A-5550
Air Filter Set.....	A-5549M-S
Air Filter Primary.....	A-5549M
Air Filter Primary.....	A-5549
Air Filter Set.....	A-5522-S
Air Filter Secondary.....	A-5510
Air Filter Primary.....	A-5509
Fuel Filter Secondary.....	FC-5507
Hydraulic Oil Filter.....	H-5504
Oil Filter Full Flow.....	C-5510
Oil Filter Full Flow.....	O-5404

120
(MOTOR GRADERS)
S/N: 14K1-UP

Air Filter Primary.....	A-5509
Air Filter Secondary.....	A-5510
Air Filter Set.....	A-5522-S
Air Filter Primary.....	A-5549
Air Filter Primary.....	A-5549M
Air Filter Set.....	A-5549M-S
Air Filter Secondary.....	A-5550
Fuel Filter Secondary.....	FC-5507
Oil Filter Full Flow.....	O-5404
Oil Filter Full Flow.....	O-5502

120
(MOTOR GRADERS)
S/N: 22R1-941

Air Filter Set.....	A-5549M-S
Air Filter Primary.....	A-5549M
Air Filter Primary.....	A-5549
Air Filter Set.....	A-5522-S
Air Filter Secondary.....	A-5510
Air Filter Primary.....	A-5509
Air Filter Secondary.....	A-5550
Fuel Filter Secondary.....	FC-5507
Oil Filter Full Flow.....	O-5404
Oil Filter Full Flow.....	O-5502

120
(MOTOR GRADERS)
S/N: 22R942-UP

Air Filter Secondary.....	A-5550
Air Filter Primary.....	A-5509
Air Filter Secondary.....	A-5510
Air Filter Set.....	A-5522-S
Air Filter Primary.....	A-5549
Air Filter Primary.....	A-5549M
Air Filter Set.....	A-5549M-S
Fuel Filter Secondary.....	FC-5507
Oil Filter Full Flow.....	O-5404
Oil Filter Full Flow.....	C-5510

MODEL/APPLICATION	SAKURA NO
-------------------	-----------

CATERPILLAR

120
(MOTOR GRADERS)
S/N: 64U1-UP

Air Filter Secondary.....	A-5550
Air Filter Secondary.....	A-5510
Air Filter Primary.....	A-5509
Air Filter Set.....	A-5549M-S
Air Filter Primary.....	A-5549M
Air Filter Primary.....	A-5549
Air Filter Set.....	A-5522-S
Fuel Filter Secondary.....	FC-5507
Oil Filter Full Flow.....	O-5404
Oil Filter Full Flow.....	C-5510

120H
(MOTOR GRADERS)
CAT 3126B (S/N: 2AN1-UP)

Air Filter Primary.....	A-5566
Air Filter Secondary.....	A-5567
Air Filter Set.....	A-5568-S
Fuel Filter.....	FC-5508
Fuel Filter Secondary.....	FC-5515
Fuel Filter Secondary.....	FC-55151
Fuel Filter.....	FC-5516
Hydraulic Oil Filter.....	H-5506
Hydraulic Oil Filter.....	H-5504
Oil Filter Full Flow.....	C-5510

120H
(MOTOR GRADERS)
CAT 3126B (S/N: 4MK1-UP)

Air Filter Set.....	A-5568-S
Air Filter Secondary.....	A-5567
Air Filter Primary.....	A-5566
Cabin Air Filter.....	CA-5501
Fuel Filter.....	FC-5516
Fuel Filter Secondary.....	FC-55151
Fuel Filter Secondary.....	FC-5515
Fuel Filter.....	FC-5508
Hydraulic Oil Filter.....	H-5504
Hydraulic Oil Filter.....	H-55270
Hydraulic Oil Filter.....	H-5506
Oil Filter Full Flow.....	C-5510

120H
(MOTOR GRADERS)
S/N: 5FM1-UP

Air Filter Primary.....	A-5566
Air Filter Secondary.....	A-5567
Air Filter Set.....	A-5568-S
Fuel Filter Secondary.....	FC-5515
Fuel Filter Secondary.....	FC-55151
Fuel Filter.....	FC-5516
Fuel Filter.....	FC-5508
Hydraulic Oil Filter.....	H-5506
Hydraulic Oil Filter.....	H-55270
Oil Filter Full Flow.....	C-5510

120H
(MOTOR GRADERS)
S/N: 6NM1-UP

Air Filter Set.....	A-5568-S
Air Filter Secondary.....	A-5567
Air Filter Primary.....	A-5566
Fuel Filter.....	FC-5508
Fuel Filter.....	FC-5516
Fuel Filter Secondary.....	FC-55151
Fuel Filter Secondary.....	FC-5515

MODEL/APPLICATION	SAKURA NO
-------------------	-----------

CATERPILLAR

Hydraulic Oil Filter.....	H-55270
Hydraulic Oil Filter.....	H-5504
Hydraulic Oil Filter.....	H-5506
Oil Filter Full Flow.....	C-5510

120H
(MOTOR GRADERS)
S/N: 6TM1-UP

Air Filter Primary.....	A-5566
Air Filter Secondary.....	A-5567
Air Filter Set.....	A-5568-S
Fuel Filter Secondary.....	FC-5515
Fuel Filter Secondary.....	FC-55151
Fuel Filter.....	FC-5516
Fuel Filter.....	FC-5508
Hydraulic Oil Filter.....	H-5506
Hydraulic Oil Filter.....	H-5504
Hydraulic Oil Filter.....	H-55270
Oil Filter Full Flow.....	C-5510

120H
(MOTOR GRADERS)
S/N: 6YN1-UP

Air Filter Set.....	A-5568-S
Air Filter Secondary.....	A-5567
Air Filter Primary.....	A-5566
Fuel Filter.....	FC-5516
Fuel Filter Secondary.....	FC-55151
Fuel Filter Secondary.....	FC-5515
Fuel Filter.....	FC-5508
Hydraulic Oil Filter.....	H-55270
Hydraulic Oil Filter.....	H-5506
Oil Filter Full Flow.....	C-5510

120H
(MOTOR GRADERS)
S/N: 9YR1-UP

Air Filter Primary.....	A-5566
Air Filter Secondary.....	A-5567
Air Filter Set.....	A-5568-S
Fuel Filter.....	FC-5508
Fuel Filter Secondary.....	FC-5515
Fuel Filter Secondary.....	FC-55151
Fuel Filter.....	FC-5516
Hydraulic Oil Filter.....	H-5506
Hydraulic Oil Filter.....	H-55270
Oil Filter Full Flow.....	C-5510

120H
(MOTOR GRADERS)
S/N: ALZ1-UP

Air Filter Set.....	A-5573-S
Air Filter Primary.....	A-5535
Air Filter Secondary.....	A-5534
Cabin Air Filter.....	CA-5501
Fuel Filter.....	FC-5517
Hydraulic Oil Filter.....	H-5506

120H
(MOTOR GRADERS)
S/N: CAF1-UP

Air Filter Secondary.....	A-5534
Air Filter Primary.....	A-5535
Air Filter Set.....	A-5573-S
Cabin Air Filter.....	CA-5501
Fuel Filter.....	FC-5517
Hydraulic Oil Filter.....	H-5506

Sakura Filter

ENGINE APPLICATION

MODEL/APPLICATION	SAKURA NO	MODEL/APPLICATION	SAKURA NO	MODEL/APPLICATION	SAKURA NO
CATERPILLAR		CATERPILLAR		CATERPILLAR	
120H (MOTOR GRADERS) w/3126B Eng.		Hydraulic Oil Filter.....	H-55270	12 (MOTOR GRADERS) S/N: 38E-38E	
Air Filter Primary.....	A-5535M	Hydraulic Oil Filter.....	H-5504	Air Filter Set.....	A-55071-S
Air Filter Set.....	A-5573M-S	120G (MOTOR GRADERS) S/N: 82V1-UP		Air Filter Secondary.....	A-5508
Cabin Air Filter.....	CA-55150	Air Filter Secondary.....	A-5508	Air Filter Set.....	A-5507-S
120B (MOTOR GRADERS) CAT 3306 (S/N: 32C100-UP)		Air Filter Set.....	A-55071-S	Air Filter Primary.....	A-5507
Air Filter Set.....	A-5522-S	Air Filter Set.....	A-5507-S	Oil Filter Full Flow.....	0-5501
Air Filter Secondary.....	A-5510	Air Filter Primary.....	A-5507	Oil Filter Full Flow.....	0-5404
Air Filter Primary.....	A-5509	Air Filter Set.....	A-5568-S	12 (MOTOR GRADERS) S/N: 5M-UP	
Fuel Filter Secondary.....	FC-5507	Air Filter Secondary.....	A-5567	Oil Filter Full Flow.....	0-5505
Oil Filter Full Flow.....	0-5404	Air Filter Primary.....	A-5566	12 (MOTOR GRADERS) S/N: 6M-UP	
Oil Filter Full Flow.....	C-5510	Fuel Filter Secondary.....	FC-5507	Oil Filter Full Flow.....	0-5505
120G (MOTOR GRADERS) S/N: 11W1251-UP		Hydraulic Oil Filter.....	H-5504	12 (MOTOR GRADERS) S/N: 70D-70D	
Air Filter Secondary.....	A-5508	Oil Filter Full Flow.....	C-5510	Air Filter Secondary.....	A-5508
Air Filter Set.....	A-55071-S	120G (MOTOR GRADERS) S/N: 87V1-UP		Air Filter Set.....	A-55071-S
Air Filter Set.....	A-5507-S	Air Filter Primary.....	A-5566	Air Filter Set.....	A-5507-S
Air Filter Primary.....	A-5507	Air Filter Secondary.....	A-5567	Air Filter Primary.....	A-5507
Air Filter Set.....	A-5568-S	Air Filter Set.....	A-5568-S	Oil Filter Full Flow.....	0-5404
Air Filter Secondary.....	A-5567	Air Filter Primary.....	A-5507	Oil Filter Full Flow.....	0-5501
Air Filter Primary.....	A-5566	Air Filter Set.....	A-5507-S	12 (MOTOR GRADERS) S/N: 71D-71D	
Hydraulic Oil Filter.....	H-55270	Air Filter Set.....	A-55071-S	Air Filter Primary.....	A-5507
Hydraulic Oil Filter.....	H-5504	Air Filter Secondary.....	A-5508	Air Filter Set.....	A-55071-S
120G (MOTOR GRADERS) S/N: 4HD1-702		Fuel Filter Secondary.....	FC-5507	Air Filter Set.....	A-5507-S
Air Filter Primary.....	A-5566	Hydraulic Oil Filter.....	H-5504	Air Filter Secondary.....	A-5508
Air Filter Secondary.....	A-5567	Oil Filter Full Flow.....	C-5510	Oil Filter Full Flow.....	0-5404
Air Filter Set.....	A-5568-S	120G (MOTOR GRADERS) S/N: 87V8319-8359		Oil Filter Full Flow.....	0-5501
Air Filter Primary.....	A-5507	Hydraulic Oil Filter.....	H-5504	12 (MOTOR GRADERS) S/N: 7T-7T	
Air Filter Set.....	A-5507-S	Hydraulic Oil Filter.....	H-55270	Oil Filter Full Flow.....	0-5505
Air Filter Set.....	A-55071-S	120G (MOTOR GRADERS) S/N: 87V8360-UP		Oil Filter Full Flow.....	0-5404
Air Filter Secondary.....	A-5508	Air Filter Secondary.....	A-5508	Oil Filter Full Flow.....	0-5501
Hydraulic Oil Filter.....	H-55270	Air Filter Set.....	A-55071-S	12 (MOTOR GRADERS) S/N: 80C-80C	
Hydraulic Oil Filter.....	H-5504	Air Filter Set.....	A-5507-S	Air Filter Secondary.....	A-5508
120G (MOTOR GRADERS) S/N: 4HD1-UP		Air Filter Primary.....	A-5507	Air Filter Set.....	A-55071-S
Air Filter Secondary.....	A-5508	Air Filter Set.....	A-5568-S	Air Filter Set.....	A-5507-S
Air Filter Set.....	A-55071-S	Air Filter Secondary.....	A-5567	Air Filter Primary.....	A-5507
Air Filter Set.....	A-5507-S	Air Filter Primary.....	A-5566	Oil Filter Full Flow.....	0-5501
Air Filter Primary.....	A-5507	Hydraulic Oil Filter.....	H-55270	Oil Filter Full Flow.....	0-5404
Air Filter Set.....	A-5568-S	Hydraulic Oil Filter.....	H-5504	12 (MOTOR GRADERS) S/N: 8T1-1859	
Air Filter Secondary.....	A-5567	120G (MOTOR GRADERS) w/3304 Eng.		Oil Filter Full Flow.....	0-5505
Air Filter Primary.....	A-5566	Hydraulic Oil Filter.....	H-55320	Oil Filter Full Flow.....	0-5404
Fuel Filter.....	F-5505	120H NA (MOTOR GRADERS) S/N: 2AN1-UP		12 (MOTOR GRADERS) S/N: 8T-8T	
Fuel Filter Secondary.....	FC-5507	Oil Filter Full Flow.....	C-5510	Air Filter Set.....	A-55071-S
Hydraulic Oil Filter.....	H-55270	120H ES (MOTOR GRADERS)		Air Filter Secondary.....	A-5508
Hydraulic Oil Filter.....	H-5504	Air Filter Primary.....	A-5566	Air Filter Set.....	A-5507-S
Oil Filter Full Flow.....	C-5510	Air Filter Secondary.....	A-5567	Air Filter Primary.....	A-5507
120G (MOTOR GRADERS) S/N: 4HD703-UP		Air Filter Set.....	A-5568-S	Oil Filter Full Flow.....	0-5501
Air Filter Primary.....	A-5566	Cabin Air Filter.....	CA-5501	Oil Filter Full Flow.....	0-5404
Air Filter Secondary.....	A-5567	Fuel Filter.....	FC-5508	12 (MOTOR GRADERS) S/N: 94C-94C	
Air Filter Set.....	A-5568-S	Fuel Filter.....	FC-5516	Air Filter Set.....	A-55071-S
Air Filter Primary.....	A-5507	Fuel Filter Secondary.....	FC-55151	Air Filter Secondary.....	A-5508
Air Filter Set.....	A-5507-S	Fuel Filter Secondary.....	FC-5515	Air Filter Primary.....	A-5507
Air Filter Set.....	A-55071-S	Hydraulic Oil Filter.....	H-55270	Oil Filter Full Flow.....	0-5501
Air Filter Secondary.....	A-5508			Oil Filter Full Flow.....	0-5404

MODEL/APPLICATION	SAKURA NO
CATERPILLAR	
12 (MOTOR GRADERS) S/N: 94C-94C	
Air Filter Primary.....	A-5507
Air Filter Set.....	A-5507-S
Air Filter Secondary.....	A-5508
Air Filter Set.....	A-55071-S
Oil Filter Full Flow.....	0-5404
Oil Filter Full Flow.....	0-5501
12 (MOTOR GRADERS) S/N: 9K-9K	
Oil Filter Full Flow.....	0-5505
Oil Filter Full Flow.....	0-5404
120E (MOTOR GRADERS)	
Air Filter Primary.....	A-5509
Air Filter Secondary.....	A-5510
Air Filter Set.....	A-5522-S
Air Filter Secondary.....	A-5550
Air Filter Set.....	A-5549M-S
Air Filter Primary.....	A-5549M
Air Filter Primary.....	A-5549
Hydraulic Oil Filter.....	H-5504
Oil Filter Full Flow.....	0-5404
Oil Filter Full Flow.....	0-5502
Oil Filter Full Flow.....	C-5510
120M (MOTOR GRADERS) CAT C6.6	
Cabin Air Filter.....	CA-55110
Hydraulic Oil Filter Transmission..	EH-55010
12E (MOTOR GRADERS) S/N: 12F1-UP	
Oil Filter Full Flow.....	0-5404
12E (MOTOR GRADERS) S/N: 17K1-UP	
Fuel Filter Secondary.....	FC-5507
Oil Filter Full Flow.....	0-5404
12E (MOTOR GRADERS) S/N: 21F1-UP	
Oil Filter Full Flow.....	0-5404
12E (MOTOR GRADERS) S/N: 99E1-UP	
Air Filter Secondary.....	A-5508
Air Filter Set.....	A-55071-S
Air Filter Set.....	A-5507-S
Air Filter Primary.....	A-5507
Air Filter Set.....	A-5568-S
Air Filter Secondary.....	A-5567
Air Filter Primary.....	A-5566
Fuel Filter.....	F-5501
Oil Filter Full Flow.....	0-5404
Oil Filter Full Flow.....	0-5502
12F (MOTOR GRADERS)	
Fuel Filter.....	F-5503
12F (MOTOR GRADERS) S/N: 13K1-4567	
Air Filter Primary.....	A-5549

MODEL/APPLICATION	SAKURA NO
CATERPILLAR	
Air Filter Primary.....	A-5549M
Air Filter Set.....	A-5549M-S
Air Filter Secondary.....	A-5550
Air Filter Primary.....	A-5509
Air Filter Set.....	A-5522-S
Air Filter Secondary.....	A-5510
Fuel Filter Secondary.....	FC-5507
Oil Filter Full Flow.....	0-5404
Oil Filter Full Flow.....	0-5502
12F (MOTOR GRADERS) S/N: 13K4568-UP	
Air Filter Secondary.....	A-5550
Air Filter Set.....	A-5549M-S
Air Filter Primary.....	A-5549M
Air Filter Primary.....	A-5549
Air Filter Secondary.....	A-5510
Air Filter Set.....	A-5522-S
Air Filter Primary.....	A-5509
Fuel Filter Secondary.....	FC-5507
Oil Filter Full Flow.....	C-5510
Oil Filter Full Flow.....	0-5404
12F (MOTOR GRADERS) S/N: 73G1-UP	
Air Filter Primary.....	A-5509
Air Filter Set.....	A-5522-S
Air Filter Secondary.....	A-5510
Air Filter Primary.....	A-5549
Air Filter Primary.....	A-5549M
Air Filter Set.....	A-5549M-S
Air Filter Secondary.....	A-5550
Fuel Filter.....	F-5501
Hydraulic Oil Filter.....	H-5508
Hydraulic Oil Filter.....	H-5502
Oil Filter Full Flow.....	0-5502
Oil Filter Full Flow.....	0-5404
12F (MOTOR GRADERS) S/N: 89H1-1224	
Air Filter Secondary.....	A-5510
Air Filter Set.....	A-5522-S
Air Filter Primary.....	A-5509
Air Filter Secondary.....	A-5550
Air Filter Set.....	A-5549M-S
Air Filter Primary.....	A-5549M
Air Filter Primary.....	A-5549
Fuel Filter.....	F-5501
Fuel Filter Secondary.....	FC-5507
Hydraulic Oil Filter.....	H-5502
Hydraulic Oil Filter.....	H-5504
Hydraulic Oil Filter.....	H-5508
Oil Filter Full Flow.....	0-5502
12F (MOTOR GRADERS) S/N: 89H1225-UP	
Air Filter Primary.....	A-5549
Air Filter Primary.....	A-5549M
Air Filter Set.....	A-5549M-S
Air Filter Secondary.....	A-5550
Air Filter Primary.....	A-5509
Air Filter Set.....	A-5522-S
Air Filter Secondary.....	A-5510

MODEL/APPLICATION	SAKURA NO
CATERPILLAR	
Fuel Filter Secondary.....	FC-5507
Fuel Filter.....	F-5501
Hydraulic Oil Filter.....	H-5508
Hydraulic Oil Filter.....	H-5504
Hydraulic Oil Filter.....	H-5502
Oil Filter Full Flow.....	C-5510
12G (MOTOR GRADERS) CAT 3306	
Air Filter Set.....	A-55071-S
Air Filter Secondary.....	A-5508
Air Filter Primary.....	A-5507
Air Filter Set.....	A-5507-S
Fuel Filter Secondary.....	FC-5507
Hydraulic Oil Filter.....	H-5504
Hydraulic Oil Filter.....	H-55270
Oil Filter Full Flow.....	C-5510
12G (MOTOR GRADERS) CAT 3306 (S/N: 3PL1-UP)	
Air Filter Primary.....	A-5566
Air Filter Secondary.....	A-5567
Air Filter Set.....	A-5507-S
Air Filter Primary.....	A-5507
Air Filter Set.....	A-55071-S
Air Filter Set.....	A-5568-S
Fuel Filter.....	F-5505
Fuel Filter Secondary.....	FC-5507
Hydraulic Oil Filter.....	H-5504
Oil Filter Full Flow.....	C-5510
12G (MOTOR GRADERS) CAT 3306 (S/N: 3WC1067-UP)	
Air Filter Set.....	A-55071-S
Air Filter Primary.....	A-5507
Air Filter Set.....	A-5507-S
Air Filter Secondary.....	A-5567
Air Filter Primary.....	A-5566
Air Filter Set.....	A-5568-S
Fuel Filter Secondary.....	FC-5507
Fuel Filter.....	F-5505
Hydraulic Oil Filter.....	H-5504
Oil Filter Full Flow.....	C-5510
12G (MOTOR GRADERS) CAT 3306 (S/N: 61M1-UP)	
Air Filter Set.....	A-5507-S
Air Filter Primary.....	A-5507
Air Filter Set.....	A-55071-S
Air Filter Secondary.....	A-5508
Fuel Filter Secondary.....	FC-5507
Hydraulic Oil Filter.....	H-5504
Oil Filter Full Flow.....	C-5510
12G (MOTOR GRADERS) S/N: 3PL842-UP	
Air Filter Primary.....	A-5566
Air Filter Secondary.....	A-5567
Air Filter Set.....	A-5568-S
12G (MOTOR GRADERS) S/N: 3WC1-1066	
Air Filter Secondary.....	A-5508
Air Filter Set.....	A-55071-S
Air Filter Primary.....	A-5507

MODEL/APPLICATION	SAKURA NO
CATERPILLAR	
12G (MOTOR GRADERS) S/N: 3WC1-1066	
Air Filter Set.....	A-5507-S
Fuel Filter.....	F-5505
Fuel Filter Secondary.....	FC-5507
Hydraulic Oil Filter.....	H-5504
Hydraulic Oil Filter.....	H-55270
Oil Filter Full Flow.....	C-5510
12H (MOTOR GRADERS) S/N: 2GS1-UP	
Air Filter Secondary.....	A-5534
Air Filter Primary.....	A-5535
Air Filter Set.....	A-5573-S
Fuel Filter.....	F-5505
Fuel Filter Secondary.....	FC-5507
Hydraulic Oil Filter.....	H-55270
Hydraulic Oil Filter.....	H-5506
Oil Filter Full Flow.....	C-5510
12H (MOTOR GRADERS) S/N: 2LR1-UP	
Air Filter Set.....	A-5573-S
Air Filter Primary.....	A-5535
Air Filter Secondary.....	A-5534
Fuel Filter Secondary.....	FC-5507
Fuel Filter.....	F-5505
Hydraulic Oil Filter.....	H-55270
Hydraulic Oil Filter.....	H-5506
Hydraulic Oil Filter.....	H-5504
Oil Filter Full Flow.....	C-5510
12H (MOTOR GRADERS) S/N: 2WR1-UP	
Air Filter Secondary.....	A-5534
Air Filter Primary.....	A-5535
Air Filter Set.....	A-5568-S
Air Filter Set.....	A-5573-S
Air Filter Secondary.....	A-5567
Air Filter Primary.....	A-5566
Fuel Filter Secondary.....	FC-5507
Fuel Filter.....	F-5505
Hydraulic Oil Filter.....	H-5504
Hydraulic Oil Filter.....	H-5506
Hydraulic Oil Filter.....	H-55270
Oil Filter Full Flow.....	C-5510
12H (MOTOR GRADERS) S/N: 4ER1-UP	
Air Filter Primary.....	A-5566
Air Filter Set.....	A-5568-S
Air Filter Secondary.....	A-5567
Fuel Filter.....	F-5505
Fuel Filter Secondary.....	FC-5507
Hydraulic Oil Filter.....	H-5506
Hydraulic Oil Filter.....	H-55270
Oil Filter Full Flow.....	C-5510
12H (MOTOR GRADERS) S/N: 4XM1-UP	
Air Filter Secondary.....	A-5567
Air Filter Set.....	A-5573-S
Air Filter Set.....	A-5568-S

MODEL/APPLICATION	SAKURA NO
CATERPILLAR	
Air Filter Primary.....	A-5535
Air Filter Secondary.....	A-5534
Air Filter Primary.....	A-5566
Fuel Filter Secondary.....	FC-5507
Fuel Filter.....	F-5505
Hydraulic Oil Filter.....	H-55270
Hydraulic Oil Filter.....	H-5506
Hydraulic Oil Filter.....	H-5504
Oil Filter Full Flow.....	C-5510
12H (MOTOR GRADERS) S/N: 5ZM1-UP	
Air Filter Primary.....	A-5566
Air Filter Set.....	A-5568-S
Air Filter Secondary.....	A-5567
Fuel Filter.....	F-5505
Fuel Filter Secondary.....	FC-5507
Hydraulic Oil Filter.....	H-55270
Hydraulic Oil Filter.....	H-5504
Hydraulic Oil Filter.....	H-5506
Oil Filter Full Flow.....	C-5510
12H (MOTOR GRADERS) S/N: 8MN1-UP	
Air Filter Set.....	A-5568-S
Air Filter Primary.....	A-5535
Air Filter Secondary.....	A-5534
Air Filter Primary.....	A-5566
Air Filter Secondary.....	A-5567
Air Filter Set.....	A-5573-S
Fuel Filter.....	F-5505
Fuel Filter Secondary.....	FC-5507
Hydraulic Oil Filter.....	H-55270
Hydraulic Oil Filter.....	H-5506
Oil Filter Full Flow.....	C-5510
12H (MOTOR GRADERS) w/3306 Eng.	
Air Filter Set.....	A-5573M-S
Air Filter Primary.....	A-5535M
12H (MOTOR GRADERS) w/C9 Eng.	
Air Filter Set.....	A-5573M-S
Air Filter Primary.....	A-5535M
Cabin Air Filter.....	CA-55150
12H ES (MOTOR GRADERS)	
Air Filter Primary.....	A-5535
Air Filter Secondary.....	A-5534
Air Filter Set.....	A-5573-S
Fuel Filter Secondary.....	FC-5507
Oil Filter Full Flow.....	C-5510
12H ES (MOTOR GRADERS) w/3306 Eng.	
Air Filter Primary.....	A-5535M
Air Filter Set.....	A-5573M-S
12H NA (MOTOR GRADERS)	
Air Filter Set.....	A-5573-S
Air Filter Set.....	A-5568-S
Air Filter Primary.....	A-5566

MODEL/APPLICATION	SAKURA NO
CATERPILLAR	
Air Filter Secondary.....	A-5567
Air Filter Secondary.....	A-5534
Air Filter Primary.....	A-5535
Cabin Air Filter.....	CA-5501
Fuel Filter Secondary.....	FC-5507
Fuel Filter.....	F-5505
Hydraulic Oil Filter.....	H-5506
Hydraulic Oil Filter.....	H-5504
Hydraulic Oil Filter.....	H-55270
Oil Filter Full Flow.....	C-5510
12H NA (MOTOR GRADERS) w/3306 Eng.	
Air Filter Primary.....	A-5535M
Air Filter Set.....	A-5573M-S
12H NA (MOTOR GRADERS) w/3306B ENG.	
Cabin Air Filter.....	CA-55150
12K (MOTOR GRADERS) w/C7 Eng.	
Cabin Air Filter.....	CA-55150
12M (MOTOR GRADERS) CAT C6.6	
Cabin Air Filter.....	CA-55110
12M (MOTOR GRADERS) CAT C7.2	
Cabin Air Filter.....	CA-55110
130G (MOTOR GRADERS) CAT 3304 (S/N: 12W1-UP)	
Air Filter Set.....	A-5507-S
Air Filter Primary.....	A-5507
Air Filter Set.....	A-55071-S
Fuel Filter.....	F-5505
Fuel Filter Secondary.....	FC-5507
Hydraulic Oil Filter.....	H-5504
Oil Filter Full Flow.....	C-5510
130G (MOTOR GRADERS) CAT 3304 (S/N: 74V1-UP)	
Air Filter Set.....	A-55071-S
Air Filter Primary.....	A-5507
Air Filter Set.....	A-5507-S
Fuel Filter Secondary.....	FC-5507
Fuel Filter.....	F-5505
Hydraulic Oil Filter.....	H-5504
Oil Filter Full Flow.....	C-5510
130G (MOTOR GRADERS) S/N: 7GB1224-UP	
Air Filter Set.....	A-5507-S
Air Filter Primary.....	A-5507
Air Filter Secondary.....	A-5508
Air Filter Set.....	A-55071-S
Fuel Filter.....	F-5505
Fuel Filter Secondary.....	FC-5507
Hydraulic Oil Filter.....	H-55270
Hydraulic Oil Filter.....	H-5504
Oil Filter Full Flow.....	C-5510
130G (MOTOR GRADERS) w/3304 Eng.	

Sakura Filter

ENGINE APPLICATION

MODEL/APPLICATION	SAKURA NO	MODEL/APPLICATION	SAKURA NO	MODEL/APPLICATION	SAKURA NO
CATERPILLAR		CATERPILLAR		CATERPILLAR	
140H (MOTOR GRADERS) S/N: 3AS00491-UP		Air Filter Secondary.....	A-5534	Hydraulic Oil Filter.....	H-5504
140H (MOTOR GRADERS) S/N: 3AS1-UP		Fuel Filter Secondary.....	FC-5507	Oil Filter Full Flow.....	C-5510
Air Filter Primary.....	A-5535	Fuel Filter.....	F-5505	140G (MOTOR GRADERS) CAT 3306 (S/N: 81V1-UP)	
Air Filter Set.....	A-5573-S	Hydraulic Oil Filter.....	H-55270	Air Filter Primary.....	A-5509
Air Filter Secondary.....	A-5534	Hydraulic Oil Filter.....	H-5504	Air Filter Set.....	A-5522-S
Fuel Filter.....	F-5505	Oil Filter Full Flow.....	C-5510	Fuel Filter.....	F-5505
Fuel Filter Secondary.....	FC-5507	140H (MOTOR GRADERS) W/3176C ENG.		Fuel Filter Secondary.....	FC-5507
Hydraulic Oil Filter.....	H-5506	Air Filter Primary.....	A-5535M	Hydraulic Oil Filter.....	H-5504
Hydraulic Oil Filter.....	H-55270	Air Filter Set.....	A-5573M-S	Hydraulic Oil Filter.....	HC-5506
Oil Filter Full Flow.....	C-5510	Cabin Air Filter.....	CA-55150	Hydraulic Oil Filter.....	HC-5503
140H (MOTOR GRADERS) S/N: 5HM1-UP		140G (MOTOR GRADERS) w/3306 Eng.		Oil Filter Full Flow.....	C-5510
Air Filter Secondary.....	A-5534	Air Filter Set.....	A-5573M-S	140G (MOTOR GRADERS) S/N: 72V02537-UP	
Air Filter Set.....	A-5573-S	Air Filter Primary.....	A-5535M	Air Filter Secondary.....	A-5522
Air Filter Primary.....	A-5535	140M (MOTOR GRADERS) C9		Air Filter Set.....	A-5522-S
Fuel Filter Secondary.....	FC-5507	Cabin Air Filter.....	CA-55110	Air Filter Primary.....	A-5509
Fuel Filter.....	F-5505	140M (MOTOR GRADERS) CAT C7		Fuel Filter Secondary.....	FC-5507
Hydraulic Oil Filter.....	H-55270	Cabin Air Filter.....	CA-55110	Hydraulic Oil Filter.....	H-5504
Hydraulic Oil Filter.....	H-5506	14 (MOTOR GRADERS) S/N: 35F-35F		Oil Filter Full Flow.....	C-5510
Oil Filter Full Flow.....	C-5510	Fuel Filter.....	F-5501	140G ES (MOTOR GRADERS) w/3306 Eng.	
140H (MOTOR GRADERS) S/N: 83M1-UP		Oil Filter Full Flow.....	O-5501	Air Filter Primary.....	A-5535M
Air Filter Secondary.....	A-5534	Oil Filter Full Flow.....	O-5404	Air Filter Set.....	A-5573M-S
Air Filter Primary.....	A-5535	14 (MOTOR GRADERS) S/N: 64C-64C		140H NA (MOTOR GRADERS) w/3306 Eng.	
Air Filter Set.....	A-5573-S	Oil Filter Full Flow.....	O-5501	Air Filter Primary.....	A-5535M
Fuel Filter.....	F-5505	Oil Filter Full Flow.....	O-5404	Air Filter Set.....	A-5573M-S
Fuel Filter Secondary.....	FC-5507	140G (MOTOR GRADERS) 08Z1-0N		140B (MOTOR GRADERS) S/N: 33C100-UP	
Hydraulic Oil Filter.....	H-5506	Oil Filter Full Flow.....	C-5506	Fuel Filter Secondary.....	FC-5507
Hydraulic Oil Filter.....	H-55270	140G (MOTOR GRADERS) CAT 3306 (S/N: SMD1-UP)		Oil Filter Full Flow.....	O-5404
Hydraulic Oil Filter.....	H-5504	Air Filter Set.....	A-5549M-S	Oil Filter Full Flow.....	C-5510
Oil Filter Full Flow.....	C-5510	Air Filter Secondary.....	A-5550	140B (MOTOR GRADERS) S/N: 61S1-UP	
140H (MOTOR GRADERS) S/N: 8KM1-UP		Air Filter Primary.....	A-5549	Fuel Filter Secondary.....	FC-5507
Air Filter Set.....	A-5573-S	Air Filter Primary.....	A-5549M	Oil Filter Full Flow.....	C-5510
Air Filter Primary.....	A-5535	Air Filter Primary.....	A-5509	Oil Filter Full Flow.....	O-5404
Air Filter Secondary.....	A-5534	Air Filter Secondary.....	A-5522	141 (HYDRAULIC SYSTEMS) S/N: 54G1-UP	
Fuel Filter Secondary.....	FC-5507	Air Filter Set.....	A-5522-S	Hydraulic Oil Filter.....	H-5502
Fuel Filter.....	F-5505	Fuel Filter.....	F-5505	Hydraulic Oil Filter.....	H-5508
Hydraulic Oil Filter.....	H-5504	Fuel Filter Secondary.....	FC-5507	141 (HYDRAULIC SYSTEMS) S/N: 62G7001-UP	
Hydraulic Oil Filter.....	H-55270	Hydraulic Oil Filter.....	H-5504	Hydraulic Oil Filter.....	H-5508
Hydraulic Oil Filter.....	H-5506	Hydraulic Oil Filter.....	HC-5506	Hydraulic Oil Filter.....	H-5502
Oil Filter Full Flow.....	C-5510	Hydraulic Oil Filter.....	HC-5503	143H (MOTOR GRADERS) CAT 3176C ATAAC VHP	
140H (MOTOR GRADERS) S/N: 9TN1-UP		Oil Filter Full Flow.....	C-5510	Air Filter Primary.....	A-5535
Air Filter Secondary.....	A-5534	140G (MOTOR GRADERS) CAT 3306 (S/N: 72V1-UP)		Air Filter Set.....	A-5573-S
Air Filter Primary.....	A-5535	Air Filter Set.....	A-5522-S	Fuel Filter Secondary.....	FC-5507
Air Filter Set.....	A-5573-S	Air Filter Primary.....	A-5509	Fuel Filter.....	F-5505
Fuel Filter.....	F-5505	Fuel Filter Secondary.....	FC-5507	Hydraulic Oil Filter.....	H-5506
Fuel Filter Secondary.....	FC-5507	Fuel Filter.....	F-5505	Hydraulic Oil Filter.....	HC-5508
Hydraulic Oil Filter.....	H-5506	Hydraulic Oil Filter.....	HC-5503	Hydraulic Oil Filter.....	HC-5504
Hydraulic Oil Filter.....	H-55270	Hydraulic Oil Filter.....	HC-5506	140B (MOTOR GRADERS) S/N: 61S1-UP	
Oil Filter Full Flow.....	C-5510	140G (MOTOR GRADERS) CAT 3306 (S/N: SMD1-UP)		Fuel Filter Secondary.....	FC-5507
140H (MOTOR GRADERS) S/N: 9ZN1-UP		Air Filter Set.....	A-5549M-S	Oil Filter Full Flow.....	C-5510
Air Filter Set.....	A-5573-S	Air Filter Secondary.....	A-5550	Oil Filter Full Flow.....	O-5404
Air Filter Primary.....	A-5535	Air Filter Primary.....	A-5549	140B (MOTOR GRADERS) S/N: 61S1-UP	

Sakura Filter

ENGINE APPLICATION

MODEL/APPLICATION	SAKURA NO	MODEL/APPLICATION	SAKURA NO	MODEL/APPLICATION	SAKURA NO
CATERPILLAR		CATERPILLAR		CATERPILLAR	
143H (MOTOR GRADERS) CAT 3176C ATAAC VHP Hydraulic Oil Filter..... H-5504 Oil Filter Full Flow..... C-5510		Oil Filter Full Flow..... 0-5404 Oil Filter Full Flow..... 0-5502 14E (MOTOR GRADERS) S/N: 12K1836-UP Air Filter Secondary..... A-5510 Air Filter Set..... A-5522-S Air Filter Primary..... A-5509 Fuel Filter Secondary..... FC-5507 Fuel Filter..... F-5501 Hydraulic Oil Filter..... H-5508 Hydraulic Oil Filter..... H-5502 Oil Filter Full Flow..... 0-5404 Oil Filter Full Flow..... C-5510		14H (MOTOR GRADERS) CAT 3176C ATAAC (S/N: 7WJ1-UP) Air Filter Secondary..... A-5534 Air Filter Primary..... A-5535 Air Filter Set..... A-5573-S Fuel Filter..... F-5505 Fuel Filter Secondary..... FC-5507 Hydraulic Oil Filter..... H-55270 Hydraulic Oil Filter..... H-5504 Hydraulic Oil Filter..... H-5506 Oil Filter Full Flow..... C-5510	
143H (MOTOR GRADERS) CAT 3176C ATAAC VHP (S/N: 1A11-UP) Air Filter Set..... A-5573-S Air Filter Primary..... A-5535 Air Filter Secondary..... A-5534 Fuel Filter..... F-5505 Fuel Filter Secondary..... FC-5507 Hydraulic Oil Filter..... H-5504 Hydraulic Oil Filter..... H-55270 Hydraulic Oil Filter..... HC-5504 Hydraulic Oil Filter..... H-5506 Oil Filter Full Flow..... C-5510		14E (MOTOR GRADERS) S/N: 72G1030-UP Air Filter Set..... A-5522-S Air Filter Secondary..... A-5510 Air Filter Primary..... A-5509 Air Filter Secondary..... A-5550 Air Filter Primary..... A-5549 Air Filter Primary..... A-5549M Air Filter Set..... A-5549M-S Fuel Filter Secondary..... FC-5507 Hydraulic Oil Filter..... H-5504 Oil Filter Full Flow..... C-5510		14H (MOTOR GRADERS) CAT 3176C ATAAC VHP (S/N: 7WJ1-UP) Air Filter Set..... A-5573-S Air Filter Primary..... A-5535 Air Filter Secondary..... A-5534 Fuel Filter..... F-5505 Fuel Filter Secondary..... FC-5507 Hydraulic Oil Filter..... H-55270 Hydraulic Oil Filter..... H-5506 Hydraulic Oil Filter..... H-5504 Oil Filter Full Flow..... C-5510	
143H (MOTOR GRADERS) W/3176C ENG. Air Filter Set..... A-5573M-S Air Filter Primary..... A-5535M		14E (MOTOR GRADERS) S/N: 72G11029 Air Filter Set..... A-5549M-S Air Filter Primary..... A-5549M Air Filter Primary..... A-5549 Air Filter Secondary..... A-5550 Air Filter Primary..... A-5509 Air Filter Secondary..... A-5510 Air Filter Set..... A-5522-S Fuel Filter Secondary..... FC-5507 Hydraulic Oil Filter..... H-5504 Oil Filter Full Flow..... 0-5502		14H (MOTOR GRADERS) Air Filter Secondary..... A-5534 Air Filter Primary..... A-5535 Air Filter Set..... A-5573-S Cabin Air Filter..... CA-5501 Fuel Filter..... FC-5517 Fuel/Water Separator Secondary.. SFC-5504-10 Fuel/Water Separator Secondary.. SFC-5504-10B Hydraulic Oil Filter..... H-5506 Hydraulic Oil Filter..... H-55270	
143H (MOTOR GRADERS) w/3306 Eng. Air Filter Primary..... A-5535M Air Filter Set..... A-5573M-S		14E (MOTOR GRADERS) S/N: 99G1-UP Air Filter Set..... A-5544-S Air Filter Primary..... A-5558 Air Filter Primary..... A-5543 Air Filter Secondary..... A-5559 Air Filter Secondary..... A-5520 Fuel Filter..... F-5501 Oil Filter Full Flow..... 0-5404 Oil Filter Full Flow..... 0-5502		14H (MOTOR GRADERS) S/N: 6WM1-UP Fuel Filter Secondary..... FC-5507	
143 (HYDRAULIC SYSTEMS) S/N: 36X1-UP Hydraulic Oil Filter..... H-5504		14G (MOTOR GRADERS) CAT 3306 Hydraulic Oil Filter Suction..... H-5516		14H (MOTOR GRADERS) S/N: 7WJ1-10 Fuel Filter Secondary..... FC-5507 Fuel Filter..... FC-5501 Hydraulic Oil Filter..... H-5506 Hydraulic Oil Filter..... H-5504 Oil Filter Full Flow..... C-5510	
14B (MOTOR GRADERS) S/N: 64C-78E Oil Filter Full Flow..... 0-5404 Oil Filter Full Flow..... 0-5501		14G (MOTOR GRADERS) CAT 3306 (S/N: 96U1-UP) Air Filter Secondary..... A-5522 Fuel Filter..... F-5505 Fuel Filter Secondary..... FC-5507 Hydraulic Oil Filter..... H-5504 Oil Filter Full Flow..... C-5510		14H (MOTOR GRADERS) S/N: 7WJ11-UP Air Filter Set..... A-5573-S Air Filter Primary..... A-5535 Air Filter Secondary..... A-5534 Fuel Filter Secondary..... FC-5507 Hydraulic Oil Filter..... H-5504 Hydraulic Oil Filter..... H-5506 Oil Filter Full Flow..... C-5510	
14C (MOTOR GRADERS) S/N: 35F-UP Fuel Filter..... F-5501 Oil Filter Full Flow..... 0-5501 Oil Filter Full Flow..... 0-5404		14E (MOTOR GRADERS) Fuel Filter..... F-5503		14H (MOTOR GRADERS) W/3176C ENG. Air Filter Primary..... A-5535M Air Filter Set..... A-5573M-S	
14D (MOTOR GRADERS) S/N: 96F-UP Fuel Filter..... F-5501 Oil Filter Full Flow..... 0-5404 Oil Filter Full Flow..... 0-5501		14E (MOTOR GRADERS) S/N: 12K1-1835 Air Filter Secondary..... A-5550 Air Filter Primary..... A-5509 Air Filter Set..... A-5549M-S Air Filter Primary..... A-5549M Air Filter Primary..... A-5549 Air Filter Set..... A-5522-S Air Filter Secondary..... A-5510 Fuel Filter..... F-5501 Fuel Filter Secondary..... FC-5507 Hydraulic Oil Filter..... H-5502 Hydraulic Oil Filter..... H-5508		14H (MOTOR GRADERS) S/N: 7WJ11-10 Fuel Filter Secondary..... FC-5507 Fuel Filter..... FC-5501 Hydraulic Oil Filter..... H-5506 Hydraulic Oil Filter..... H-5504 Oil Filter Full Flow..... C-5510	

Sakura Filter

ENGINE APPLICATION

MODEL/APPLICATION	SAKURA NO	MODEL/APPLICATION	SAKURA NO	MODEL/APPLICATION	SAKURA NO
CATERPILLAR		CATERPILLAR		CATERPILLAR	
14H (MOTOR GRADERS) w/3306 Eng. Air Filter Set..... A-5573M-S Air Filter Primary..... A-5535M		Hydraulic Oil Filter..... H-5502 Hydraulic Oil Filter..... H-5508 153 (HYDRAULIC SYSTEMS) S/N: 53G1-UP Hydraulic Oil Filter..... H-5508 Hydraulic Oil Filter..... H-5502		160H (MOTOR GRADERS) S/N: 9JM1-UP Air Filter Secondary..... A-5534 Air Filter Set..... A-5573-S Air Filter Primary..... A-5535 Fuel Filter Secondary..... FC-5507 Fuel Filter..... F-5505 Hydraulic Oil Filter..... H-5504 Hydraulic Oil Filter..... H-5506 Hydraulic Oil Filter..... H-55270 Oil Filter Full Flow..... C-5510	
14H NA (MOTOR GRADERS) Air Filter Set..... A-5573-S Air Filter Primary..... A-5535 Air Filter Secondary..... A-5534 Cabin Air Filter..... CA-5501 Fuel Filter..... F-5505 Fuel Filter Secondary..... FC-5507 Hydraulic Oil Filter..... H-5506 Hydraulic Oil Filter..... H-5504 Hydraulic Oil Filter..... H-55270 Oil Filter Full Flow..... C-5510		160H (MOTOR GRADERS) CAT 3306 (S/N: 2FM1-UP) Air Filter Primary..... A-5535 Air Filter Set..... A-5573-S Air Filter Secondary..... A-5534 Fuel Filter..... F-5505 Fuel Filter Secondary..... FC-5507 Hydraulic Oil Filter..... H-5506 Hydraulic Oil Filter..... H-55270 Oil Filter Full Flow..... C-5510		160H (MOTOR GRADERS) W/3176C ENG. Air Filter Primary..... A-5535M Air Filter Set..... A-5573M-S	
14H NA (MOTOR GRADERS) w/3306 Eng. Air Filter Primary..... A-5535M Air Filter Set..... A-5573M-S		160H (MOTOR GRADERS) CAT 3306 (S/N: 2HS1-UP) Air Filter Secondary..... A-5534 Air Filter Set..... A-5573-S Air Filter Primary..... A-5535 Fuel Filter Secondary..... FC-5507 Fuel Filter..... F-5505 Hydraulic Oil Filter..... H-55270 Hydraulic Oil Filter..... H-5506 Oil Filter Full Flow..... C-5510		160H (MOTOR GRADERS) W/3306 Eng. Air Filter Set..... A-5573M-S Air Filter Primary..... A-5535M	
14M (MOTOR GRADERS) CAT C11 , 2007-UP Fuel Filter..... FC-5517		160H (MOTOR GRADERS) CAT 3306 (S/N: 3GM1-UP) Air Filter Primary..... A-5535 Air Filter Set..... A-5573-S Air Filter Secondary..... A-5534 Fuel Filter..... F-5505 Fuel Filter Secondary..... FC-5507 Hydraulic Oil Filter..... H-5506 Hydraulic Oil Filter..... H-55270 Oil Filter Full Flow..... C-5510		160H ES (MOTOR GRADERS) Air Filter Primary..... A-5535 Air Filter Secondary..... A-5534 Air Filter Set..... A-5573-S Cabin Air Filter..... CA-5501 Fuel Filter Secondary..... FC-5507 Fuel Filter..... F-5505 Hydraulic Oil Filter..... H-55270 Hydraulic Oil Filter..... H-5504 Hydraulic Oil Filter..... H-5506 Oil Filter Full Flow..... C-5510	
14M (MOTOR GRADERS) C11 Cabin Air Filter..... CA-55110		160H (MOTOR GRADERS) CAT 3306 (S/N: 6MM1-UP) Air Filter Primary..... A-5535 Air Filter Set..... A-5573-S Air Filter Secondary..... A-5534 Fuel Filter..... F-5505 Fuel Filter Secondary..... FC-5507 Hydraulic Oil Filter..... H-5506 Hydraulic Oil Filter..... H-55270 Oil Filter Full Flow..... C-5510		160H ES (MOTOR GRADERS) W/3306 Eng. Air Filter Primary..... A-5535M Air Filter Set..... A-5573M-S	
14M (MOTOR GRADERS) CAT (S/N: RSX1-UP) Fuel Filter..... FC-5517		160H (MOTOR GRADERS) S/N: 9EJ1-UP Air Filter Primary..... A-5535 Air Filter Set..... A-5573-S Air Filter Secondary..... A-5534 Fuel Filter..... F-5505 Fuel Filter Secondary..... FC-5507 Hydraulic Oil Filter..... H-5506 Hydraulic Oil Filter..... H-55270 Oil Filter Full Flow..... C-5510		16 (MOTOR GRADERS) S/N: 49G1-UP Air Filter Secondary..... A-5510 Air Filter Set..... A-5522-S Air Filter Primary..... A-5509 Air Filter Set..... A-5549M-S Air Filter Secondary..... A-5550 Air Filter Primary..... A-5549 Air Filter Primary..... A-5549M Fuel Filter..... F-5501 Hydraulic Oil Filter..... H-5502 Hydraulic Oil Filter..... H-5508 Hydraulic Oil Filter..... H-5504 Oil Filter Full Flow..... O-5503 Oil Filter Full Flow..... O-5501	
14M (MOTOR GRADERS) S/N: B9J1-UP Air Filter Secondary..... A-8103 Hydraulic Oil Filter..... HC-5504		160H (MOTOR GRADERS) S/N: 62G1-UP Hydraulic Oil Filter..... H-5502 Hydraulic Oil Filter..... H-5508		160H ES (MOTOR GRADERS) W/3306 Eng. Air Filter Primary..... A-5535M Air Filter Set..... A-5573M-S	
151 (HYDRAULIC SYSTEMS) S/N: 62G1-UP Hydraulic Oil Filter..... H-5502 Hydraulic Oil Filter..... H-5508		160H (MOTOR GRADERS) S/N: 6MM1-UP Air Filter Secondary..... A-5534 Air Filter Set..... A-5573-S Air Filter Primary..... A-5535 Fuel Filter Secondary..... FC-5507 Fuel Filter..... F-5505 Hydraulic Oil Filter..... H-5504 Hydraulic Oil Filter..... H-5506 Hydraulic Oil Filter..... H-55270 Oil Filter Full Flow..... C-5510		16 (MOTOR GRADERS) S/N: 93U1-3459 Air Filter Set..... A-5573-S Air Filter Primary..... A-5501 Air Filter Secondary..... A-5502 Air Filter Primary..... A-5535 Air Filter Secondary..... A-5534 Fuel Filter..... FC-5509	
153 (HYDRAULIC SYSTEMS) S/N: 38G1-UP Hydraulic Oil Filter..... H-5502 Hydraulic Oil Filter..... H-5508		160H (MOTOR GRADERS) S/N: 9EJ1-UP Air Filter Primary..... A-5535 Air Filter Set..... A-5573-S Air Filter Secondary..... A-5534 Fuel Filter..... F-5505 Fuel Filter Secondary..... FC-5507 Hydraulic Oil Filter..... H-55270 Hydraulic Oil Filter..... H-5506 Hydraulic Oil Filter..... H-5504 Oil Filter Full Flow..... C-5510		16 (MOTOR GRADERS) S/N: 93U1-3459 Air Filter Set..... A-5573-S Air Filter Primary..... A-5501 Air Filter Secondary..... A-5502 Air Filter Primary..... A-5535 Air Filter Secondary..... A-5534 Fuel Filter..... FC-5509	
153 (HYDRAULIC SYSTEMS) S/N: 39G1-UP Hydraulic Oil Filter..... H-5508 Hydraulic Oil Filter..... H-5502		160H (MOTOR GRADERS) S/N: 9EJ1-UP Air Filter Primary..... A-5535 Air Filter Set..... A-5573-S Air Filter Secondary..... A-5534 Fuel Filter..... F-5505 Fuel Filter Secondary..... FC-5507 Hydraulic Oil Filter..... H-55270 Hydraulic Oil Filter..... H-5506 Hydraulic Oil Filter..... H-5504 Oil Filter Full Flow..... C-5510		16 (MOTOR GRADERS) S/N: 93U1-3459 Air Filter Set..... A-5573-S Air Filter Primary..... A-5501 Air Filter Secondary..... A-5502 Air Filter Primary..... A-5535 Air Filter Secondary..... A-5534 Fuel Filter..... FC-5509	
153 (HYDRAULIC SYSTEMS) S/N: 44G1-UP Hydraulic Oil Filter..... H-5502 Hydraulic Oil Filter..... H-5508		160H (MOTOR GRADERS) S/N: 9EJ1-UP Air Filter Primary..... A-5535 Air Filter Set..... A-5573-S Air Filter Secondary..... A-5534 Fuel Filter..... F-5505 Fuel Filter Secondary..... FC-5507 Hydraulic Oil Filter..... H-55270 Hydraulic Oil Filter..... H-5506 Hydraulic Oil Filter..... H-5504 Oil Filter Full Flow..... C-5510		16 (MOTOR GRADERS) S/N: 93U1-3459 Air Filter Set..... A-5573-S Air Filter Primary..... A-5501 Air Filter Secondary..... A-5502 Air Filter Primary..... A-5535 Air Filter Secondary..... A-5534 Fuel Filter..... FC-5509	
153 (HYDRAULIC SYSTEMS) S/N: 51F1-UP Hydraulic Oil Filter..... H-5508 Hydraulic Oil Filter..... H-5502		160H (MOTOR GRADERS) S/N: 52G1-UP			
153 (HYDRAULIC SYSTEMS) S/N: 52G1-UP					

Sakura Filter

ENGINE APPLICATION

MODEL/APPLICATION	SAKURA NO	MODEL/APPLICATION	SAKURA NO	MODEL/APPLICATION	SAKURA NO
CATERPILLAR		CATERPILLAR		CATERPILLAR	
16 (MOTOR GRADERS) S/N: 93U1-3459		1600 MOTOREN (ENGINES) (ENGINES) 1676		Hydraulic Oil Filter.....	H-5508
Fuel Filter.....	FC-5519	Fuel Filter.....	FC-6206	Hydraulic Oil Filter.....	H-5502
Hydraulic Oil Filter.....	H-5504	1600 MOTOREN (ENGINES) (ENGINES) 1693		163 (HYDRAULIC SYSTEMS) S/N: 41F1-41F234	
Oil Filter Full Flow.....	C-5516	Fuel Filter.....	FC-6206	Hydraulic Oil Filter.....	H-5504
160G (MOTOR GRADERS)		160H NA (MOTOR GRADERS) w/3306 Eng.		Hydraulic Oil Filter.....	H-5503
Air Filter Primary.....	A-5509	Air Filter Primary.....	A-5535M	Hydraulic Oil Filter.....	H-5504
Air Filter Set.....	A-5522-S	Air Filter Set.....	A-5573M-S	163 (HYDRAULIC SYSTEMS) S/N: 44G1-UP	
Air Filter Secondary.....	A-5522	161 (HYDRAULIC SYSTEMS) S/N: 48E1-48E4199		Hydraulic Oil Filter.....	H-5508
Fuel Filter.....	F-5505	Oil Filter Full Flow.....	O-5505	Hydraulic Oil Filter.....	H-5502
Fuel Filter.....	FC-5501	161 (HYDRAULIC SYSTEMS) S/N: 54G1-UP		163 (HYDRAULIC SYSTEMS) S/N: 51F1-UP	
Fuel Filter Secondary.....	FC-5507	Hydraulic Oil Filter.....	H-5502	Hydraulic Oil Filter.....	H-5502
Hydraulic Oil Filter.....	H-5504	Hydraulic Oil Filter.....	H-5508	Hydraulic Oil Filter.....	H-5508
Hydraulic Oil Filter.....	H-55270	161 (HYDRAULIC SYSTEMS) S/N: 62G7001-UP		Hydraulic Oil Filter.....	H-5502
Oil Filter Full Flow.....	C-5510	Hydraulic Oil Filter.....	H-5508	Hydraulic Oil Filter.....	H-5502
160G (MOTOR GRADERS) S/N: 43D1-140		161 (HYDRAULIC SYSTEMS) S/N: 62G7001-UP		163 (HYDRAULIC SYSTEMS) S/N: 52G1-UP	
Air Filter Primary.....	A-5509	Hydraulic Oil Filter.....	H-5508	Hydraulic Oil Filter.....	H-5508
Air Filter Secondary.....	A-5522	163H (MOTOR GRADERS) CAT 3176C ATAAC VHP		Hydraulic Oil Filter.....	H-5502
Air Filter Set.....	A-5522-S	Air Filter Secondary.....	A-5534	Hydraulic Oil Filter.....	H-5508
Fuel Filter Secondary.....	FC-5507	Air Filter Primary.....	A-5535	163 (HYDRAULIC SYSTEMS) S/N: 69F-69F	
Fuel Filter.....	F-5505	Air Filter Set.....	A-5573-S	Hydraulic Oil Filter.....	H-5504
Hydraulic Oil Filter.....	H-55270	Fuel Filter.....	F-5505	Hydraulic Oil Filter.....	H-5503
Hydraulic Oil Filter.....	H-5504	Fuel Filter Secondary.....	FC-5507	163 (HYDRAULIC SYSTEMS) S/N: 70E1-70E284	
Oil Filter Full Flow.....	C-5510	Hydraulic Oil Filter.....	H-5506	Hydraulic Oil Filter.....	H-5503
160G (MOTOR GRADERS) S/N: 43D141-UP		Hydraulic Oil Filter.....	H-5504	Hydraulic Oil Filter.....	H-5502
Air Filter Set.....	A-5522-S	Hydraulic Oil Filter.....	H-55270	Hydraulic Oil Filter.....	H-5504
Air Filter Secondary.....	A-5522	Hydraulic Oil Filter.....	HC-5504	163 (HYDRAULIC SYSTEMS) S/N: 7X1-UP	
Air Filter Primary.....	A-5509	Oil Filter Full Flow.....	C-5510	Hydraulic Oil Filter.....	H-5508
Fuel Filter.....	F-5505	163H (MOTOR GRADERS) w/3176C Eng.		Hydraulic Oil Filter.....	H-5502
Fuel Filter Secondary.....	FC-5507	Air Filter Set.....	A-5573M-S	163 (HYDRAULIC SYSTEMS) S/N: 8X1-UP	
Hydraulic Oil Filter.....	H-5504	Air Filter Primary.....	A-5535M	Hydraulic Oil Filter.....	H-5502
Hydraulic Oil Filter.....	H-55270	163H (MOTOR GRADERS) w/3306 Eng.		Hydraulic Oil Filter.....	H-5508
Oil Filter Full Flow.....	C-5510	Air Filter Primary.....	A-5535M	163 (HYDRAULIC SYSTEMS) S/N: 9X1-UP	
160M (MOTOR GRADERS) CAT S/N: B9L1-UP		Air Filter Set.....	A-5573M-S	Hydraulic Oil Filter.....	H-5502
Fuel Filter.....	FC-5517	163 (HYDRAULIC SYSTEMS) S/N: 38F1-38F3268		Hydraulic Oil Filter.....	H-5508
Hydraulic Oil Filter.....	HC-5504	Hydraulic Oil Filter.....	H-5504	Hydraulic Oil Filter.....	H-5502
160M (MOTOR GRADERS) CAT S/N: CZM1-UP		Hydraulic Oil Filter.....	H-5503	163 (HYDRAULIC SYSTEMS) S/N: 9X1-UP	
Fuel Filter.....	FC-5517	163 (HYDRAULIC SYSTEMS) S/N: 38G1-UP		Hydraulic Oil Filter.....	H-5508
Hydraulic Oil Filter.....	HC-5504	Hydraulic Oil Filter.....	H-5508	Hydraulic Oil Filter.....	H-5502
160M (MOTOR GRADERS) CAT S/N: THX1-UP		163 (HYDRAULIC SYSTEMS) S/N: 39F1-39F7849		163H NA (MOTOR GRADERS) S/N: 5AK1-UP	
Fuel Filter.....	FC-5517	Hydraulic Oil Filter.....	H-5503	Air Filter Primary.....	A-5535
Hydraulic Oil Filter.....	HC-5504	Hydraulic Oil Filter.....	H-5504	Air Filter Secondary.....	A-5534
1600 MOTOREN (ENGINES) (ENGINES) 1673		163 (HYDRAULIC SYSTEMS) S/N: 39G1-UP		Air Filter Set.....	A-5573-S
Fuel Filter.....	FC-6206	Hydraulic Oil Filter.....	H-5508	Fuel Filter.....	F-5505
1600 MOTOREN (ENGINES) (ENGINES) 1674		Hydraulic Oil Filter.....	H-5504	Fuel Filter Secondary.....	FC-5507
Fuel Filter.....	FC-6206	163 (HYDRAULIC SYSTEMS) S/N: 39G1-UP		Hydraulic Oil Filter.....	H-5506
		Hydraulic Oil Filter.....	H-5504	Hydraulic Oil Filter.....	H-5504
				Hydraulic Oil Filter.....	H-55270

MODEL/APPLICATION	SAKURA NO	MODEL/APPLICATION	SAKURA NO	MODEL/APPLICATION	SAKURA NO
CATERPILLAR		CATERPILLAR		CATERPILLAR	
163H NA (MOTOR GRADERS) S/N: 5AK1-UP		16G (MOTOR GRADERS) S/N: 93U3460-UP		Fuel Filter.....	FC-5517
Hydraulic Oil Filter.....	HC-5504	Air Filter Set.....	A-5573-S	Fuel Filter.....	FC-5510
Oil Filter Full Flow.....	C-5510	Air Filter Secondary.....	A-5502	Hydraulic Oil Filter.....	HC-5504
165 (HYDRAULIC SYSTEMS) S/N: 38F1-38F3268		Air Filter Primary.....	A-5501	16M (MOTOR GRADERS) C13	
Hydraulic Oil Filter.....	H-5504	Air Filter Primary.....	A-5535	Cabin Air Filter.....	CA-55110
Hydraulic Oil Filter.....	H-5503	Air Filter Secondary.....	A-5534	16M (MOTOR GRADERS) CAT S/N: B9H1-UP	
165 (HYDRAULIC SYSTEMS) S/N: 39F1-39F7840		Fuel Filter.....	FC-5509	Air Filter Secondary.....	A-8103
Hydraulic Oil Filter.....	H-5503	Hydraulic Oil Filter.....	H-55270	Fuel Filter.....	FC-5517
Hydraulic Oil Filter.....	H-5504	Hydraulic Oil Filter.....	H-5504	Fuel Filter.....	FC-5510
165 (HYDRAULIC SYSTEMS) S/N: 41F1-41F234		Oil Filter Full Flow.....	C-5516	Hydraulic Oil Filter.....	HC-5504
Hydraulic Oil Filter.....	H-5504	16G (MOTOR GRADERS) w/3406 Eng.		16M (MOTOR GRADERS) CAT S/N: MHX1-UP	
Hydraulic Oil Filter.....	H-5503	Air Filter Primary.....	A-5535M	Air Filter Secondary.....	A-8103
Hydraulic Oil Filter.....	H-5503	Air Filter Set.....	A-5573M-S	Fuel Filter.....	FC-5517
165 (HYDRAULIC SYSTEMS) S/N: 42F1-42F504		16H (MOTOR GRADERS) W/3196 ENG.		Fuel Filter.....	FC-5510
Hydraulic Oil Filter.....	H-5503	Air Filter Primary.....	A-5535M	Hydraulic Oil Filter.....	HC-5504
Hydraulic Oil Filter.....	H-5504	Air Filter Set.....	A-5573M-S	172 (HYDRAULIC SYSTEMS) S/N: 24G1-24G252	
165 (HYDRAULIC SYSTEMS) S/N: 69F-69F		16H (MOTOR GRADERS) W/3406C ENG.		Hydraulic Oil Filter.....	H-5502
Hydraulic Oil Filter.....	H-5504	Air Filter Set.....	A-5573M-S	Hydraulic Oil Filter.....	H-5508
Hydraulic Oil Filter.....	H-5503	Air Filter Primary.....	A-5535M	172 (HYDRAULIC SYSTEMS) S/N: 25G1-25G140	
165 (HYDRAULIC SYSTEMS) S/N: 70E1-70E284		16HNA (MOTOR GRADERS)		Hydraulic Oil Filter.....	H-5508
Hydraulic Oil Filter.....	H-5503	Air Filter Primary.....	A-5535	Hydraulic Oil Filter.....	H-5502
Hydraulic Oil Filter.....	H-5504	Air Filter Secondary.....	A-5534	172 (HYDRAULIC SYSTEMS) S/N: 48C1-UP	
16G (MOTOR GRADERS) S/N: 59M1-UP		Air Filter Set.....	A-5573-S	Hydraulic Oil Filter.....	H-5502
Air Filter Secondary.....	A-5502	Cabin Air Filter.....	CA-5501	Hydraulic Oil Filter.....	H-5508
16G (MOTOR GRADERS) S/N: 93U1869-2510		Fuel Filter.....	FC-5509	172 (HYDRAULIC SYSTEMS) S/N: 65G1-65G2567	
Air Filter Primary.....	A-5501	Fuel Filter.....	F-5505	Hydraulic Oil Filter.....	H-5508
16G (MOTOR GRADERS) S/N: 93U1-UP		Hydraulic Oil Filter.....	H-55270	Hydraulic Oil Filter.....	H-5502
Air Filter Primary.....	A-5501	Hydraulic Oil Filter.....	H-5506	172 (HYDRAULIC SYSTEMS) S/N: 67G1-UP	
Air Filter Secondary.....	A-5502	Hydraulic Oil Filter.....	H-5504	Hydraulic Oil Filter.....	H-5502
Fuel Filter.....	FC-5519	16HNA (MOTOR GRADERS) S/N: 62J1-UP		Hydraulic Oil Filter.....	H-5508
Hydraulic Oil Filter.....	H-5502	Air Filter Set.....	A-5573-S	173 (HYDRAULIC SYSTEMS) S/N: 24G1-24G252	
Hydraulic Oil Filter.....	H-5504	Air Filter Secondary.....	A-5534	Hydraulic Oil Filter.....	H-5502
Hydraulic Oil Filter.....	H-5508	Air Filter Primary.....	A-5535	Hydraulic Oil Filter.....	H-5508
Oil Filter Full Flow.....	C-5516	Fuel Filter.....	FC-5509	173 (HYDRAULIC SYSTEMS) S/N: 25G1-25G140	
16G (MOTOR GRADERS) S/N: 93U2511-2661		Fuel Filter.....	F-5505	Hydraulic Oil Filter.....	H-5508
Air Filter Secondary.....	A-5502	Hydraulic Oil Filter.....	H-5504	Hydraulic Oil Filter.....	H-5502
Air Filter Primary.....	A-5501	Hydraulic Oil Filter.....	H-5506	173 (HYDRAULIC SYSTEMS) S/N: 48C1-UP	
Hydraulic Oil Filter.....	H-55270	Hydraulic Oil Filter.....	H-55270	Hydraulic Oil Filter.....	H-5502
Hydraulic Oil Filter.....	H-5504	16HNA (MOTOR GRADERS) S/N: 62J1-UP		Hydraulic Oil Filter.....	H-5508
16G (MOTOR GRADERS) S/N: 93U2662-3459		Air Filter Primary.....	A-5535M	173 (HYDRAULIC SYSTEMS) S/N: 65G1-65G2567	
Air Filter Primary.....	A-5501	Air Filter Set.....	A-5573M-S	Hydraulic Oil Filter.....	H-5508
Air Filter Secondary.....	A-5502	16M (MOTOR GRADERS) CAT S/N: B9H1-UP , 2007-UP		Hydraulic Oil Filter.....	H-5502
Hydraulic Oil Filter.....	H-5504	Air Filter Secondary.....	A-8103	Hydraulic Oil Filter.....	H-5508
Hydraulic Oil Filter.....	H-55270	Fuel Filter.....	FC-5517	173 (HYDRAULIC SYSTEMS) S/N: 67G1-UP	
16G (MOTOR GRADERS) S/N: 93U2662-3459		Fuel Filter.....	FC-5510	173 (HYDRAULIC SYSTEMS) S/N: 25G1-25G140	
Air Filter Primary.....	A-5501	Hydraulic Oil Filter.....	HC-5504	Hydraulic Oil Filter.....	H-5508
Air Filter Secondary.....	A-5502	16M (MOTOR GRADERS) CAT S/N: MHX1-UP , 2007-UP		Hydraulic Oil Filter.....	H-5502
Hydraulic Oil Filter.....	H-5504	Air Filter Secondary.....	A-8103		
Hydraulic Oil Filter.....	H-55270				

MODEL/APPLICATION	SAKURA NO	MODEL/APPLICATION	SAKURA NO	MODEL/APPLICATION	SAKURA NO
CATERPILLAR		CATERPILLAR		CATERPILLAR	
173 (HYDRAULIC SYSTEMS) S/N: 67G1-UP Hydraulic Oil Filter..... H-5502 Hydraulic Oil Filter..... H-5508		183B (HYDRAULIC SYSTEMS) S/N: 28A1-UP Hydraulic Oil Filter..... H-5506		193 (HYDRAULIC SYSTEMS) S/N: 28H1-UP Hydraulic Oil Filter..... H-5503	
173B (HYDRAULIC SYSTEMS) S/N: 28A1-UP Hydraulic Oil Filter..... H-5506		183B (HYDRAULIC SYSTEMS) S/N: 34H1-UP Hydraulic Oil Filter..... H-5503		193 (HYDRAULIC SYSTEMS) S/N: 37E1-37E409 Hydraulic Oil Filter..... H-5503	
173B (HYDRAULIC SYSTEMS) S/N: 41V1-UP Hydraulic Oil Filter..... H-5506		183B (HYDRAULIC SYSTEMS) S/N: 35H1-UP Hydraulic Oil Filter..... H-5503		193 (HYDRAULIC SYSTEMS) S/N: 91F1-91F2566 Hydraulic Oil Filter..... H-5503	
173B (HYDRAULIC SYSTEMS) S/N: 59P1-UP Hydraulic Oil Filter..... H-5503		183B (HYDRAULIC SYSTEMS) S/N: 41V1-UP Hydraulic Oil Filter..... H-5506		193B (HYDRAULIC SYSTEMS) S/N: 27H1-UP Hydraulic Oil Filter..... H-5503	
173B (HYDRAULIC SYSTEMS) S/N: 60P1-UP Hydraulic Oil Filter..... H-5503		183B (HYDRAULIC SYSTEMS) S/N: 59P1-UP Hydraulic Oil Filter..... H-5503		193B (HYDRAULIC SYSTEMS) S/N: 28A1-UP Hydraulic Oil Filter..... H-5506	
176 (HYDRAULIC SYSTEMS) S/N: 36E1-36E8992 Hydraulic Oil Filter..... H-5504		183B (HYDRAULIC SYSTEMS) S/N: 60P1-UP Hydraulic Oil Filter..... H-5503		193B (HYDRAULIC SYSTEMS) S/N: 28H1-UP Hydraulic Oil Filter..... H-5503	
182 (HYDRAULIC SYSTEMS) S/N: 38F1-38F3268 Hydraulic Oil Filter..... H-5504 Hydraulic Oil Filter..... H-5503		184 (HYDRAULIC SYSTEMS) S/N: 37E1-37E409 Hydraulic Oil Filter..... H-5503		193B (HYDRAULIC SYSTEMS) S/N: 41V1-UP Hydraulic Oil Filter..... H-5506	
182 (HYDRAULIC SYSTEMS) S/N: 39F1-39F7849 Hydraulic Oil Filter..... H-5503 Hydraulic Oil Filter..... H-5504		184 (HYDRAULIC SYSTEMS) S/N: 91F1-91F2566 Hydraulic Oil Filter..... H-5503		193B (HYDRAULIC SYSTEMS) S/N: 42V1-UP Hydraulic Oil Filter..... H-5506	
182 (HYDRAULIC SYSTEMS) S/N: 41F1-41F234 Hydraulic Oil Filter..... H-5504 Hydraulic Oil Filter..... H-5503		191 (HYDRAULIC SYSTEMS) S/N: 48E1-48E4199 Oil Filter Full Flow..... O-5505		205 (EXCAVATORS) PERKINS 4.236 (S/N: 4DC1-UP) Fuel Filter..... FC-5704	
182 (HYDRAULIC SYSTEMS) S/N: 42F1-42F504 Hydraulic Oil Filter..... H-5503 Hydraulic Oil Filter..... H-5504		192 (HYDRAULIC SYSTEMS) S/N: 38F1-38F3268 Hydraulic Oil Filter..... H-5503 Hydraulic Oil Filter..... H-5504		205 (EXCAVATORS) S/N: 3HC1-UP Air Filter Secondary..... A-7964 Air Filter Set..... AS-5656-S Air Filter Primary..... AS-7805 Fuel Filter..... FC-5103 Fuel Filter..... FC-5704 Oil Filter Full Flow..... C-5101 Oil Filter Full Flow..... C-6202	
182 (HYDRAULIC SYSTEMS) S/N: 70E1-70E284 Hydraulic Oil Filter..... H-5504 Hydraulic Oil Filter..... H-5503		192 (HYDRAULIC SYSTEMS) S/N: 41F1-41F234 Hydraulic Oil Filter..... H-5503 Hydraulic Oil Filter..... H-5504		205 (EXCAVATORS) S/N: 4DC1-UP Air Filter Primary..... AS-7805 Air Filter Set..... AS-5656-S Air Filter Secondary..... A-7964 Fuel Filter..... FC-5704 Fuel Filter..... FC-5103 Oil Filter Full Flow..... C-5101 Oil Filter Full Flow..... C-6202	
183 (HYDRAULIC SYSTEMS) S/N: 27H1-UP Hydraulic Oil Filter..... H-5503		192 (HYDRAULIC SYSTEMS) S/N: 42F1-42F504 Hydraulic Oil Filter..... H-5504 Hydraulic Oil Filter..... H-5503		205B (EXCAVATORS) CAT 3114 (S/N: 5ZF1-UP) Fuel Filter..... F-5505 Fuel Filter Secondary..... FC-5507 Oil Filter Full Flow..... C-5505	
183 (HYDRAULIC SYSTEMS) S/N: 28H1-UP Hydraulic Oil Filter..... H-5503		192 (HYDRAULIC SYSTEMS) S/N: 62F-62F Hydraulic Oil Filter..... H-5503 Hydraulic Oil Filter..... H-5504		206 (EXCAVATORS) PERKINS 4.236 (S/N: 3GC1-UP) Fuel Filter..... FC-5704	
183 (HYDRAULIC SYSTEMS) S/N: 36E1-UP Hydraulic Oil Filter..... H-5504		193 (HYDRAULIC SYSTEMS) S/N: 70E1-70E284 Hydraulic Oil Filter..... H-5504 Hydraulic Oil Filter..... H-5503		206 (EXCAVATORS) S/N: 2RC1-UP	
183 (HYDRAULIC SYSTEMS) S/N: 59P1-UP Hydraulic Oil Filter..... H-5503		193 (HYDRAULIC SYSTEMS) S/N: 27H1-UP Hydraulic Oil Filter..... H-5503			
183 (HYDRAULIC SYSTEMS) S/N: 60P1-UP Hydraulic Oil Filter..... H-5503					

MODEL/APPLICATION	SAKURA NO
CATERPILLAR	
206 (EXCAVATORS) S/N: 2RC1-UP	
Air Filter Primary.....	AS-7805
Air Filter Set.....	AS-5656-S
Air Filter Secondary.....	A-7964
Fuel Filter.....	FC-5103
Fuel Filter.....	FC-5704
Oil Filter Full Flow.....	C-5101
Oil Filter Full Flow.....	C-6202
206 (EXCAVATORS) S/N: 3GC1-UP	
Air Filter Secondary.....	A-7964
Air Filter Set.....	AS-5656-S
Air Filter Primary.....	AS-7805
Fuel Filter.....	FC-5103
Fuel Filter.....	FC-5704
Oil Filter Full Flow.....	C-6202
Oil Filter Full Flow.....	C-5101
206B (EXCAVATORS) PERKINS 4.236 (S/N: 9BF1-UP)	
Air Filter Primary.....	AS-5523
Air Filter Secondary.....	A-7913
Fuel Filter.....	F-5505
Fuel Filter Secondary.....	FC-5507
Oil Filter Full Flow.....	C-5505
211 (EXCAVATORS) S/N: 4EC1-UP	
Air Filter Set.....	AS-5656-S
Air Filter Primary.....	AS-7805
Air Filter Secondary.....	A-7964
Fuel Filter.....	FC-5103
Fuel Filter.....	FC-5704
Oil Filter Full Flow.....	C-5101
211 (EXCAVATORS) S/N: 5CC1-UP	
Air Filter Secondary.....	A-7964
Air Filter Primary.....	AS-7805
Air Filter Set.....	AS-5656-S
Fuel Filter.....	FC-5704
Fuel Filter.....	FC-5103
Oil Filter Full Flow.....	C-5101
211 (EXCAVATORS) S/N: 5DC1-UP	
Air Filter Set.....	AS-5656-S
Air Filter Primary.....	AS-7805
Air Filter Secondary.....	A-7964
Fuel Filter.....	FC-5103
Fuel Filter.....	FC-5704
Oil Filter Full Flow.....	C-5101
212 (EXCAVATORS) PERKINS 4.236 (S/N: 5DC1-UP)	
Fuel Filter.....	FC-5704
212 (EXCAVATORS) S/N: 3JC1-UP	
Air Filter Secondary.....	A-7964
Air Filter Primary.....	AS-7805
Air Filter Set.....	AS-5656-S
Fuel Filter.....	FC-5704

MODEL/APPLICATION	SAKURA NO
CATERPILLAR	
Fuel Filter.....	FC-5103
Oil Filter Full Flow.....	C-6202
212 (EXCAVATORS) S/N: 5DC1-UP	
Air Filter Set.....	AS-5656-S
Air Filter Primary.....	AS-7805
Air Filter Secondary.....	A-7964
Fuel Filter.....	FC-5103
Fuel Filter.....	FC-5704
Oil Filter Full Flow.....	C-6202
213 (EXCAVATORS) S/N: 3ZC1-UP	
Air Filter Secondary.....	A-7913
Fuel Filter.....	FC-5704
Fuel Filter.....	FC-5103
Oil Filter Full Flow.....	C-5102
Oil Filter Full Flow.....	C-6204
213 (EXCAVATORS) S/N: 9XB1-UP	
Air Filter Secondary.....	A-7913
Fuel Filter.....	FC-5103
Fuel Filter.....	FC-5704
Oil Filter Full Flow.....	C-6204
Oil Filter Full Flow.....	C-5102
213B (EXCAVATORS) CAT 3116 (S/N: 1EF1-UP)	
Air Filter Secondary.....	A-7913
Air Filter Primary.....	AS-5523
Fuel Filter Secondary.....	FC-5507
Oil Filter Full Flow.....	C-5510
213B (EXCAVATORS) CAT 3116 (S/N: 1EJ1-UP)	
Air Filter Primary.....	AS-5523
Air Filter Secondary.....	A-7913
Fuel Filter Secondary.....	FC-5507
Fuel Filter.....	F-5505
Oil Filter Full Flow.....	C-5510
214 (EXCAVATORS) S/N: 1KB1-UP	
Air Filter Secondary.....	A-7913
Fuel Filter.....	FC-5103
Fuel Filter.....	FC-5704
Oil Filter Full Flow.....	C-6204
Oil Filter Full Flow.....	C-5102
214 (EXCAVATORS) S/N: 9MB1-UP	
Air Filter Secondary.....	A-7913
Fuel Filter.....	FC-5704
Fuel Filter.....	FC-5103
Oil Filter Full Flow.....	C-5102
Oil Filter Full Flow.....	C-6204
214B (EXCAVATORS) CAT 3116 (S/N: 4CF1-UP)	
Air Filter Secondary.....	A-7913
Air Filter Secondary.....	A-6009
Air Filter Primary.....	AS-5523
Air Filter Primary.....	A-9226

MODEL/APPLICATION	SAKURA NO
CATERPILLAR	
Fuel Filter.....	F-5505
Fuel Filter Secondary.....	FC-5507
Oil Filter Full Flow.....	C-5510
214B (EXCAVATORS) CAT 3116 (S/N: 9MF1-UP)	
Air Filter Primary.....	A-9226
Air Filter Primary.....	AS-5523
Air Filter Secondary.....	A-6009
Fuel Filter Secondary.....	FC-5507
Fuel Filter.....	F-5505
Oil Filter Full Flow.....	C-5510
214B FT (EXCAVATORS) CAT 3116 (S/N: 4CF1-UP)	
Air Filter Primary.....	A-9226
Air Filter Primary.....	AS-5523
Air Filter Secondary.....	A-6009
Air Filter Secondary.....	A-7913
Fuel Filter.....	F-5505
Fuel Filter Secondary.....	FC-5507
Oil Filter Full Flow.....	C-5510
214B FT (EXCAVATORS) CAT 3116 (S/N: 9MF1-UP)	
Air Filter Secondary.....	A-7913
Air Filter Secondary.....	A-6009
Air Filter Primary.....	AS-5523
Air Filter Primary.....	A-9226
Fuel Filter Secondary.....	FC-5507
Fuel Filter.....	F-5505
Oil Filter Full Flow.....	C-5510
215 (EXCAVATORS) CAT 3402 (S/N: 14Z1-UP)	
Air Filter Primary.....	A-5507
Air Filter Set.....	A-5507-S
Air Filter Set.....	A-55071-S
Air Filter Secondary.....	A-5508
Fuel Filter.....	F-5505
Fuel Filter Secondary.....	FC-5507
Hydraulic Oil Filter.....	H-5502
Hydraulic Oil Filter.....	H-5508
Hydraulic Oil Filter.....	H-5503
Oil Filter Full Flow.....	C-5505
215 (EXCAVATORS) CAT 3402 (S/N: 57Y1-UP)	
Air Filter Secondary.....	A-5508
Air Filter Set.....	A-55071-S
Air Filter Set.....	A-5507-S
Air Filter Primary.....	A-5507
Fuel Filter.....	F-5505
Fuel Filter Secondary.....	FC-5507
Hydraulic Oil Filter.....	H-5503
Hydraulic Oil Filter.....	H-5508
Hydraulic Oil Filter.....	H-5502
Oil Filter Full Flow.....	C-5505
215 (EXCAVATORS) CAT 3402 (S/N: 61Z1-UP)	
Air Filter Primary.....	A-5507
Air Filter Set.....	A-5507-S
Air Filter Set.....	A-55071-S
Air Filter Secondary.....	A-5508

MODEL/APPLICATION	SAKURA NO	MODEL/APPLICATION	SAKURA NO	MODEL/APPLICATION	SAKURA NO
CATERPILLAR		CATERPILLAR		CATERPILLAR	
215 (EXCAVATORS) CAT 3402 (S/N: 61Z1-UP)		215B (EXCAVATORS) CAT 3204 (S/N: 2XC1-UP)		Oil Filter Full Flow.....	C-5510
Fuel Filter.....	F-5505	Air Filter Set.....	A-5507-S	215C (EXCAVATORS) S/N: 44G1-UP	
Fuel Filter Secondary.....	FC-5507	Air Filter Primary.....	A-5507	Air Filter Secondary.....	A-5510
Hydraulic Oil Filter.....	H-5502	Air Filter Secondary.....	A-5508	Air Filter Primary.....	A-5509
Hydraulic Oil Filter.....	H-5508	Air Filter Set.....	A-55071-S	Air Filter Set.....	A-5522-S
Hydraulic Oil Filter.....	H-5503	Fuel Filter Secondary.....	FC-5507	Fuel Filter.....	FC-5501
Oil Filter Full Flow.....	C-5505	Fuel Filter.....	F-5505	Hydraulic Oil Filter.....	H-5503
215 (EXCAVATORS) CAT 3402 (S/N: 95Z1-UP)		Hydraulic Oil Filter.....	H-5503	Oil Filter Full Flow.....	C-5510
Air Filter Secondary.....	A-5510	Hydraulic Oil Filter.....	H-5508	215D (EXCAVATORS) CAT 3304	
Air Filter Primary.....	A-5509	Hydraulic Oil Filter.....	H-5502	Hydraulic Oil Filter.....	HC-55112
Air Filter Set.....	A-5522-S	Oil Filter Full Flow.....	C-5505	215D (EXCAVATORS) CAT 3304 (S/N: 9TF1-UP)	
Fuel Filter.....	F-5505	215B (EXCAVATORS) CAT 3204 (S/N: 9YB1-UP)		Air Filter Set.....	A-5522-S
Fuel Filter Secondary.....	FC-5507	Air Filter Secondary.....	A-5510	Air Filter Secondary.....	A-5510
Hydraulic Oil Filter.....	H-5503	Air Filter Set.....	A-5522-S	Air Filter Primary.....	A-5509
Hydraulic Oil Filter.....	H-5508	Air Filter Primary.....	A-5509	Fuel Filter.....	F-5505
Hydraulic Oil Filter.....	H-5502	Fuel Filter.....	F-5505	Fuel Filter Secondary.....	FC-5507
Oil Filter Full Flow.....	C-5510	Fuel Filter Secondary.....	FC-5507	Hydraulic Oil Filter.....	H-5502
215 (EXCAVATORS) CAT 3402		Hydraulic Oil Filter.....	H-5502	Hydraulic Oil Filter.....	H-5508
Hydraulic Oil Filter.....	HC-55112	Hydraulic Oil Filter.....	H-5508	Hydraulic Oil Filter.....	H-5503
215 (EXCAVATORS) S/N: 4FC1-UP		Hydraulic Oil Filter.....	H-5503	Oil Filter Full Flow.....	C-5510
Air Filter Set.....	A-5522-S	Oil Filter Full Flow.....	C-5510	216 (LOADERS) S/N: 4NZ1-UP	
Air Filter Primary.....	A-5509	215B SA (EXCAVATORS) CAT 3204 (S/N: 4FC1-UP)		Air Filter Secondary.....	A-8599
Air Filter Secondary.....	A-5510	Air Filter Set.....	A-5522-S	Air Filter Primary.....	A-8505
Hydraulic Oil Filter.....	H-5502	Air Filter Secondary.....	A-5510	Hydraulic Oil Filter.....	HC-5504
Hydraulic Oil Filter.....	H-5508	Air Filter Primary.....	A-5509	Oil Filter Full Flow.....	C-5101
Hydraulic Oil Filter.....	H-5503	Fuel Filter.....	F-5505	216 (LOADERS) S/N: 5FZ1-UP	
Oil Filter Full Flow.....	C-5510	Fuel Filter Secondary.....	FC-5507	Air Filter Primary.....	A-8505
215 (EXCAVATORS) S/N: 96L1-UP		Hydraulic Oil Filter.....	H-5502	Air Filter Secondary.....	A-8599
Air Filter Secondary.....	A-5508	Hydraulic Oil Filter.....	H-5508	Hydraulic Oil Filter.....	HC-5504
Air Filter Set.....	A-5568-S	Hydraulic Oil Filter.....	H-5503	Oil Filter Full Flow.....	C-5101
Air Filter Primary.....	A-5566	Hydraulic Oil Filter.....	H-5503	216 (LOADERS) S/N: 6BZ1-699	
Air Filter Secondary.....	A-5567	Hydraulic Oil Filter.....	H-5502	Air Filter Secondary.....	A-8599
Air Filter Set.....	A-55071-S	Hydraulic Oil Filter.....	H-5502	Air Filter Primary.....	A-8505
Air Filter Set.....	A-5507-S	Oil Filter Full Flow.....	C-5510	Hydraulic Oil Filter.....	HC-5504
Air Filter Primary.....	A-5507	215C (EXCAVATORS) CAT 3304		Oil Filter Full Flow.....	C-5101
Fuel Filter Secondary.....	FC-5507	Hydraulic Oil Filter.....	HC-55112	216 (LOADERS) S/N: 6BZ1-699	
Hydraulic Oil Filter.....	H-5503	215C (EXCAVATORS) CAT 3304 (S/N: 4HG1-UP)		Air Filter Secondary.....	A-8599
Hydraulic Oil Filter.....	H-5508	Air Filter Secondary.....	A-5510	Air Filter Primary.....	A-8505
Hydraulic Oil Filter.....	H-5502	Air Filter Primary.....	A-5509	Hydraulic Oil Filter.....	HC-5504
Oil Filter Full Flow.....	C-5510	Air Filter Set.....	A-5522-S	Oil Filter Full Flow.....	C-5101
215 (EXCAVATORS) S/N: 9YB1-UP		Fuel Filter.....	F-5505	216B (LOADERS) CAT 3024C (S/N: RLL1-UP) , 2004-UP	
Air Filter Set.....	A-5522-S	Fuel Filter Secondary.....	FC-5507	Air Filter Primary.....	A-7003
Air Filter Secondary.....	A-5510	Hydraulic Oil Filter.....	H-5503	Air Filter Secondary.....	A-7004
Air Filter Primary.....	A-5509	Hydraulic Oil Filter.....	H-5508	Hydraulic Oil Filter.....	HC-5504
Hydraulic Oil Filter.....	H-5502	Hydraulic Oil Filter.....	H-5502	Oil Filter Full Flow.....	C-1123
Hydraulic Oil Filter.....	H-5508	Hydraulic Oil Filter.....	H-5502	216B (LOADERS) CAT 3034 (S/N: RLL1-UP) , 2004-UP	
Hydraulic Oil Filter.....	H-5503	Oil Filter Full Flow.....	C-5510	Air Filter Primary.....	A-7003
Oil Filter Full Flow.....	C-5510	215C (EXCAVATORS) CAT 3304 (S/N: 5CF1-UP)		Air Filter Secondary.....	A-7004
215B (EXCAVATORS) CAT 3304		Air Filter Set.....	A-5522-S	Hydraulic Oil Filter.....	HC-5504
Hydraulic Oil Filter.....	HC-55112	Air Filter Primary.....	A-5509	Oil Filter Full Flow.....	C-1123
		Air Filter Secondary.....	A-5510	219 (EXCAVATORS) CAT 3304	
		Fuel Filter Secondary.....	FC-5507	Hydraulic Oil Filter.....	HC-55112
		Fuel Filter.....	F-5505		
		Hydraulic Oil Filter.....	H-5502		
		Hydraulic Oil Filter.....	H-5508		
		Hydraulic Oil Filter.....	H-5503		

MODEL/APPLICATION	SAKURA NO
CATERPILLAR	
219 (EXCAVATORS) CAT 3304 (S/N: 4HG1-UP)	
Air Filter Primary.....	A-5509
Air Filter Secondary.....	A-5510
Air Filter Set.....	A-5522-S
Fuel Filter.....	F-5505
Fuel Filter Secondary.....	FC-5507
Hydraulic Oil Filter.....	H-5503
Hydraulic Oil Filter.....	H-5502
Hydraulic Oil Filter.....	H-5508
Oil Filter Full Flow.....	C-5510
219 (EXCAVATORS) CAT 3304 (S/N: 5CF1-UP)	
Air Filter Set.....	A-5522-S
Air Filter Secondary.....	A-5510
Air Filter Primary.....	A-5509
Fuel Filter.....	F-5505
Fuel Filter Secondary.....	FC-5507
Hydraulic Oil Filter.....	H-5502
Hydraulic Oil Filter.....	H-5503
Hydraulic Oil Filter.....	H-5508
Oil Filter Full Flow.....	C-5510
219D (EXCAVATORS) CAT 3304	
Hydraulic Oil Filter.....	HC-55112
219D (EXCAVATORS) CAT 3304 (S/N: 5XG00982-UP)	
Air Filter Set.....	A-5522-S
Air Filter Secondary.....	A-5510
Air Filter Primary.....	A-5509
Fuel Filter Secondary.....	FC-5507
Hydraulic Oil Filter.....	H-5502
Hydraulic Oil Filter.....	H-5508
Hydraulic Oil Filter.....	H-5503
Oil Filter Full Flow.....	C-5510
219D (EXCAVATORS) CAT 3304 (S/N: 5XG1-UP)	
Air Filter Primary.....	A-5509
Air Filter Secondary.....	A-5510
Air Filter Set.....	A-5522-S
Fuel Filter Secondary.....	FC-5507
Hydraulic Oil Filter.....	H-5503
Hydraulic Oil Filter.....	H-5508
Hydraulic Oil Filter.....	H-5502
Oil Filter Full Flow.....	C-5510
224 (EXCAVATORS) S/N: 23C1-UP	
Air Filter Secondary.....	A-6009
Air Filter Primary.....	A-9226
Fuel Filter.....	FC-5704
Oil Filter Full Flow.....	C-7911
224 (EXCAVATORS) S/N: 5TC1-UP	
Air Filter Secondary.....	A-7913
Fuel Filter.....	FC-5103
Oil Filter Full Flow.....	C-5101

MODEL/APPLICATION	SAKURA NO
CATERPILLAR	
224B (EXCAVATORS) CAT 3116 (S/N: 7WF1-UP)	
Air Filter Primary.....	AS-5523
Fuel Filter.....	F-5505
Fuel Filter Secondary.....	FC-5507
Oil Filter Full Flow.....	C-5510
225 (EXCAVATORS) S/N: 20S1-UP	
Air Filter Primary.....	A-5509
Air Filter Secondary.....	A-5510
Air Filter Set.....	A-5522-S
Air Filter Secondary.....	A-5550
Air Filter Set.....	A-5549M-S
Air Filter Primary.....	A-5549M
Air Filter Primary.....	A-5549
Fuel Filter Secondary.....	FC-5507
Hydraulic Oil Filter.....	H-5502
Hydraulic Oil Filter.....	H-5508
Oil Filter Full Flow.....	C-5510
Oil Filter Full Flow.....	C-5504
225 (EXCAVATORS) S/N: 51U1-589	
Air Filter Primary.....	A-5549
Air Filter Primary.....	A-5549M
Air Filter Set.....	A-5549M-S
Air Filter Secondary.....	A-5550
Air Filter Set.....	A-5522-S
Air Filter Secondary.....	A-5510
Air Filter Primary.....	A-5509
Fuel Filter.....	FC-5503
Hydraulic Oil Filter.....	H-5504
Hydraulic Oil Filter.....	H-5502
Hydraulic Oil Filter.....	H-5508
Hydraulic Oil Filter.....	H-5509
Oil Filter Full Flow.....	C-5504
225 (EXCAVATORS) S/N: 51U2832-UP	
Air Filter Primary.....	A-5509
Air Filter Secondary.....	A-5510
Air Filter Set.....	A-5522-S
Air Filter Secondary.....	A-5550
Air Filter Set.....	A-5549M-S
Air Filter Primary.....	A-5549M
Air Filter Primary.....	A-5549
Fuel Filter Secondary.....	FC-5507
Hydraulic Oil Filter.....	H-5502
Hydraulic Oil Filter.....	H-5504
Hydraulic Oil Filter.....	H-5509
Hydraulic Oil Filter.....	H-5508
Oil Filter Full Flow.....	C-5519
225 (EXCAVATORS) S/N: 51U590-2831	
Air Filter Primary.....	A-5549
Air Filter Primary.....	A-5549M
Air Filter Set.....	A-5549M-S
Air Filter Secondary.....	A-5550
Air Filter Set.....	A-5522-S
Air Filter Secondary.....	A-5510
Air Filter Primary.....	A-5509

MODEL/APPLICATION	SAKURA NO
CATERPILLAR	
Fuel Filter Secondary.....	FC-5507
Hydraulic Oil Filter.....	H-5504
Hydraulic Oil Filter.....	H-5502
Hydraulic Oil Filter.....	H-5508
Hydraulic Oil Filter.....	H-5509
Oil Filter Full Flow.....	C-5504
225 (EXCAVATORS) S/N: 61X1-UP	
Air Filter Primary.....	A-5509
Air Filter Secondary.....	A-5510
Air Filter Set.....	A-5522-S
Air Filter Secondary.....	A-5550
Air Filter Set.....	A-5549M-S
Air Filter Primary.....	A-5549M
Air Filter Primary.....	A-5549
Fuel Filter Secondary.....	FC-5507
Hydraulic Oil Filter.....	H-5502
Hydraulic Oil Filter.....	H-5508
Oil Filter Full Flow.....	C-5510
225 (EXCAVATORS) S/N: 76U1-UP	
Air Filter Primary.....	A-5549
Air Filter Primary.....	A-5549M
Air Filter Set.....	A-5549M-S
Air Filter Secondary.....	A-5550
Air Filter Set.....	A-5522-S
Air Filter Secondary.....	A-5510
Air Filter Primary.....	A-5509
Fuel Filter Secondary.....	FC-5507
Hydraulic Oil Filter.....	H-5509
Oil Filter Full Flow.....	C-5510
225D (EXCAVATORS) CAT 3304 (S/N: 25J1-UP)	
Air Filter Secondary.....	A-5520
Air Filter Primary.....	A-5543
Air Filter Set.....	A-5544-S
Fuel Filter Secondary.....	FC-5507
Hydraulic Oil Filter.....	H-5509
Hydraulic Oil Filter.....	H-5508
Hydraulic Oil Filter.....	H-5504
Hydraulic Oil Filter.....	H-5503
Hydraulic Oil Filter.....	H-5502
Oil Filter Full Flow.....	C-5519
225B (EXCAVATORS) CAT 3304 (S/N: 22D1-UP)	
Fuel Filter Secondary.....	FC-5507
Hydraulic Oil Filter.....	H-5502
Hydraulic Oil Filter.....	H-5504
Hydraulic Oil Filter.....	H-5508
Hydraulic Oil Filter.....	H-5509
Oil Filter Full Flow.....	C-5519
225B (EXCAVATORS) CAT 3304 (S/N: 22D-UP)	
Air Filter Set.....	A-5522-S
Air Filter Primary.....	A-5509
Air Filter Secondary.....	A-5510
Fuel Filter Secondary.....	FC-5507
Fuel Filter.....	F-5505
Hydraulic Oil Filter.....	H-5509

MODEL/APPLICATION	SAKURA NO
CATERPILLAR	
225B (EXCAVATORS) CAT 3304 (S/N: 2ZD-UP)	
Hydraulic Oil Filter.....	H-5508
Hydraulic Oil Filter.....	H-5504
Hydraulic Oil Filter.....	H-5503
Hydraulic Oil Filter.....	H-5502
Oil Filter Full Flow.....	C-5510
225B (EXCAVATORS) CAT 3304 (S/N: 3YD1-UP)	
Air Filter Secondary.....	A-5510
Air Filter Primary.....	A-5509
Air Filter Set.....	A-5522-S
Fuel Filter.....	F-5505
Fuel Filter Secondary.....	FC-5507
Hydraulic Oil Filter.....	H-5502
Hydraulic Oil Filter.....	H-5503
Hydraulic Oil Filter.....	H-5504
Hydraulic Oil Filter.....	H-5508
Hydraulic Oil Filter.....	H-5509
Oil Filter Full Flow.....	C-5510
225B (EXCAVATORS) CAT 3304 (S/N: 3YD-UP)	
Air Filter Set.....	A-5522-S
Air Filter Primary.....	A-5509
Air Filter Secondary.....	A-5510
Fuel Filter Secondary.....	FC-5507
Fuel Filter.....	F-5505
Hydraulic Oil Filter.....	H-5509
Hydraulic Oil Filter.....	H-5508
Hydraulic Oil Filter.....	H-5504
Hydraulic Oil Filter.....	H-5503
Hydraulic Oil Filter.....	H-5502
Oil Filter Full Flow.....	C-5510
225B (EXCAVATORS) S/N: 1AG1-UP	
Air Filter Primary.....	A-5509
Air Filter Set.....	A-5522-S
Fuel Filter.....	F-5505
Fuel Filter Secondary.....	FC-5507
Hydraulic Oil Filter.....	H-5502
Hydraulic Oil Filter.....	H-5503
Hydraulic Oil Filter.....	H-5504
Hydraulic Oil Filter.....	H-5508
Hydraulic Oil Filter.....	H-5509
Hydraulic Oil Filter.....	H-5520
Hydraulic Oil Filter.....	H-5526
Hydraulic Oil Filter.....	H-55280
Oil Filter Full Flow.....	C-5510
225B LC (EXCAVATORS) CAT 3208 (S/N: 1GF1-UP)	
Air Filter Primary.....	A-5509
Air Filter Set.....	A-5522-S
Air Filter Secondary.....	A-5510
Fuel Filter Secondary.....	FC-5507
Hydraulic Oil Filter.....	H-5504
Hydraulic Oil Filter.....	H-5502
Hydraulic Oil Filter.....	H-5509
Hydraulic Oil Filter.....	H-5508
Oil Filter Full Flow.....	C-5519

MODEL/APPLICATION	SAKURA NO
CATERPILLAR	
225B LC (EXCAVATORS) CAT 3208 (S/N: 2ZD1-UP)	
Air Filter Secondary.....	A-5510
Air Filter Set.....	A-5522-S
Air Filter Primary.....	A-5509
Fuel Filter Secondary.....	FC-5507
Hydraulic Oil Filter.....	H-5502
Hydraulic Oil Filter.....	H-5504
Hydraulic Oil Filter.....	H-5508
Hydraulic Oil Filter.....	H-5509
Oil Filter Full Flow.....	C-5519
225D LC (EXCAVATORS) CAT 3208 (S/N: 6RG1-UP)	
Air Filter Secondary.....	A-5520
Air Filter Set.....	A-5522-S
Air Filter Primary.....	A-5509
Fuel Filter.....	F-5505
Fuel Filter Secondary.....	FC-5507
Hydraulic Oil Filter.....	H-5504
Hydraulic Oil Filter.....	H-5503
Hydraulic Oil Filter.....	H-5508
Hydraulic Oil Filter.....	H-5509
Hydraulic Oil Filter.....	H-5502
Oil Filter Full Flow.....	C-5510
226 (LOADERS) S/N: 5FZ6700-UP	
Air Filter Secondary.....	A-8599
Air Filter Primary.....	A-8505
Hydraulic Oil Filter.....	HC-5504
Oil Filter Full Flow.....	C-5101
226 (LOADERS) S/N: 6BZ1-699	
Air Filter Primary.....	A-8505
Air Filter Secondary.....	A-8599
Hydraulic Oil Filter.....	HC-5504
Oil Filter Full Flow.....	C-5101
226B (LOADERS) CAT 3024C (S/N: MJH1-UP) , 2004-UP	
Air Filter Secondary.....	A-7004
Air Filter Primary.....	A-7003
Hydraulic Oil Filter.....	HC-5504
Oil Filter Full Flow.....	C-1123
226B (LOADERS) CAT 3034 (S/N: MJH1-UP) , 2004-UP	
Air Filter Primary.....	A-7003
Air Filter Secondary.....	A-7004
Hydraulic Oil Filter.....	HC-5504
Oil Filter Full Flow.....	C-1123
227 (EXCAVATORS) S/N: 10W1-UP	
Air Filter Primary.....	A-5509
Air Filter Set.....	A-5522-S
Air Filter Secondary.....	A-5510
Air Filter Set.....	A-5549M-S
Air Filter Secondary.....	A-5550
Air Filter Primary.....	A-5549
Air Filter Primary.....	A-5549M
Fuel Filter Secondary.....	FC-5507

MODEL/APPLICATION	SAKURA NO
CATERPILLAR	
Hydraulic Oil Filter.....	H-5509
Oil Filter Full Flow.....	C-5519
229 (EXCAVATORS) CAT 3304 (S/N: 1AG1-UP)	
Air Filter Primary.....	A-5509
Air Filter Secondary.....	A-5520
Air Filter Set.....	A-5522-S
Fuel Filter.....	F-5505
Fuel Filter Secondary.....	FC-5507
Hydraulic Oil Filter.....	H-5509
Hydraulic Oil Filter.....	H-5508
Hydraulic Oil Filter.....	H-5502
Hydraulic Oil Filter.....	H-5503
Hydraulic Oil Filter.....	H-5504
Oil Filter Full Flow.....	C-5510
229 (EXCAVATORS) CAT 3304 (S/N: 1GF1-UP)	
Air Filter Secondary.....	A-5550
Air Filter Set.....	A-5549M-S
Air Filter Primary.....	A-5509
Air Filter Primary.....	A-5549M
Air Filter Primary.....	A-5549
Air Filter Set.....	A-5522-S
Air Filter Secondary.....	A-5510
Fuel Filter Secondary.....	FC-5507
Hydraulic Oil Filter.....	H-5502
Hydraulic Oil Filter.....	H-5508
Hydraulic Oil Filter.....	H-5509
Hydraulic Oil Filter.....	H-5504
Oil Filter Full Flow.....	C-5519
229 (EXCAVATORS) CAT 3304 (S/N: 2ZD1-UP)	
Air Filter Primary.....	A-5549
Air Filter Primary.....	A-5549M
Air Filter Primary.....	A-5509
Air Filter Set.....	A-5549M-S
Air Filter Secondary.....	A-5550
Air Filter Secondary.....	A-5510
Air Filter Set.....	A-5522-S
Fuel Filter Secondary.....	FC-5507
Hydraulic Oil Filter.....	H-5509
Hydraulic Oil Filter.....	H-5508
Hydraulic Oil Filter.....	H-5502
Hydraulic Oil Filter.....	H-5504
Oil Filter Full Flow.....	C-5519
229 (EXCAVATORS) CAT 3304 (S/N: 3YD1-UP)	
Air Filter Primary.....	A-5509
Air Filter Set.....	A-5522-S
Air Filter Secondary.....	A-5520
Fuel Filter Secondary.....	FC-5507
Fuel Filter.....	F-5505
Hydraulic Oil Filter.....	H-5504
Hydraulic Oil Filter.....	H-5503
Hydraulic Oil Filter.....	H-5502
Hydraulic Oil Filter.....	H-5508
Hydraulic Oil Filter.....	H-5509
Oil Filter Full Flow.....	C-5510

MODEL/APPLICATION	SAKURA NO
CATERPILLAR	
229D (EXCAVATORS) CAT 3304 (S/N: 2LJ1-UP)	
Air Filter Primary.....	A-5509
Air Filter Set.....	A-5522-S
Air Filter Secondary.....	A-5510
Fuel Filter.....	F-5505
Fuel Filter Secondary.....	FC-5507
Hydraulic Oil Filter.....	H-5504
Hydraulic Oil Filter.....	H-5503
Hydraulic Oil Filter.....	H-5502
Hydraulic Oil Filter.....	H-5508
Hydraulic Oil Filter.....	H-5509
Oil Filter Full Flow.....	C-5510
231D (EXCAVATORS) CAT 3208 (S/N: 1NK1-UP)	
Air Filter Secondary.....	A-5520
Air Filter Set.....	A-5544-S
Air Filter Primary.....	A-5543
Fuel Filter Secondary.....	FC-5507
Hydraulic Oil Filter.....	H-5509
Hydraulic Oil Filter.....	H-5508
Hydraulic Oil Filter.....	H-5502
Hydraulic Oil Filter.....	H-5503
Hydraulic Oil Filter.....	H-5504
Oil Filter Full Flow.....	C-5505
231D (EXCAVATORS) CAT 3208 (S/N: 5JW1-UP)	
Air Filter Set.....	A-5544-S
Air Filter Secondary.....	A-5520
Air Filter Primary.....	A-5543
Fuel Filter Secondary.....	FC-5507
Hydraulic Oil Filter.....	H-5504
Hydraulic Oil Filter.....	H-5502
Hydraulic Oil Filter.....	H-5508
Hydraulic Oil Filter.....	H-5509
Oil Filter Full Flow.....	C-5519
231D (EXCAVATORS) CAT 3208 (S/N: 5WJ1-UP)	
Air Filter Secondary.....	A-5520
Air Filter Set.....	A-5544-S
Air Filter Primary.....	A-5543
Fuel Filter Secondary.....	FC-5507
Hydraulic Oil Filter.....	H-5509
Hydraulic Oil Filter.....	H-5508
Hydraulic Oil Filter.....	H-5502
Hydraulic Oil Filter.....	H-5503
Hydraulic Oil Filter.....	H-5504
Oil Filter Full Flow.....	C-5505
231D LC (EXCAVATORS) CAT 3208 (S/N: 5WJ1-UP)	
Air Filter Secondary.....	A-5520
Air Filter Primary.....	A-5543
Air Filter Set.....	A-5544-S
Fuel Filter Secondary.....	FC-5507
Hydraulic Oil Filter.....	H-5504
Hydraulic Oil Filter.....	H-5502
Hydraulic Oil Filter.....	H-5508
Hydraulic Oil Filter.....	H-5509
Oil Filter Full Flow.....	C-5505

MODEL/APPLICATION	SAKURA NO
CATERPILLAR	
232 (LOADERS) CAT 3024C (S/N: CAB1-UP)	
Air Filter Secondary.....	A-8599
Air Filter Primary.....	A-8505
Hydraulic Oil Filter.....	HC-5504
Oil Filter Full Flow.....	C-5101
232 (LOADERS) CAT 3034 (S/N: CAB1-UP)	
Air Filter Primary.....	A-8505
Air Filter Secondary.....	A-8599
Hydraulic Oil Filter.....	HC-5504
Oil Filter Full Flow.....	C-5101
232B (LOADERS) CAT 3024C (S/N: SCH1-UP) , 2004-UP	
Air Filter Primary.....	A-7003
Air Filter Secondary.....	A-7004
Hydraulic Oil Filter.....	HC-5504
Oil Filter Full Flow.....	C-1123
232B (LOADERS) CAT 3034 (S/N: SCH1-UP) , 2004-UP	
Air Filter Primary.....	A-7003
Air Filter Secondary.....	A-7004
Hydraulic Oil Filter.....	HC-5504
Oil Filter Full Flow.....	C-1123
235 (EXCAVATORS) S/N: 32K1-788	
Air Filter Secondary.....	A-5520
Air Filter Set.....	A-5544-S
Air Filter Primary.....	A-5558
Air Filter Primary.....	A-5543
Air Filter Secondary.....	A-5559
Fuel Filter Secondary.....	FC-5507
Hydraulic Oil Filter.....	H-5509
Hydraulic Oil Filter.....	H-5508
Hydraulic Oil Filter.....	H-5504
Hydraulic Oil Filter.....	H-5502
Oil Filter Full Flow.....	C-5510
235 (EXCAVATORS) S/N: 32K789-UP	
Air Filter Secondary.....	A-5559
Air Filter Primary.....	A-5543
Air Filter Primary.....	A-5558
Air Filter Set.....	A-5544-S
Air Filter Secondary.....	A-5520
Fuel Filter Secondary.....	FC-5507
Hydraulic Oil Filter.....	H-5508
Hydraulic Oil Filter.....	H-5509
Hydraulic Oil Filter.....	H-5502
Oil Filter Full Flow.....	C-5510
235 (EXCAVATORS) S/N: 62X1-UP	
Air Filter Secondary.....	A-5520
Air Filter Set.....	A-5544-S
Air Filter Primary.....	A-5558
Air Filter Primary.....	A-5543
Air Filter Secondary.....	A-5559
Fuel Filter Secondary.....	FC-5507
Hydraulic Oil Filter.....	H-5508
Hydraulic Oil Filter.....	H-5509
Hydraulic Oil Filter.....	H-5502
Oil Filter Full Flow.....	C-5510

MODEL/APPLICATION	SAKURA NO
CATERPILLAR	
Hydraulic Oil Filter.....	H-5508
Hydraulic Oil Filter.....	H-5502
Hydraulic Oil Filter.....	H-5504
Oil Filter Full Flow.....	C-5510
235 (EXCAVATORS) S/N: 64X1-UP	
Air Filter Secondary.....	A-5559
Air Filter Primary.....	A-5543
Air Filter Primary.....	A-5558
Air Filter Set.....	A-5544-S
Air Filter Secondary.....	A-5520
Fuel Filter Secondary.....	FC-5507
Hydraulic Oil Filter.....	H-5504
Hydraulic Oil Filter.....	H-5502
Hydraulic Oil Filter.....	H-5508
Hydraulic Oil Filter.....	H-5509
Oil Filter Full Flow.....	C-5510
235 (EXCAVATORS) S/N: 7WC1-UP	
Air Filter Secondary.....	A-5520
Air Filter Set.....	A-5544-S
Air Filter Primary.....	A-5558
Air Filter Primary.....	A-5543
Air Filter Secondary.....	A-5559
Fuel Filter Secondary.....	FC-5507
Hydraulic Oil Filter.....	H-5509
Hydraulic Oil Filter.....	H-5508
Hydraulic Oil Filter.....	H-5502
Oil Filter Full Flow.....	C-5510
235 (EXCAVATORS) S/N: 81X1-UP	
Air Filter Secondary.....	A-5559
Air Filter Primary.....	A-5543
Air Filter Primary.....	A-5558
Air Filter Set.....	A-5544-S
Air Filter Secondary.....	A-5520
Fuel Filter Secondary.....	FC-5507
Hydraulic Oil Filter.....	H-5502
Hydraulic Oil Filter.....	H-5504
Hydraulic Oil Filter.....	H-5508
Hydraulic Oil Filter.....	H-5509
Oil Filter Full Flow.....	C-5510
235 (EXCAVATORS) S/N: 83X1-UP	
Air Filter Secondary.....	A-5520
Air Filter Set.....	A-5544-S
Air Filter Primary.....	A-5558
Air Filter Primary.....	A-5543
Air Filter Secondary.....	A-5559
Fuel Filter Secondary.....	FC-5507
Hydraulic Oil Filter.....	H-5509
Hydraulic Oil Filter.....	H-5508
Hydraulic Oil Filter.....	H-5504
Hydraulic Oil Filter.....	H-5502
Oil Filter Full Flow.....	C-5510
235 (EXCAVATORS) S/N: 9PC1-UP	
Air Filter Secondary.....	A-5559
Air Filter Primary.....	A-5543

MODEL/APPLICATION	SAKURA NO
CATERPILLAR	
235 (EXCAVATORS) S/N: 9PC1-UP	
Air Filter Primary.....	A-5558
Air Filter Set.....	A-5544-S
Air Filter Secondary.....	A-5520
Fuel Filter Secondary.....	FC-5507
Hydraulic Oil Filter.....	H-5508
Hydraulic Oil Filter.....	H-5509
Hydraulic Oil Filter.....	H-5502
Oil Filter Full Flow.....	C-5510
235C (EXCAVATORS) CAT 3306 (S/N: 2PG1-UP)	
Air Filter Secondary.....	A-5520
Air Filter Primary.....	A-5543
Air Filter Set.....	A-5544-S
Fuel Filter Secondary.....	FC-5507
Fuel Filter.....	F-5505
Hydraulic Oil Filter.....	H-5504
Hydraulic Oil Filter.....	H-5508
Hydraulic Oil Filter.....	H-5509
Hydraulic Oil Filter.....	H-5503
Hydraulic Oil Filter.....	H-5502
Oil Filter Full Flow.....	C-5510
235C (EXCAVATORS) CAT 3306 (S/N: 3WG1-UP)	
Air Filter Set.....	A-5544-S
Air Filter Primary.....	A-5543
Air Filter Secondary.....	A-5520
Fuel Filter.....	F-5505
Fuel Filter Secondary.....	FC-5507
Hydraulic Oil Filter.....	H-5502
Hydraulic Oil Filter.....	H-5503
Hydraulic Oil Filter.....	H-5509
Hydraulic Oil Filter.....	H-5508
Hydraulic Oil Filter.....	H-5504
Oil Filter Full Flow.....	C-5510
235C (EXCAVATORS) CAT 3306 (S/N: 4DG1-UP)	
Air Filter Secondary.....	A-5520
Air Filter Primary.....	A-5543
Air Filter Set.....	A-5544-S
Fuel Filter.....	F-5505
Fuel Filter Secondary.....	FC-5507
Hydraulic Oil Filter.....	H-5504
Hydraulic Oil Filter.....	H-5508
Hydraulic Oil Filter.....	H-5509
Hydraulic Oil Filter.....	H-5503
Hydraulic Oil Filter.....	H-5502
Oil Filter Full Flow.....	C-5510
235C (EXCAVATORS) CAT 3306 (S/N: 5AF1-UP)	
Air Filter Set.....	A-5544-S
Air Filter Set.....	A-5549M-S
Air Filter Secondary.....	A-5550
Air Filter Primary.....	A-5543
Air Filter Primary.....	A-5549
Air Filter Primary.....	A-5549M
Air Filter Primary.....	A-5558
Air Filter Secondary.....	A-5520

MODEL/APPLICATION	SAKURA NO
CATERPILLAR	
Air Filter Secondary.....	A-5559
Fuel Filter Secondary.....	FC-5507
Fuel Filter.....	F-5505
Hydraulic Oil Filter.....	H-5502
Hydraulic Oil Filter.....	H-5509
Hydraulic Oil Filter.....	H-5508
Hydraulic Oil Filter.....	H-5504
Oil Filter Full Flow.....	C-5510
235D (EXCAVATORS) CAT 3306 (S/N: 8KJ1-UP)	
Air Filter Secondary.....	A-5520
Air Filter Set.....	A-5544-S
Air Filter Primary.....	A-5543
Fuel Filter.....	F-5505
Fuel Filter Secondary.....	FC-5507
Hydraulic Oil Filter.....	H-5509
Hydraulic Oil Filter.....	H-5508
Hydraulic Oil Filter.....	H-5502
Hydraulic Oil Filter.....	H-5503
Hydraulic Oil Filter.....	H-5504
Oil Filter Full Flow.....	C-5510
235D (EXCAVATORS) CAT 3306 (S/N: 8TJ1-UP)	
Air Filter Primary.....	A-5543
Air Filter Set.....	A-5544-S
Air Filter Secondary.....	A-5520
Fuel Filter Secondary.....	FC-5507
Fuel Filter.....	F-5505
Hydraulic Oil Filter.....	H-5504
Hydraulic Oil Filter.....	H-5503
Hydraulic Oil Filter.....	H-5502
Hydraulic Oil Filter.....	H-5508
Hydraulic Oil Filter.....	H-5509
Oil Filter Full Flow.....	C-5510
235B (EXCAVATORS) CAT 3306 (S/N: 1FD1-UP)	
Air Filter Secondary.....	A-5520
Air Filter Primary.....	A-5543
Air Filter Set.....	A-5544-S
Fuel Filter.....	F-5505
Fuel Filter Secondary.....	FC-5507
Hydraulic Oil Filter.....	H-5504
Hydraulic Oil Filter.....	H-5503
Hydraulic Oil Filter.....	H-5502
Hydraulic Oil Filter.....	H-5508
Hydraulic Oil Filter.....	H-5509
Hydraulic Oil Filter.....	H-5508
Oil Filter Full Flow.....	C-5510
235B (EXCAVATORS) CAT 3306 (S/N: 4ED1-UP)	
Air Filter Set.....	A-5544-S
Air Filter Primary.....	A-5543
Air Filter Secondary.....	A-5520
Fuel Filter.....	F-5505
Fuel Filter Secondary.....	FC-5507
Hydraulic Oil Filter.....	H-5508
Hydraulic Oil Filter.....	H-5509
Hydraulic Oil Filter.....	H-5502
Hydraulic Oil Filter.....	H-5503
Hydraulic Oil Filter.....	H-5504

MODEL/APPLICATION	SAKURA NO
CATERPILLAR	
Oil Filter Full Flow.....	C-5510
235B (EXCAVATORS) CAT 3306 (S/N: 7WC1-UP)	
Air Filter Secondary.....	A-5520
Air Filter Primary.....	A-5543
Air Filter Set.....	A-5544-S
Fuel Filter.....	F-5505
Fuel Filter Secondary.....	FC-5507
Hydraulic Oil Filter.....	H-5504
Hydraulic Oil Filter.....	H-5503
Hydraulic Oil Filter.....	H-5502
Hydraulic Oil Filter.....	H-5509
Hydraulic Oil Filter.....	H-5508
Oil Filter Full Flow.....	C-5510
235B (EXCAVATORS) CAT 3306 (S/N: 9PC1-UP)	
Air Filter Secondary.....	A-5520
Air Filter Set.....	A-5544-S
Air Filter Primary.....	A-5543
Fuel Filter.....	F-5505
Fuel Filter Secondary.....	FC-5507
Hydraulic Oil Filter.....	H-5508
Hydraulic Oil Filter.....	H-5509
Hydraulic Oil Filter.....	H-5502
Hydraulic Oil Filter.....	H-5503
Hydraulic Oil Filter.....	H-5504
Oil Filter Full Flow.....	C-5510
236 (LOADERS) S/N: 4YZ1-3999	
Air Filter Primary.....	A-8505
Air Filter Set.....	A-5541M-S
Air Filter Secondary.....	A-5540
Air Filter Primary.....	A-5541
Air Filter Primary.....	A-5541M
Air Filter Primary.....	A-76231
Air Filter Secondary.....	A-8599
Hydraulic Oil Filter.....	HC-5504
Oil Filter Full Flow.....	C-5101
236 (LOADERS) S/N: 4YZ4000-UP	
Air Filter Secondary.....	A-8599
Air Filter Primary.....	A-76231
Air Filter Primary.....	A-5541M
Air Filter Primary.....	A-5541
Air Filter Secondary.....	A-5540
Air Filter Set.....	A-5541M-S
Air Filter Primary.....	A-8505
Hydraulic Oil Filter.....	HC-5504
Oil Filter Full Flow.....	C-5101
236 (LOADERS) S/N: 5SZ1-3999	
Air Filter Set.....	A-5541M-S
Air Filter Secondary.....	A-5540
Air Filter Primary.....	A-5541
Air Filter Primary.....	A-5541M
Air Filter Primary.....	A-76231
Hydraulic Oil Filter.....	HC-5504
Oil Filter Full Flow.....	C-5101

MODEL/APPLICATION	SAKURA NO
CATERPILLAR	
236 (LOADERS) S/N: 5S24000-UP	
Air Filter Primary.....	A-76231
Air Filter Secondary.....	A-8599
Air Filter Primary.....	A-5541M
Air Filter Primary.....	A-5541
Air Filter Secondary.....	A-5540
Air Filter Set.....	A-5541M-S
Air Filter Primary.....	A-8505
Hydraulic Oil Filter.....	HC-5504
Oil Filter Full Flow.....	C-5101
236 (LOADERS) S/N: 6LZ1000-UP	
Air Filter Set.....	A-5541M-S
Air Filter Secondary.....	A-5540
Air Filter Primary.....	A-5541
Air Filter Primary.....	A-5541M
Air Filter Primary.....	A-76231
Hydraulic Oil Filter.....	HC-5504
Oil Filter Full Flow.....	C-5101
236 (LOADERS) S/N: 6LZ1-999	
Air Filter Secondary.....	A-8599
Air Filter Primary.....	A-8505
Hydraulic Oil Filter.....	HC-5504
Oil Filter Full Flow.....	C-5101
236 (LOADERS) S/N: CED1-UP	
Air Filter Primary.....	A-76231
Air Filter Primary.....	A-5541M
Air Filter Primary.....	A-5541
Air Filter Secondary.....	A-5540
Air Filter Set.....	A-5541M-S
Hydraulic Oil Filter.....	HC-5504
Oil Filter Full Flow.....	C-5101
236 (LOADERS) S/N: FDG1-UP	
Air Filter Secondary.....	A-8599
Air Filter Primary.....	A-8505
Hydraulic Oil Filter.....	HC-5504
Oil Filter Full Flow.....	C-5101
236B (LOADERS) S/N: HEN1-UP , 2004-UP	
Air Filter Secondary.....	A-5540
Hydraulic Oil Filter.....	HC-5504
Oil Filter Full Flow.....	C-5504
242 (LOADERS) CAT 3024C (S/N: CMB1-UP)	
Air Filter Primary.....	A-8505
Air Filter Secondary.....	A-8599
Hydraulic Oil Filter.....	HC-5504
Oil Filter Full Flow.....	C-5101
242 (LOADERS) CAT 3034 (S/N: CMB1-UP)	
Air Filter Secondary.....	A-8599
Air Filter Primary.....	A-8505
Hydraulic Oil Filter.....	HC-5504

MODEL/APPLICATION	SAKURA NO
CATERPILLAR	
Oil Filter Full Flow.....	C-5101
242B (LOADERS) CAT 3024C (S/N: 5S24000-UP) , 2004-UP	
Air Filter Secondary.....	A-8599
Air Filter Primary.....	A-8505
Hydraulic Oil Filter.....	HC-5504
Oil Filter Full Flow.....	C-5101
242B (LOADERS) CAT 3034 (S/N: 5S24000-UP) , 2004-UP	
Air Filter Secondary.....	A-8599
Air Filter Primary.....	A-8505
Hydraulic Oil Filter.....	HC-5504
Oil Filter Full Flow.....	C-5101
242B (LOADERS) CAT 3024C (S/N: BXM1-UP)	
Air Filter Primary.....	A-7003
Air Filter Secondary.....	A-7004
Hydraulic Oil Filter.....	HC-5504
Oil Filter Full Flow.....	C-1123
242B (LOADERS) CAT 3034 (S/N: BXM1-UP)	
Air Filter Primary.....	A-7003
Air Filter Secondary.....	A-7004
Hydraulic Oil Filter.....	HC-5504
Oil Filter Full Flow.....	C-1123
245 (EXCAVATORS) S/N: 82X1-UP	
Air Filter Secondary.....	A-5502
Air Filter Primary.....	A-5535
Air Filter Set.....	A-5573-S
Air Filter Secondary.....	A-5534
Air Filter Primary.....	A-5501
Fuel Filter.....	FC-5509
Fuel Filter.....	FC-5519
Hydraulic Oil Filter.....	H-5509
Oil Filter Full Flow.....	C-5516
245 (EXCAVATORS) S/N: 84X1-UP	
Air Filter Primary.....	A-5501
Air Filter Secondary.....	A-5534
Air Filter Set.....	A-5573-S
Air Filter Primary.....	A-5535
Air Filter Secondary.....	A-5502
Fuel Filter.....	FC-5519
Fuel Filter.....	FC-5509
Hydraulic Oil Filter.....	H-5509
Oil Filter Full Flow.....	C-5516
245 (EXCAVATORS) S/N: 95V1-470	
Air Filter Secondary.....	A-5534
Air Filter Primary.....	A-5501
Air Filter Secondary.....	A-5502
Air Filter Primary.....	A-5535
Air Filter Set.....	A-5573-S
Fuel Filter.....	FC-5509
Fuel Filter.....	FC-5519
Hydraulic Oil Filter.....	H-5509
Oil Filter Full Flow.....	C-5516

MODEL/APPLICATION	SAKURA NO
CATERPILLAR	
245 (EXCAVATORS) S/N: 95V471-UP	
Air Filter Primary.....	A-5501
Air Filter Secondary.....	A-5534
Air Filter Set.....	A-5573-S
Air Filter Primary.....	A-5535
Air Filter Secondary.....	A-5502
Fuel Filter.....	FC-5519
Fuel Filter.....	FC-5509
Hydraulic Oil Filter.....	H-5509
Oil Filter Full Flow.....	C-5516
245B (EXCAVATORS) CAT 3406 (S/N: 1S31-712-UP)	
Air Filter Secondary.....	A-5529
Air Filter Primary.....	A-5521
Air Filter Set.....	A-5521-S
Fuel Filter.....	F-5505
Fuel Filter.....	FC-5509
Hydraulic Oil Filter.....	H-5509
Hydraulic Oil Filter.....	H-5508
Hydraulic Oil Filter.....	H-5502
Oil Filter Full Flow.....	C-5516
245B (EXCAVATORS) CAT 3406 (S/N: 6MF1-512-UP)	
Air Filter Primary.....	A-5555
Air Filter Set.....	A-5555-S
Air Filter Secondary.....	A-5556
Air Filter Set.....	A-5521-S
Air Filter Primary.....	A-5521
Air Filter Secondary.....	A-5529
Fuel Filter.....	FC-5509
Fuel Filter.....	F-5505
Hydraulic Oil Filter.....	H-5502
Hydraulic Oil Filter.....	H-5508
Hydraulic Oil Filter.....	H-5509
245B (EXCAVATORS) CAT 3406 (S/N: 6MF513-UP)	
Fuel Filter.....	F-5505
Fuel Filter.....	FC-5509
Hydraulic Oil Filter.....	H-5509
Hydraulic Oil Filter.....	H-5508
Hydraulic Oil Filter.....	H-5502
245B (EXCAVATORS) S/N: 6MF00369-6MF00654	
Air Filter Primary.....	A-5521
Air Filter Set.....	A-5521-S
Air Filter Secondary.....	A-5529
Fuel Filter.....	FC-5519
Hydraulic Oil Filter.....	H-5502
Hydraulic Oil Filter.....	H-5508
Oil Filter Full Flow.....	C-5516
245B II (EXCAVATORS) CAT S/N: 11N1-UP	
Fuel Filter.....	FC-5509
Fuel Filter.....	FC-5519
Hydraulic Oil Filter.....	H-5502
Hydraulic Oil Filter.....	H-5508
Hydraulic Oil Filter.....	H-5509

MODEL/APPLICATION	SAKURA NO
-------------------	-----------

CATERPILLAR

245B II
(EXCAVATORS)
CAT S/N: 6MF1-UP

Fuel Filter.....	FC-5519
Fuel Filter.....	FC-5509
Hydraulic Oil Filter.....	H-5509
Hydraulic Oil Filter.....	H-5508
Hydraulic Oil Filter.....	H-5502

245B SERIES II
(EXCAVATORS)
CAT 3406 (S/N: 15J713-UP)

Air Filter Set.....	A-5521-S
Air Filter Primary.....	A-5521
Air Filter Secondary.....	A-5529
Fuel Filter.....	F-5505
Fuel Filter.....	FC-5509
Hydraulic Oil Filter.....	H-5509
Hydraulic Oil Filter.....	H-5508
Hydraulic Oil Filter.....	H-5502

245B SERIES II
(EXCAVATORS)
CAT 3406 (S/N: 6MF513-UP)

Air Filter Secondary.....	A-5529
Air Filter Primary.....	A-5521
Air Filter Set.....	A-5521-S
Coolant Filter.....	WC-5707
Fuel Filter.....	FC-5509
Fuel Filter.....	F-5505
Hydraulic Oil Filter.....	H-5508
Hydraulic Oil Filter.....	H-5509
Hydraulic Oil Filter.....	H-5502

245D
(EXCAVATORS)
CAT 3406 (S/N: 4LK1-UP)

Air Filter Secondary.....	A-5529
Air Filter Primary.....	A-5521
Air Filter Set.....	A-5521-S
Fuel Filter.....	F-5505
Fuel Filter.....	FC-5509
Hydraulic Oil Filter.....	H-5502
Hydraulic Oil Filter.....	H-5508
Hydraulic Oil Filter.....	H-5509

245D
(EXCAVATORS)
CAT 3406 (S/N: 7ZJ1-UP)

Air Filter Secondary.....	A-5529
Air Filter Set.....	A-5521-S
Air Filter Primary.....	A-5521
Fuel Filter.....	FC-5509
Fuel Filter.....	F-5505
Hydraulic Oil Filter.....	H-5509
Hydraulic Oil Filter.....	H-5508
Hydraulic Oil Filter.....	H-5502

246
(LOADERS)
CAT 3034 S/N: 3NW17565-UP , 2001

Air Filter Set.....	A-5541M-S
Air Filter Primary.....	A-76231
Air Filter Secondary.....	A-5540
Air Filter Primary.....	A-5541M
Air Filter Primary.....	A-5541
Hydraulic Oil Filter.....	HC-5504
Oil Filter Full Flow.....	C-5101

MODEL/APPLICATION	SAKURA NO
-------------------	-----------

CATERPILLAR

246
(LOADERS)
CAT 3034 S/N: 59203641-UP , 2001

Air Filter Primary.....	A-5541
Air Filter Primary.....	A-5541M
Air Filter Secondary.....	A-5540
Air Filter Primary.....	A-76231
Air Filter Set.....	A-5541M-S
Hydraulic Oil Filter.....	HC-5504
Oil Filter Full Flow.....	C-5101

246
(LOADERS)
CAT 3034 (S/N: 5SZ1-3999-UP)

Air Filter Secondary.....	A-5540
Hydraulic Oil Filter.....	HC-5504
Oil Filter Full Flow.....	C-5101

246
(LOADERS)
S/N: 4YZ1-3999

Air Filter Primary.....	A-8505
Air Filter Secondary.....	A-8599
Hydraulic Oil Filter.....	HC-5504
Oil Filter Full Flow.....	C-5101

246B
(LOADERS)
S/N: PAT1-UP , 2004-UP

Air Filter Secondary.....	A-5540
Hydraulic Oil Filter.....	HC-5504
Oil Filter Full Flow.....	C-5504

246C
(LOADERS)
CAT S/N: CJS1-UP , 2007-UP

Air Filter Primary.....	A-76231
Air Filter Secondary.....	A-5540
Air Filter Primary.....	A-5541
Air Filter Primary.....	A-5541M
Air Filter Set.....	A-5541M-S
Hydraulic Oil Filter.....	HC-5504
Oil Filter Full Flow.....	C-5504

246C
(LOADERS)
CAT S/N: JAY1-UP , 2007-UP

Air Filter Set.....	A-5541M-S
Air Filter Primary.....	A-5541M
Air Filter Primary.....	A-5541
Air Filter Secondary.....	A-5540
Air Filter Primary.....	A-76231
Hydraulic Oil Filter.....	HC-5504
Oil Filter Full Flow.....	C-5504

247
(LOADERS)
CAT 3034 (S/N: CML1-UP)

Air Filter Secondary.....	A-8599
Air Filter Primary.....	A-8505
Hydraulic Oil Filter.....	HC-5504
Oil Filter Full Flow.....	C-5101

248
(LOADERS)
S/N: 6LZ1-999

Air Filter Set.....	A-5541M-S
Air Filter Primary.....	A-5541M
Air Filter Primary.....	A-5541
Air Filter Secondary.....	A-5540
Air Filter Primary.....	A-8505
Air Filter Secondary.....	A-8599

MODEL/APPLICATION	SAKURA NO
-------------------	-----------

CATERPILLAR

Air Filter Primary.....	A-76231
Hydraulic Oil Filter.....	HC-5504
Oil Filter Full Flow.....	C-5101

248
(LOADERS)
S/N: FYZ1-3999

Air Filter Primary.....	A-76231
Air Filter Secondary.....	A-8599
Air Filter Primary.....	A-8505
Air Filter Secondary.....	A-5540
Air Filter Primary.....	A-5541
Air Filter Primary.....	A-5541M
Air Filter Set.....	A-5541M-S
Hydraulic Oil Filter.....	HC-5504
Oil Filter Full Flow.....	C-5101

248B
(LOADERS)
S/N: SCL1-UP , 2004-UP

Air Filter Secondary.....	A-5540
Hydraulic Oil Filter.....	HC-5504
Oil Filter Full Flow.....	C-5504

24H
(MOTOR GRADERS)
CAT 3412E HEUI , 1996-2007

Fuel/Water Separator Primary....	SFC-5504-30
Fuel/Water Separator Primary....	SFC-5504-30B

24H
(MOTOR GRADERS)
CAT (S/N: 80M1-UP)

Fuel Filter.....	FC-5509
Fuel Filter.....	FC-5517

24H
(MOTOR GRADERS)
CAT 3412E HEUI (S/N: 7KK1-UP)

Air Filter Primary.....	A-5593
Air Filter Secondary.....	A-5594
Air Filter Set.....	A-5595-S
Fuel Filter.....	FC-5509
Hydraulic Oil Filter.....	H-5526
Hydraulic Oil Filter.....	HC-55200
Hydraulic Oil Filter.....	HC-55300
Hydraulic Oil Filter.....	HC-5516
Hydraulic Oil Filter.....	H-5506
Hydraulic Oil Filter.....	H-5503
Hydraulic Oil Filter.....	H-55280

24H
(MOTOR GRADERS)
S/N: 7KK1-66-UP

Air Filter Set.....	A-5595-S
Air Filter Secondary.....	A-5594
Air Filter Primary.....	A-5593
Cabin Air Filter.....	CA-5501
Fuel/Water Separator Secondary..	SFC-5504-10
Fuel/Water Separator Secondary..	SFC-5504-10B
Hydraulic Oil Filter.....	H-55280
Hydraulic Oil Filter.....	H-5503
Hydraulic Oil Filter.....	H-5506
Hydraulic Oil Filter.....	HC-55300
Hydraulic Oil Filter.....	HC-55200
Hydraulic Oil Filter.....	H-5526

24H
(MOTOR GRADERS)
S/N: 7KK67-UP

Air Filter Primary.....	A-5593
Air Filter Set.....	A-8506-S

Sakura Filter

ENGINE APPLICATION

MODEL/APPLICATION	SAKURA NO
CATERPILLAR	
24H (MOTOR GRADERS) S/N: 7KK67-UP	
Air Filter Primary.....	A-8506
Air Filter Secondary.....	A-5594
Air Filter Set.....	A-5595-S
Cabin Air Filter.....	CA-5501
Fuel/Water Separator Secondary..	SFC-5504-10B
Fuel/Water Separator Secondary..	SFC-5504-10
Hydraulic Oil Filter.....	H-5526
Hydraulic Oil Filter.....	HC-55200
Hydraulic Oil Filter.....	HC-55300
Hydraulic Oil Filter.....	H-5506
Hydraulic Oil Filter.....	H-5503
Hydraulic Oil Filter.....	H-55280
252 (LOADERS) S/N: 4YZ4000-UP	
Air Filter Primary.....	A-5541M
Air Filter Set.....	A-5541M-S
Air Filter Primary.....	A-8505
Air Filter Secondary.....	A-8599
Air Filter Primary.....	A-76231
Air Filter Secondary.....	A-5540
Air Filter Primary.....	A-5541
Hydraulic Oil Filter.....	HC-5504
Oil Filter Full Flow.....	C-5101
252 (LOADERS) S/N: 5S24000-UP	
Air Filter Primary.....	A-76231
Air Filter Secondary.....	A-8599
Air Filter Primary.....	A-8505
Air Filter Set.....	A-5541M-S
Air Filter Primary.....	A-5541M
Air Filter Primary.....	A-5541
Air Filter Secondary.....	A-5540
Hydraulic Oil Filter.....	HC-5504
Oil Filter Full Flow.....	C-5101
252B (LOADERS) S/N: FDG1-UP	
Air Filter Secondary.....	A-5540
Hydraulic Oil Filter.....	HC-5504
Oil Filter Full Flow.....	C-5504
256C (LOADERS) CAT S/N: CJS1-UP	
Air Filter Secondary.....	A-5540
Air Filter Primary.....	A-5541M
Air Filter Primary.....	A-5541
Air Filter Set.....	A-5541M-S
Air Filter Primary.....	A-76231
Hydraulic Oil Filter.....	HC-5504
Oil Filter Full Flow.....	C-5504
256C (LOADERS) CAT S/N: DWS1-UP	
Air Filter Primary.....	A-76231
Air Filter Set.....	A-5541M-S
Air Filter Primary.....	A-5541
Air Filter Primary.....	A-5541M
Air Filter Secondary.....	A-5540
Hydraulic Oil Filter.....	HC-5504
Oil Filter Full Flow.....	C-5504

MODEL/APPLICATION	SAKURA NO
CATERPILLAR	
257 (LOADERS) CAT 3034 (S/N: CMM1-UP)	
Air Filter Secondary.....	A-5540
Air Filter Secondary.....	A-8599
Air Filter Primary.....	A-8505
Hydraulic Oil Filter.....	HC-5504
Oil Filter Full Flow.....	C-5101
262 (LOADERS) S/N: 4YZ4000-UP	
Air Filter Secondary.....	A-5540
Air Filter Primary.....	A-5541
Air Filter Primary.....	A-5541M
Air Filter Set.....	A-5541M-S
Air Filter Primary.....	A-8505
Air Filter Secondary.....	A-8599
Air Filter Primary.....	A-76231
Hydraulic Oil Filter.....	HC-5504
262B (LOADERS) S/N: PDT1-UP , 2004-UP	
Air Filter Secondary.....	A-5540
Hydraulic Oil Filter.....	HC-5504
Oil Filter Full Flow.....	C-5504
262C (LOADERS) CAT S/N: CJS1-UP	
Air Filter Secondary.....	A-5540
Air Filter Primary.....	A-5541M
Air Filter Primary.....	A-5541
Air Filter Set.....	A-5541M-S
Air Filter Primary.....	A-76231
Hydraulic Oil Filter.....	HC-5504
Oil Filter Full Flow.....	C-5504
262C (LOADERS) CAT S/N: MST1-UP	
Air Filter Secondary.....	A-5540
Air Filter Primary.....	A-76231
Air Filter Set.....	A-5541M-S
Air Filter Primary.....	A-5541
Air Filter Primary.....	A-5541M
Hydraulic Oil Filter.....	HC-5504
Oil Filter Full Flow.....	C-5504
267 (LOADERS) CAT 3034 (S/N: CMP1-UP)	
Air Filter Secondary.....	A-5540
Air Filter Secondary.....	A-8599
Air Filter Primary.....	A-8505
Hydraulic Oil Filter.....	HC-5504
Oil Filter Full Flow.....	C-5101
267B (LOADERS) CAT 3034 (S/N: CYC1-UP)	
Air Filter Secondary.....	A-5540
Hydraulic Oil Filter.....	HC-5504
Oil Filter Full Flow.....	C-5504
268B (LOADERS) CAT 3044C (S/N: LBA1-UP) , 2004-UP	
Air Filter Secondary.....	A-5540
Hydraulic Oil Filter.....	HC-5504
Oil Filter Full Flow.....	C-5504

MODEL/APPLICATION	SAKURA NO
CATERPILLAR	
272C (LOADERS) CAT S/N: CJS1-UP	
Air Filter Secondary.....	A-5540
Air Filter Primary.....	A-5541
Air Filter Primary.....	A-5541M
Air Filter Set.....	A-5541M-S
Air Filter Primary.....	A-76231
Hydraulic Oil Filter.....	HC-5504
Oil Filter Full Flow.....	C-5504
272C (LOADERS) CAT S/N: RED1-UP	
Air Filter Secondary.....	A-5540
Air Filter Primary.....	A-5541M
Air Filter Primary.....	A-5541
Air Filter Primary.....	A-76231
Air Filter Set.....	A-5541M-S
Hydraulic Oil Filter.....	HC-5504
Oil Filter Full Flow.....	C-5504
277 (LOADERS) CAT 3034 (S/N: CNC1-UP)	
Air Filter Secondary.....	A-5540
Hydraulic Oil Filter.....	HC-5504
Oil Filter Full Flow.....	C-5101
277B (LOADERS) CAT 3034 (S/N: MDH1-UP)	
Air Filter Secondary.....	A-5540
Hydraulic Oil Filter.....	HC-5504
Oil Filter Full Flow.....	C-5504
277C (LOADERS) CAT S/N: CJS1-UP	
Air Filter Secondary.....	A-5540
Air Filter Primary.....	A-5541M
Air Filter Primary.....	A-5541
Air Filter Set.....	A-5541M-S
Air Filter Primary.....	A-76231
Hydraulic Oil Filter.....	HC-5504
Oil Filter Full Flow.....	C-5504
277C (LOADERS) CAT S/N: JWF1-UP	
Air Filter Primary.....	A-76231
Air Filter Set.....	A-5541M-S
Air Filter Primary.....	A-5541
Air Filter Primary.....	A-5541M
Air Filter Secondary.....	A-5540
Hydraulic Oil Filter.....	HC-5504
Oil Filter Full Flow.....	C-5504
287 (LOADERS) CAT 3034 (S/N: CNY1-UP)	
Air Filter Secondary.....	A-5540
Hydraulic Oil Filter.....	HC-5504
Oil Filter Full Flow.....	C-5101
287B (LOADERS) CAT 3034 (S/N: ZSA1-UP)	
Air Filter Secondary.....	A-5540
Hydraulic Oil Filter.....	HC-5504
Oil Filter Full Flow.....	C-5504

MODEL/APPLICATION	SAKURA NO	MODEL/APPLICATION	SAKURA NO	MODEL/APPLICATION	SAKURA NO
CATERPILLAR		CATERPILLAR		CATERPILLAR	
287C (LOADERS) CAT S/N: CJS1--UP , 2007-UP Air Filter Primary..... A-5541 Air Filter Primary..... A-5541M Air Filter Secondary..... A-5540 Air Filter Set..... A-5541M-S Air Filter Primary..... A-76231 Hydraulic Oil Filter..... HC-5504 Oil Filter Full Flow..... C-5504		302 (EXCAVATORS) CAT 3003 (S/N: BFA1-UP) Oil Filter Full Flow..... C-1123 Oil Filter Full Flow..... C-5504 302.5C (EXCAVATORS) CAT (S/N: 4ZW1-UP) Air Filter Secondary..... A-8610 Oil Filter Full Flow..... C-1906 Oil Filter Full Flow..... C-1123		305 (EXCAVATORS) S/N: DSA1-UP Air Filter Secondary..... A-5569 Oil Filter Full Flow..... C-1720 305C (EXCAVATORS) S/N: HWJ1-UP Air Filter Secondary..... A-8599 Air Filter Primary..... A-8505 Oil Filter Full Flow..... C-1720	
287C (LOADERS) CAT S/N: GCP1-UP , 2007-UP Air Filter Secondary..... A-5540 Air Filter Primary..... A-5541M Air Filter Primary..... A-5541 Air Filter Primary..... A-76231 Air Filter Set..... A-5541M-S Hydraulic Oil Filter..... HC-5504 Oil Filter Full Flow..... C-5504		303 (EXCAVATORS) CAT 3013 (S/N: 4AZ1-UP) Air Filter Secondary..... A-5569 Oil Filter Full Flow..... C-1123 303 (EXCAVATORS) S/N: DMA1-UP Air Filter Secondary..... A-5569 303.5C (EXCAVATORS) S/N: DMY1-UP Air Filter Secondary..... A-5569 Oil Filter Full Flow..... C-1720		305 CR (EXCAVATORS) CAT 3054B (S/N: DGT1-UP) , 2004-UP Air Filter Secondary..... A-5569 Oil Filter Full Flow..... C-1720 305 CR (EXCAVATORS) CAT 3054B (S/N: DSA1-UP) Air Filter Secondary..... A-5569 Oil Filter Full Flow..... C-1720	
287C (LOADERS) CAT S/N: MAS1-UP , 2007-UP Air Filter Set..... A-5541M-S Air Filter Primary..... A-76231 Air Filter Primary..... A-5541 Air Filter Primary..... A-5541M Air Filter Secondary..... A-5540 Hydraulic Oil Filter..... HC-5504 Oil Filter Full Flow..... C-5504		303C (EXCAVATORS) S/N: BXT1-UP Air Filter Secondary..... A-5569 Oil Filter Full Flow..... C-1720 304 (EXCAVATORS) S/N: AFW1-UP Air Filter Secondary..... A-5569 Oil Filter Full Flow..... C-1123		3054C (ENGINES) Fuel/Water Separator..... SFC-43040 3054E (ENGINES) Fuel/Water Separator..... SFC-43040	
2P5000 (FORKLIFTS) w/Mitsubishi K25 Eng. Air Filter Primary..... A-85134		304 (EXCAVATORS) S/N: DMA1-UP Air Filter Secondary..... A-5569 304 (EXCAVATORS) S/N: NAD1-1627-UP Air Filter Secondary..... A-5569 Oil Filter Full Flow..... C-1720		306 (EXCAVATORS) CAT S/N: CXZ1-UP Air Filter Primary..... A-8505 Fuel Filter..... FC-5516 Fuel Filter..... FC-10022 Fuel Filter Secondary..... FC-55151 Fuel Filter Secondary..... FC-5515 Fuel Filter..... FC-1002 Oil Filter Full Flow..... C-5505 Oil Filter Full Flow..... C-5522 Oil Filter Full Flow..... C-5510	
3 (EXCAVATORS) CAT 3116 Air Filter Secondary..... A-6007 Oil Filter Full Flow..... C-7105		304 (EXCAVATORS) S/N: NAD1628-UP Air Filter Secondary..... A-5569 Oil Filter Full Flow..... C-1720 304 (EXCAVATORS) S/N: NAD1628-UP Air Filter Secondary..... A-5569 Oil Filter Full Flow..... C-1720		306 (EXCAVATORS) CAT S/N: DCK1-UP Air Filter Primary..... A-8505 Fuel Filter..... FC-1002 Fuel Filter Secondary..... FC-5515 Fuel Filter Secondary..... FC-55151 Fuel Filter..... FC-10022 Fuel Filter..... FC-5516 Oil Filter Full Flow..... C-5510 Oil Filter Full Flow..... C-5522 Oil Filter Full Flow..... C-5505	
301.6C (EXCAVATORS) CAT (S/N: JBB1-UP) , 2006-UP Air Filter Primary..... A-8504		304CR (EXCAVATORS) CAT 3044C (S/N: NAD1-UP) Air Filter Secondary..... A-5569 Oil Filter Full Flow..... C-1011		306 (EXCAVATORS) CAT S/N: MAE1-UP Air Filter Primary..... A-8505 Fuel Filter..... FC-5516 Fuel Filter..... FC-10022 Fuel Filter Secondary..... FC-55151 Fuel Filter Secondary..... FC-5515 Fuel Filter..... FC-10022 Fuel Filter..... FC-55151 Oil Filter Full Flow..... C-5510 Oil Filter Full Flow..... C-5522 Oil Filter Full Flow..... C-5505	
301.8C (EXCAVATORS) CAT S/N: 5DW1-UP , 2008-UP Air Filter Primary..... A-8504 Oil Filter Full Flow..... C-1123 Oil Filter Full Flow..... C-1906		304C (EXCAVATORS) S/N: FPPK1-UP Air Filter Secondary..... A-5569 Oil Filter Full Flow..... C-1720		306 (EXCAVATORS) CAT S/N: MAE1-UP Air Filter Primary..... A-8505 Fuel Filter..... FC-5516 Fuel Filter..... FC-10022 Fuel Filter Secondary..... FC-55151 Fuel Filter Secondary..... FC-5515 Fuel Filter..... FC-1002 Oil Filter Full Flow..... C-5505 Oil Filter Full Flow..... C-5522 Oil Filter Full Flow..... C-5510	
301.8C (EXCAVATORS) CAT S/N: JSB1-UP , 2008-UP Air Filter Primary..... A-8504 Oil Filter Full Flow..... C-1906 Oil Filter Full Flow..... C-1123		305 (EXCAVATORS) S/N: BMW1-UP Air Filter Secondary..... A-5569		306 (EXCAVATORS) CAT S/N: MAE1-UP Air Filter Primary..... A-8505 Fuel Filter..... FC-5516 Fuel Filter..... FC-10022 Fuel Filter Secondary..... FC-55151 Fuel Filter Secondary..... FC-5515 Fuel Filter..... FC-1002 Oil Filter Full Flow..... C-5505 Oil Filter Full Flow..... C-5522 Oil Filter Full Flow..... C-5510	
302 (EXCAVATORS) CAT 3003 (S/N: 3YW1-UP) Hydraulic Oil Filter..... HC-5504 Oil Filter Full Flow..... C-1123 Oil Filter Full Flow..... C-5504		305 (EXCAVATORS) S/N: DGT1-UP Air Filter Secondary..... A-5569 Oil Filter Full Flow..... C-1720		306 (EXCAVATORS) CAT S/N: MAE1-UP Air Filter Primary..... A-8505 Fuel Filter..... FC-5516 Fuel Filter..... FC-10022 Fuel Filter Secondary..... FC-55151 Fuel Filter Secondary..... FC-5515 Fuel Filter..... FC-1002 Oil Filter Full Flow..... C-5505 Oil Filter Full Flow..... C-5522 Oil Filter Full Flow..... C-5510	
302 (EXCAVATORS) CAT 3003 (S/N: BDH1-UP) Oil Filter Full Flow..... C-5504 Oil Filter Full Flow..... C-1123					

Sakura Filter

ENGINE APPLICATION

MODEL/APPLICATION	SAKURA NO	MODEL/APPLICATION	SAKURA NO	MODEL/APPLICATION	SAKURA NO
CATERPILLAR		CATERPILLAR		CATERPILLAR	
307 (EXCAVATORS) L4 3.6L 3600cc 220 CID , 3600		Fuel Filter.....	FC-1002	311 (EXCAVATORS) S/N: 5PK1-UP	
Hydraulic Oil Filter.....	H-5519	Fuel Filter.....	FC-10022	Air Filter Secondary.....	A-5540
307 (EXCAVATORS) L4 4.4L 4400cc 268.5 CID , 4400		307B (EXCAVATORS) w/Mitsubishi 4M40 Eng		Air Filter Primary.....	A-5541
Hydraulic Oil Filter.....	H-5519	Hydraulic Oil Filter.....	H-5519	Air Filter Primary.....	A-5541M
307 (EXCAVATORS) MITSUBISHI 4D32		307C (EXCAVATORS) L4 2.8L 2800cc 173 CID , 2800		Air Filter Set.....	A-5541M-S
Hydraulic Oil Filter.....	HC-9901	Hydraulic Oil Filter.....	H-5519	Air Filter Primary.....	A-76231
307 (EXCAVATORS) S/N: 2MM1-UP		307C (EXCAVATORS) MITSUBISHI 4M40/4M41 (S/N: BCM1-UP)		Cabin Air Filter.....	CA-55850
Air Filter Set.....	A-5541M-S	Air Filter Primary.....	A-8505	Fuel Filter.....	FC-1002
Air Filter Primary.....	A-5541M	Cabin Air Filter.....	CA-55850	Fuel Filter.....	FC-10022
Air Filter Primary.....	A-5541	Fuel Filter.....	FC-10022	Oil Filter Full Flow.....	C-5505
Air Filter Secondary.....	A-5540	Oil Filter Full Flow.....	C-5505	307C (EXCAVATORS) MITSUBISHI 4M40/4M41 (S/N: BNE1-UP)	
Air Filter Primary.....	A-76231	Air Filter Primary.....	A-8505	Air Filter Primary.....	A-8505
Oil Filter Full Flow.....	C-5101	Cabin Air Filter.....	CA-55850	Cabin Air Filter.....	CA-55850
307B (EXCAVATORS) MITSUBISHI M40EA (S/N: AFB-UP)		Fuel Filter.....	FC-10022	Fuel Filter.....	FC-10022
Air Filter Primary.....	A-8505	Fuel Filter.....	FC-1002	Oil Filter Full Flow.....	C-5510
Air Filter Secondary.....	A-8599	Oil Filter Full Flow.....	C-5505	311CU (EXCAVATORS) CAT 3064T	
Cabin Air Filter.....	CA-55850	307C (EXCAVATORS) MITSUBISHI 4M40		Air Filter Set.....	A-4212-S
Fuel Filter.....	FC-10022	Hydraulic Oil Filter.....	HC-9901	Air Filter Secondary.....	A-4211
Fuel Filter.....	FC-1002	307 JA (EXCAVATORS) CAT 3046 (S/N: 2PM1-UP)		Air Filter Primary.....	A-4210
Oil Filter Combination.....	C-5808	Fuel Filter.....	FC-1016	Hydraulic Oil Filter.....	HC-9901
307B (EXCAVATORS) MITSUBISHI 4M40		307L (EXCAVATORS) S/N: 2PM1-UP		311CU (EXCAVATORS) CAT 3064T (S/N: CKE1-UP)	
Hydraulic Oil Filter.....	HC-9901	Fuel Filter.....	FC-1016	Air Filter Set.....	A-5541M-S
307B (EXCAVATORS) S/N: 4RW1-UP		308C (EXCAVATORS) MITSUBISHI 4M40		Air Filter Primary.....	A-5541M
Air Filter Secondary.....	A-8599	Hydraulic Oil Filter.....	HC-9901	Air Filter Primary.....	A-5541
Air Filter Primary.....	A-8505	308C (EXCAVATORS) S/N: KCX1-UP		Air Filter Secondary.....	A-5540
Fuel Filter.....	FC-1002	Air Filter Primary.....	A-8505	Air Filter Primary.....	A-76600
Fuel Filter.....	FC-10022	Air Filter Secondary.....	A-8599	Air Filter Primary.....	A-76231
307B (EXCAVATORS) S/N: 5CW1-UP		Fuel Filter.....	FC-10022	Hydraulic Oil Filter.....	H-7942
Air Filter Primary.....	A-8505	Hydraulic Oil Filter.....	HC-55170	Hydraulic Oil Filter.....	HC-5801
Air Filter Secondary.....	A-8599	Oil Filter Full Flow.....	C-5505	Oil Filter Full Flow.....	C-5510
Fuel Filter.....	FC-10022	311 (EXCAVATORS) CAT 3064T		311CU (EXCAVATORS) CAT 3116 (S/N: CKE01001-UP)	
Fuel Filter.....	FC-1002	Air Filter Primary.....	A-4210	Air Filter Primary.....	A-76600
307B (EXCAVATORS) S/N: 6KZ1-UP		Air Filter Secondary.....	A-4211	Cabin Air Filter.....	CA-55850
Air Filter Secondary.....	A-8599	Air Filter Set.....	A-4212-S	Fuel Filter Secondary.....	FC-5515
Air Filter Primary.....	A-8505	Hydraulic Oil Filter.....	HC-9901	Fuel Filter Secondary.....	FC-55151
Fuel Filter.....	FC-1002	311 (EXCAVATORS) CAT 3064 (S/N: 9LJ1-UP)		Fuel Filter.....	FC-5516
Fuel Filter.....	FC-10022	Air Filter Primary.....	A-6008	Hydraulic Oil Filter.....	H-7942
307B (EXCAVATORS) S/N: 7DZ1-UP		Air Filter Secondary.....	A-5627	Hydraulic Oil Filter.....	HC-5801
Air Filter Primary.....	A-8505	Air Filter Set.....	A-5663-S	Oil Filter Full Flow.....	C-5510
Air Filter Secondary.....	A-8599	Fuel Filter.....	FC-1010	311CU (EXCAVATORS) CAT 3116 (S/N: CKE1-UP)	
Fuel Filter.....	FC-10022	Oil Filter Combination.....	C-7916	Air Filter Primary.....	A-76600
Fuel Filter.....	FC-1002	Oil Filter Full Flow.....	C-5510	Air Filter Secondary.....	A-5540
307B (EXCAVATORS) S/N: AFB1-UP		311 (EXCAVATORS) S/N: 5PK1-UP		Air Filter Primary.....	A-5541
Air Filter Secondary.....	A-8599	Air Filter Secondary.....	A-5541M	Air Filter Primary.....	A-5541M
Air Filter Primary.....	A-8505	Air Filter Set.....	A-5663-S	Air Filter Primary.....	A-76231

MODEL/APPLICATION	SAKURA NO	MODEL/APPLICATION	SAKURA NO	MODEL/APPLICATION	SAKURA NO
CATERPILLAR		CATERPILLAR		CATERPILLAR	
311CU (EXCAVATORS) CAT 3116 (S/N: CKE1-UP)		Hydraulic Oil Filter.....	HC-9901	Hydraulic Oil Filter.....	H-5522
Fuel Filter Secondary.....	FC-55151	312 (EXCAVATORS) CAT 3064 (S/N: 6BL1-UP)		Hydraulic Oil Filter.....	HC-5801
Hydraulic Oil Filter.....	HC-5801	Air Filter Secondary.....	A-5540	Oil Filter Full Flow.....	C-5510
Hydraulic Oil Filter.....	H-7942	Oil Filter Full Flow.....	C-5102	312C (EXCAVATORS) CAT 3064 (S/N: CBA01201-UP)	
Oil Filter Full Flow.....	C-5510	312 (EXCAVATORS) CAT 3064 (S/N: 6GK1-UP)		Air Filter Primary.....	A-76600
311B (EXCAVATORS) CAT 3064T		Air Filter Set.....	A-5663-S	Cabin Air Filter.....	CA-55850
Hydraulic Oil Filter.....	HC-9901	Air Filter Primary.....	A-5627	Fuel Filter Secondary.....	FC-55151
311B (EXCAVATORS) CAT 3064 (S/N: 2LS1-UP)		Air Filter Secondary.....	A-6008	Fuel Filter.....	FC-5516
Air Filter Secondary.....	A-5540	Fuel Filter.....	FC-1010	Fuel Filter Secondary.....	FC-5515
Air Filter Primary.....	A-5541	Oil Filter Full Flow.....	C-5510	Hydraulic Oil Filter.....	HC-5801
Air Filter Primary.....	A-5541M	Oil Filter Combination.....	C-7916	Hydraulic Oil Filter.....	H-7942
Air Filter Set.....	A-5541M-S	312 (EXCAVATORS) S/N: 6GK1-UP		Oil Filter Full Flow.....	C-5510
Air Filter Primary.....	A-76231	Air Filter Set.....	A-5663-S	312C (EXCAVATORS) CAT 3064 (S/N: CBA1-UP)	
Fuel Filter.....	FC-1010	Air Filter Secondary.....	A-6008	Air Filter Primary.....	A-76600
Hydraulic Oil Filter.....	H-7942	Air Filter Primary.....	A-76231	Air Filter Set.....	A-5541M-S
Hydraulic Oil Filter.....	HC-5801	Air Filter Primary.....	A-5627	Air Filter Primary.....	A-76231
Oil Filter Full Flow.....	C-5510	Air Filter Secondary.....	A-5540	Air Filter Secondary.....	A-5540
311B (EXCAVATORS) CAT 3064 (S/N: 8GR1-UP)		Air Filter Set.....	A-5541M-S	Air Filter Primary.....	A-5541
Air Filter Primary.....	A-76231	Air Filter Primary.....	A-5541M	Air Filter Primary.....	A-5541M
Air Filter Set.....	A-5541M-S	Air Filter Primary.....	A-5541	Cabin Air Filter.....	CA-55850
Air Filter Primary.....	A-5541M	Oil Filter Combination.....	C-7916	Fuel Filter Secondary.....	FC-5515
Air Filter Primary.....	A-5541	312 (EXCAVATORS) S/N: 7DK1-UP		Fuel Filter.....	FC-5516
Air Filter Secondary.....	A-5540	Air Filter Primary.....	A-5541	Fuel Filter Secondary.....	FC-55151
Fuel Filter.....	FC-1010	Air Filter Primary.....	A-5541M	Hydraulic Oil Filter.....	H-7942
Hydraulic Oil Filter.....	HC-5801	Air Filter Set.....	A-5541M-S	Hydraulic Oil Filter.....	HC-5801
Hydraulic Oil Filter.....	H-7942	Air Filter Secondary.....	A-5540	Oil Filter Full Flow.....	C-5510
Oil Filter Full Flow.....	C-5510	Air Filter Primary.....	A-76231	312C (EXCAVATORS) CAT 3064 (S/N: CBT1-UP)	
311D (EXCAVATORS) CAT C4.2 ACERT , 4200		Cabin Air Filter.....	CA-55850	Air Filter Secondary.....	A-5540
Air Filter Primary.....	A-4210	3126 (ENGINES) S/N: 6GK1-UP		Hydraulic Oil Filter.....	H-7942
Air Filter Secondary.....	A-4211	Fuel Filter Secondary.....	FC-5504	Hydraulic Oil Filter.....	HC-5801
Air Filter Set.....	A-4212-S	Fuel Filter Secondary.....	FC-5515	Oil Filter Full Flow.....	C-5102
311D (EXCAVATORS) CAT C4.2 ACERT		Fuel Filter Secondary.....	FC-55151	312C (EXCAVATORS) CAT 3064 (S/N: FDS1-UP)	
Hydraulic Oil Filter.....	HC-9901	Fuel Filter.....	FC-5516	Air Filter Primary.....	A-76600
311C (EXCAVATORS) CAT 3064T		Oil Filter Full Flow.....	C-5510	Air Filter Primary.....	A-76231
Air Filter Set.....	A-4212-S	312C (EXCAVATORS) CAT 3064T		Air Filter Set.....	A-5541M-S
Air Filter Secondary.....	A-4211	Air Filter Primary.....	A-4210	Air Filter Secondary.....	A-5540
Air Filter Primary.....	A-4210	Air Filter Secondary.....	A-4211	Air Filter Primary.....	A-5541M
Hydraulic Oil Filter.....	HC-9901	Air Filter Set.....	A-4212-S	Air Filter Primary.....	A-5541
311C (EXCAVATORS) CAT 3064 (S/N: CKE01001-UP)		Hydraulic Oil Filter.....	HC-9901	Cabin Air Filter.....	CA-55850
Air Filter Primary.....	A-76600	312C (EXCAVATORS) CAT 3064 (S/N: BNN1-UP)		Fuel Filter Secondary.....	FC-5515
Cabin Air Filter.....	CA-55850	Air Filter Secondary.....	A-5540	Fuel Filter Secondary.....	FC-55151
Fuel Filter.....	FC-5516	Hydraulic Oil Filter.....	H-7942	Fuel Filter.....	FC-5516
Fuel Filter Secondary.....	FC-55151	Hydraulic Oil Filter.....	HC-5801	Hydraulic Oil Filter.....	H-7942
Fuel Filter Secondary.....	FC-5515	Oil Filter Full Flow.....	C-5102	Hydraulic Oil Filter.....	HC-5801
Hydraulic Oil Filter.....	HC-5801	312C (EXCAVATORS) CAT 3064 (S/N: BWH1-UP)		Oil Filter Full Flow.....	C-5510
Hydraulic Oil Filter.....	H-7942	Air Filter Secondary.....	A-5540	312C L (EXCAVATORS) CAT 3064T	
Oil Filter Full Flow.....	C-5510	Hydraulic Oil Filter.....	H-7942	Air Filter Set.....	A-4212-S
312 (EXCAVATORS) CAT 3064T		Hydraulic Oil Filter.....	HC-5801	Air Filter Secondary.....	A-4211
Air Filter Secondary.....	A-5540	Oil Filter Full Flow.....	C-5102	Air Filter Primary.....	A-4210
Hydraulic Oil Filter.....	H-7942	312C (EXCAVATORS) CAT 3064 (S/N: CBA1-UP)		Hydraulic Oil Filter.....	HC-9901
Hydraulic Oil Filter.....	HC-5801	Air Filter Secondary.....	A-5540	312C L (EXCAVATORS) CAT 3064 (S/N: CBA1-UP)	
Oil Filter Full Flow.....	C-5510	Cabin Air Filter.....	CA-55850	Air Filter Set.....	A-5541M-S
312 (EXCAVATORS) CAT 3064T		Fuel Filter Secondary.....	FC-5515	Air Filter Secondary.....	A-4212-S
Air Filter Secondary.....	A-5540	Fuel Filter.....	FC-5516	Air Filter Primary.....	A-4210
Hydraulic Oil Filter.....	H-7942	Fuel Filter Secondary.....	FC-55151	Hydraulic Oil Filter.....	HC-9901
Hydraulic Oil Filter.....	HC-5801	312C L (EXCAVATORS) CAT 3064 (S/N: CBA1-UP)		312C L (EXCAVATORS) CAT 3064 (S/N: CBA1-UP)	
Oil Filter Full Flow.....	C-5510	Air Filter Secondary.....	A-5540	Air Filter Set.....	A-5541M-S
312 (EXCAVATORS) CAT 3064T		Cabin Air Filter.....	CA-55850	Air Filter Secondary.....	A-4212-S
Air Filter Secondary.....	A-5540	Fuel Filter Secondary.....	FC-5515	Air Filter Primary.....	A-4210
Hydraulic Oil Filter.....	H-7942	Fuel Filter.....	FC-5516	Hydraulic Oil Filter.....	HC-9901
Hydraulic Oil Filter.....	HC-5801	Fuel Filter Secondary.....	FC-55151	312C L (EXCAVATORS) CAT 3064 (S/N: CBA1-UP)	
Oil Filter Full Flow.....	C-5510	312C L (EXCAVATORS) CAT 3064 (S/N: CBA1-UP)		Air Filter Set.....	A-5541M-S
312 (EXCAVATORS) CAT 3064T		Air Filter Secondary.....	A-5540	Air Filter Secondary.....	A-4212-S
Air Filter Secondary.....	A-5540	Cabin Air Filter.....	CA-55850	Air Filter Primary.....	A-4210
Hydraulic Oil Filter.....	H-7942	Fuel Filter Secondary.....	FC-5515	Hydraulic Oil Filter.....	HC-9901
Hydraulic Oil Filter.....	HC-5801	Fuel Filter.....	FC-5516	312C L (EXCAVATORS) CAT 3064 (S/N: CBA1-UP)	
Oil Filter Full Flow.....	C-5510	Fuel Filter Secondary.....	FC-55151	Air Filter Set.....	A-5541M-S
312 (EXCAVATORS) CAT 3064T		312C L (EXCAVATORS) CAT 3064 (S/N: CBA1-UP)		Air Filter Secondary.....	A-4212-S
Air Filter Secondary.....	A-5540	Air Filter Secondary.....	A-5540	Air Filter Primary.....	A-4210
Hydraulic Oil Filter.....	H-7942	Cabin Air Filter.....	CA-55850	Hydraulic Oil Filter.....	HC-9901
Hydraulic Oil Filter.....	HC-5801	Fuel Filter Secondary.....	FC-5515	312C L (EXCAVATORS) CAT 3064 (S/N: CBA1-UP)	
Oil Filter Full Flow.....	C-5510	Fuel Filter.....	FC-5516	Air Filter Set.....	A-5541M-S
312 (EXCAVATORS) CAT 3064T		Fuel Filter Secondary.....	FC-55151	Air Filter Secondary.....	A-4212-S
Air Filter Secondary.....	A-5540	312C L (EXCAVATORS) CAT 3064 (S/N: CBA1-UP)		Air Filter Primary.....	A-4210
Hydraulic Oil Filter.....	H-7942	Air Filter Secondary.....	A-5540	Hydraulic Oil Filter.....	HC-9901
Hydraulic Oil Filter.....	HC-5801	Cabin Air Filter.....	CA-55850	312C L (EXCAVATORS) CAT 3064 (S/N: CBA1-UP)	
Oil Filter Full Flow.....	C-5510	Fuel Filter Secondary.....	FC-5515	Air Filter Set.....	A-5541M-S
312 (EXCAVATORS) CAT 3064T		Fuel Filter.....	FC-5516	Air Filter Secondary.....	A-4212-S
Air Filter Secondary.....	A-5540	Fuel Filter Secondary.....	FC-55151	Air Filter Primary.....	A-4210
Hydraulic Oil Filter.....	H-7942	312C L (EXCAVATORS) CAT 3064 (S/N: CBA1-UP)		Hydraulic Oil Filter.....	HC-9901
Hydraulic Oil Filter.....	HC-5801	Air Filter Secondary.....	A-5540	312C L (EXCAVATORS) CAT 3064 (S/N: CBA1-UP)	
Oil Filter Full Flow.....	C-5510	Cabin Air Filter.....	CA-55850	Air Filter Set.....	A-5541M-S
312 (EXCAVATORS) CAT 3064T		Fuel Filter Secondary.....	FC-5515	Air Filter Secondary.....	A-4212-S
Air Filter Secondary.....	A-5540	Fuel Filter.....	FC-5516	Air Filter Primary.....	A-4210
Hydraulic Oil Filter.....	H-7942	Fuel Filter Secondary.....	FC-55151	Hydraulic Oil Filter.....	HC-9901
Hydraulic Oil Filter.....	HC-5801	312C L (EXCAVATORS) CAT 3064 (S/N: CBA1-UP)		312C L (EXCAVATORS) CAT 3064 (S/N: CBA1-UP)	
Oil Filter Full Flow.....	C-5510	Air Filter Secondary.....	A-5540	Air Filter Set.....	A-5541M-S

MODEL/APPLICATION	SAKURA NO
CATERPILLAR	
312C L (EXCAVATORS) CAT 3064 (S/N: CBA1-UP)	
Air Filter Primary.....	A-5541M
Air Filter Primary.....	A-5541
Air Filter Secondary.....	A-5540
Air Filter Primary.....	A-76600
Air Filter Primary.....	A-76231
Fuel Filter Secondary.....	FC-5515
Fuel Filter Secondary.....	FC-55151
Fuel Filter.....	FC-5516
Hydraulic Oil Filter.....	H-7942
Hydraulic Oil Filter.....	HC-5801
Oil Filter Full Flow.....	C-5510
312C L (EXCAVATORS) CAT 3064 (S/N: CBT1-UP)	
Air Filter Secondary.....	A-5540
Hydraulic Oil Filter.....	HC-5801
Hydraulic Oil Filter.....	H-7942
Oil Filter Full Flow.....	C-5102
312C L (EXCAVATORS) CAT 3064 (S/N: DBN1-UP)	
Air Filter Secondary.....	A-5540
Cabin Air Filter.....	CA-55850
Fuel Filter.....	FC-5516
Fuel Filter Secondary.....	FC-55151
Fuel Filter Secondary.....	FC-5515
Hydraulic Oil Filter.....	HC-5801
Hydraulic Oil Filter.....	H-5522
Oil Filter Full Flow.....	C-5510
312C L (EXCAVATORS) CAT 3064 (S/N: FDS1-UP)	
Air Filter Set.....	A-5541M-S
Air Filter Primary.....	A-76231
Air Filter Primary.....	A-76600
Air Filter Secondary.....	A-5540
Air Filter Primary.....	A-5541
Air Filter Primary.....	A-5541M
Fuel Filter Secondary.....	FC-5515
Fuel Filter Secondary.....	FC-55151
Fuel Filter.....	FC-5516
Hydraulic Oil Filter.....	HC-5801
Hydraulic Oil Filter.....	H-7942
Oil Filter Full Flow.....	C-5510
Oil Filter Full Flow.....	C-5102
312C L (EXCAVATORS) S/N: BNN1-UP	
Air Filter Set.....	A-5541M-S
Air Filter Primary.....	A-5541M
Air Filter Primary.....	A-5541
Air Filter Secondary.....	A-5540
Air Filter Primary.....	A-76231
Hydraulic Oil Filter.....	H-7942
Hydraulic Oil Filter.....	HC-5801
Oil Filter Full Flow.....	C-5102
312B (EXCAVATORS) CAT 3064T	
Hydraulic Oil Filter.....	HC-9901

MODEL/APPLICATION	SAKURA NO
CATERPILLAR	
312B (EXCAVATORS) CAT 3064 (S/N: 2KW1-UP)	
Air Filter Secondary.....	A-5540
Hydraulic Oil Filter.....	HC-5801
Hydraulic Oil Filter.....	H-7942
Oil Filter Full Flow.....	C-5102
312B (EXCAVATORS) CAT 3064 (S/N: 2NS1-UP)	
Air Filter Secondary.....	A-5540
Air Filter Primary.....	A-5541
Air Filter Primary.....	A-5541M
Air Filter Set.....	A-5541M-S
Air Filter Primary.....	A-76231
Fuel Filter.....	FC-1010
Hydraulic Oil Filter.....	H-7942
Hydraulic Oil Filter.....	HC-5801
Oil Filter Full Flow.....	C-5510
312B (EXCAVATORS) CAT 3064 (S/N: 3FS1-UP)	
Air Filter Primary.....	A-76231
Air Filter Set.....	A-5541M-S
Air Filter Primary.....	A-5541M
Air Filter Primary.....	A-5541
Air Filter Secondary.....	A-5540
Fuel Filter.....	FC-1010
Hydraulic Oil Filter.....	H-7942
Hydraulic Oil Filter.....	HC-5801
Oil Filter Full Flow.....	C-5510
312B (EXCAVATORS) CAT 3064 (S/N: 6SW1-UP)	
Air Filter Secondary.....	A-5540
Hydraulic Oil Filter.....	H-7942
Hydraulic Oil Filter.....	HC-5801
Oil Filter Full Flow.....	C-5102
312B (EXCAVATORS) CAT 3064 (S/N: 8JR1-UP)	
Air Filter Secondary.....	A-5540
Air Filter Primary.....	A-5541
Air Filter Primary.....	A-5541M
Air Filter Set.....	A-5541M-S
Air Filter Primary.....	A-76231
Fuel Filter.....	FC-1010
Hydraulic Oil Filter.....	H-7942
Hydraulic Oil Filter.....	HC-5801
Oil Filter Full Flow.....	C-5510
312B (EXCAVATORS) CAT 3064 (S/N: 9FS1-UP)	
Air Filter Secondary.....	A-5540
Hydraulic Oil Filter.....	H-7942
Hydraulic Oil Filter.....	HC-5801
Oil Filter Full Flow.....	C-5102
312B (EXCAVATORS) CAT 3064 (S/N: 9GR1-UP)	
Air Filter Secondary.....	A-5540
Air Filter Primary.....	A-76231
Air Filter Set.....	A-5541M-S
Air Filter Primary.....	A-5541M
Air Filter Primary.....	A-5541

MODEL/APPLICATION	SAKURA NO
CATERPILLAR	
Fuel Filter.....	FC-1010
Hydraulic Oil Filter.....	H-7942
Hydraulic Oil Filter.....	HC-5801
Oil Filter Full Flow.....	C-5102
Oil Filter Full Flow.....	C-5510
312D (EXCAVATORS) CAT C4.2 ACERT , 4200	
Air Filter Primary.....	A-4210
Air Filter Secondary.....	A-4211
Air Filter Set.....	A-4212-S
312D (EXCAVATORS) CAT C4.2 ACERT	
Hydraulic Oil Filter.....	HC-9901
312B L (EXCAVATORS) CAT 3054T	
Hydraulic Oil Filter.....	HC-9901
312B L (EXCAVATORS) CAT 3064 (S/N: 2KW1-UP)	
Air Filter Set.....	A-5541M-S
Air Filter Primary.....	A-5541M
Air Filter Primary.....	A-5541
Air Filter Secondary.....	A-5540
Air Filter Primary.....	A-76231
Fuel Filter.....	FC-1010
Hydraulic Oil Filter.....	H-7942
Oil Filter Full Flow.....	C-5102
Oil Filter Full Flow.....	C-5510
312B L (EXCAVATORS) CAT 3064 (S/N: 3FS1-UP)	
Air Filter Set.....	A-5541M-S
Air Filter Primary.....	A-76231
Air Filter Secondary.....	A-5540
Air Filter Primary.....	A-5541
Air Filter Primary.....	A-5541M
Fuel Filter.....	FC-1010
Hydraulic Oil Filter.....	HC-5801
Hydraulic Oil Filter.....	H-7942
Oil Filter Full Flow.....	C-5510
312B L (EXCAVATORS) CAT 3064 (S/N: 6SW1-UP)	
Air Filter Secondary.....	A-5540
Hydraulic Oil Filter.....	H-7942
Hydraulic Oil Filter.....	HC-5801
Oil Filter Full Flow.....	C-5102
312B L (EXCAVATORS) CAT 3064 (S/N: 8JR1-UP)	
Air Filter Set.....	A-5541M-S
Air Filter Secondary.....	A-5540
Air Filter Primary.....	A-76231
Air Filter Primary.....	A-5541M
Air Filter Primary.....	A-5541
Fuel Filter.....	FC-1010
Hydraulic Oil Filter.....	HC-5801
Hydraulic Oil Filter.....	H-7942
Oil Filter Full Flow.....	C-5510
312B L (EXCAVATORS) CAT 3064 (S/N: 9FS1-UP)	
Air Filter Secondary.....	A-5540

MODEL/APPLICATION	SAKURA NO
CATERPILLAR	
312B L (EXCAVATORS) CAT 3064 (S/N: 9FS1-UP)	
Hydraulic Oil Filter.....	H-7942
Hydraulic Oil Filter.....	HC-5801
Oil Filter Full Flow.....	C-5102
312B L (EXCAVATORS) CAT 3064 (S/N: 9GR1-UP)	
Air Filter Secondary.....	A-5540
Air Filter Primary.....	A-76231
Air Filter Primary.....	A-5541
Air Filter Primary.....	A-5541M
Air Filter Set.....	A-5541M-S
Fuel Filter.....	FC-1010
Hydraulic Oil Filter.....	HC-5801
Hydraulic Oil Filter.....	H-7942
Oil Filter Full Flow.....	C-5510
312B L (EXCAVATORS) CAT 3064 (S/N: 9NW1-UP)	
Air Filter Secondary.....	A-5540
Hydraulic Oil Filter.....	H-7942
Hydraulic Oil Filter.....	HC-5801
Oil Filter Full Flow.....	C-5102
312L (EXCAVATORS) S/N: 6GK425-UP	
Air Filter Secondary.....	A-6008
Air Filter Set.....	A-5663-S
Air Filter Primary.....	A-5627
Oil Filter Combination.....	C-7916
312D2 (EXCAVATORS) CAT 3054C	
Air Filter Set.....	A-4212-S
Air Filter Secondary.....	A-4211
Air Filter Primary.....	A-4210
Hydraulic Oil Filter.....	HC-9901
312D2 (EXCAVATORS) w/3054C Eng.	
Fuel/Water Separator.....	SFC-43040
312D2 GC (EXCAVATORS) CAT 3054C	
Air Filter Primary.....	A-4210
Air Filter Secondary.....	A-4211
Air Filter Set.....	A-4212-S
Hydraulic Oil Filter.....	HC-9901
312D2 GC (EXCAVATORS) w/3054C Eng.	
Fuel/Water Separator.....	SFC-43040
312D2 L (EXCAVATORS) CAT 3054C	
Air Filter Set.....	A-4212-S
Air Filter Secondary.....	A-4211
Air Filter Primary.....	A-4210
Hydraulic Oil Filter.....	HC-9901
312D2 L (EXCAVATORS) w/3054C Eng.	
Fuel/Water Separator.....	SFC-43040

MODEL/APPLICATION	SAKURA NO
CATERPILLAR	
313B (EXCAVATORS) MITSUBISHI 4D34-TE1	
Air Filter Primary.....	AS-7989
Air Filter Set.....	AS-7989-S
Hydraulic Oil Filter.....	HC-9901
313B CR (EXCAVATORS) CAT 3054 (S/N: BAS1-UP)	
Fuel Filter.....	FC-1002
Fuel Filter.....	FC-10022
313B CR (EXCAVATORS) MITSUBISHI 4D34-TE1	
Hydraulic Oil Filter.....	HC-9901
313D2 (EXCAVATORS) w/3054C Eng.	
Fuel/Water Separator.....	SFC-43040
314C (EXCAVATORS) CAT 3064T	
Hydraulic Oil Filter.....	HC-9901
314C (EXCAVATORS) CAT 3064 (S/N: KJA1-UP)	
Air Filter Secondary.....	A-5540
Air Filter Primary.....	A-5541
Air Filter Primary.....	A-5541M
Air Filter Set.....	A-5541M-S
Air Filter Primary.....	A-76231
Fuel Filter.....	FC-5516
Fuel Filter Secondary.....	FC-55151
Fuel Filter Secondary.....	FC-5515
Hydraulic Oil Filter.....	H-7942
Hydraulic Oil Filter.....	HC-5801
Oil Filter Full Flow.....	C-5510
314C (EXCAVATORS) CAT 3064 (S/N: PCA1-UP)	
Air Filter Primary.....	A-76231
Air Filter Set.....	A-5541M-S
Air Filter Primary.....	A-5541M
Air Filter Primary.....	A-5541
Air Filter Secondary.....	A-5540
Fuel Filter Secondary.....	FC-5515
Fuel Filter Secondary.....	FC-55151
Fuel Filter.....	FC-5516
Hydraulic Oil Filter.....	HC-5801
Hydraulic Oil Filter.....	H-7942
Oil Filter Full Flow.....	C-5510
314C CR (EXCAVATORS) CAT 3064T	
Hydraulic Oil Filter.....	HC-9901
314C CR (EXCAVATORS) CAT 3145 (S/N: KJA1-UP)	
Air Filter Primary.....	A-5541M
Air Filter Primary.....	A-5541
Air Filter Secondary.....	A-5540
Air Filter Primary.....	A-76231
Air Filter Set.....	A-5541M-S
Fuel Filter Secondary.....	FC-5515
Fuel Filter Secondary.....	FC-55151
Fuel Filter.....	FC-5516

MODEL/APPLICATION	SAKURA NO
CATERPILLAR	
Hydraulic Oil Filter.....	H-7942
Hydraulic Oil Filter.....	HC-5801
Oil Filter Full Flow.....	C-5510
314C CR (EXCAVATORS) CAT 3145 (S/N: PCA1-UP)	
Air Filter Set.....	A-5541M-S
Air Filter Primary.....	A-76231
Air Filter Secondary.....	A-5540
Air Filter Primary.....	A-5541
Air Filter Primary.....	A-5541M
Fuel Filter Secondary.....	FC-55151
Fuel Filter Secondary.....	FC-5515
Fuel Filter.....	FC-5516
Hydraulic Oil Filter.....	HC-5801
Hydraulic Oil Filter.....	H-7942
Oil Filter Full Flow.....	C-5510
315C (EXCAVATORS) CAT 3054 (S/N: AKE1-UP)	
Air Filter Secondary.....	A-2705
Air Filter Primary.....	A-2706
Cabin Air Filter.....	CA-55850
Fuel Filter.....	FC-5516
Fuel Filter Secondary.....	FC-55151
Fuel Filter Secondary.....	FC-5515
Hydraulic Oil Filter.....	H-7942
Hydraulic Oil Filter.....	HC-5801
Oil Filter Full Flow.....	C-5510
315C (EXCAVATORS) CAT 3054 (S/N: CFB1-UP)	
Air Filter Secondary.....	A-8578
Air Filter Primary.....	A-2706
Air Filter Primary.....	AS-8577
Air Filter Secondary.....	A-2705
Fuel Filter Secondary.....	FC-5515
Fuel Filter Secondary.....	FC-55151
Fuel Filter.....	FC-5516
Hydraulic Oil Filter.....	HC-5801
Hydraulic Oil Filter.....	H-7942
Oil Filter Full Flow.....	C-5510
315C (EXCAVATORS) CAT 3054 (S/N: CFT1-UP)	
Air Filter Secondary.....	A-2705
Air Filter Primary.....	AS-8577
Air Filter Primary.....	A-2706
Air Filter Secondary.....	A-8578
Cabin Air Filter.....	CA-55850
Fuel Filter.....	FC-5516
Fuel Filter Secondary.....	FC-55151
Fuel Filter Secondary.....	FC-5515
Hydraulic Oil Filter.....	H-7942
Hydraulic Oil Filter.....	HC-5801
Oil Filter Full Flow.....	C-5510
315C (EXCAVATORS) CAT 3046	
Air Filter Secondary.....	A-4402
Oil Filter Full Flow.....	C-6218
315C (EXCAVATORS) CAT 3046 T	
Hydraulic Oil Filter.....	HC-9901

MODEL/APPLICATION	SAKURA NO	MODEL/APPLICATION	SAKURA NO	MODEL/APPLICATION	SAKURA NO
CATERPILLAR		CATERPILLAR		CATERPILLAR	
315C (EXCAVATORS) CAT 3046 T		Oil Filter Full Flow.....	C-5102	Fuel Filter.....	FC-1010
315C L (EXCAVATORS) CAT 3150 (S/N: ANF1-UP)		315 (EXCAVATORS) CAT 3046 T		Oil Filter Full Flow.....	C-5504
Air Filter Secondary.....	A-8670	Hydraulic Oil Filter.....	HC-9901	315L (EXCAVATORS) CAT 3150 (S/N: 6YM1-UP)	
Air Filter Primary.....	A-5673	315B (EXCAVATORS) CAT 3046 (S/N: 5SW1-UP)		Air Filter Primary.....	A-5627
Air Filter Set.....	A-5675-S	Air Filter Secondary.....	A-5540	Air Filter Secondary.....	A-6008
Cabin Air Filter.....	CA-55850	Air Filter Primary.....	A-5541	Air Filter Set.....	A-5663-S
Hydraulic Oil Filter.....	H-5522	Air Filter Primary.....	A-5541M	Cabin Air Filter.....	CA-55850
Hydraulic Oil Filter.....	HC-5801	Air Filter Set.....	A-5541M-S	Fuel Filter.....	FC-1010
Oil Filter Full Flow.....	C-5510	Air Filter Primary.....	A-76231	Oil Filter Full Flow.....	C-5504
315C L (EXCAVATORS) CAT 3150 (S/N: CFB1-UP)		Hydraulic Oil Filter.....	HC-5801	315L (EXCAVATORS) CAT 3046 T	
Air Filter Secondary.....	A-8578	Hydraulic Oil Filter.....	H-7942	Hydraulic Oil Filter.....	HC-9901
Air Filter Primary.....	AS-8577	Oil Filter Full Flow.....	C-5102	315C L ANF1 (EXCAVATORS) CAT 3150	
Air Filter Secondary.....	A-2705	315B (EXCAVATORS) CAT 3046 T		Air Filter Primary.....	A-56731
Air Filter Primary.....	A-2706	Hydraulic Oil Filter.....	HC-9901	Air Filter Set.....	A-56731-S
Cabin Air Filter.....	CA-55850	315B (EXCAVATORS) S/N: 1SW1-UP		Air Filter Secondary.....	A-56741
Fuel Filter.....	FC-5516	Air Filter Secondary.....	A-2705	315D L (EXCAVATORS) CAT C4.2 , 4200, 2011	
Fuel Filter Secondary.....	FC-5515	Air Filter Primary.....	A-2706	Air Filter Set.....	A-56731-S
Fuel Filter Secondary.....	FC-55151	Fuel Filter.....	FC-1010	Air Filter Primary.....	A-56731
Hydraulic Oil Filter.....	HC-5801	Hydraulic Oil Filter.....	H-7942	315D L (EXCAVATORS) CAT C4.2 , 2011	
Hydraulic Oil Filter.....	H-7942	Hydraulic Oil Filter.....	HC-5801	Air Filter Secondary.....	A-56741
Oil Filter Full Flow.....	C-5510	Oil Filter Full Flow.....	C-5504	315D L (EXCAVATORS) CAT C4.2	
315C L (EXCAVATORS) CAT 3150 (S/N: CFT1-UP)		315B (EXCAVATORS) S/N: 3AW1-UP		Hydraulic Oil Filter.....	HC-9901
Air Filter Primary.....	A-2706	Air Filter Primary.....	A-2706	317 (EXCAVATORS) CAT 3046 (S/N: 4MM1-UP)	
Air Filter Secondary.....	A-2705	Air Filter Secondary.....	A-2705	Air Filter Secondary.....	A-5540
Air Filter Primary.....	AS-8577	Fuel Filter.....	FC-1010	Oil Filter Full Flow.....	C-5101
Air Filter Secondary.....	A-8578	Hydraulic Oil Filter.....	HC-5801	317 (EXCAVATORS) CAT 3046 T	
Cabin Air Filter.....	CA-55850	Hydraulic Oil Filter.....	H-7942	Hydraulic Oil Filter.....	HC-9901
Fuel Filter Secondary.....	FC-55151	Oil Filter Full Flow.....	C-5504	317B (EXCAVATORS) CAT S/N: 5XK484-9970-UP	
Fuel Filter Secondary.....	FC-5515	315D (EXCAVATORS) CAT C4.2 ACERT		Air Filter Primary.....	A-2706
Fuel Filter.....	FC-5516	Hydraulic Oil Filter.....	HC-9901	Air Filter Secondary.....	A-2705
Hydraulic Oil Filter.....	H-7942	315 M (EXCAVATORS)		Cabin Air Filter.....	CA-55850
Hydraulic Oil Filter.....	HC-5801	Air Filter Set.....	A-5541M-S	Fuel Filter.....	FC-1010
Oil Filter Full Flow.....	C-5510	Air Filter Primary.....	A-5541M	Hydraulic Oil Filter.....	HC-5801
315C L (EXCAVATORS) CAT 3150 (S/N: CJC1-UP)		Air Filter Primary.....	A-5541	Hydraulic Oil Filter.....	H-7942
Air Filter Secondary.....	A-2705	Air Filter Secondary.....	A-5540	Oil Filter Full Flow.....	C-5504
Air Filter Primary.....	A-2706	Air Filter Primary.....	A-76231	317B (EXCAVATORS) CAT S/N: 5XK9971-UP	
Cabin Air Filter.....	CA-55850	315L (EXCAVATORS) CAT 3150 (S/N: 4YM1-UP)		Air Filter Secondary.....	A-2705
Fuel Filter.....	FC-5516	Air Filter Primary.....	A-5627	Air Filter Primary.....	A-2706
Fuel Filter Secondary.....	FC-5515	Air Filter Secondary.....	A-6008	Cabin Air Filter.....	CA-55850
Fuel Filter Secondary.....	FC-55151	Air Filter Set.....	A-5663-S	Fuel Filter.....	FC-1010
Hydraulic Oil Filter.....	HC-5801	Cabin Air Filter.....	CA-55850	Hydraulic Oil Filter.....	HC-5801
Hydraulic Oil Filter.....	H-7942	Fuel Filter.....	FC-1010	Hydraulic Oil Filter.....	H-7942
Oil Filter Full Flow.....	C-5510	Oil Filter Full Flow.....	C-5504	Hydraulic Oil Filter.....	HC-5801
315C L (EXCAVATORS) CAT 3046 T		315L (EXCAVATORS) CAT 3150 (S/N: 5XK1-UP)		Oil Filter Full Flow.....	C-5504
Hydraulic Oil Filter.....	HC-9901	Air Filter Set.....	A-5663-S	317B (EXCAVATORS) CAT S/N: 6DZ1-UP	
315C L (EXCAVATORS) w/3054 Eng.		Air Filter Secondary.....	A-6008	Air Filter Primary.....	A-2706
Fuel/Water Separator.....	SFC-43040	Air Filter Primary.....	A-5627	Air Filter Secondary.....	A-2705
315 (EXCAVATORS) CAT 3046 (S/N: 3ZM1-UP)		Cabin Air Filter.....	CA-55850	317B (EXCAVATORS) CAT S/N: 6DZ1-UP	
Air Filter Secondary.....	A-5540	315L (EXCAVATORS) CAT 3150 (S/N: 5XK1-UP)		Air Filter Primary.....	A-2706
		Air Filter Set.....	A-5663-S	Air Filter Secondary.....	A-2705
		Air Filter Secondary.....	A-6008		
		Air Filter Primary.....	A-5627		
		Cabin Air Filter.....	CA-55850		

Sakura Filter

ENGINE APPLICATION

MODEL/APPLICATION	SAKURA NO	MODEL/APPLICATION	SAKURA NO	MODEL/APPLICATION	SAKURA NO
CATERPILLAR		CATERPILLAR		CATERPILLAR	
317B (EXCAVATORS) CAT S/N: 6DZ1-UP		Fuel Filter Secondary.....	FC-5515	Air Filter Primary.....	A-2706
Cabin Air Filter.....	CA-55850	Oil Filter Full Flow.....	C-5510	Fuel Filter.....	FC-5516
Fuel Filter.....	FC-1010	318C (EXCAVATORS) CAT 3066 , 2012		Fuel Filter Secondary.....	FC-55151
Hydraulic Oil Filter.....	HC-5801	Air Filter Set.....	A-56731-S	Fuel Filter Secondary.....	FC-5515
Hydraulic Oil Filter.....	H-7942	Air Filter Secondary.....	A-56741	Fuel Filter Secondary.....	FC-55151
Oil Filter Full Flow.....	C-5504	Air Filter Primary.....	A-56731	Fuel Filter Secondary.....	FC-55151
317B (EXCAVATORS) CAT S/N: 9MM1-UP		318C (EXCAVATORS) CAT 3066 (S/N: AWS1-UP) , 2004-UP		Fuel Filter Secondary.....	FC-55151
Air Filter Secondary.....	A-2705	Air Filter Primary.....	A-2706	Fuel Filter.....	FC-5516
Air Filter Primary.....	A-2706	Air Filter Secondary.....	A-2705	Hydraulic Oil Filter.....	HC-5801
Cabin Air Filter.....	CA-55850	Cabin Air Filter.....	CA-55850	Hydraulic Oil Filter.....	HC-5801
Fuel Filter.....	FC-1010	Fuel Filter Secondary.....	FC-5515	Oil Filter Full Flow.....	C-5504
Hydraulic Oil Filter.....	H-7942	Fuel Filter Secondary.....	FC-55151	317B (EXCAVATORS) CAT 3046	
Hydraulic Oil Filter.....	HC-5801	Fuel Filter.....	FC-5516	Hydraulic Oil Filter.....	HC-9901
Oil Filter Full Flow.....	C-5504	Hydraulic Oil Filter.....	HC-5801	317N (EXCAVATORS) CAT 3046 (S/N: 4MM1-UP)	
317B (EXCAVATORS) CAT 3046		Hydraulic Oil Filter.....	H-7942	Air Filter Secondary.....	A-5540
Hydraulic Oil Filter.....	HC-9901	Oil Filter Full Flow.....	C-5510	Oil Filter Full Flow.....	C-5102
317N (EXCAVATORS) CAT 3046 (S/N: 9SR1-UP)		317N (EXCAVATORS) CAT 3046 (S/N: 9SR1-UP)		317N (EXCAVATORS) CAT 3054T	
Air Filter Secondary.....	A-5540	Air Filter Secondary.....	A-5540	Hydraulic Oil Filter.....	HC-9901
Oil Filter Full Flow.....	C-5102	Oil Filter Full Flow.....	C-5102	317B L (EXCAVATORS) CAT 3046 (S/N: 6DZ1-UP)	
317N (EXCAVATORS) CAT 3054T		317N (EXCAVATORS) CAT 3046 T		Air Filter Secondary.....	A-2705
Hydraulic Oil Filter.....	HC-9901	Hydraulic Oil Filter.....	HC-9901	Air Filter Primary.....	A-2706
317B L (EXCAVATORS) CAT 3046 (S/N: 4MM1-UP)		317B L (EXCAVATORS) CAT 3046 T		Fuel Filter.....	FC-1010
Air Filter Secondary.....	A-2705	Hydraulic Oil Filter.....	HC-5801	Hydraulic Oil Filter.....	H-7942
Air Filter Primary.....	A-2706	Oil Filter Full Flow.....	C-5504	Oil Filter Full Flow.....	C-5504
Fuel Filter.....	FC-1010	317B L (EXCAVATORS) CAT 3046 (S/N: 9MM1-UP)		317B L (EXCAVATORS) CAT 3046 T	
Hydraulic Oil Filter.....	HC-5801	Air Filter Primary.....	A-2706	Hydraulic Oil Filter.....	HC-9901
Hydraulic Oil Filter.....	H-7942	Air Filter Secondary.....	A-2705	318 (EXCAVATORS) CAT 3116DIT	
Oil Filter Full Flow.....	C-5504	Fuel Filter.....	FC-1010	Air Filter.....	A-5596
317B L (EXCAVATORS) CAT 3046 (S/N: 6DZ1-UP)		Hydraulic Oil Filter.....	HC-5801	Air Filter Secondary.....	A-7913
Air Filter Secondary.....	A-2705	Hydraulic Oil Filter.....	H-7942	Air Filter Primary.....	AS-5523
Air Filter Primary.....	A-2706	Hydraulic Oil Filter.....	HC-5801	Coolant Filter.....	WC-5707
Fuel Filter.....	FC-1010	Oil Filter Full Flow.....	C-5504	Fuel Filter.....	FC-5516
Hydraulic Oil Filter.....	H-7942	318C (EXCAVATORS) CAT 3066 (S/N: DAH1-UP)		Fuel Filter Secondary.....	FC-55151
Hydraulic Oil Filter.....	HC-5801	Air Filter Set.....	A-5675-S	Fuel Filter Secondary.....	FC-55151
Oil Filter Full Flow.....	C-5504	Air Filter Secondary.....	A-8670	Fuel Filter.....	FC-5516
317B L (EXCAVATORS) CAT 3046 T		Air Filter Primary.....	A-5673	Hydraulic Oil Filter.....	HC-5801
Hydraulic Oil Filter.....	HC-9901	Cabin Air Filter.....	CA-55850	Hydraulic Oil Filter.....	HC-5801
318 (EXCAVATORS) CAT 3116DIT		Fuel Filter Secondary.....	FC-5515	Oil Filter Full Flow.....	C-5504
Air Filter.....	A-5596	Fuel Filter Secondary.....	FC-55151	318B (EXCAVATORS) S/N: 7KZ1-UP	
Air Filter Secondary.....	A-7913	Fuel Filter.....	FC-5516	Air Filter Primary.....	A-2706
Air Filter Primary.....	AS-5523	Hydraulic Oil Filter.....	HC-5801	Air Filter Secondary.....	A-2705
Coolant Filter.....	WC-5707	Hydraulic Oil Filter.....	H-7942	Cabin Air Filter.....	CA-55850
Fuel Filter.....	FC-5516	Oil Filter Full Flow.....	C-5510	Hydraulic Oil Filter.....	HC-5801
Fuel Filter Secondary.....	FC-55151	318C (EXCAVATORS) CAT 3066 (S/N: GPA1-UP)		Hydraulic Oil Filter.....	H-7942
		Air Filter Secondary.....	A-2705	Hydraulic Oil Filter.....	HC-5801
				Oil Filter Full Flow.....	C-5504

MODEL/APPLICATION	SAKURA NO	MODEL/APPLICATION	SAKURA NO	MODEL/APPLICATION	SAKURA NO
CATERPILLAR		CATERPILLAR		CATERPILLAR	
318B (EXCAVATORS) S/N: AEJ1-UP Air Filter Primary..... A-2706 Air Filter Secondary..... A-2705 Cabin Air Filter..... CA-55850 Hydraulic Oil Filter..... HC-5801 Hydraulic Oil Filter..... H-7942 Oil Filter Full Flow..... C-5504		Air Filter Primary..... A-8508 Air Filter Primary..... A-8508M Cabin Air Filter..... CA-55850 Fuel Filter..... FC-5516 Fuel Filter Secondary..... FC-55151 Fuel Filter Secondary..... FC-5515 Fuel Filter..... FC-1010 Hydraulic Oil Filter..... H-5522 Hydraulic Oil Filter..... HC-5801 Hydraulic Oil Filter..... HC-55170 Oil Filter Full Flow..... C-5510 Oil Filter Full Flow..... C-5522		Hydraulic Oil Filter..... H-5505 Oil Filter Full Flow..... C-5510 320 (EXCAVATORS) CAT 3066 (S/N: 7WK1-UP) Air Filter Set..... A-6118-S Air Filter Secondary..... A-6007 Air Filter Primary..... A-6006 Cabin Air Filter..... CA-55850 Fuel Filter..... F-5505 Hydraulic Oil Filter..... H-5505 Oil Filter Full Flow..... C-5510	
318C LN (EXCAVATORS) CAT 3066 , 2012 Air Filter Primary..... A-56731 Air Filter Set..... A-56731-S Air Filter Secondary..... A-56741		319C (EXCAVATORS) CAT S/N: KGL1-UP Air Filter Primary..... A-8508M Air Filter Primary..... A-8508 Air Filter Set..... A-8508M-S Air Filter Set..... A-8604-S Air Filter Secondary..... A-8578 Air Filter Primary..... AS-8577 Air Filter Secondary..... A-8670 Air Filter Secondary..... A-8507 Air Filter Primary..... A-5673 Air Filter Set..... A-5675-S Cabin Air Filter..... CA-55850 Fuel Filter Secondary..... FC-55151 Fuel Filter..... FC-5516 Fuel Filter..... FC-1010 Fuel Filter Secondary..... FC-5515 Hydraulic Oil Filter..... HC-55170 Hydraulic Oil Filter..... HC-5801 Hydraulic Oil Filter..... H-5522 Oil Filter Full Flow..... C-5522 Oil Filter Full Flow..... C-5510		320 (EXCAVATORS) CAT 3066 (S/N: 8LK1-UP) Air Filter Primary..... A-6006 Air Filter Secondary..... A-6007 Air Filter Set..... A-6118-S Cabin Air Filter..... CA-55850 Fuel Filter..... F-5505 Fuel Filter..... FC-1010 Hydraulic Oil Filter..... H-5505 Oil Filter Combination..... C-7916	
318C LN (EXCAVATORS) CAT 3046 (S/N: FAA1-UP) Air Filter Secondary..... A-8670 Air Filter Set..... A-5675-S Air Filter Primary..... A-5673 Fuel Filter Secondary..... FC-5515 Fuel Filter Secondary..... FC-55151 Fuel Filter..... FC-5516 Hydraulic Oil Filter..... H-7942 Hydraulic Oil Filter..... HC-5801 Oil Filter Full Flow..... C-5510		319C (EXCAVATORS) CAT S/N: 7JK1-UP Air Filter Primary..... A-56731 Air Filter Secondary..... A-56741 Air Filter Set..... A-56731-S		320 (EXCAVATORS) CAT 3116 (S/N: 1KL1-UP) Air Filter Set..... A-6118-S Air Filter Secondary..... A-6007 Air Filter Primary..... A-6006 Hydraulic Oil Filter..... HC-5801 Hydraulic Oil Filter..... H-5505 Hydraulic Oil Filter..... HC-5505 Oil Filter Combination..... C-7916 Oil Filter Full Flow..... C-5510	
318C BTG1 (EXCAVATORS) CAT 3066 Air Filter Secondary..... A-56741 Air Filter Set..... A-56731-S Air Filter Primary..... A-56731		319C (EXCAVATORS) CAT 7JK1-UP Air Filter Primary..... A-56731 Air Filter Secondary..... A-56741 Air Filter Set..... A-56731-S		320 (EXCAVATORS) CAT 3116 (S/N: 1XM1-UP) Air Filter Primary..... A-6006 Air Filter Secondary..... A-6007 Air Filter Set..... A-6118-S Fuel Filter..... FC-1010 Hydraulic Oil Filter..... HC-5505 Hydraulic Oil Filter..... H-5505 Oil Filter Full Flow..... C-5510 Oil Filter Combination..... C-7916	
318C DAH1 (EXCAVATORS) CAT 3066 Air Filter Primary..... A-56731 Air Filter Set..... A-56731-S Air Filter Secondary..... A-56741		319D (EXCAVATORS) CAT C4.2 , 4200, 2011 Air Filter Primary..... A-56731 Air Filter Set..... A-56731-S Air Filter Secondary..... A-56741		320 (EXCAVATORS) CAT 3116 (S/N: 2DL1-UP) Air Filter Set..... A-6118-S Air Filter Secondary..... A-6007 Air Filter Primary..... A-6006 Fuel Filter..... FC-1010 Hydraulic Oil Filter..... H-5505 Hydraulic Oil Filter..... HC-5505 Oil Filter Full Flow..... C-5510 Oil Filter Combination..... C-7916	
318C L DAH1 (EXCAVATORS) CAT 3046 Air Filter Secondary..... A-56741 Air Filter Set..... A-56731-S Air Filter Primary..... A-56731		319D (EXCAVATORS) CAT C4.2 ACERT Hydraulic Oil Filter..... HC-9901		320 (EXCAVATORS) CAT 3116 (S/N: 2DL-UP) Air Filter Primary..... A-6006 Air Filter Secondary..... A-6007 Air Filter Set..... A-6118-S Fuel Filter..... F-5505 Fuel Filter Secondary..... FC-5515	
318C LN FAA1 (EXCAVATORS) CAT 3046 Air Filter Primary..... A-56731 Air Filter Set..... A-56731-S Air Filter Secondary..... A-56741		319C LN (EXCAVATORS) CAT 3066 , 2012 Air Filter Secondary..... A-56741 Air Filter Set..... A-56731-S Air Filter Primary..... A-56731		320 (EXCAVATORS) CAT 3116 (S/N: 3RK1-UP) Air Filter Primary..... A-6006 Air Filter Secondary..... A-6007 Air Filter Set..... A-6118-S Cabin Air Filter..... CA-55850 Fuel Filter..... F-5505	
319C (EXCAVATORS) CAT 3066T Hydraulic Oil Filter..... HC-9901		319C LN (EXCAVATORS) CAT S/N: 7JK1-UP Air Filter Set..... A-5675-S Air Filter Primary..... A-5673 Air Filter Secondary..... A-8507 Air Filter Secondary..... A-8670 Air Filter Primary..... AS-8577 Air Filter Secondary..... A-8578 Air Filter Set..... A-8604-S Air Filter Set..... A-8508M-S		320 (EXCAVATORS) CAT 3116 (S/N: 2DL-UP) Air Filter Primary..... A-6006 Air Filter Secondary..... A-6007 Air Filter Set..... A-6118-S Fuel Filter..... F-5505 Fuel Filter Secondary..... FC-5515	

MODEL/APPLICATION	SAKURA NO	MODEL/APPLICATION	SAKURA NO	MODEL/APPLICATION	SAKURA NO
CATERPILLAR		CATERPILLAR		CATERPILLAR	
320 (EXCAVATORS) CAT 3116 (S/N: 2DL-UP) Fuel Filter Secondary..... FC-55151 Fuel Filter..... FC-5516 Hydraulic Oil Filter..... HC-5505 Hydraulic Oil Filter..... H-5505 Oil Filter Full Flow..... C-5510		320 (EXCAVATORS) CAT 3116 (S/N: 4ZJ-UP) Air Filter Set..... A-6118-S Air Filter Secondary..... A-6007 Air Filter Primary..... A-6006 Fuel Filter..... FC-5516 Fuel Filter Secondary..... FC-55151 Fuel Filter Secondary..... FC-5515 Fuel Filter..... F-5505 Hydraulic Oil Filter..... H-5505 Hydraulic Oil Filter..... HC-5505 Oil Filter Full Flow..... C-5510		320 (EXCAVATORS) CAT 3116 (S/N: 8LK-UP) Air Filter Primary..... A-6006 Air Filter Secondary..... A-6007 Air Filter Set..... A-6118-S Fuel Filter..... F-5505 Fuel Filter..... FC-5516 Fuel Filter Secondary..... FC-55151 Fuel Filter Secondary..... FC-5515 Fuel Filter Secondary..... FC-5515 Hydraulic Oil Filter..... HC-5505 Hydraulic Oil Filter..... H-5505 Oil Filter Full Flow..... C-5510	
320 (EXCAVATORS) CAT 3116 (S/N: 3RK-UP) Air Filter Set..... A-6118-S Air Filter Secondary..... A-6007 Air Filter Primary..... A-6006 Fuel Filter..... FC-5516 Fuel Filter Secondary..... FC-55151 Fuel Filter Secondary..... FC-5515 Fuel Filter..... F-5505 Hydraulic Oil Filter..... H-5505 Hydraulic Oil Filter..... HC-5505 Oil Filter Full Flow..... C-5510		320 (EXCAVATORS) CAT 3116 (S/N: 6KM1-UP) Air Filter Primary..... A-6006 Air Filter Secondary..... A-6007 Air Filter Set..... A-6118-S Fuel Filter..... F-5505 Fuel Filter Secondary..... FC-5515 Fuel Filter..... FC-5508 Fuel Filter Secondary..... FC-55151 Fuel Filter..... FC-5516 Hydraulic Oil Filter..... HC-5505 Hydraulic Oil Filter..... H-5505 Oil Filter Full Flow..... C-5510		320 (EXCAVATORS) CAT 3116 (S/N: 9KK1-UP) Air Filter Set..... A-6118-S Air Filter Secondary..... A-6007 Air Filter Primary..... A-6006 Fuel Filter..... FC-1010 Hydraulic Oil Filter..... H-5505 Hydraulic Oil Filter..... HC-5505 Oil Filter Combination..... C-7916 Oil Filter Full Flow..... C-5510	
320 (EXCAVATORS) CAT 3116 (S/N: 3XK822-UP) Air Filter Primary..... A-6006 Air Filter Secondary..... A-6007 Air Filter Set..... A-6118-S Fuel Filter..... F-5505 Fuel Filter Secondary..... FC-5515 Fuel Filter..... FC-5508 Fuel Filter Secondary..... FC-55151 Fuel Filter..... FC-5516 Hydraulic Oil Filter..... HC-5505 Hydraulic Oil Filter..... H-5505 Oil Filter Full Flow..... C-5510		320 (EXCAVATORS) CAT 3116 (S/N: 7WK-UP) Air Filter Set..... A-6118-S Air Filter Secondary..... A-6007 Air Filter Primary..... A-6006 Fuel Filter..... FC-5516 Fuel Filter Secondary..... FC-55151 Fuel Filter Secondary..... FC-5515 Fuel Filter..... F-5505 Hydraulic Oil Filter..... H-5505 Hydraulic Oil Filter..... HC-5505 Oil Filter Full Flow..... C-5510		320 (EXCAVATORS) CAT 3116 (S/N: 9WG723-UP) Air Filter Primary..... A-6006 Air Filter Secondary..... A-6007 Air Filter Set..... A-6118-S Fuel Filter..... F-5505 Fuel Filter..... FC-5508 Fuel Filter Secondary..... FC-5515 Fuel Filter Secondary..... FC-55151 Fuel Filter..... FC-5516 Hydraulic Oil Filter..... HC-5505 Hydraulic Oil Filter..... H-5505 Oil Filter Full Flow..... C-5510	
320 (EXCAVATORS) CAT 3116 (S/N: 3XM-UP) Air Filter Set..... A-6118-S Air Filter Secondary..... A-6007 Air Filter Primary..... A-6006 Fuel Filter..... FC-5516 Fuel Filter Secondary..... FC-55151 Fuel Filter Secondary..... FC-5515 Fuel Filter..... F-5505 Hydraulic Oil Filter..... H-5505 Hydraulic Oil Filter..... HC-5505 Oil Filter Full Flow..... C-5510		320 (EXCAVATORS) CAT 3116 (S/N: 8HL-UP) Air Filter Primary..... A-6006 Air Filter Secondary..... A-6007 Air Filter Set..... A-6118-S Fuel Filter..... F-5505 Fuel Filter Secondary..... FC-5515 Fuel Filter Secondary..... FC-55151 Fuel Filter..... FC-5516 Hydraulic Oil Filter..... HC-5505 Hydraulic Oil Filter..... H-5505 Oil Filter Full Flow..... C-5510		320 (EXCAVATORS) CAT 3066 Air Filter Secondary..... A-6007 Oil Filter Full Flow..... C-7105	
320 (EXCAVATORS) CAT 3116 (S/N: 4ZJ460-UP) Air Filter Primary..... A-6006 Air Filter Secondary..... A-6007 Air Filter Set..... A-6118-S Fuel Filter..... F-5505 Fuel Filter Secondary..... FC-5515 Fuel Filter..... FC-5508 Fuel Filter Secondary..... FC-55151 Fuel Filter..... FC-5516 Hydraulic Oil Filter..... HC-5505 Hydraulic Oil Filter..... H-5505 Oil Filter Full Flow..... C-5510		320 (EXCAVATORS) CAT 3116 (S/N: 8LK1-UP) Air Filter Set..... A-6118-S Air Filter Secondary..... A-6007 Air Filter Primary..... A-6006 Hydraulic Oil Filter..... H-5505 Hydraulic Oil Filter..... HC-5505 Hydraulic Oil Filter..... HC-5801 Oil Filter Combination..... C-7916 Oil Filter Full Flow..... C-5510		320B (EXCAVATORS) 7JK1-ON Oil Filter Full Flow..... C-5506	
				320B (EXCAVATORS) CAT 3116 (S/N: 1XS1-UP) Air Filter Primary..... A-5549M Air Filter Primary..... A-5549 Air Filter Secondary..... A-5550 Air Filter Set..... A-5549M-S Air Filter Secondary..... A-8507 Air Filter Primary..... A-8508M Air Filter Primary..... A-8508 Air Filter Set..... A-8508M-S Air Filter Set..... A-8604-S Fuel Filter..... FC-5516 Fuel Filter Secondary..... FC-55151 Fuel Filter Secondary..... FC-5515 Fuel Filter..... FC-5508 Hydraulic Oil Filter..... HC-5801	

MODEL/APPLICATION	SAKURA NO
CATERPILLAR	
320B (EXCAVATORS) CAT 3116 (S/N: 1XS1-UP)	
Hydraulic Oil Filter.....	HC-5505
Hydraulic Oil Filter.....	H-7942
Oil Filter Full Flow.....	C-5510
320B (EXCAVATORS) CAT 3116 (S/N: 2AS1-UP)	
Air Filter Set.....	A-8604-S
Air Filter Set.....	A-8508M-S
Air Filter Primary.....	A-8508
Air Filter Primary.....	A-8508M
Air Filter Secondary.....	A-8507
Air Filter Set.....	A-5549M-S
Air Filter Secondary.....	A-5550
Air Filter Primary.....	A-5549
Air Filter Primary.....	A-5549M
Fuel Filter.....	FC-5508
Fuel Filter Secondary.....	FC-5515
Fuel Filter Secondary.....	FC-55151
Fuel Filter.....	FC-5516
Hydraulic Oil Filter.....	H-7942
Hydraulic Oil Filter.....	HC-5505
Hydraulic Oil Filter.....	HC-5801
Oil Filter Full Flow.....	C-5510
320B (EXCAVATORS) CAT 3116 (S/N: 3YZ1-UP)	
Air Filter Secondary.....	A-8507
Air Filter Primary.....	A-8508M
Air Filter Primary.....	A-8508
Air Filter Set.....	A-8508M-S
Air Filter Set.....	A-8604-S
Fuel Filter.....	FC-5516
Fuel Filter Secondary.....	FC-55151
Fuel Filter Secondary.....	FC-5515
Fuel Filter.....	FC-5508
Hydraulic Oil Filter.....	HC-5801
Hydraulic Oil Filter.....	HC-5505
Hydraulic Oil Filter.....	H-7942
Oil Filter Full Flow.....	C-5510
320B (EXCAVATORS) CAT 3116 (S/N: 4XW1-UP)	
Air Filter Set.....	A-8604-S
Air Filter Set.....	A-8508M-S
Air Filter Primary.....	A-8508
Air Filter Primary.....	A-8508M
Air Filter Secondary.....	A-8507
Fuel Filter.....	FC-1010
Fuel Filter Secondary.....	FC-5515
Fuel Filter Secondary.....	FC-55151
Fuel Filter.....	FC-5516
Hydraulic Oil Filter.....	H-7942
Hydraulic Oil Filter.....	HC-5505
Hydraulic Oil Filter.....	HC-5801
Oil Filter Full Flow.....	C-5510
320B (EXCAVATORS) CAT 3116 (S/N: 5BR1-UP)	
Air Filter Secondary.....	A-8507
Air Filter Primary.....	A-8508M
Air Filter Primary.....	A-5549M

MODEL/APPLICATION	SAKURA NO
CATERPILLAR	
Air Filter Primary.....	A-5549
Air Filter Secondary.....	A-5550
Air Filter Set.....	A-5549M-S
Air Filter Primary.....	A-8508
Air Filter Set.....	A-8508M-S
Air Filter Set.....	A-8604-S
Fuel Filter.....	FC-1010
Hydraulic Oil Filter.....	HC-5801
Hydraulic Oil Filter.....	HC-5505
Hydraulic Oil Filter.....	H-7942
Oil Filter Full Flow.....	C-5510
320B (EXCAVATORS) CAT 3116 (S/N: 5GW1-UP)	
Air Filter Set.....	A-8604-S
Air Filter Set.....	A-8508M-S
Air Filter Primary.....	A-8508
Air Filter Primary.....	A-8508M
Air Filter Secondary.....	A-8507
Fuel Filter.....	FC-1010
Fuel Filter Secondary.....	FC-5515
Fuel Filter.....	FC-5516
Fuel Filter Secondary.....	FC-55151
Hydraulic Oil Filter.....	H-7942
Hydraulic Oil Filter.....	HC-5505
Hydraulic Oil Filter.....	HC-5801
Oil Filter Full Flow.....	C-5510
320B (EXCAVATORS) CAT 3116 (S/N: 5MS1-UP)	
Air Filter Secondary.....	A-8507
Air Filter Primary.....	A-8508M
Air Filter Primary.....	A-8508
Air Filter Set.....	A-8508M-S
Air Filter Set.....	A-8604-S
Fuel Filter Secondary.....	FC-55151
Fuel Filter.....	FC-5516
Fuel Filter Secondary.....	FC-5515
Fuel Filter.....	FC-5508
Hydraulic Oil Filter.....	HC-5801
Hydraulic Oil Filter.....	HC-5505
Hydraulic Oil Filter.....	H-7942
Oil Filter Full Flow.....	C-5510
320B (EXCAVATORS) CAT 3116 (S/N: 6CR1-UP)	
Air Filter Primary.....	A-8508M
Air Filter Secondary.....	A-8507
Air Filter Set.....	A-5549M-S
Air Filter Secondary.....	A-5550
Air Filter Primary.....	A-5549
Air Filter Primary.....	A-5549M
Air Filter Set.....	A-8604-S
Air Filter Set.....	A-8508M-S
Air Filter Primary.....	A-8508
Fuel Filter.....	FC-1010
Hydraulic Oil Filter.....	H-7942
Hydraulic Oil Filter.....	HC-5505
Hydraulic Oil Filter.....	HC-5801
Oil Filter Full Flow.....	C-5510
320B (EXCAVATORS) CAT 3116 (S/N: 6LW1-UP)	

MODEL/APPLICATION	SAKURA NO
CATERPILLAR	
Air Filter Secondary.....	A-8507
Air Filter Primary.....	A-8508M
Air Filter Primary.....	A-8508
Air Filter Set.....	A-8508M-S
Air Filter Set.....	A-8604-S
Fuel Filter.....	FC-5508
Fuel Filter Secondary.....	FC-5515
Fuel Filter.....	FC-5516
Fuel Filter Secondary.....	FC-55151
Hydraulic Oil Filter.....	HC-5801
Hydraulic Oil Filter.....	HC-5505
Hydraulic Oil Filter.....	H-7942
Oil Filter Full Flow.....	C-5510
320B (EXCAVATORS) CAT 3116 (S/N: 7JR1-UP)	
Air Filter Set.....	A-8604-S
Air Filter Set.....	A-8508M-S
Air Filter Primary.....	A-8508
Air Filter Primary.....	A-8508M
Air Filter Secondary.....	A-8507
Air Filter Primary.....	A-5549M
Air Filter Secondary.....	A-5550
Air Filter Set.....	A-5549M-S
Fuel Filter Secondary.....	FC-55151
Fuel Filter.....	FC-5516
Fuel Filter Secondary.....	FC-5515
Fuel Filter.....	FC-5508
Hydraulic Oil Filter.....	H-7942
Hydraulic Oil Filter.....	HC-5505
Hydraulic Oil Filter.....	HC-5801
Oil Filter Full Flow.....	C-5510
320B (EXCAVATORS) CAT 3116 (S/N: 9WS1-UP)	
Air Filter Set.....	A-5549M-S
Air Filter Secondary.....	A-5550
Air Filter Primary.....	A-5549
Air Filter Primary.....	A-5549M
Air Filter Secondary.....	A-8507
Air Filter Primary.....	A-8508M
Air Filter Primary.....	A-8508
Air Filter Set.....	A-8508M-S
Air Filter Set.....	A-8604-S
Fuel Filter.....	FC-5508
Fuel Filter Secondary.....	FC-5515
Fuel Filter.....	FC-5516
Fuel Filter Secondary.....	FC-55151
Hydraulic Oil Filter.....	HC-5801
Hydraulic Oil Filter.....	HC-5505
Hydraulic Oil Filter.....	H-7942
Oil Filter Full Flow.....	C-5510
320BL (EXCAVATORS) CAT 3066 (S/N: 5BR1-UP)	
Air Filter Set.....	A-8604-S
Air Filter Set.....	A-8508M-S
Air Filter Primary.....	A-8508
Air Filter Primary.....	A-8508M
Air Filter Secondary.....	A-8507
Fuel Filter.....	FC-1010

MODEL/APPLICATION	SAKURA NO
CATERPILLAR	
320BL (EXCAVATORS) CAT 3066 (S/N: 6CR1-UP)	
Air Filter Secondary.....	A-8507
Air Filter Primary.....	A-8508M
Air Filter Primary.....	A-8508
Air Filter Set.....	A-8508M-S
Air Filter Set.....	A-8604-S
Fuel Filter.....	FC-1010
320BL (EXCAVATORS) CAT 3116 S/N: 4TF67498-UP	
Air Filter Set.....	A-8604-S
Air Filter Set.....	A-8508M-S
Air Filter Secondary.....	A-8507
Air Filter Primary.....	A-8508
Air Filter Primary.....	A-8508M
Fuel Filter.....	FC-5508
Fuel Filter Secondary.....	FC-5515
Fuel Filter Secondary.....	FC-55151
Fuel Filter.....	FC-5516
Hydraulic Oil Filter.....	H-7942
Hydraulic Oil Filter.....	HC-5801
Hydraulic Oil Filter.....	HC-5505
Oil Filter Full Flow.....	C-5510
320BL (EXCAVATORS) CAT 3116 S/N: 7JR3036-UP	
Air Filter Primary.....	A-8508M
Air Filter Primary.....	A-8508
Air Filter Secondary.....	A-8507
Air Filter Set.....	A-8508M-S
Air Filter Set.....	A-8604-S
Fuel Filter.....	FC-5508
Fuel Filter.....	FC-5516
Fuel Filter Secondary.....	FC-55151
Fuel Filter Secondary.....	FC-5515
Hydraulic Oil Filter.....	HC-5505
Hydraulic Oil Filter.....	HC-5801
Hydraulic Oil Filter.....	H-7942
Oil Filter Full Flow.....	C-5510
320BL (EXCAVATORS) S/N: 7JR1954-UP	
Air Filter Set.....	A-8604-S
Air Filter Set.....	A-8508M-S
Air Filter Secondary.....	A-8507
Air Filter Primary.....	A-8508
Air Filter Primary.....	A-8508M
Cabin Air Filter.....	CA-55850
Fuel Filter.....	FC-5508
Fuel Filter Secondary.....	FC-5515
Fuel Filter Secondary.....	FC-55151
Fuel Filter.....	FC-5516
Hydraulic Oil Filter.....	H-7942
Hydraulic Oil Filter.....	HC-5505
Oil Filter Full Flow.....	C-5510
320BL (EXCAVATORS) S/N: 7JR1960-UP	
Air Filter Secondary.....	A-8507
Air Filter Set.....	A-8508M-S
Air Filter Set.....	A-8604-S
Air Filter Primary.....	A-8508M

MODEL/APPLICATION	SAKURA NO
CATERPILLAR	
Air Filter Primary.....	A-8508
Cabin Air Filter.....	CA-55850
Fuel Filter.....	FC-5508
Fuel Filter.....	FC-5516
Fuel Filter Secondary.....	FC-55151
Fuel Filter Secondary.....	FC-5515
Hydraulic Oil Filter.....	H-7942
Hydraulic Oil Filter.....	HC-5505
Oil Filter Full Flow.....	C-5510
320BL (EXCAVATORS) S/N: 7JR2461-UP	
Air Filter Set.....	A-8604-S
Air Filter Set.....	A-8508M-S
Air Filter Secondary.....	A-8507
Air Filter Primary.....	A-8508
Air Filter Primary.....	A-8508M
Cabin Air Filter.....	CA-55850
Fuel Filter.....	FC-5508
Fuel Filter Secondary.....	FC-5515
Fuel Filter Secondary.....	FC-55151
Fuel Filter.....	FC-5516
Hydraulic Oil Filter.....	H-7942
Hydraulic Oil Filter.....	HC-5505
Oil Filter Full Flow.....	C-5510
320C (EXCAVATORS) CAT 3066T	
Hydraulic Oil Filter.....	HC-9901
320C (EXCAVATORS) CAT 3066 (S/N: AKH1-UP)	
Air Filter Primary.....	A-5549M
Air Filter Primary.....	A-8508
Air Filter Set.....	A-8508M-S
Air Filter Set.....	A-8604-S
Air Filter Set.....	A-5549M-S
Air Filter Secondary.....	A-5550
Air Filter Primary.....	A-5549
Air Filter Secondary.....	A-8507
Air Filter Primary.....	A-8508M
Cabin Air Filter.....	CA-55850
Fuel Filter.....	FC-5516
Fuel Filter Secondary.....	FC-55151
Fuel Filter Secondary.....	FC-5515
Hydraulic Oil Filter.....	HC-5801
Hydraulic Oil Filter.....	H-5522
Hydraulic Oil Filter.....	H-7942
Oil Filter Full Flow.....	C-5510
320C (EXCAVATORS) CAT 3066 (S/N: ALF1-UP)	
Air Filter Set.....	A-8604-S
Air Filter Set.....	A-8508M-S
Air Filter Primary.....	A-8508
Air Filter Primary.....	A-8508M
Air Filter Secondary.....	A-8507
Air Filter Primary.....	A-5549
Air Filter Secondary.....	A-5550
Air Filter Set.....	A-5549M-S
Air Filter Primary.....	A-5549M
Cabin Air Filter.....	CA-55850
Fuel Filter Secondary.....	FC-5515

MODEL/APPLICATION	SAKURA NO
CATERPILLAR	
Fuel Filter Secondary.....	FC-55151
Fuel Filter.....	FC-5516
Hydraulic Oil Filter.....	H-7942
Hydraulic Oil Filter.....	H-5522
Hydraulic Oil Filter.....	HC-5801
Oil Filter Full Flow.....	C-5510
320C (EXCAVATORS) CAT 3066 (S/N: AMC1-UP)	
Air Filter Primary.....	A-5549M
Air Filter Primary.....	A-8508
Air Filter Set.....	A-8508M-S
Air Filter Set.....	A-8604-S
Air Filter Set.....	A-5549M-S
Air Filter Secondary.....	A-5550
Air Filter Primary.....	A-5549
Air Filter Secondary.....	A-8507
Air Filter Primary.....	A-8508M
Fuel Filter.....	FC-5516
Fuel Filter Secondary.....	FC-55151
Fuel Filter Secondary.....	FC-5515
Hydraulic Oil Filter.....	H-7942
Hydraulic Oil Filter.....	HC-5801
Oil Filter Full Flow.....	C-5510
320C (EXCAVATORS) CAT 3066 (S/N: ANB1-UP)	
Air Filter Set.....	A-8604-S
Air Filter Set.....	A-8508M-S
Air Filter Primary.....	A-8508
Air Filter Primary.....	A-5549M
Air Filter Primary.....	A-8508M
Air Filter Secondary.....	A-8507
Air Filter Primary.....	A-5549
Air Filter Secondary.....	A-5550
Air Filter Set.....	A-5549M-S
Fuel Filter Secondary.....	FC-5515
Fuel Filter Secondary.....	FC-55151
Fuel Filter.....	FC-5516
Hydraulic Oil Filter.....	HC-5801
Hydraulic Oil Filter.....	H-7942
Oil Filter Full Flow.....	C-5510
320C (EXCAVATORS) CAT 3066 (S/N: BBC1-UP)	
Air Filter Secondary.....	A-8507
Air Filter Primary.....	A-8508M
Air Filter Primary.....	A-8508
Air Filter Set.....	A-8508M-S
Air Filter Set.....	A-8604-S
Fuel Filter.....	FC-5516
Fuel Filter Secondary.....	FC-55151
Fuel Filter Secondary.....	FC-5515
Hydraulic Oil Filter.....	HC-5801
Hydraulic Oil Filter.....	H-7942
Oil Filter Full Flow.....	C-5510
320C (EXCAVATORS) CAT 3066 (S/N: BCN1-UP)	
Air Filter Set.....	A-8604-S
Air Filter Set.....	A-8508M-S
Air Filter Primary.....	A-8508
Air Filter Primary.....	A-8508M

Sakura Filter

ENGINE APPLICATION

MODEL/APPLICATION	SAKURA NO
CATERPILLAR	
320C (EXCAVATORS) CAT 3066 (S/N: EGA1-UP)	
Air Filter Set.....	A-5549M-S
Cabin Air Filter.....	CA-55850
Fuel Filter.....	FC-5516
Fuel Filter Secondary.....	FC-55151
Fuel Filter Secondary.....	FC-5515
Hydraulic Oil Filter.....	HC-5801
Hydraulic Oil Filter.....	H-5522
Oil Filter Full Flow.....	C-5510
320C (EXCAVATORS) CAT 3066 (S/N: EGL1-09999-UP)	
Air Filter Set.....	A-5549M-S
Air Filter Secondary.....	A-5550
Air Filter Primary.....	A-5549
Air Filter Primary.....	A-5549M
Cabin Air Filter.....	CA-55850
Fuel Filter Secondary.....	FC-5515
Fuel Filter Secondary.....	FC-55151
Fuel Filter.....	FC-5516
Hydraulic Oil Filter.....	H-5522
Hydraulic Oil Filter.....	HC-5801
Oil Filter Full Flow.....	C-5510
320C (EXCAVATORS) CAT 3066 (S/N: GLA1-UP)	
Air Filter Primary.....	A-5549M
Air Filter Primary.....	A-5549
Air Filter Secondary.....	A-5550
Air Filter Set.....	A-5549M-S
Cabin Air Filter.....	CA-55850
Fuel Filter.....	FC-5516
Fuel Filter Secondary.....	FC-55151
Fuel Filter Secondary.....	FC-5515
Hydraulic Oil Filter.....	HC-5801
Hydraulic Oil Filter.....	H-5522
Oil Filter Full Flow.....	C-5510
320C (EXCAVATORS) CAT 3066 (S/N: JTG1-UP)	
Air Filter Primary.....	A-5549M
Air Filter Set.....	A-5549M-S
Air Filter Secondary.....	A-5550
Air Filter Primary.....	A-5549
Cabin Air Filter.....	CA-55850
Fuel Filter Secondary.....	FC-5515
Fuel Filter Secondary.....	FC-55151
Fuel Filter.....	FC-5516
Hydraulic Oil Filter.....	H-5522
Hydraulic Oil Filter.....	HC-5801
Oil Filter Full Flow.....	C-5510
320C (EXCAVATORS) CAT 3066 (S/N: MAB1-UP)	
Air Filter Primary.....	A-8508M
Air Filter Secondary.....	A-8507
Air Filter Set.....	A-8604-S
Air Filter Set.....	A-8508M-S
Air Filter Primary.....	A-8508
Cabin Air Filter.....	CA-55850
Fuel Filter.....	FC-5516
Fuel Filter Secondary.....	FC-55151

MODEL/APPLICATION	SAKURA NO
CATERPILLAR	
Fuel Filter Secondary.....	FC-5515
Hydraulic Oil Filter.....	HC-5801
Hydraulic Oil Filter.....	H-7942
Oil Filter Full Flow.....	C-5510
320C (EXCAVATORS) CAT 3066 (S/N: MAC1-UP)	
Air Filter Secondary.....	A-8507
Air Filter Primary.....	A-8508M
Air Filter Primary.....	A-8508
Air Filter Set.....	A-8508M-S
Air Filter Set.....	A-8604-S
Cabin Air Filter.....	CA-55850
Fuel Filter Secondary.....	FC-5515
Fuel Filter Secondary.....	FC-55151
Fuel Filter.....	FC-5516
Hydraulic Oil Filter.....	H-7942
Hydraulic Oil Filter.....	HC-5801
Oil Filter Full Flow.....	C-5510
320C (EXCAVATORS) CAT 3066 (S/N: PAB1-UP)	
Air Filter Primary.....	A-8508M
Air Filter Secondary.....	A-8507
Air Filter Set.....	A-8604-S
Air Filter Set.....	A-8508M-S
Air Filter Primary.....	A-8508
Cabin Air Filter.....	CA-55850
Fuel Filter.....	FC-5516
Fuel Filter Secondary.....	FC-55151
Fuel Filter Secondary.....	FC-5515
Hydraulic Oil Filter.....	HC-5801
Hydraulic Oil Filter.....	H-7942
Oil Filter Full Flow.....	C-5510
320C (EXCAVATORS) CAT 3066 (S/N: PAC1-UP)	
Air Filter Primary.....	A-8508
Air Filter Set.....	A-8508M-S
Air Filter Set.....	A-8604-S
Air Filter Secondary.....	A-8507
Air Filter Primary.....	A-8508M
Cabin Air Filter.....	CA-55850
Fuel Filter Secondary.....	FC-5515
Fuel Filter Secondary.....	FC-55151
Fuel Filter.....	FC-5516
Hydraulic Oil Filter.....	H-7942
Hydraulic Oil Filter.....	HC-5801
Oil Filter Full Flow.....	C-5510
320C (EXCAVATORS) CAT 3066 (S/N: RAW1-UP)	
Air Filter Primary.....	A-8508M
Air Filter Secondary.....	A-8507
Air Filter Set.....	A-8604-S
Air Filter Set.....	A-8508M-S
Air Filter Primary.....	A-8508
Cabin Air Filter.....	CA-55850
Fuel Filter.....	FC-5516
Fuel Filter Secondary.....	FC-55151
Fuel Filter Secondary.....	FC-5515
Hydraulic Oil Filter.....	HC-5801
Hydraulic Oil Filter.....	H-7942

MODEL/APPLICATION	SAKURA NO
CATERPILLAR	
Oil Filter Full Flow.....	C-5510
320C (EXCAVATORS) CAT 3066 (S/N: SBN1-UP)	
Air Filter Primary.....	A-8508
Air Filter Set.....	A-8508M-S
Air Filter Set.....	A-8604-S
Air Filter Secondary.....	A-8507
Air Filter Primary.....	A-8508M
Cabin Air Filter.....	CA-55850
Fuel Filter Secondary.....	FC-5515
Fuel Filter Secondary.....	FC-55151
Fuel Filter.....	FC-5516
Hydraulic Oil Filter.....	H-7942
Hydraulic Oil Filter.....	HC-5801
Oil Filter Full Flow.....	C-5510
320C L (EXCAVATORS) CAT 3066 (S/N: AMC1-UP)	
Air Filter Set.....	A-5549M-S
Air Filter Set.....	A-8508M-S
Air Filter Primary.....	A-8508
Air Filter Primary.....	A-8508M
Air Filter Secondary.....	A-8507
Air Filter Primary.....	A-5549M
Air Filter Primary.....	A-5549
Air Filter Secondary.....	A-5550
Air Filter Set.....	A-8604-S
Fuel Filter Secondary.....	FC-5515
Fuel Filter Secondary.....	FC-55151
Fuel Filter.....	FC-5516
Hydraulic Oil Filter.....	HC-5801
Hydraulic Oil Filter.....	H-7942
Oil Filter Full Flow.....	C-5510
320C L (EXCAVATORS) CAT 3066 (S/N: ANB1-UP)	
Air Filter Set.....	A-5549M-S
Air Filter Secondary.....	A-8507
Air Filter Primary.....	A-8508M
Air Filter Primary.....	A-8508
Air Filter Set.....	A-8508M-S
Air Filter Set.....	A-8604-S
Air Filter Secondary.....	A-5550
Air Filter Primary.....	A-5549
Air Filter Primary.....	A-5549M
Fuel Filter.....	FC-5516
Fuel Filter Secondary.....	FC-55151
Fuel Filter Secondary.....	FC-5515
Hydraulic Oil Filter.....	H-7942
Hydraulic Oil Filter.....	HC-5801
Oil Filter Full Flow.....	C-5510
320C L (EXCAVATORS) CAT 3066 (S/N: BBC1-UP)	
Air Filter Set.....	A-8508M-S
Air Filter Primary.....	A-8508
Air Filter Primary.....	A-8508M
Air Filter Secondary.....	A-8507
Air Filter Set.....	A-8604-S
Fuel Filter Secondary.....	FC-5515
Fuel Filter Secondary.....	FC-55151
Fuel Filter.....	FC-5516

MODEL/APPLICATION	SAKURA NO	MODEL/APPLICATION	SAKURA NO	MODEL/APPLICATION	SAKURA NO
CATERPILLAR		CATERPILLAR		CATERPILLAR	
320C LU (EXCAVATORS) CAT 3066 (S/N: CLZ1-UP)		Hydraulic Oil Filter..... H-7942		Air Filter Secondary..... A-8507	
Hydraulic Oil Filter..... H-7942		Hydraulic Oil Filter..... HC-5505		Air Filter Primary..... A-8508M	
Hydraulic Oil Filter..... HC-5801		Oil Filter Full Flow..... C-5510		Fuel Filter..... FC-5516	
Oil Filter Full Flow..... C-5510		320B LN (EXCAVATORS) CAT 3066 (S/N: 1XS1-UP)		Fuel Filter Secondary..... FC-55151	
320C LU (EXCAVATORS) CAT 3066 ATAAC		Air Filter Set..... A-5549M-S		Fuel Filter Secondary..... FC-5515	
Hydraulic Oil Filter..... HC-9901		Air Filter Secondary..... A-5550		Fuel Filter..... FC-5508	
320C U (EXCAVATORS) CAT 3066 (S/N: CLM1-UP)		Air Filter Primary..... A-5549		Hydraulic Oil Filter..... HC-5801	
Air Filter Secondary..... A-8507		Air Filter Primary..... A-5549M		Hydraulic Oil Filter..... H-7942	
Air Filter Primary..... A-8508M		Air Filter Primary..... A-8508M		Hydraulic Oil Filter..... HC-5505	
Air Filter Primary..... A-8508		Air Filter Primary..... A-8508		Oil Filter Full Flow..... C-5510	
Air Filter Set..... A-8508M-S		Air Filter Set..... A-8508M-S		320B LN (EXCAVATORS) CAT 3066 (S/N: 6LW1-UP)	
Air Filter Set..... A-8604-S		Air Filter Set..... A-8604-S		Air Filter Primary..... A-8508M	
Fuel Filter..... FC-5516		Fuel Filter..... FC-5508		Air Filter Secondary..... A-8507	
Fuel Filter Secondary..... FC-55151		Fuel Filter Secondary..... FC-5515		Air Filter Primary..... A-8508	
Fuel Filter Secondary..... FC-5515		Fuel Filter Secondary..... FC-55151		Air Filter Set..... A-8508M-S	
Hydraulic Oil Filter..... HC-5801		Fuel Filter..... FC-5516		Air Filter Set..... A-8604-S	
Hydraulic Oil Filter..... H-7942		Hydraulic Oil Filter..... HC-5505		Fuel Filter..... FC-5508	
Oil Filter Full Flow..... C-5510		Hydraulic Oil Filter..... H-7942		Fuel Filter Secondary..... FC-5515	
320C U (EXCAVATORS) CAT 3066 (S/N: CLZ1-UP)		Hydraulic Oil Filter..... HC-5801		Fuel Filter Secondary..... FC-55151	
Air Filter Set..... A-8604-S		Oil Filter Full Flow..... C-5510		Fuel Filter..... FC-5516	
Air Filter Set..... A-8508M-S		320B LN (EXCAVATORS) CAT 3066 (S/N: 2AS1-UP)		Hydraulic Oil Filter..... HC-5505	
Air Filter Primary..... A-8508		Air Filter Set..... A-8604-S		Hydraulic Oil Filter..... H-7942	
Air Filter Primary..... A-8508M		Air Filter Set..... A-8508M-S		Hydraulic Oil Filter..... HC-5801	
Air Filter Primary..... A-8508M		Air Filter Primary..... A-8508		Oil Filter Full Flow..... C-5510	
Air Filter Secondary..... A-8507		Air Filter Primary..... A-8508M		320B LN (EXCAVATORS) CAT 3066 (S/N: 7JR1-UP)	
Fuel Filter Secondary..... FC-5515		Air Filter Primary..... A-5549M		Air Filter Set..... A-8604-S	
Fuel Filter Secondary..... FC-55151		Air Filter Primary..... A-5549		Air Filter Set..... A-8508M-S	
Fuel Filter..... FC-5516		Air Filter Secondary..... A-5550		Air Filter Primary..... A-8508	
Hydraulic Oil Filter..... H-7942		Air Filter Primary..... A-5549M		Air Filter Primary..... A-8508M	
Hydraulic Oil Filter..... HC-5801		Fuel Filter..... FC-5516		Air Filter Set..... A-5549M-S	
Oil Filter Full Flow..... C-5510		Fuel Filter Secondary..... FC-55151		Air Filter Secondary..... A-5550	
320C U (EXCAVATORS) CAT 3066 ATAAC		Fuel Filter Secondary..... FC-5515		Air Filter Primary..... A-5549	
Hydraulic Oil Filter..... HC-9901		Fuel Filter..... FC-5508		Air Filter Primary..... A-5549M	
320D (EXCAVATORS) 2006-UP		Hydraulic Oil Filter..... HC-5801		Fuel Filter..... FC-5516	
Air Filter Set..... A-8604-S		Hydraulic Oil Filter..... H-7942		Fuel Filter Secondary..... FC-55151	
Air Filter Set..... A-8508M-S		Hydraulic Oil Filter..... HC-5505		Fuel Filter..... FC-5515	
Air Filter Primary..... A-8508		Oil Filter Full Flow..... C-5510		Fuel Filter..... FC-5508	
Air Filter Primary..... A-8508M		320B LN (EXCAVATORS) CAT 3066 (S/N: 3YZ1-UP)		Hydraulic Oil Filter..... HC-5801	
Air Filter Secondary..... A-8507		Air Filter Primary..... A-8508M		Hydraulic Oil Filter..... H-7942	
Fuel Filter Secondary..... FC-5515		Air Filter Secondary..... A-8507		Hydraulic Oil Filter..... HC-5505	
Fuel Filter Secondary..... FC-55151		Air Filter Primary..... A-8508		Oil Filter Full Flow..... C-5510	
Fuel Filter..... FC-5516		Air Filter Primary..... A-8508M		320B LN (EXCAVATORS) CAT 3066 (S/N: 9WS1-UP)	
Oil Filter Full Flow..... C-5510		Air Filter Set..... A-8508M-S		Air Filter Primary..... A-5549M	
320D (EXCAVATORS) CAT C6.4 ACERT		Air Filter Set..... A-8604-S		Air Filter Primary..... A-5549	
Hydraulic Oil Filter..... HC-9901		Fuel Filter..... FC-5508		Air Filter Secondary..... A-5550	
320 BLM (EXCAVATORS)		Fuel Filter Secondary..... FC-5515		Air Filter Set..... A-5549M-S	
Fuel Filter..... FC-5516		Fuel Filter..... FC-55151		Air Filter Primary..... A-8508M	
Fuel Filter Secondary..... FC-55151		Fuel Filter..... FC-5516		Air Filter Primary..... A-8508	
Fuel Filter Secondary..... FC-5515		Hydraulic Oil Filter..... HC-5505		Air Filter Set..... A-8508M-S	
Fuel Filter..... FC-5508		Hydraulic Oil Filter..... H-7942		Air Filter Set..... A-8604-S	
Hydraulic Oil Filter..... HC-5801		Hydraulic Oil Filter..... HC-5801		Fuel Filter..... FC-5508	
320B LN (EXCAVATORS) CAT 3066 (S/N: 5MS1-UP)		Oil Filter Full Flow..... C-5510		Fuel Filter Secondary..... FC-5515	
Air Filter Set..... A-8604-S		320B LN (EXCAVATORS) CAT 3066 (S/N: 5MS1-UP)		Fuel Filter Secondary..... FC-55151	
Air Filter Set..... A-8508M-S		Air Filter Set..... A-8604-S		Fuel Filter..... FC-5516	
Air Filter Primary..... A-8508		Fuel Filter..... FC-5508		Hydraulic Oil Filter..... HC-5505	
320B LN (EXCAVATORS) CAT 3066 (S/N: 5MS1-UP)		Fuel Filter Secondary..... FC-5515		Hydraulic Oil Filter..... H-7942	
Air Filter Set..... A-8604-S		Fuel Filter Secondary..... FC-55151		Hydraulic Oil Filter..... HC-5801	
Air Filter Set..... A-8508M-S		Fuel Filter..... FC-5516			
Air Filter Primary..... A-8508		Hydraulic Oil Filter..... HC-5505			
		Hydraulic Oil Filter..... H-7942			
		Hydraulic Oil Filter..... HC-5801			

MODEL/APPLICATION	SAKURA NO
CATERPILLAR	
320B U (EXCAVATORS) CAT 3066 (S/N: BBG1-UP)	
Hydraulic Oil Filter.....	HC-5505
Hydraulic Oil Filter.....	H-5505
Oil Filter Full Flow.....	C-5510
320C FM (DELIMBERS) CAT 3066 (S/N: SAH1-UP)	
Air Filter Set.....	A-8604-S
Air Filter Set.....	A-8508M-S
Air Filter Primary.....	A-8508
Air Filter Primary.....	A-8508M
Air Filter Secondary.....	A-8507
Cabin Air Filter.....	CA-55850
Fuel Filter Secondary.....	FC-5515
Fuel Filter Secondary.....	FC-55151
Fuel Filter.....	FC-5516
Hydraulic Oil Filter.....	H-7942
Hydraulic Oil Filter.....	HC-5801
Oil Filter Full Flow.....	C-5510
320C FM (DELIMBERS) CAT 3066 (S/N: TBR1-UP)	
Air Filter Secondary.....	A-8507
Air Filter Primary.....	A-8508M
Air Filter Primary.....	A-8508
Air Filter Set.....	A-8508M-S
Air Filter Set.....	A-8604-S
Cabin Air Filter.....	CA-55850
Fuel Filter.....	FC-5516
Fuel Filter Secondary.....	FC-55151
Fuel Filter Secondary.....	FC-5515
Hydraulic Oil Filter.....	HC-5801
Hydraulic Oil Filter.....	H-7942
Oil Filter Full Flow.....	C-5510
320C MH (MATERIAL HANDLERS) CAT 3066 (S/N: EGA1-UP)	
Air Filter Secondary.....	A-8507
Air Filter Primary.....	A-8508M
Air Filter Primary.....	A-8508
Air Filter Set.....	A-8508M-S
Air Filter Set.....	A-8604-S
Cabin Air Filter.....	CA-55850
Fuel Filter.....	FC-5516
Fuel Filter Secondary.....	FC-55151
Fuel Filter Secondary.....	FC-5515
Hydraulic Oil Filter.....	H-5522
Hydraulic Oil Filter.....	HC-5801
Oil Filter Full Flow.....	C-5510
320C MH (MATERIAL HANDLERS) CAT 3066 (S/N: JPL1-09999-UP)	
Air Filter Set.....	A-8604-S
Air Filter Set.....	A-8508M-S
Air Filter Primary.....	A-8508
Air Filter Primary.....	A-8508M
Air Filter Secondary.....	A-8507
Cabin Air Filter.....	CA-55850
Fuel Filter Secondary.....	FC-5515
Fuel Filter Secondary.....	FC-55151
Fuel Filter.....	FC-5516
Hydraulic Oil Filter.....	HC-5801

MODEL/APPLICATION	SAKURA NO
CATERPILLAR	
Hydraulic Oil Filter.....	H-5522
Oil Filter Full Flow.....	C-5510
320C S (EXCAVATORS) CAT 3066 (S/N: EGL1-UP)	
Air Filter Set.....	A-5549M-S
Air Filter Secondary.....	A-5550
Air Filter Primary.....	A-5549
Air Filter Primary.....	A-5549M
Cabin Air Filter.....	CA-55850
Fuel Filter Secondary.....	FC-5515
Fuel Filter Secondary.....	FC-55151
Fuel Filter.....	FC-5516
Hydraulic Oil Filter.....	H-5522
Hydraulic Oil Filter.....	HC-5801
Oil Filter Full Flow.....	C-5510
320L (EXCAVATORS) CAT 3116 (S/N: 1KL1-UP)	
Air Filter Set.....	A-6118-S
Air Filter Secondary.....	A-6007
Air Filter Primary.....	A-6006
Fuel Filter.....	FC-1010
Hydraulic Oil Filter.....	HC-5801
Hydraulic Oil Filter.....	H-5505
Hydraulic Oil Filter.....	HC-5505
Oil Filter Combination.....	C-7916
Oil Filter Full Flow.....	C-5510
320L (EXCAVATORS) CAT 3116 (S/N: 3XK1-UP)	
Air Filter Primary.....	A-6006
Air Filter Secondary.....	A-6007
Air Filter Set.....	A-6118-S
Fuel Filter.....	F-5505
Fuel Filter Secondary.....	FC-5515
Fuel Filter.....	FC-5516
Fuel Filter Secondary.....	FC-55151
Hydraulic Oil Filter.....	HC-5505
Hydraulic Oil Filter.....	H-5505
Oil Filter Full Flow.....	C-5510
320L (EXCAVATORS) CAT 3116 (S/N: 4ZJ1-459-UP)	
Air Filter Set.....	A-6118-S
Air Filter Secondary.....	A-6007
Air Filter Primary.....	A-6006
Fuel Filter Secondary.....	FC-55151
Fuel Filter.....	FC-5516
Fuel Filter Secondary.....	FC-5515
Fuel Filter.....	F-5505
Hydraulic Oil Filter.....	H-5505
Hydraulic Oil Filter.....	HC-5505
Oil Filter Full Flow.....	C-5510
320L (EXCAVATORS) CAT 3116 (S/N: 4ZJ460-UP)	
Air Filter Primary.....	A-6006
Air Filter Secondary.....	A-6007
Air Filter Set.....	A-6118-S
Fuel Filter Secondary.....	FC-5515
Fuel Filter.....	FC-5516
Fuel Filter Secondary.....	FC-55151
Fuel Filter.....	FC-5516
Fuel Filter Secondary.....	FC-55151
Hydraulic Oil Filter.....	HC-5505

MODEL/APPLICATION	SAKURA NO
CATERPILLAR	
Hydraulic Oil Filter.....	H-5505
Oil Filter Full Flow.....	C-5510
Oil Filter Combination.....	C-7916
320L (EXCAVATORS) CAT 3116 (S/N: 6KM1-UP)	
Air Filter Set.....	A-6118-S
Air Filter Secondary.....	A-6007
Air Filter Primary.....	A-6006
Fuel Filter Secondary.....	FC-55151
Fuel Filter.....	FC-5516
Fuel Filter Secondary.....	FC-5515
Hydraulic Oil Filter.....	H-5505
Hydraulic Oil Filter.....	HC-5505
Oil Filter Combination.....	C-7916
Oil Filter Full Flow.....	C-5510
320L (EXCAVATORS) CAT 3116 (S/N: 7WK1-UP)	
Air Filter Primary.....	A-6006
Air Filter Secondary.....	A-6007
Air Filter Set.....	A-6118-S
Fuel Filter.....	F-5505
Fuel Filter Secondary.....	FC-5515
Fuel Filter.....	FC-5516
Fuel Filter Secondary.....	FC-55151
Hydraulic Oil Filter.....	HC-5505
Hydraulic Oil Filter.....	H-5505
Oil Filter Full Flow.....	C-5510
320L (EXCAVATORS) CAT 3116 (S/N: 8LK1-UP)	
Air Filter Set.....	A-6118-S
Air Filter Secondary.....	A-6007
Air Filter Primary.....	A-6006
Fuel Filter.....	FC-1010
Hydraulic Oil Filter.....	H-5505
Hydraulic Oil Filter.....	HC-5505
Hydraulic Oil Filter.....	HC-5801
Oil Filter Combination.....	C-7916
Oil Filter Full Flow.....	C-5510
320L (EXCAVATORS) CAT 3116 (S/N: 9WG1-722-UP)	
Air Filter Primary.....	A-6006
Air Filter Secondary.....	A-6007
Air Filter Set.....	A-6118-S
Fuel Filter.....	F-5505
Fuel Filter Secondary.....	FC-5515
Fuel Filter Secondary.....	FC-55151
Fuel Filter.....	FC-5516
Hydraulic Oil Filter.....	HC-5505
Hydraulic Oil Filter.....	H-5505
Oil Filter Full Flow.....	C-5510
320L (EXCAVATORS) CAT 3116 (S/N: 9WG723-UP)	
Air Filter Set.....	A-6118-S
Air Filter Secondary.....	A-6007
Air Filter Primary.....	A-6006
Fuel Filter.....	FC-5516
Fuel Filter Secondary.....	FC-55151
Fuel Filter Secondary.....	FC-5515
Hydraulic Oil Filter.....	H-5505

MODEL/APPLICATION	SAKURA NO	MODEL/APPLICATION	SAKURA NO	MODEL/APPLICATION	SAKURA NO
CATERPILLAR		CATERPILLAR		CATERPILLAR	
320L (EXCAVATORS) CAT 3116 (S/N: 9WG723-UP) Hydraulic Oil Filter..... HC-5505 Oil Filter Combination..... C-7916 Oil Filter Full Flow..... C-5510		Air Filter Primary..... A-8508 Air Filter Primary..... A-8508M Fuel Filter..... FC-5516 Fuel Filter Secondary..... FC-55151 Fuel Filter Secondary..... FC-5515 Hydraulic Oil Filter..... HC-5801 Hydraulic Oil Filter..... H-7942 Oil Filter Full Flow..... C-5510		Fuel Filter..... FC-5516 Fuel Filter Secondary..... FC-5515 Hydraulic Oil Filter..... H-7942 Hydraulic Oil Filter..... HC-5801 Oil Filter Full Flow..... C-5510	
320N (EXCAVATORS) S/N: 3XK822-UP Air Filter Secondary..... A-6007 Air Filter Set..... A-6118-S Air Filter Primary..... A-6006 Fuel Filter..... F-5505 Fuel Filter..... FC-5508 Fuel Filter Secondary..... FC-5515 Fuel Filter Secondary..... FC-55151 Fuel Filter..... FC-5516 Hydraulic Oil Filter..... H-5505 Hydraulic Oil Filter..... HC-5505 Hydraulic Oil Filter..... HC-55170 Oil Filter Full Flow..... C-5510		321C LCR (EXCAVATORS) CAT 3066T , 2004-UP Air Filter Primary..... A-8508M Air Filter Primary..... A-8508 Air Filter Set..... A-8508M-S Air Filter Set..... A-8604-S Air Filter Secondary..... A-8507 Fuel Filter Secondary..... FC-5515 Fuel Filter Secondary..... FC-55151 Fuel Filter..... FC-5516 Hydraulic Oil Filter..... HC-5801 Oil Filter Full Flow..... C-5510		322C (EXCAVATORS) CAT 3126 (S/N: BKJ1-UP) Air Filter Secondary..... A-8507 Air Filter Set..... A-8604-S Air Filter Set..... A-8508M-S Air Filter Primary..... A-8508 Air Filter Primary..... A-8508M Cabin Air Filter..... CA-55850 Fuel Filter..... FC-5517 Hydraulic Oil Filter..... HC-5801 Hydraulic Oil Filter..... HC-55170 Hydraulic Oil Filter..... H-7942 Oil Filter Full Flow..... C-5510	
320N (EXCAVATORS) S/N: 9WG1-UP Air Filter Primary..... A-6006 Air Filter Set..... A-6118-S Air Filter Secondary..... A-6007 Hydraulic Oil Filter..... H-5505 Oil Filter Full Flow..... C-5510		321D (EXCAVATORS) HCW1-ON Oil Filter Full Flow..... C-5506		322C (EXCAVATORS) CAT 3126 (S/N: BKM1-UP) Air Filter Primary..... A-8508M Air Filter Primary..... A-8508 Air Filter Set..... A-8508M-S Air Filter Set..... A-8604-S Air Filter Secondary..... A-8507 Air Filter Set..... A-5549M-S Air Filter Primary..... A-5549M Air Filter Primary..... A-5549 Air Filter Secondary..... A-5550	
320D2 (EXCAVATORS) C7.1 Fuel/Water Separator..... SFC-43040 Hydraulic Oil Filter Return..... EH-55040		322C (EXCAVATORS) CAT 3126B Hydraulic Oil Filter..... HC-9901		Fuel Filter..... FC-5508 Fuel Filter Secondary..... FC-55151 Fuel Filter..... FC-5516 Fuel Filter Secondary..... FC-5515 Hydraulic Oil Filter..... H-7942 Hydraulic Oil Filter..... HC-5801 Oil Filter Full Flow..... C-5510	
320D2 (EXCAVATORS) C7.1 ACERT Hydraulic Oil Filter Return..... EH-55040		322C (EXCAVATORS) CAT 3126 (S/N: BFK1-UP) Air Filter Primary..... A-5549M Air Filter Primary..... A-5549 Air Filter Secondary..... A-5550 Air Filter Set..... A-5549M-S Air Filter Secondary..... A-8507 Air Filter Set..... A-8604-S Air Filter Set..... A-8508M-S Air Filter Primary..... A-8508 Air Filter Primary..... A-8508M Cabin Air Filter..... CA-55850 Fuel Filter..... FC-5516 Fuel Filter Secondary..... FC-55151 Fuel Filter..... FC-5508 Fuel Filter Secondary..... FC-5515 Hydraulic Oil Filter..... H-7942 Hydraulic Oil Filter..... HC-5801 Oil Filter Full Flow..... C-5510		322C (EXCAVATORS) CAT 3126 (S/N: BLP1-UP) Air Filter Secondary..... A-5550 Air Filter Primary..... A-5549 Air Filter Primary..... A-5549M Air Filter Set..... A-5549M-S Air Filter Secondary..... A-8507 Air Filter Set..... A-8604-S Air Filter Set..... A-8508M-S Air Filter Primary..... A-8508 Air Filter Primary..... A-8508M Fuel Filter Secondary..... FC-5515 Fuel Filter..... FC-5516 Fuel Filter Secondary..... FC-55151 Fuel Filter..... FC-5508 Hydraulic Oil Filter..... HC-5801 Hydraulic Oil Filter..... H-7942 Oil Filter Full Flow..... C-5510	
320D2 L (EXCAVATORS) CAT C7.1 , 7100 Air Filter Set..... A-44380-S Air Filter Secondary..... A-44370 Air Filter Primary..... A-44380		Air Filter Primary..... A-8508M Air Filter Primary..... A-8508 Air Filter Set..... A-8508M-S Air Filter Set..... A-8604-S Air Filter Secondary..... A-8507 Air Filter Set..... A-5549M-S Air Filter Secondary..... A-5550 Air Filter Primary..... A-5549 Air Filter Primary..... A-5549M Cabin Air Filter..... CA-55850 Fuel Filter..... FC-5508 Fuel Filter Secondary..... FC-55151 Fuel Filter..... FC-5508 Fuel Filter Secondary..... FC-5515 Hydraulic Oil Filter..... H-7942 Hydraulic Oil Filter..... HC-5801 Oil Filter Full Flow..... C-5510		322C (EXCAVATORS) CAT 3126 (S/N: BGR1-UP) Air Filter Primary..... A-8508M Air Filter Primary..... A-8508 Air Filter Set..... A-8508M-S Air Filter Set..... A-8604-S Air Filter Secondary..... A-8507 Air Filter Set..... A-5549M-S Air Filter Secondary..... A-5550 Air Filter Primary..... A-5549 Air Filter Primary..... A-5549M Cabin Air Filter..... CA-55850 Fuel Filter..... FC-5508 Fuel Filter Secondary..... FC-55151	
320D2 L (EXCAVATORS) C7.1 Fuel/Water Separator..... SFC-43040		Air Filter Primary..... A-44380 Air Filter Secondary..... A-44370 Air Filter Set..... A-44380-S		Air Filter Primary..... A-8508 Air Filter Primary..... A-8508M Fuel Filter Secondary..... FC-5515 Fuel Filter..... FC-5516 Fuel Filter Secondary..... FC-55151 Fuel Filter..... FC-5508 Hydraulic Oil Filter..... HC-5801 Hydraulic Oil Filter..... H-7942 Oil Filter Full Flow..... C-5510	
320D2 GC (EXCAVATORS) C4.4 ACERT , 4400 Air Filter Primary..... A-44380 Air Filter Secondary..... A-44370 Air Filter Set..... A-44380-S		Hydraulic Oil Filter..... HC-9901		Air Filter Secondary..... A-8507 Air Filter Set..... A-8604-S Air Filter Set..... A-8508M-S Air Filter Primary..... A-8508 Air Filter Primary..... A-8508M Fuel Filter Secondary..... FC-5515 Fuel Filter..... FC-5516 Fuel Filter Secondary..... FC-55151 Fuel Filter..... FC-5508 Hydraulic Oil Filter..... HC-5801 Hydraulic Oil Filter..... H-7942 Oil Filter Full Flow..... C-5510	
321C (EXCAVATORS) CAT 3066T Hydraulic Oil Filter..... HC-9901		321C (EXCAVATORS) CAT 3066 (S/N: MCF1-UP) Air Filter Secondary..... A-8507 Air Filter Set..... A-8604-S Air Filter Set..... A-8508M-S		322C (EXCAVATORS) CAT 3126 (S/N: BPH1-UP) Air Filter Primary..... A-8508M Air Filter Primary..... A-8508 Air Filter Set..... A-8508M-S	

MODEL/APPLICATION	SAKURA NO
CATERPILLAR	
322C (EXCAVATORS) CAT 3126 (S/N: BPH1-UP)	
Air Filter Set.....	A-8604-S
Air Filter Secondary.....	A-8507
Cabin Air Filter.....	CA-55850
Fuel Filter Secondary.....	FC-5515
Fuel Filter.....	FC-5508
Fuel Filter Secondary.....	FC-55151
Fuel Filter.....	FC-5516
Hydraulic Oil Filter.....	H-7942
Hydraulic Oil Filter.....	HC-5801
Oil Filter Full Flow.....	C-5510
322C (EXCAVATORS) CAT 3126 (S/N: CAM1-UP)	
Air Filter Secondary.....	A-8507
Air Filter Set.....	A-8604-S
Air Filter Set.....	A-8508M-S
Air Filter Primary.....	A-8508
Air Filter Primary.....	A-8508M
Cabin Air Filter.....	CA-55850
Fuel Filter Secondary.....	FC-5515
Fuel Filter.....	FC-5516
Fuel Filter Secondary.....	FC-55151
Fuel Filter.....	FC-5508
Hydraulic Oil Filter.....	HC-5801
Hydraulic Oil Filter.....	H-7942
Oil Filter Full Flow.....	C-5510
322C (EXCAVATORS) CAT 3126 (S/N: CBY1-UP)	
Air Filter Primary.....	A-8508M
Air Filter Primary.....	A-8508
Air Filter Set.....	A-8508M-S
Air Filter Set.....	A-8604-S
Air Filter Secondary.....	A-8507
Cabin Air Filter.....	CA-55850
Fuel Filter Secondary.....	FC-55151
Fuel Filter.....	FC-5516
Fuel Filter Secondary.....	FC-5515
Hydraulic Oil Filter.....	H-7942
Hydraulic Oil Filter.....	HC-5801
Oil Filter Full Flow.....	C-5510
322C (EXCAVATORS) CAT 3126 (S/N: DAA1-UP)	
Air Filter Primary.....	A-5558
Air Filter Secondary.....	A-5559
Cabin Air Filter.....	CA-55850
Fuel Filter.....	FC-5517
Hydraulic Oil Filter.....	HC-5801
Hydraulic Oil Filter.....	H-7942
Oil Filter Full Flow.....	C-5510
322C (EXCAVATORS) CAT 3126 (S/N: EMR1-UP)	
Air Filter Secondary.....	A-5559
Air Filter Primary.....	A-5558
Cabin Air Filter.....	CA-55850
Fuel Filter.....	FC-5517
Hydraulic Oil Filter.....	H-7942
Hydraulic Oil Filter.....	HC-5801
Hydraulic Oil Filter.....	H-5522

MODEL/APPLICATION	SAKURA NO
CATERPILLAR	
Oil Filter Full Flow.....	C-5510
322C (EXCAVATORS) CAT 3126 (S/N: HEK1-UP)	
Air Filter Primary.....	A-5558
Air Filter Secondary.....	A-5559
Cabin Air Filter.....	CA-55850
Fuel Filter.....	FC-5517
Hydraulic Oil Filter.....	HC-5801
Hydraulic Oil Filter.....	H-7942
Hydraulic Oil Filter.....	HC-55170
Oil Filter Full Flow.....	C-5510
322C (EXCAVATORS) CAT 3126 (S/N: MAR1-UP)	
Air Filter Primary.....	A-5558
Air Filter Secondary.....	A-5559
Cabin Air Filter.....	CA-55850
Fuel Filter.....	FC-5517
Hydraulic Oil Filter.....	H-7942
Hydraulic Oil Filter.....	HC-5801
Hydraulic Oil Filter.....	H-5522
Oil Filter Full Flow.....	C-5510
322C (EXCAVATORS) S/N: BYL1-UP	
Air Filter Primary.....	A-5558
Air Filter Secondary.....	A-5559
Cabin Air Filter.....	CA-55850
Fuel Filter.....	FC-5517
Hydraulic Oil Filter.....	HC-5801
Hydraulic Oil Filter.....	H-7942
Hydraulic Oil Filter.....	HC-55170
Oil Filter Full Flow.....	C-5510
322C L (EXCAVATORS) CAT 3054 (S/N: BKJ1-UP)	
Air Filter Set.....	A-5549M-S
Air Filter Secondary.....	A-5550
Air Filter Primary.....	A-5549
Air Filter Primary.....	A-5549M
Air Filter Primary.....	A-8508M
Air Filter Primary.....	A-8508
Air Filter Set.....	A-8508M-S
Air Filter Set.....	A-8604-S
Air Filter Secondary.....	A-8507
Cabin Air Filter.....	CA-55850
Fuel Filter.....	FC-5508
Fuel Filter Secondary.....	FC-5515
Fuel Filter.....	FC-5516
Fuel Filter Secondary.....	FC-55151
Hydraulic Oil Filter.....	HC-55170
Hydraulic Oil Filter.....	H-7942
Hydraulic Oil Filter.....	HC-5801
Oil Filter Full Flow.....	C-5510
322C L (EXCAVATORS) CAT 3054 (S/N: BKM1-UP)	
Air Filter Secondary.....	A-8507
Air Filter Set.....	A-8604-S
Air Filter Set.....	A-8508M-S
Air Filter Primary.....	A-8508
Air Filter Primary.....	A-8508M
Air Filter Primary.....	A-5549M

MODEL/APPLICATION	SAKURA NO
CATERPILLAR	
Air Filter Primary.....	A-5549
Air Filter Secondary.....	A-5550
Air Filter Set.....	A-5549M-S
Cabin Air Filter.....	CA-55850
Fuel Filter Secondary.....	FC-5515
Fuel Filter.....	FC-5508
Fuel Filter Secondary.....	FC-55151
Fuel Filter.....	FC-5516
Hydraulic Oil Filter.....	HC-5801
Hydraulic Oil Filter.....	H-7942
Oil Filter Full Flow.....	C-5510
322C L (EXCAVATORS) CAT 3054 (S/N: BLP1-UP)	
Air Filter Set.....	A-8604-S
Air Filter Secondary.....	A-8507
Air Filter Set.....	A-5549M-S
Air Filter Secondary.....	A-5550
Air Filter Primary.....	A-5549
Air Filter Primary.....	A-5549M
Air Filter Primary.....	A-8508M
Air Filter Primary.....	A-8508
Air Filter Set.....	A-8508M-S
Cabin Air Filter.....	CA-55850
Fuel Filter.....	FC-5508
Fuel Filter Secondary.....	FC-5515
Fuel Filter Secondary.....	FC-55151
Fuel Filter.....	FC-5516
Hydraulic Oil Filter.....	HC-5801
Hydraulic Oil Filter.....	H-7942
Oil Filter Full Flow.....	C-5510
322C L (EXCAVATORS) CAT 3054 (S/N: FED1-UP)	
Air Filter Secondary.....	A-5559
Air Filter Primary.....	A-5558
Cabin Air Filter.....	CA-55850
Fuel Filter.....	FC-5517
Hydraulic Oil Filter.....	HC-5801
Hydraulic Oil Filter.....	H-7942
Oil Filter Full Flow.....	C-5510
322C L (EXCAVATORS) CAT 3126B ATAAC	
Hydraulic Oil Filter.....	HC-9901
322C LN (EXCAVATORS) S/N: EMR00297-UP , 2004-UP	
Air Filter Primary.....	A-5558
Air Filter Secondary.....	A-5559
Fuel Filter.....	FC-5517
Hydraulic Oil Filter.....	HC-5801
Hydraulic Oil Filter.....	H-5522
Oil Filter Full Flow.....	C-5510
322C LN (EXCAVATORS) CAT 3054 (S/N: BFK1-UP)	
Air Filter Primary.....	A-5549M
Air Filter Primary.....	A-5549
Air Filter Secondary.....	A-5550
Air Filter Set.....	A-5549M-S
Air Filter Secondary.....	A-8507
Air Filter Set.....	A-8604-S
Air Filter Set.....	A-8508M-S

MODEL/APPLICATION	SAKURA NO
-------------------	-----------

CATERPILLAR

322C LN (EXCAVATORS) CAT 3054 (S/N: BFK1-UP)	
Air Filter Primary.....	A-8508
Air Filter Primary.....	A-8508M
Fuel Filter.....	FC-5516
Fuel Filter Secondary.....	FC-55151
Fuel Filter Secondary.....	FC-5515
Fuel Filter.....	FC-5508
Hydraulic Oil Filter.....	H-7942
Hydraulic Oil Filter.....	HC-5801
Oil Filter Full Flow.....	C-5510
322C LN (EXCAVATORS) CAT 3054 (S/N: BGR1-UP)	
Air Filter Primary.....	A-8508M
Air Filter Primary.....	A-8508
Air Filter Set.....	A-8508M-S
Air Filter Set.....	A-8604-S
Air Filter Secondary.....	A-8507
Air Filter Set.....	A-5549M-S
Air Filter Secondary.....	A-5550
Air Filter Primary.....	A-5549
Air Filter Primary.....	A-5549M
Fuel Filter.....	FC-5508
Fuel Filter Secondary.....	FC-5515
Fuel Filter Secondary.....	FC-55151
Fuel Filter.....	FC-5516
Hydraulic Oil Filter.....	HC-5801
Hydraulic Oil Filter.....	H-7942
Oil Filter Full Flow.....	C-5510
322B (EXCAVATORS) CAT 3116 (S/N: 2E51-UP)	
Air Filter Primary.....	A-8508M
Air Filter Primary.....	A-8508
Air Filter Set.....	A-8508M-S
Air Filter Set.....	A-8604-S
Air Filter Secondary.....	A-8507
Cabin Air Filter.....	CA-55850
Fuel Filter.....	FC-5508
Fuel Filter Secondary.....	FC-5515
Fuel Filter Secondary.....	FC-55151
Fuel Filter.....	FC-5516
Hydraulic Oil Filter.....	HC-5801
Oil Filter Full Flow.....	C-5510
322B (EXCAVATORS) CAT 3116 (S/N: 8MR1-UP)	
Air Filter Secondary.....	A-8507
Air Filter Set.....	A-8604-S
Air Filter Set.....	A-8508M-S
Air Filter Primary.....	A-8508
Air Filter Primary.....	A-8508M
Air Filter Secondary.....	A-5550
Air Filter Primary.....	A-5549
Air Filter Primary.....	A-5549M
Air Filter Set.....	A-5549M-S
Cabin Air Filter.....	CA-55850
Fuel Filter Secondary.....	FC-55151
Fuel Filter Secondary.....	FC-5515
Fuel Filter.....	FC-5508
Fuel Filter.....	FC-5516

MODEL/APPLICATION	SAKURA NO
-------------------	-----------

CATERPILLAR

Hydraulic Oil Filter.....	H-7942
Hydraulic Oil Filter.....	HC-5801
Hydraulic Oil Filter.....	HC-5505
Oil Filter Full Flow.....	C-5510
322B (EXCAVATORS) CAT 3116 (S/N: 8NR1-UP)	
Air Filter Set.....	A-5549M-S
Air Filter Primary.....	A-5549M
Air Filter Primary.....	A-5549
Air Filter Secondary.....	A-5550
Air Filter Primary.....	A-8508M
Air Filter Primary.....	A-8508
Air Filter Set.....	A-8508M-S
Air Filter Set.....	A-8604-S
Air Filter Secondary.....	A-8507
Cabin Air Filter.....	CA-55850
Fuel Filter.....	FC-5508
Fuel Filter Secondary.....	FC-5515
Fuel Filter Secondary.....	FC-55151
Fuel Filter.....	FC-5516
Hydraulic Oil Filter.....	HC-5505
Hydraulic Oil Filter.....	HC-5801
Hydraulic Oil Filter.....	H-7942
Oil Filter Full Flow.....	C-5510
322L (EXCAVATORS) CAT 3116 (S/N: 4RM1-UP)	
Air Filter Set.....	A-6118-S
Air Filter Secondary.....	A-6007
Air Filter Primary.....	A-6006
Fuel Filter.....	F-5505
Fuel Filter.....	FC-5516
Fuel Filter Secondary.....	FC-55151
Fuel Filter Secondary.....	FC-5515
Fuel Filter.....	FC-5508
Hydraulic Oil Filter.....	H-5505
Hydraulic Oil Filter.....	HC-5505
Oil Filter Full Flow.....	C-5510
322L (EXCAVATORS) CAT 3116 (S/N: 7WL1-UP)	
Air Filter Primary.....	A-6006
Air Filter Secondary.....	A-6007
Air Filter Set.....	A-6118-S
Fuel Filter.....	F-5505
Fuel Filter.....	FC-5508
Fuel Filter Secondary.....	FC-5515
Fuel Filter Secondary.....	FC-55151
Fuel Filter.....	FC-5516
Hydraulic Oil Filter.....	HC-5505
Hydraulic Oil Filter.....	H-5505
Oil Filter Full Flow.....	C-5510
322L (EXCAVATORS) CAT 3116 (S/N: 8CL1-UP)	
Air Filter Set.....	A-6118-S
Air Filter Secondary.....	A-6007
Air Filter Primary.....	A-6006
Fuel Filter.....	F-5505
Fuel Filter.....	FC-5516
Fuel Filter Secondary.....	FC-55151
Fuel Filter Secondary.....	FC-5515

MODEL/APPLICATION	SAKURA NO
-------------------	-----------

CATERPILLAR

Fuel Filter.....	FC-5508
Hydraulic Oil Filter.....	H-5505
Hydraulic Oil Filter.....	HC-5505
Oil Filter Full Flow.....	C-5510
322L (EXCAVATORS) CAT 3116 (S/N: 8ML1-UP)	
Air Filter Primary.....	A-6006
Air Filter Secondary.....	A-6007
Air Filter Set.....	A-6118-S
Fuel Filter Secondary.....	FC-55151
Fuel Filter.....	FC-5516
Fuel Filter.....	FC-5508
Fuel Filter Secondary.....	FC-5515
Fuel Filter.....	F-5505
Hydraulic Oil Filter.....	HC-5505
Hydraulic Oil Filter.....	H-5505
Oil Filter Full Flow.....	C-5510
322L (EXCAVATORS) CAT 3116 (S/N: 9JL1-UP)	
Air Filter Set.....	A-6118-S
Air Filter Secondary.....	A-6007
Air Filter Primary.....	A-6006
Fuel Filter.....	F-5505
Fuel Filter.....	FC-5516
Fuel Filter Secondary.....	FC-55151
Fuel Filter Secondary.....	FC-5515
Fuel Filter.....	FC-5508
Hydraulic Oil Filter.....	H-5505
Hydraulic Oil Filter.....	HC-5505
Oil Filter Full Flow.....	C-5510
322L (EXCAVATORS) CAT 3116 (S/N: 9RL1-UP)	
Air Filter Primary.....	A-6006
Air Filter Secondary.....	A-6007
Air Filter Set.....	A-6118-S
Fuel Filter.....	F-5505
Fuel Filter.....	FC-5508
Fuel Filter Secondary.....	FC-5515
Fuel Filter Secondary.....	FC-55151
Fuel Filter.....	FC-5516
Hydraulic Oil Filter.....	HC-5505
Hydraulic Oil Filter.....	H-5505
Oil Filter Full Flow.....	C-5510
322 LN (EXCAVATORS) CAT 3116 (S/N: 4RM1-UP)	
Air Filter Primary.....	A-6006
Air Filter Secondary.....	A-6007
Air Filter Set.....	A-6118-S
Fuel Filter.....	FC-5516
Fuel Filter.....	F-5505
Fuel Filter.....	FC-5508
Fuel Filter Secondary.....	FC-5515
Fuel Filter Secondary.....	FC-55151
Hydraulic Oil Filter.....	H-5505
Hydraulic Oil Filter.....	HC-5505
Oil Filter Full Flow.....	C-5510
322 LN (EXCAVATORS) CAT 3116 (S/N: 8ML1-UP)	
Air Filter Set.....	A-6118-S

MODEL/APPLICATION	SAKURA NO
CATERPILLAR	
322 LN (EXCAVATORS) CAT 3116 (S/N: 8ML1-UP)	
Air Filter Secondary.....	A-6007
Air Filter Primary.....	A-6006
Fuel Filter Secondary.....	FC-55151
Fuel Filter Secondary.....	FC-5515
Fuel Filter.....	FC-5508
Fuel Filter.....	F-5505
Fuel Filter.....	FC-5516
Hydraulic Oil Filter.....	HC-5505
Hydraulic Oil Filter.....	H-5505
Oil Filter Full Flow.....	C-5510
322 LN (EXCAVATORS) CAT 3116 (S/N: 9JL1-UP)	
Air Filter Primary.....	A-6006
Air Filter Secondary.....	A-6007
Air Filter Set.....	A-6118-S
Fuel Filter.....	F-5505
Fuel Filter.....	FC-5508
Fuel Filter Secondary.....	FC-5515
Fuel Filter Secondary.....	FC-55151
Fuel Filter.....	FC-5516
Hydraulic Oil Filter.....	H-5505
Hydraulic Oil Filter.....	HC-5505
Oil Filter Full Flow.....	C-5510
322B L (EXCAVATORS) CAT 3054 (S/N: 1YS1-UP)	
Air Filter Secondary.....	A-8507
Air Filter Set.....	A-8604-S
Air Filter Set.....	A-8508M-S
Air Filter Primary.....	A-8508
Air Filter Primary.....	A-8508M
Cabin Air Filter.....	CA-55850
Fuel Filter.....	FC-5516
Fuel Filter Secondary.....	FC-55151
Fuel Filter Secondary.....	FC-5515
Fuel Filter.....	FC-5508
Hydraulic Oil Filter.....	HC-5505
Hydraulic Oil Filter.....	HC-5801
Oil Filter Full Flow.....	C-5510
322B L (EXCAVATORS) CAT 3116 (S/N: 1AS1-UP)	
Air Filter Set.....	A-8604-S
Air Filter Secondary.....	A-8507
Air Filter Primary.....	A-8508M
Air Filter Primary.....	A-8508
Air Filter Set.....	A-8508M-S
Fuel Filter Secondary.....	FC-5515
Fuel Filter Secondary.....	FC-55151
Fuel Filter.....	FC-5516
Hydraulic Oil Filter.....	HC-5801
Hydraulic Oil Filter.....	HC-5505
Hydraulic Oil Filter.....	H-7942
Oil Filter Full Flow.....	C-5510
322B L (EXCAVATORS) CAT 3116 (S/N: 1ES1-UP)	
Air Filter Set.....	A-8508M-S
Air Filter Primary.....	A-8508
Air Filter Primary.....	A-8508M

MODEL/APPLICATION	SAKURA NO
CATERPILLAR	
Air Filter Secondary.....	A-8507
Air Filter Set.....	A-8604-S
Fuel Filter.....	FC-5516
Fuel Filter Secondary.....	FC-55151
Fuel Filter Secondary.....	FC-5515
Hydraulic Oil Filter.....	H-7942
Hydraulic Oil Filter.....	HC-5505
Hydraulic Oil Filter.....	HC-5801
Oil Filter Full Flow.....	C-5510
322B L (EXCAVATORS) CAT 3116 (S/N: 1YS1-UP)	
Air Filter Set.....	A-8604-S
Air Filter Secondary.....	A-8507
Air Filter Primary.....	A-5549M
Air Filter Primary.....	A-5549
Air Filter Secondary.....	A-5550
Air Filter Set.....	A-5549M-S
Air Filter Primary.....	A-8508M
Air Filter Primary.....	A-8508
Air Filter Set.....	A-8508M-S
Fuel Filter Secondary.....	FC-55151
Fuel Filter.....	FC-5516
Fuel Filter Secondary.....	FC-5515
Fuel Filter.....	FC-5508
Hydraulic Oil Filter.....	HC-5801
Hydraulic Oil Filter.....	HC-5505
Hydraulic Oil Filter.....	H-7942
Oil Filter Full Flow.....	C-5510
322B L (EXCAVATORS) CAT 3116 (S/N: 1ZS1-UP)	
Air Filter Set.....	A-8508M-S
Air Filter Primary.....	A-8508
Air Filter Primary.....	A-8508M
Air Filter Set.....	A-5549M-S
Air Filter Secondary.....	A-5550
Air Filter Primary.....	A-5549
Air Filter Primary.....	A-5549M
Air Filter Secondary.....	A-8507
Air Filter Set.....	A-8604-S
Fuel Filter.....	FC-5516
Fuel Filter Secondary.....	FC-55151
Fuel Filter.....	FC-5508
Fuel Filter Secondary.....	FC-5515
Hydraulic Oil Filter.....	H-7942
Hydraulic Oil Filter.....	HC-5505
Hydraulic Oil Filter.....	HC-5801
Oil Filter Full Flow.....	C-5510
322B L (EXCAVATORS) CAT 3116 (S/N: 2ES1-UP)	
Air Filter Set.....	A-8604-S
Air Filter Secondary.....	A-8507
Air Filter Primary.....	A-5549M
Air Filter Primary.....	A-5549
Air Filter Secondary.....	A-5550
Air Filter Set.....	A-5549M-S
Air Filter Primary.....	A-8508M
Air Filter Primary.....	A-8508
Air Filter Set.....	A-8508M-S
Fuel Filter Secondary.....	FC-55151
Fuel Filter.....	FC-5516

MODEL/APPLICATION	SAKURA NO
CATERPILLAR	
Fuel Filter Secondary.....	FC-5515
Fuel Filter.....	FC-5508
Hydraulic Oil Filter.....	H-7942
Hydraulic Oil Filter.....	HC-5801
Hydraulic Oil Filter.....	HC-5505
Oil Filter Full Flow.....	C-5510
322B L (EXCAVATORS) CAT 3116 (S/N: 8MR1-UP)	
Air Filter Set.....	A-8508M-S
Air Filter Primary.....	A-8508
Air Filter Primary.....	A-8508M
Air Filter Set.....	A-5549M-S
Air Filter Primary.....	A-5549M
Air Filter Secondary.....	A-5550
Air Filter Primary.....	A-5549
Air Filter Secondary.....	A-8507
Air Filter Set.....	A-8604-S
Fuel Filter.....	FC-5508
Fuel Filter Secondary.....	FC-5515
Fuel Filter.....	FC-5516
Fuel Filter Secondary.....	FC-55151
Hydraulic Oil Filter.....	H-7942
Hydraulic Oil Filter.....	HC-5505
Hydraulic Oil Filter.....	HC-5801
Oil Filter Full Flow.....	C-5510
322B L (EXCAVATORS) CAT 3116 (S/N: 8NR1-UP)	
Air Filter Set.....	A-8604-S
Air Filter Secondary.....	A-8507
Air Filter Primary.....	A-5549
Air Filter Secondary.....	A-5550
Air Filter Primary.....	A-5549M
Air Filter Primary.....	A-8508M
Air Filter Primary.....	A-8508
Air Filter Set.....	A-8508M-S
Air Filter Set.....	A-5549M-S
Fuel Filter Secondary.....	FC-55151
Fuel Filter.....	FC-5516
Fuel Filter Secondary.....	FC-5515
Fuel Filter.....	FC-5508
Hydraulic Oil Filter.....	HC-5801
Hydraulic Oil Filter.....	HC-5505
Hydraulic Oil Filter.....	H-7942
Oil Filter Full Flow.....	C-5510
322B LN (EXCAVATORS) CAT 3116 (S/N: 1ZS1-UP)	
Air Filter Set.....	A-5549M-S
Air Filter Secondary.....	A-5550
Air Filter Primary.....	A-5549
Air Filter Primary.....	A-5549M
Air Filter Primary.....	A-8508M
Air Filter Primary.....	A-8508
Air Filter Set.....	A-8508M-S
Air Filter Set.....	A-8604-S
Air Filter Secondary.....	A-8507
Fuel Filter.....	FC-5516
Fuel Filter.....	FC-5508
Fuel Filter Secondary.....	FC-5515
Fuel Filter Secondary.....	FC-55151

MODEL/APPLICATION	SAKURA NO
CATERPILLAR	
322B LN (EXCAVATORS) CAT 3116 (S/N: 1ZS1-UP)	
Hydraulic Oil Filter.....	HC-5801
Hydraulic Oil Filter.....	H-7942
Hydraulic Oil Filter.....	HC-5505
Oil Filter Full Flow.....	C-5510
322B LN (EXCAVATORS) CAT 3116 (S/N: 2E51-UP)	
Air Filter Primary.....	A-8508M
Air Filter Primary.....	A-5549M
Air Filter Primary.....	A-5549
Air Filter Secondary.....	A-5550
Air Filter Set.....	A-5549M-S
Air Filter Secondary.....	A-8507
Air Filter Set.....	A-8604-S
Air Filter Set.....	A-8508M-S
Air Filter Primary.....	A-8508
Fuel Filter.....	FC-5516
Fuel Filter Secondary.....	FC-55151
Fuel Filter Secondary.....	FC-5515
Fuel Filter.....	FC-5508
Hydraulic Oil Filter.....	HC-5505
Hydraulic Oil Filter.....	H-7942
Hydraulic Oil Filter.....	HC-5801
Oil Filter Full Flow.....	C-5510
322C FP (EXCAVATORS) CAT 3054 (S/N: C3R1-UP)	
Air Filter Primary.....	A-5558
Air Filter Secondary.....	A-5559
Cabin Air Filter.....	CA-55850
Fuel Filter.....	FC-5517
Hydraulic Oil Filter.....	HC-55170
Hydraulic Oil Filter.....	HC-5801
Hydraulic Oil Filter.....	H-7942
Oil Filter Full Flow.....	C-5510
322C FP (EXCAVATORS) CAT 3054 (S/N: LAR1-UP)	
Air Filter Secondary.....	A-5559
Air Filter Primary.....	A-5558
Cabin Air Filter.....	CA-55850
Fuel Filter.....	FC-5517
Hydraulic Oil Filter.....	H-7942
Hydraulic Oil Filter.....	HC-5801
Hydraulic Oil Filter.....	HC-55170
Oil Filter Full Flow.....	C-5510
322C FP (EXCAVATORS) CAT 3054 (S/N: M2H1-UP)	
Air Filter Primary.....	A-5558
Air Filter Secondary.....	A-5559
Cabin Air Filter.....	CA-55850
Fuel Filter.....	FC-5517
Hydraulic Oil Filter.....	HC-55170
Hydraulic Oil Filter.....	HC-5801
Hydraulic Oil Filter.....	H-7942
Oil Filter Full Flow.....	C-5510
323D (EXCAVATORS) CAT (S/N: 7JK1-UP)	
Air Filter Secondary.....	A-8507
Air Filter Set.....	A-8604-S

MODEL/APPLICATION	SAKURA NO
CATERPILLAR	
Air Filter Set.....	A-8508M-S
Air Filter Primary.....	A-8508
Air Filter Primary.....	A-8508M
Fuel Filter.....	FC-1010
Fuel Filter.....	FC-5516
Fuel Filter Secondary.....	FC-55151
Fuel Filter Secondary.....	FC-5515
Oil Filter Full Flow.....	C-5522
Oil Filter Full Flow.....	C-5510
323D (EXCAVATORS) CAT (S/N: GDC1-UP)	
Fuel Filter Secondary.....	FC-5515
Fuel Filter Secondary.....	FC-55151
Fuel Filter.....	FC-5516
Fuel Filter Secondary.....	FC-5507
Oil Filter Full Flow.....	C-5522
Oil Filter Full Flow.....	C-5510
323D (EXCAVATORS) CAT (S/N: MAE1-UP)	
Fuel Filter.....	FC-5516
Fuel Filter Secondary.....	FC-55151
Fuel Filter Secondary.....	FC-5515
Fuel Filter.....	FC-10022
Fuel Filter.....	FC-1002
Oil Filter Full Flow.....	C-5522
Oil Filter Full Flow.....	C-5510
323D (EXCAVATORS) S/N: BYM1-UP	
Air Filter Secondary.....	A-5550
Air Filter Set.....	A-5549M-S
Air Filter Primary.....	A-5549M
Air Filter Primary.....	A-5549
Cabin Air Filter.....	CA-55850
Hydraulic Oil Filter.....	H-5522
Hydraulic Oil Filter.....	HC-5801
Hydraulic Oil Filter.....	HC-55170
323D (EXCAVATORS) S/N: CYD1-UP	
Air Filter Primary.....	A-5549
Air Filter Primary.....	A-5549M
Air Filter Set.....	A-5549M-S
Air Filter Secondary.....	A-5550
Cabin Air Filter.....	CA-55850
Hydraulic Oil Filter.....	HC-55170
Hydraulic Oil Filter.....	HC-5801
Hydraulic Oil Filter.....	H-5522
323D (EXCAVATORS) S/N: DKW1-UP	
Air Filter Secondary.....	A-5550
Air Filter Set.....	A-5549M-S
Air Filter Primary.....	A-5549M
Air Filter Primary.....	A-5549
Cabin Air Filter.....	CA-55850
Hydraulic Oil Filter.....	H-5522
Hydraulic Oil Filter.....	HC-5801
Hydraulic Oil Filter.....	HC-55170
323D (EXCAVATORS) S/N: JLG1-UP	

MODEL/APPLICATION	SAKURA NO
CATERPILLAR	
Air Filter Primary.....	A-5549
Air Filter Primary.....	A-5549M
Air Filter Set.....	A-5549M-S
Air Filter Secondary.....	A-5550
Cabin Air Filter.....	CA-55850
Hydraulic Oil Filter.....	H-5522
Hydraulic Oil Filter.....	HC-55170
Hydraulic Oil Filter.....	HC-5801
323D (EXCAVATORS) S/N: PBM1-UP	
Air Filter Secondary.....	A-5550
Air Filter Set.....	A-5549M-S
Air Filter Primary.....	A-5549M
Air Filter Primary.....	A-5549
Cabin Air Filter.....	CA-55850
Hydraulic Oil Filter.....	H-5522
Hydraulic Oil Filter.....	HC-5801
Hydraulic Oil Filter.....	HC-55170
323D (EXCAVATORS) S/N: RAC1-UP	
Air Filter Primary.....	A-5549
Air Filter Primary.....	A-5549M
Air Filter Set.....	A-5549M-S
Air Filter Secondary.....	A-5550
Cabin Air Filter.....	CA-55850
Hydraulic Oil Filter.....	HC-55170
Hydraulic Oil Filter.....	HC-5801
Hydraulic Oil Filter.....	H-5522
323D (EXCAVATORS) S/N: SDC1-UP	
Air Filter Secondary.....	A-5550
Air Filter Set.....	A-5549M-S
Air Filter Primary.....	A-5549M
Air Filter Primary.....	A-5549
Cabin Air Filter.....	CA-55850
Hydraulic Oil Filter.....	H-5522
Hydraulic Oil Filter.....	HC-5801
Hydraulic Oil Filter.....	HC-55170
323D (EXCAVATORS) S/N: SED1-UP	
Air Filter Primary.....	A-5549
Air Filter Primary.....	A-5549M
Air Filter Set.....	A-5549M-S
Air Filter Secondary.....	A-5550
Cabin Air Filter.....	CA-55850
Hydraulic Oil Filter.....	H-5522
Hydraulic Oil Filter.....	HC-55170
Hydraulic Oil Filter.....	HC-5801
324D (EXCAVATORS) CAT S/N: C7C1-UP , 2006-UP	
Air Filter.....	A-5584
Air Filter Primary.....	A-5558
Air Filter Secondary.....	A-5559
Cabin Air Filter.....	CA-55850
Fuel Filter.....	FC-5517
Hydraulic Oil Filter.....	H-5522
Hydraulic Oil Filter.....	HC-55170
Hydraulic Oil Filter.....	HC-5801
Oil Filter Full Flow.....	C-5522

MODEL/APPLICATION	SAKURA NO
CATERPILLAR	
324D (EXCAVATORS) CAT S/N: CJX1-UP , 2006-UP	
Air Filter Secondary.....	A-5559
Air Filter Primary.....	A-5558
Cabin Air Filter.....	CA-55850
Fuel Filter.....	FC-5517
Hydraulic Oil Filter.....	HC-5801
Hydraulic Oil Filter.....	HC-55170
Hydraulic Oil Filter.....	H-5522
Oil Filter Full Flow.....	C-5522
324D (EXCAVATORS) CAT S/N: DFP1-UP , 2006-UP	
Air Filter Primary.....	A-5558
Air Filter Secondary.....	A-5559
Cabin Air Filter.....	CA-55850
Fuel Filter.....	FC-5517
Hydraulic Oil Filter.....	H-5522
Hydraulic Oil Filter.....	HC-55170
Hydraulic Oil Filter.....	HC-5801
Oil Filter Full Flow.....	C-5522
324D (EXCAVATORS) CAT S/N: EJC1-UP , 2006-UP	
Air Filter Secondary.....	A-5559
Air Filter Primary.....	A-5558
Cabin Air Filter.....	CA-55850
Fuel Filter.....	FC-5517
Hydraulic Oil Filter.....	H-5522
Hydraulic Oil Filter.....	HC-5801
Hydraulic Oil Filter.....	HC-55170
Oil Filter Full Flow.....	C-5522
324D (EXCAVATORS) CAT S/N: JGK1-UP , 2006-UP	
Air Filter.....	A-5584
Air Filter Primary.....	A-5558
Air Filter Secondary.....	A-5559
Fuel Filter.....	FC-5517
Hydraulic Oil Filter.....	H-5522
Hydraulic Oil Filter.....	HC-5801
Hydraulic Oil Filter.....	HC-55170
Oil Filter Full Flow.....	C-5522
324D (EXCAVATORS) CAT S/N: JJG1-384-UP , 2006-UP	
Air Filter Secondary.....	A-5559
Air Filter Primary.....	A-5558
Cabin Air Filter.....	CA-55850
Fuel Filter.....	FC-5517
Hydraulic Oil Filter.....	HC-5801
Hydraulic Oil Filter.....	HC-55170
Hydraulic Oil Filter.....	H-5522
Oil Filter Full Flow.....	C-5522
324D (EXCAVATORS) CAT S/N: JJG385-UP , 2006-UP	
Air Filter Primary.....	A-5558
Air Filter Secondary.....	A-5559
Cabin Air Filter.....	CA-55850
Fuel Filter.....	FC-5517
Hydraulic Oil Filter.....	H-5522
Hydraulic Oil Filter.....	HC-55170

MODEL/APPLICATION	SAKURA NO
CATERPILLAR	
Hydraulic Oil Filter.....	HC-5801
Oil Filter Full Flow.....	C-5522
324D (EXCAVATORS) CAT S/N: JKR1-178-UP , 2006-UP	
Air Filter Secondary.....	A-5559
Air Filter Primary.....	A-5558
Air Filter.....	A-5584
Fuel Filter.....	FC-5517
Hydraulic Oil Filter.....	HC-5801
Hydraulic Oil Filter.....	HC-55170
Hydraulic Oil Filter.....	H-5522
Oil Filter Full Flow.....	C-5522
324D (EXCAVATORS) CAT S/N: JKR179-UP , 2006-UP	
Air Filter.....	A-5584
Air Filter Primary.....	A-5558
Air Filter Secondary.....	A-5559
Fuel Filter.....	FC-5517
Hydraulic Oil Filter.....	H-5522
Hydraulic Oil Filter.....	HC-5801
Oil Filter Full Flow.....	C-5522
324D (EXCAVATORS) CAT S/N: JLS1-174-UP , 2006-UP	
Air Filter Secondary.....	A-5559
Air Filter Primary.....	A-5558
Air Filter.....	A-5584
Fuel Filter.....	FC-5517
Hydraulic Oil Filter.....	HC-5801
Hydraulic Oil Filter.....	HC-55170
Hydraulic Oil Filter.....	H-5522
Oil Filter Full Flow.....	C-5522
324D (EXCAVATORS) CAT S/N: JLS175-UP , 2006-UP	
Air Filter.....	A-5584
Air Filter Primary.....	A-5558
Air Filter Secondary.....	A-5559
Fuel Filter.....	FC-5517
Hydraulic Oil Filter.....	H-5522
Hydraulic Oil Filter.....	HC-5801
Oil Filter Full Flow.....	C-5522
324D (EXCAVATORS) CAT S/N: KHX1-UP , 2006-UP	
Air Filter Secondary.....	A-5559
Air Filter Primary.....	A-5558
Air Filter.....	A-5584
Cabin Air Filter.....	CA-55850
Fuel Filter.....	FC-5517
Hydraulic Oil Filter.....	HC-5801
Hydraulic Oil Filter.....	H-5522
Hydraulic Oil Filter.....	HC-55170
Oil Filter Full Flow.....	C-5522
324D (EXCAVATORS) CAT S/N: LAB1-UP , 2006-UP	
Air Filter Primary.....	A-5558
Air Filter Secondary.....	A-5559
Cabin Air Filter.....	CA-55850
Fuel Filter.....	FC-5517
Hydraulic Oil Filter.....	H-5522
Hydraulic Oil Filter.....	HC-55170

MODEL/APPLICATION	SAKURA NO
CATERPILLAR	
Hydraulic Oil Filter.....	HC-5801
Oil Filter Full Flow.....	C-5522
324D (EXCAVATORS) CAT S/N: SYM1-UP , 2006-UP	
Air Filter Secondary.....	A-5559
Air Filter Primary.....	A-5558
Cabin Air Filter.....	CA-55850
Fuel Filter.....	FC-5517
Hydraulic Oil Filter.....	H-5522
Hydraulic Oil Filter.....	HC-5801
Hydraulic Oil Filter.....	HC-55170
Oil Filter Full Flow.....	C-5522
324D (EXCAVATORS) CAT S/N: T2D1-UP , 2006-UP	
Air Filter Primary.....	A-5558
Air Filter Secondary.....	A-5559
Cabin Air Filter.....	CA-55850
Fuel Filter.....	FC-5517
Hydraulic Oil Filter.....	H-5522
Hydraulic Oil Filter.....	HC-55170
Hydraulic Oil Filter.....	HC-5801
Oil Filter Full Flow.....	C-5522
324D (EXCAVATORS) CAT C7 ACERT	
Hydraulic Oil Filter.....	HC-9901
325 (EXCAVATORS) CAT 3116 (S/N: 2JK1-UP)	
Air Filter Set.....	A-6118-S
Air Filter Secondary.....	A-6007
Air Filter Primary.....	A-6006
Fuel Filter Secondary.....	FC-5515
Fuel Filter.....	FC-55151
Fuel Filter.....	F-5505
Fuel Filter.....	FC-5516
Hydraulic Oil Filter.....	H-5505
Hydraulic Oil Filter.....	HC-5505
Oil Filter Full Flow.....	C-5510
325 (EXCAVATORS) CAT 3116 (S/N: 2SK1-UP)	
Air Filter Primary.....	A-6006
Air Filter Secondary.....	A-6007
Air Filter Set.....	A-6118-S
Fuel Filter.....	FC-5516
Fuel Filter Secondary.....	FC-55151
Fuel Filter.....	F-5505
Hydraulic Oil Filter.....	HC-5505
Hydraulic Oil Filter.....	H-5505
Oil Filter Full Flow.....	C-5510
325 (EXCAVATORS) CAT 3116 (S/N: 2SL1-UP)	
Air Filter Set.....	A-6118-S
Air Filter Secondary.....	A-6007
Air Filter Primary.....	A-6006
Fuel Filter Secondary.....	FC-5515
Fuel Filter.....	FC-55151
Fuel Filter.....	F-5505
Fuel Filter.....	FC-5516

MODEL/APPLICATION	SAKURA NO	MODEL/APPLICATION	SAKURA NO	MODEL/APPLICATION	SAKURA NO
CATERPILLAR		CATERPILLAR		CATERPILLAR	
325 (EXCAVATORS) CAT 3116 (S/N: 9ZK1-UP)		Hydraulic Oil Filter..... HC-5505 Oil Filter Full Flow..... C-5510		325B (EXCAVATORS) S/N: 4DS-UP	
Air Filter Primary.....	A-6006	325B (EXCAVATORS) CAT 3116 (S/N: 8FN1-UP)		Air Filter Set.....	A-5549M-S
Air Filter Secondary.....	A-6007	Air Filter Primary.....	A-5549M	Air Filter Secondary.....	A-5550
Air Filter Set.....	A-6118-S	Air Filter Primary.....	A-5549	Air Filter Primary.....	A-5549
Fuel Filter.....	FC-5516	Air Filter Secondary.....	A-5550	Air Filter Primary.....	A-5549M
Fuel Filter Secondary.....	FC-55151	Air Filter Set.....	A-5549M-S	Fuel Filter.....	FC-5516
Fuel Filter Secondary.....	FC-5515	Air Filter Secondary.....	A-8507	Fuel Filter Secondary.....	FC-5515
Fuel Filter.....	F-5505	Air Filter Secondary.....	A-8508M	Fuel Filter Secondary.....	FC-55151
Hydraulic Oil Filter.....	HC-5505	Air Filter Primary.....	A-8508M	Hydraulic Oil Filter.....	H-5510
Hydraulic Oil Filter.....	H-5505	Air Filter Primary.....	A-8508	Oil Filter Full Flow.....	C-5510
Hydraulic Oil Filter.....	HC-5505	Air Filter Set.....	A-8508M-S	325B (EXCAVATORS) S/N: 6DN00657-UP	
Oil Filter Full Flow.....	C-5510	Air Filter Set.....	A-8604-S	Air Filter Primary.....	A-5549M
325 (EXCAVATORS)		Fuel Filter.....	FC-5508	Air Filter Primary.....	A-5549
Air Filter Secondary.....	A-6007	Fuel Filter Secondary.....	FC-55151	Air Filter Secondary.....	A-5550
Oil Filter Full Flow.....	C-7105	Fuel Filter Secondary.....	FC-5515	Air Filter Set.....	A-5549M-S
325 (EXCAVATORS) S/N: 25L00935-UP		Fuel Filter.....	FC-5516	Fuel Filter Secondary.....	FC-55151
Air Filter Set.....	A-6118-S	Hydraulic Oil Filter.....	HC-5801	Fuel Filter Secondary.....	FC-5515
Air Filter Secondary.....	A-6007	Hydraulic Oil Filter.....	H-7942	Fuel Filter.....	FC-5516
Air Filter Primary.....	A-6006	Hydraulic Oil Filter.....	HC-5505	Hydraulic Oil Filter.....	H-5510
Cabin Air Filter.....	CA-55850	Oil Filter Full Flow.....	C-5510	Oil Filter Full Flow.....	C-5510
Fuel Filter.....	FC-5516	325B (EXCAVATORS) CAT 3116 (S/N: 8PR1-UP)		325B (EXCAVATORS) S/N: 8FN-UP	
Fuel Filter Secondary.....	FC-5515	Air Filter Set.....	A-8508M-S	Air Filter Set.....	A-5549M-S
Fuel Filter Secondary.....	FC-55151	Air Filter Primary.....	A-8508	Air Filter Secondary.....	A-5550
Hydraulic Oil Filter.....	H-5505	Air Filter Primary.....	A-8508M	Air Filter Primary.....	A-5549
Hydraulic Oil Filter.....	H-5503	Air Filter Secondary.....	A-8507	Air Filter Primary.....	A-5549M
Hydraulic Oil Filter.....	HC-5505	Air Filter Set.....	A-5549M-S	Fuel Filter.....	FC-5516
Oil Filter Full Flow.....	C-5510	Air Filter Secondary.....	A-5550	Fuel Filter Secondary.....	FC-5515
325B (EXCAVATORS) CAT 3116 (S/N: 2JR1-UP)		Air Filter Primary.....	A-5549	Fuel Filter Secondary.....	FC-55151
Air Filter Secondary.....	A-8507	Air Filter Set.....	A-8604-S	Hydraulic Oil Filter.....	H-5510
Air Filter Primary.....	A-8508M	Fuel Filter Secondary.....	FC-5515	Oil Filter Full Flow.....	C-5510
Air Filter Primary.....	A-8508	Fuel Filter Secondary.....	FC-55151	325B (EXCAVATORS) S/N: 8GM1-UP	
Air Filter Set.....	A-8508M-S	Fuel Filter.....	FC-5508	Oil Filter Full Flow.....	C-5510
Air Filter Set.....	A-8604-S	Fuel Filter.....	FC-5516	325B L (EXCAVATORS) CAT 3116 (S/N: 1GS1-UP)	
Fuel Filter.....	FC-5508	Hydraulic Oil Filter.....	HC-5505	Air Filter Set.....	A-8604-S
Fuel Filter Secondary.....	FC-55151	Hydraulic Oil Filter.....	H-7942	Air Filter Set.....	A-8508M-S
Fuel Filter Secondary.....	FC-5515	Hydraulic Oil Filter.....	HC-5801	Air Filter Primary.....	A-8508
Fuel Filter.....	FC-5516	Oil Filter Full Flow.....	C-5510	Air Filter Primary.....	A-8508M
Hydraulic Oil Filter.....	HC-5505	325B (EXCAVATORS) CAT 3116 (S/N: 8RR1-UP)		Air Filter Secondary.....	A-8507
Oil Filter Full Flow.....	C-5510	Air Filter Primary.....	A-5549M	Fuel Filter.....	FC-5516
325B (EXCAVATORS) CAT 3116 (S/N: 6DN1-UP)		Air Filter Primary.....	A-5549	Fuel Filter Secondary.....	FC-5515
Air Filter Set.....	A-8604-S	Air Filter Secondary.....	A-5550	Fuel Filter Secondary.....	FC-55151
Air Filter Set.....	A-8508M-S	Air Filter Set.....	A-5549M-S	Fuel Filter.....	FC-5508
Air Filter Primary.....	A-8508	Air Filter Secondary.....	A-8507	Fuel Filter Secondary.....	FC-55151
Air Filter Primary.....	A-8508M	Air Filter Primary.....	A-8508M	Fuel Filter.....	FC-5508
Air Filter Primary.....	A-8508M	Air Filter Primary.....	A-8508	Hydraulic Oil Filter.....	HC-5801
Air Filter Secondary.....	A-8507	Air Filter Primary.....	A-8508M	Hydraulic Oil Filter.....	HC-5505
Air Filter Set.....	A-5549M-S	Air Filter Set.....	A-8508M-S	Hydraulic Oil Filter.....	H-7942
Air Filter Secondary.....	A-5550	Air Filter Set.....	A-8604-S	Oil Filter Full Flow.....	C-5510
Air Filter Primary.....	A-5549	Fuel Filter.....	FC-5508	325B L (EXCAVATORS) CAT 3116 (S/N: 2JR1-UP)	
Air Filter Primary.....	A-5549M	Fuel Filter Secondary.....	FC-55151	Air Filter Primary.....	A-5549M
Fuel Filter Secondary.....	FC-5515	Fuel Filter Secondary.....	FC-5515	Air Filter Primary.....	A-5549
Fuel Filter Secondary.....	FC-55151	Fuel Filter.....	FC-5516	Air Filter Secondary.....	A-8507
Fuel Filter.....	FC-5508	Hydraulic Oil Filter.....	HC-5505	Air Filter Primary.....	A-8508M
Fuel Filter.....	FC-5516	Hydraulic Oil Filter.....	HC-5801	Air Filter Primary.....	A-8508
Hydraulic Oil Filter.....	H-7942	Hydraulic Oil Filter.....	H-7942		
Hydraulic Oil Filter.....	HC-5801	Oil Filter Full Flow.....	C-5510		

MODEL/APPLICATION	SAKURA NO
CATERPILLAR	
325B L (EXCAVATORS) CAT 3116 (S/N: 2JRI-UP)	
Air Filter Set.....	A-8508M-S
Air Filter Set.....	A-8604-S
Air Filter Secondary.....	A-5550
Air Filter Set.....	A-5549M-S
Fuel Filter.....	FC-5508
Fuel Filter Secondary.....	FC-55151
Fuel Filter Secondary.....	FC-5515
Fuel Filter.....	FC-5516
Hydraulic Oil Filter.....	H-7942
Hydraulic Oil Filter.....	HC-5505
Hydraulic Oil Filter.....	HC-5801
Oil Filter Full Flow.....	C-5510
325B L (EXCAVATORS) CAT 3116 (S/N: 4DS1-UP)	
Air Filter Primary.....	A-5549
Air Filter Primary.....	A-5549M
Air Filter Set.....	A-5549M-S
Air Filter Secondary.....	A-5550
Air Filter Set.....	A-8604-S
Air Filter Set.....	A-8508M-S
Air Filter Primary.....	A-8508
Air Filter Primary.....	A-8508M
Air Filter Secondary.....	A-8507
Fuel Filter.....	FC-5516
Fuel Filter Secondary.....	FC-5515
Fuel Filter Secondary.....	FC-55151
Fuel Filter.....	FC-5508
Hydraulic Oil Filter.....	HC-5801
Hydraulic Oil Filter.....	HC-5505
Hydraulic Oil Filter.....	H-7942
Oil Filter Full Flow.....	C-5510
325B L (EXCAVATORS) CAT 3116 (S/N: 5BS1-UP)	
Air Filter Secondary.....	A-8507
Air Filter Primary.....	A-8508M
Air Filter Primary.....	A-8508
Air Filter Set.....	A-8508M-S
Air Filter Set.....	A-8604-S
Air Filter Secondary.....	A-5550
Air Filter Set.....	A-5549M-S
Air Filter Primary.....	A-5549M
Air Filter Primary.....	A-5549
Fuel Filter.....	FC-5508
Fuel Filter Secondary.....	FC-55151
Fuel Filter Secondary.....	FC-5515
Fuel Filter.....	FC-5516
Hydraulic Oil Filter.....	H-7942
Hydraulic Oil Filter.....	HC-5505
Hydraulic Oil Filter.....	HC-5801
Oil Filter Full Flow.....	C-5510
325B L (EXCAVATORS) CAT 3116 (S/N: 6DN1-UP)	
Air Filter Set.....	A-8604-S
Air Filter Set.....	A-8508M-S
Air Filter Primary.....	A-8508
Air Filter Primary.....	A-8508M
Air Filter Secondary.....	A-8507

MODEL/APPLICATION	SAKURA NO
CATERPILLAR	
Cabin Air Filter.....	CA-55850
Fuel Filter.....	FC-5516
Fuel Filter Secondary.....	FC-5515
Fuel Filter Secondary.....	FC-55151
Fuel Filter.....	FC-5508
Hydraulic Oil Filter.....	HC-5801
Hydraulic Oil Filter.....	HC-5505
Hydraulic Oil Filter.....	H-7942
Oil Filter Full Flow.....	C-5510
325B L (EXCAVATORS) CAT 3116 (S/N: 8FN1-UP)	
Air Filter Primary.....	A-8508
Air Filter Set.....	A-8508M-S
Air Filter Set.....	A-8604-S
Air Filter Secondary.....	A-8507
Air Filter Primary.....	A-8508M
Cabin Air Filter.....	CA-55850
Fuel Filter.....	FC-5508
Fuel Filter Secondary.....	FC-55151
Fuel Filter Secondary.....	FC-5515
Fuel Filter.....	FC-5516
Hydraulic Oil Filter.....	HC-5801
Hydraulic Oil Filter.....	H-7942
Hydraulic Oil Filter.....	HC-5505
Oil Filter Full Flow.....	C-5510
325B L (EXCAVATORS) CAT 3116 (S/N: 8PR1-UP)	
Air Filter Primary.....	A-8508M
Air Filter Secondary.....	A-8507
Air Filter Primary.....	A-5549
Air Filter Primary.....	A-5549M
Air Filter Set.....	A-8604-S
Air Filter Set.....	A-5549M-S
Air Filter Secondary.....	A-5550
Air Filter Set.....	A-8508M-S
Air Filter Primary.....	A-8508
Fuel Filter.....	FC-5516
Fuel Filter Secondary.....	FC-5515
Fuel Filter Secondary.....	FC-55151
Fuel Filter.....	FC-5508
Hydraulic Oil Filter.....	HC-5801
Hydraulic Oil Filter.....	HC-5505
Hydraulic Oil Filter.....	H-7942
Oil Filter Full Flow.....	C-5510
325B L (EXCAVATORS) CAT 3116 (S/N: 8RR1-UP)	
Air Filter Primary.....	A-8508
Air Filter Set.....	A-8508M-S
Air Filter Secondary.....	A-5550
Air Filter Set.....	A-5549M-S
Air Filter Set.....	A-8604-S
Air Filter Primary.....	A-5549M
Air Filter Primary.....	A-5549
Air Filter Secondary.....	A-8507
Air Filter Primary.....	A-8508M
Fuel Filter.....	FC-5508
Fuel Filter Secondary.....	FC-55151
Fuel Filter Secondary.....	FC-5515
Fuel Filter.....	FC-5516
Hydraulic Oil Filter.....	HC-5801

MODEL/APPLICATION	SAKURA NO
CATERPILLAR	
Hydraulic Oil Filter.....	H-7942
Hydraulic Oil Filter.....	HC-5505
Oil Filter Full Flow.....	C-5510
325C (EXCAVATORS) CAT 3126B	
Hydraulic Oil Filter.....	HC-9901
325C (EXCAVATORS) CAT 3126 (S/N: AMH1-UP)	
Air Filter Primary.....	A-5558
Air Filter Secondary.....	A-5559
Cabin Air Filter.....	CA-55850
Fuel Filter.....	FC-5517
Hydraulic Oil Filter.....	HC-55170
Hydraulic Oil Filter.....	H-7942
Hydraulic Oil Filter.....	HC-5801
Oil Filter Full Flow.....	C-5510
325C (EXCAVATORS) CAT 3126 (S/N: BFE1-474-UP)	
Air Filter Secondary.....	A-5559
Air Filter Primary.....	A-5558
Cabin Air Filter.....	CA-55850
Fuel Filter.....	FC-5517
Hydraulic Oil Filter.....	HC-55170
Hydraulic Oil Filter.....	HC-5801
Hydraulic Oil Filter.....	H-7942
Oil Filter Full Flow.....	C-5510
325C (EXCAVATORS) CAT 3126 (S/N: BFE1-UP)	
Air Filter Primary.....	A-5558
Air Filter Secondary.....	A-5559
Cabin Air Filter.....	CA-55850
Fuel Filter.....	FC-5517
Hydraulic Oil Filter.....	HC-55170
Hydraulic Oil Filter.....	HC-5801
Hydraulic Oil Filter.....	H-7942
Oil Filter Full Flow.....	C-5510
325C (EXCAVATORS) CAT 3126 (S/N: BFE475-UP)	
Air Filter Secondary.....	A-5559
Air Filter Primary.....	A-5558
Cabin Air Filter.....	CA-55850
Fuel Filter.....	FC-5517
Hydraulic Oil Filter.....	HC-55170
Hydraulic Oil Filter.....	HC-5801
Hydraulic Oil Filter.....	H-7942
Oil Filter Full Flow.....	C-5510
325C (EXCAVATORS) CAT 3126 (S/N: BKM1-UP)	
Air Filter Primary.....	A-5558
Air Filter Secondary.....	A-5559
Cabin Air Filter.....	CA-55850
Fuel Filter.....	FC-5517
Hydraulic Oil Filter.....	H-7942
Hydraulic Oil Filter.....	HC-5801
Oil Filter Full Flow.....	C-5510
325C (EXCAVATORS) CAT 3126 (S/N: BMM1-UP)	
Air Filter Secondary.....	A-5559

MODEL/APPLICATION	SAKURA NO
CATERPILLAR	
325C (EXCAVATORS) CAT 3126 (S/N: BMM1-UP)	
Air Filter Primary.....	A-5558
Cabin Air Filter.....	CA-55850
Fuel Filter.....	FC-5517
Hydraulic Oil Filter.....	HC-5801
Hydraulic Oil Filter.....	H-7942
Oil Filter Full Flow.....	C-5510
325C (EXCAVATORS) CAT 3126 (S/N: BTD1-UP)	
Air Filter Primary.....	A-5558
Air Filter Secondary.....	A-5559
Cabin Air Filter.....	CA-55850
Fuel Filter.....	FC-5517
Hydraulic Oil Filter.....	HC-55170
Hydraulic Oil Filter.....	H-7942
Hydraulic Oil Filter.....	HC-5801
Oil Filter Full Flow.....	C-5510
325C (EXCAVATORS) CAT 3126 (S/N: CRB1-UP)	
Air Filter Secondary.....	A-5559
Air Filter Primary.....	A-5558
Cabin Air Filter.....	CA-55850
Fuel Filter.....	FC-5517
Hydraulic Oil Filter.....	H-5522
Hydraulic Oil Filter.....	HC-5801
Oil Filter Full Flow.....	C-5510
325C (EXCAVATORS) CAT 3126 (S/N: CSJ1-UP)	
Air Filter Primary.....	A-5558
Air Filter Secondary.....	A-5559
Cabin Air Filter.....	CA-55850
Fuel Filter.....	FC-5517
Hydraulic Oil Filter.....	H-5522
Hydraulic Oil Filter.....	HC-5801
Oil Filter Full Flow.....	C-5510
325C (EXCAVATORS) CAT 3126 (S/N: DTF1-UP)	
Air Filter Secondary.....	A-5559
Air Filter Primary.....	A-5558
Cabin Air Filter.....	CA-55850
Fuel Filter.....	FC-5517
Hydraulic Oil Filter.....	H-5522
Hydraulic Oil Filter.....	HC-5801
Oil Filter Full Flow.....	C-5510
325C (EXCAVATORS) CAT 3126 (S/N: J1C1-UP)	
Air Filter Primary.....	A-5558
Air Filter Secondary.....	A-5559
Cabin Air Filter.....	CA-55850
Fuel Filter.....	FC-5517
Hydraulic Oil Filter.....	H-5522
Hydraulic Oil Filter.....	HC-5801
Oil Filter Full Flow.....	C-5510
325C (EXCAVATORS) CAT 3126 (S/N: JLD1-UP)	
Air Filter Secondary.....	A-5559
Air Filter Primary.....	A-5558

MODEL/APPLICATION	SAKURA NO
CATERPILLAR	
Cabin Air Filter.....	CA-55850
Fuel Filter.....	FC-5517
Hydraulic Oil Filter.....	H-5522
Hydraulic Oil Filter.....	HC-5801
Oil Filter Full Flow.....	C-5510
325C (EXCAVATORS) CAT 3126 (S/N: S2C1-UP)	
Air Filter Primary.....	A-5558
Air Filter Secondary.....	A-5559
Cabin Air Filter.....	CA-55850
Fuel Filter.....	FC-5517
Hydraulic Oil Filter.....	HC-55170
Hydraulic Oil Filter.....	HC-5801
Hydraulic Oil Filter.....	H-7942
Oil Filter Full Flow.....	C-5510
325C L (EXCAVATORS) CAT 3126B	
Hydraulic Oil Filter.....	HC-9901
325C L (EXCAVATORS) CAT 3116 (S/N: BFE1-UP)	
Air Filter Secondary.....	A-5559
Air Filter Primary.....	A-5558
Fuel Filter.....	FC-5517
Hydraulic Oil Filter.....	HC-55170
Hydraulic Oil Filter.....	HC-5801
Hydraulic Oil Filter.....	H-7942
Oil Filter Full Flow.....	C-5510
325C L (EXCAVATORS) CAT 3126 (S/N: BKW1-UP)	
Air Filter Primary.....	A-5558
Air Filter Secondary.....	A-5559
Fuel Filter.....	FC-5517
Hydraulic Oil Filter.....	H-7942
Hydraulic Oil Filter.....	HC-5801
Oil Filter Full Flow.....	C-5510
325C L (EXCAVATORS) CAT 3126 (S/N: BMM1-UP)	
Air Filter Secondary.....	A-5559
Air Filter Primary.....	A-5558
Fuel Filter.....	FC-5517
Hydraulic Oil Filter.....	HC-5801
Hydraulic Oil Filter.....	H-7942
Oil Filter Full Flow.....	C-5510
325C L (EXCAVATORS) CAT 3126 (S/N: CRB1-UP)	
Air Filter Primary.....	A-5558
Air Filter Secondary.....	A-5559
Fuel Filter.....	FC-5517
Hydraulic Oil Filter.....	H-7942
Hydraulic Oil Filter.....	HC-5801
Oil Filter Full Flow.....	C-5510
325C L (EXCAVATORS) CAT 3126 (S/N: CSJ1-UP)	
Air Filter Secondary.....	A-5559
Air Filter Primary.....	A-5558
Fuel Filter.....	FC-5517
Hydraulic Oil Filter.....	H-7942
Hydraulic Oil Filter.....	HC-5801
Oil Filter Full Flow.....	C-5510
325C L (EXCAVATORS) CAT 3126 (S/N: J1C1-UP)	
Air Filter Secondary.....	A-5559
Air Filter Primary.....	A-5558
Fuel Filter.....	FC-5517
Hydraulic Oil Filter.....	HC-5801
Hydraulic Oil Filter.....	H-7942

MODEL/APPLICATION	SAKURA NO
CATERPILLAR	
Oil Filter Full Flow.....	C-5510
325C LN (EXCAVATORS) CAT 3116 (S/N: CRB1-UP)	
Air Filter Primary.....	A-5558
Air Filter Secondary.....	A-5559
Fuel Filter.....	FC-5517
Hydraulic Oil Filter.....	H-7942
Hydraulic Oil Filter.....	HC-5801
Oil Filter Full Flow.....	C-5510
325L (EXCAVATORS) CAT 3116 (S/N: 2JK1-UP)	
Air Filter Primary.....	A-6006
Air Filter Secondary.....	A-6007
Air Filter Set.....	A-6118-S
Cabin Air Filter.....	CA-55850
Fuel Filter.....	F-5505
Fuel Filter.....	FC-5516
Fuel Filter Secondary.....	FC-55151
Fuel Filter Secondary.....	FC-5515
Fuel Filter.....	FC-5508
Fuel Filter Secondary.....	FC-5507
Hydraulic Oil Filter.....	HC-5505
Hydraulic Oil Filter.....	H-5505
Oil Filter Full Flow.....	C-5510
325L (EXCAVATORS) CAT 3116 (S/N: 2SK1-UP)	
Air Filter Set.....	A-6118-S
Air Filter Secondary.....	A-6007
Air Filter Primary.....	A-6006
Cabin Air Filter.....	CA-55850
Fuel Filter.....	F-5505
Fuel Filter.....	FC-5508
Fuel Filter Secondary.....	FC-5515
Fuel Filter Secondary.....	FC-55151
Fuel Filter.....	FC-5516
Fuel Filter Secondary.....	FC-5507
Hydraulic Oil Filter.....	H-5505
Hydraulic Oil Filter.....	HC-5505
Oil Filter Full Flow.....	C-5510
325L (EXCAVATORS) CAT 3116 (S/N: 2SL1-UP)	
Air Filter Primary.....	A-6006
Air Filter Secondary.....	A-6007
Air Filter Set.....	A-6118-S
Fuel Filter.....	F-5505
Fuel Filter.....	FC-5516
Fuel Filter Secondary.....	FC-55151
Fuel Filter Secondary.....	FC-5515
Fuel Filter.....	FC-5508
Hydraulic Oil Filter.....	HC-5505
Hydraulic Oil Filter.....	H-5505
Oil Filter Full Flow.....	C-5510
325L (EXCAVATORS) CAT 3116 (S/N: 3LL1-UP)	
Air Filter Set.....	A-6118-S
Air Filter Secondary.....	A-6007
Air Filter Primary.....	A-6006
Fuel Filter.....	F-5505
Fuel Filter.....	FC-5508

MODEL/APPLICATION	SAKURA NO	MODEL/APPLICATION	SAKURA NO	MODEL/APPLICATION	SAKURA NO
CATERPILLAR		CATERPILLAR		CATERPILLAR	
325L (EXCAVATORS) CAT 3116 (S/N: 9SG1-UP)		Hydraulic Oil Filter.....	H-5522	Hydraulic Oil Filter.....	H-5522
Hydraulic Oil Filter.....	H-5505	Hydraulic Oil Filter.....	HC-5801	Hydraulic Oil Filter.....	HC-55170
Oil Filter Full Flow.....	C-5510	Hydraulic Oil Filter.....	HC-55170	Hydraulic Oil Filter.....	HC-5801
325L (EXCAVATORS) CAT 3116 (S/N: 9ZK1-UP)		325D (EXCAVATORS) S/N: C4H210-UP		325D (EXCAVATORS) S/N: GPB1-UP	
Air Filter Primary.....	A-6006	Cabin Air Filter.....	CA-55850	Air Filter Primary.....	A-5558
Air Filter Set.....	A-6118-S	Hydraulic Oil Filter.....	HC-55170	Air Filter Secondary.....	A-5559
Air Filter Secondary.....	A-6007	Hydraulic Oil Filter.....	HC-5801	Cabin Air Filter.....	CA-55850
Fuel Filter.....	FC-5508	Hydraulic Oil Filter.....	H-5522	Hydraulic Oil Filter.....	HC-5801
Fuel Filter Secondary.....	FC-5515	325D (EXCAVATORS) S/N: C7K1-200-UP		Hydraulic Oil Filter.....	HC-55170
Fuel Filter Secondary.....	FC-55151	Air Filter Secondary.....	A-5559	Hydraulic Oil Filter.....	H-5522
Fuel Filter.....	FC-5516	Air Filter Primary.....	A-5558	325D (EXCAVATORS) S/N: JCL1-UP	
Fuel Filter.....	F-5505	Air Filter.....	A-5584	Air Filter Secondary.....	A-5559
Hydraulic Oil Filter.....	H-5505	Hydraulic Oil Filter.....	HC-5801	Air Filter Primary.....	A-5558
Hydraulic Oil Filter.....	HC-5505	Hydraulic Oil Filter.....	HC-55170	Cabin Air Filter.....	CA-55850
Oil Filter Full Flow.....	C-5510	Hydraulic Oil Filter.....	H-5522	Hydraulic Oil Filter.....	H-5522
325D (EXCAVATORS) CAT S/N: C7C1-UP		325D (EXCAVATORS) S/N: C8L1-166-UP		Hydraulic Oil Filter.....	HC-55170
Fuel Filter.....	FC-5517	Air Filter.....	A-5584	Hydraulic Oil Filter.....	HC-5801
Oil Filter Full Flow.....	C-5522	Air Filter Primary.....	A-5558	325D (EXCAVATORS) S/N: KBE1-UP	
325D (EXCAVATORS) CAT S/N: KHK1-UP		Air Filter Secondary.....	A-5559	Air Filter Primary.....	A-5558
Fuel Filter.....	FC-5517	Hydraulic Oil Filter.....	H-5522	Air Filter Secondary.....	A-5559
Oil Filter Full Flow.....	C-5522	Hydraulic Oil Filter.....	HC-55170	Cabin Air Filter.....	CA-55850
325D (EXCAVATORS) CAT C7 ACERT		Hydraulic Oil Filter.....	HC-5801	Hydraulic Oil Filter.....	HC-5801
Hydraulic Oil Filter.....	HC-9901	325D (EXCAVATORS) S/N: C8L167-UP		Hydraulic Oil Filter.....	HC-55170
325D (EXCAVATORS) S/N: A3R1-504-UP		Air Filter Secondary.....	A-5559	325D (EXCAVATORS) S/N: KDG1-UP	
Air Filter Secondary.....	A-5559	Air Filter Primary.....	A-5558	Air Filter Secondary.....	A-5559
Air Filter Primary.....	A-5558	Air Filter.....	A-5584	Air Filter Primary.....	A-5558
Cabin Air Filter.....	CA-55850	Hydraulic Oil Filter.....	HC-5801	Cabin Air Filter.....	CA-55850
Hydraulic Oil Filter.....	HC-55170	Hydraulic Oil Filter.....	H-5522	Hydraulic Oil Filter.....	H-5522
Hydraulic Oil Filter.....	HC-5801	325D (EXCAVATORS) S/N: C9M1-139-UP		Hydraulic Oil Filter.....	HC-55170
Hydraulic Oil Filter.....	H-5522	Air Filter Primary.....	A-5558	Hydraulic Oil Filter.....	HC-5801
325D (EXCAVATORS) S/N: A3R505-UP		Air Filter Secondary.....	A-5559	325D (EXCAVATORS) S/N: LWR1-UP	
Air Filter Primary.....	A-5558	Hydraulic Oil Filter.....	H-5522	Air Filter Primary.....	A-5558
Air Filter Secondary.....	A-5559	Hydraulic Oil Filter.....	HC-5801	Air Filter Secondary.....	A-5559
Cabin Air Filter.....	CA-55850	Hydraulic Oil Filter.....	HC-55170	Cabin Air Filter.....	CA-55850
Hydraulic Oil Filter.....	H-5522	325D (EXCAVATORS) S/N: C9M140-UP		Hydraulic Oil Filter.....	HC-5801
Hydraulic Oil Filter.....	HC-5801	Air Filter Secondary.....	A-5559	Hydraulic Oil Filter.....	HC-55170
Hydraulic Oil Filter.....	HC-55170	Air Filter Primary.....	A-5558	Hydraulic Oil Filter.....	H-5522
325D (EXCAVATORS) S/N: AZP1-UP		Hydraulic Oil Filter.....	HC-5801	325D (EXCAVATORS) S/N: MCL1-UP	
Air Filter Secondary.....	A-5559	Hydraulic Oil Filter.....	HC-55170	Air Filter Secondary.....	A-5559
Air Filter Primary.....	A-5558	325D (EXCAVATORS) S/N: DBH1-UP		Air Filter Primary.....	A-5558
Cabin Air Filter.....	CA-55850	Air Filter Primary.....	A-5558	Cabin Air Filter.....	CA-55850
Hydraulic Oil Filter.....	HC-55170	Air Filter Secondary.....	A-5559	Hydraulic Oil Filter.....	H-5522
Hydraulic Oil Filter.....	HC-5801	Cabin Air Filter.....	CA-55850	Hydraulic Oil Filter.....	HC-55170
Hydraulic Oil Filter.....	H-5522	Hydraulic Oil Filter.....	HC-5801	Hydraulic Oil Filter.....	HC-5801
325D (EXCAVATORS) S/N: C4H1-209-UP		Hydraulic Oil Filter.....	HC-55170	325D (EXCAVATORS) S/N: PAL1-UP	
Air Filter Primary.....	A-5558	Hydraulic Oil Filter.....	H-5522	Air Filter Primary.....	A-5558
Air Filter Secondary.....	A-5559	325D (EXCAVATORS) S/N: GBR1-UP		Air Filter Secondary.....	A-5559
Cabin Air Filter.....	CA-55850	Air Filter Secondary.....	A-5559	Cabin Air Filter.....	CA-55850
325D (EXCAVATORS) S/N: A3R505-UP		Air Filter Primary.....	A-5558	Hydraulic Oil Filter.....	HC-5801
Air Filter Primary.....	A-5558	Cabin Air Filter.....	CA-55850	Hydraulic Oil Filter.....	HC-55170
Air Filter Secondary.....	A-5559	Hydraulic Oil Filter.....	HC-55170	325D (EXCAVATORS) S/N: C4H1-209-UP	
Cabin Air Filter.....	CA-55850	Hydraulic Oil Filter.....	H-5522	Air Filter Primary.....	A-5558
325D (EXCAVATORS) S/N: A3R505-UP		325D (EXCAVATORS) S/N: C4H1-209-UP		Air Filter Secondary.....	A-5559
Air Filter Primary.....	A-5558	Air Filter Secondary.....	A-5559	Cabin Air Filter.....	CA-55850
Air Filter Secondary.....	A-5559	Air Filter Primary.....	A-5558	Hydraulic Oil Filter.....	HC-5801
Cabin Air Filter.....	CA-55850	Cabin Air Filter.....	CA-55850	Hydraulic Oil Filter.....	HC-55170

MODEL/APPLICATION	SAKURA NO	MODEL/APPLICATION	SAKURA NO	MODEL/APPLICATION	SAKURA NO
CATERPILLAR		CATERPILLAR		CATERPILLAR	
325D (EXCAVATORS) S/N: PAL1-UP		Fuel Filter.....	F-5505	Air Filter Primary.....	A-8508
Hydraulic Oil Filter.....	H-5522	Fuel Filter Secondary.....	FC-55151	Air Filter Set.....	A-8508M-S
325D (EXCAVATORS) S/N: PKE1-UP		Fuel Filter Secondary.....	FC-5515	Air Filter Set.....	A-8604-S
Air Filter Secondary.....	A-5559	Fuel Filter.....	FC-5516	Cabin Air Filter.....	CA-55850
Air Filter Primary.....	A-5558	Hydraulic Oil Filter.....	HC-5505	Fuel Filter Secondary.....	FC-55151
Cabin Air Filter.....	CA-55850	Hydraulic Oil Filter.....	H-5505	Fuel Filter.....	FC-5516
Hydraulic Oil Filter.....	H-5522	Oil Filter Full Flow.....	C-5510	Fuel Filter.....	FC-5508
Hydraulic Oil Filter.....	HC-55170	325 LN (EXCAVATORS) CAT 3116 (S/N: 3LL1-UP)		Hydraulic Oil Filter.....	HC-5505
Hydraulic Oil Filter.....	HC-5801	Air Filter Primary.....	A-6006	Hydraulic Oil Filter.....	HC-5801
325D (EXCAVATORS) S/N: RJK1-134-UP		Air Filter Set.....	A-6118-S	Oil Filter Full Flow.....	C-5510
Air Filter Primary.....	A-5558	Air Filter Secondary.....	A-6007	325B L JA (EXCAVATORS) CAT 3116 (S/N: 8RR1-UP)	
Air Filter Secondary.....	A-5559	Fuel Filter.....	F-5505	Air Filter Set.....	A-8604-S
Cabin Air Filter.....	CA-55850	Fuel Filter.....	FC-5516	Air Filter Set.....	A-8508M-S
Hydraulic Oil Filter.....	HC-5801	Fuel Filter Secondary.....	FC-5515	Air Filter Primary.....	A-8508
Hydraulic Oil Filter.....	HC-55170	Fuel Filter Secondary.....	FC-55151	Air Filter Primary.....	A-8508M
Hydraulic Oil Filter.....	H-5522	Hydraulic Oil Filter.....	H-5505	Air Filter Secondary.....	A-8507
325D (EXCAVATORS) S/N: RJK135-UP		Hydraulic Oil Filter.....	HC-5505	Cabin Air Filter.....	CA-55850
Cabin Air Filter.....	CA-55850	Oil Filter Full Flow.....	C-5510	Fuel Filter.....	FC-5508
Hydraulic Oil Filter.....	H-5522	325 LN (EXCAVATORS) CAT 3116 (S/N: 7LJ1-UP)		Fuel Filter.....	FC-5516
Hydraulic Oil Filter.....	HC-55170	Air Filter Secondary.....	A-6007	Fuel Filter Secondary.....	FC-5515
Hydraulic Oil Filter.....	HC-5801	Air Filter Set.....	A-6118-S	Fuel Filter Secondary.....	FC-55151
325D (EXCAVATORS) S/N: SCR1-UP		Air Filter Primary.....	A-6006	Hydraulic Oil Filter.....	HC-5801
Air Filter Secondary.....	A-5559	Fuel Filter Secondary.....	FC-55151	Hydraulic Oil Filter.....	HC-5505
Air Filter Primary.....	A-5558	Fuel Filter Secondary.....	FC-5515	Oil Filter Full Flow.....	C-5510
Cabin Air Filter.....	CA-55850	Fuel Filter.....	F-5505	325B L US (EXCAVATORS) CAT 3116 (S/N: 2JR1-UP)	
Hydraulic Oil Filter.....	HC-5801	Hydraulic Oil Filter.....	HC-5505	Air Filter Set.....	A-8604-S
Hydraulic Oil Filter.....	HC-55170	Hydraulic Oil Filter.....	H-5505	Air Filter Set.....	A-8508M-S
Hydraulic Oil Filter.....	H-5522	Oil Filter Full Flow.....	C-5510	Air Filter Primary.....	A-8508
325D (EXCAVATORS) S/N: T2S1-UP		325 LN (EXCAVATORS) CAT 3116 (S/N: 9SG1-UP)		Air Filter Primary.....	A-8508M
Air Filter Primary.....	A-5558	Air Filter Primary.....	A-6006	Air Filter Secondary.....	A-8507
Air Filter Secondary.....	A-5559	Air Filter Set.....	A-6118-S	Cabin Air Filter.....	CA-55850
Cabin Air Filter.....	CA-55850	Air Filter Secondary.....	A-6007	Fuel Filter.....	FC-5508
Hydraulic Oil Filter.....	H-5522	Fuel Filter.....	F-5505	Fuel Filter.....	FC-5516
Hydraulic Oil Filter.....	HC-55170	Fuel Filter Secondary.....	FC-55151	Fuel Filter Secondary.....	FC-5515
Hydraulic Oil Filter.....	HC-5801	Fuel Filter.....	FC-5516	Fuel Filter Secondary.....	FC-55151
325 LN (EXCAVATORS) CAT 3116 (S/N: 2SK1-UP)		Fuel Filter Secondary.....	FC-5515	Hydraulic Oil Filter.....	HC-5801
Air Filter Primary.....	A-6006	Hydraulic Oil Filter.....	H-5505	Hydraulic Oil Filter.....	HC-5505
Air Filter Set.....	A-6118-S	Oil Filter Full Flow.....	C-5510	Hydraulic Oil Filter.....	H-7942
Air Filter Secondary.....	A-6007	325 LN (EXCAVATORS) CAT 3116 (S/N: 9ZK1-UP)		Oil Filter Full Flow.....	C-5510
Fuel Filter.....	F-5505	Air Filter Secondary.....	A-6007	325B LN (EXCAVATORS) CAT 3116 (S/N: 4DS1-UP)	
Fuel Filter.....	FC-5516	Air Filter Set.....	A-6118-S	Air Filter Set.....	A-5549M-S
Fuel Filter Secondary.....	FC-5515	Air Filter Primary.....	A-6006	Air Filter Secondary.....	A-5550
Fuel Filter Secondary.....	FC-55151	Fuel Filter Secondary.....	FC-55151	Air Filter Primary.....	A-5549M
Hydraulic Oil Filter.....	H-5505	Fuel Filter.....	F-5505	Air Filter Secondary.....	A-8507
Hydraulic Oil Filter.....	HC-5505	Fuel Filter Secondary.....	FC-5515	Air Filter Primary.....	A-8508M
Oil Filter Full Flow.....	C-5510	Fuel Filter.....	FC-5516	Air Filter Primary.....	A-8508
325 LN (EXCAVATORS) CAT 3116 (S/N: 2SL1-UP)		Hydraulic Oil Filter.....	HC-5505	Air Filter Set.....	A-8508M-S
Air Filter Secondary.....	A-6007	Hydraulic Oil Filter.....	H-5505	Air Filter Set.....	A-8604-S
Air Filter Set.....	A-6118-S	Oil Filter Full Flow.....	C-5510	Fuel Filter Secondary.....	FC-55151
Air Filter Primary.....	A-6006	325B L JA (EXCAVATORS) CAT 3116 (S/N: 8PR1-UP)		Fuel Filter Secondary.....	FC-5515
Fuel Filter Secondary.....	FC-55151	Air Filter Secondary.....	A-8507	Fuel Filter.....	FC-5516
Fuel Filter.....	F-5505	Air Filter Primary.....	A-8508M	Fuel Filter.....	FC-5508
Fuel Filter Secondary.....	FC-5515	325B L US (EXCAVATORS) CAT 3116 (S/N: 2JR1-UP)		Hydraulic Oil Filter.....	H-7942
Hydraulic Oil Filter.....	HC-5505	Air Filter Set.....	A-8604-S	Hydraulic Oil Filter.....	HC-5801
Hydraulic Oil Filter.....	H-5505	Air Filter Secondary.....	A-8507		
Oil Filter Full Flow.....	C-5510	Air Filter Primary.....	A-8508M		
325 LN (EXCAVATORS) CAT 3116 (S/N: 2SL1-UP)		Air Filter Secondary.....	A-8507		
Air Filter Secondary.....	A-6007	Air Filter Primary.....	A-8508M		
Air Filter Set.....	A-6118-S	Air Filter Set.....	A-8508M-S		
Air Filter Primary.....	A-6006	Air Filter Set.....	A-8604-S		
Fuel Filter Secondary.....	FC-55151	Fuel Filter Secondary.....	FC-55151		
Fuel Filter.....	F-5505	Fuel Filter.....	FC-5516		
Fuel Filter Secondary.....	FC-5515	Fuel Filter Secondary.....	FC-5515		
Hydraulic Oil Filter.....	H-5505	Hydraulic Oil Filter.....	HC-5801		
Hydraulic Oil Filter.....	HC-5505	Hydraulic Oil Filter.....	HC-5505		
Oil Filter Full Flow.....	C-5510	Hydraulic Oil Filter.....	H-7942		
325 LN (EXCAVATORS) CAT 3116 (S/N: 2SL1-UP)		Oil Filter Full Flow.....	C-5510		
Air Filter Secondary.....	A-6007	325B L JA (EXCAVATORS) CAT 3116 (S/N: 8PR1-UP)			
Air Filter Set.....	A-6118-S	Air Filter Secondary.....	A-8507		
Air Filter Primary.....	A-6006	Air Filter Primary.....	A-8508M		
Fuel Filter Secondary.....	FC-55151				
Fuel Filter.....	F-5505				
Fuel Filter Secondary.....	FC-5515				
Hydraulic Oil Filter.....	H-5505				
Hydraulic Oil Filter.....	HC-5505				
Oil Filter Full Flow.....	C-5510				

Sakura Filter

ENGINE APPLICATION

MODEL/APPLICATION	SAKURA NO	MODEL/APPLICATION	SAKURA NO	MODEL/APPLICATION	SAKURA NO
CATERPILLAR		CATERPILLAR		CATERPILLAR	
325B LN (EXCAVATORS) CAT 3116 (S/N: 4DS1-UP)		325C FP (EXCAVATORS) CAT 3116		328d (EXCAVATORS) CAT S/N: GTN1-UP	
Hydraulic Oil Filter.....	HC-5505	Hydraulic Oil Filter.....	H-7942	Cabin Air Filter.....	CA-55850
Oil Filter Full Flow.....	C-5510	Oil Filter Full Flow.....	C-5510	Fuel Filter.....	FC-5517
325B LN (EXCAVATORS) CAT 3116 (S/N: SBS1-UP)		325C FP (EXCAVATORS) CAT 3116 (S/N: G1L1-UP)		328d (EXCAVATORS) CAT S/N: KHX1-UP	
Air Filter Set.....	A-8604-S	Hydraulic Oil Filter.....	HC-9901	Air Filter Primary.....	A-5558
Air Filter Set.....	A-8508M-S	325C FP (EXCAVATORS) CAT 3116 (S/N: M2K1-UP)		Air Filter Secondary.....	A-5559
Air Filter Primary.....	A-8508	Air Filter Primary.....	A-5558	Air Filter Secondary.....	A-5559
Air Filter Primary.....	A-8508M	Air Filter Secondary.....	A-5559	Fuel Filter.....	FC-5517
Air Filter Secondary.....	A-8507	Cabin Air Filter.....	CA-55850	Hydraulic Oil Filter.....	H-5522
Air Filter Secondary.....	A-8507M	Fuel Filter.....	FC-5517	Hydraulic Oil Filter.....	HC-5801
Air Filter Primary.....	A-5549M	Hydraulic Oil Filter.....	HC-5801	Hydraulic Oil Filter.....	HC-55170
Air Filter Primary.....	A-5549	Hydraulic Oil Filter.....	H-7942	Hydraulic Oil Filter.....	HC-55170
Air Filter Secondary.....	A-5550	Hydraulic Oil Filter.....	H-7942	Oil Filter Full Flow.....	C-5522
Air Filter Set.....	A-5549M-S	Oil Filter Full Flow.....	C-5510	328d (EXCAVATORS) CAT S/N: MKR1-UP	
Fuel Filter.....	FC-5508	325C FP (EXCAVATORS) CAT 3116 (S/N: S3M1-UP)		Air Filter Secondary.....	A-5559
Fuel Filter.....	FC-5516	Air Filter Secondary.....	A-5558	Air Filter Primary.....	A-5558
Fuel Filter Secondary.....	FC-5515	Air Filter Primary.....	A-5559	Fuel Filter.....	FC-5517
Fuel Filter Secondary.....	FC-55151	Cabin Air Filter.....	CA-55850	Hydraulic Oil Filter.....	H-5522
Hydraulic Oil Filter.....	HC-5505	Fuel Filter.....	FC-5517	Hydraulic Oil Filter.....	HC-5801
Hydraulic Oil Filter.....	HC-5801	Hydraulic Oil Filter.....	HC-5801	Hydraulic Oil Filter.....	HC-55170
Hydraulic Oil Filter.....	H-7942	Hydraulic Oil Filter.....	H-7942	Hydraulic Oil Filter.....	HC-5801
Oil Filter Full Flow.....	C-5510	Hydraulic Oil Filter.....	HC-55170	Oil Filter Full Flow.....	C-5522
325B LN (EXCAVATORS) CAT 3116 (S/N: 6DN1-UP)		Oil Filter Full Flow.....	C-5510	328d (EXCAVATORS) CAT C7 ACERT	
Air Filter Set.....	A-5549M-S	325C FP (EXCAVATORS) CAT 3116 (S/N: Y4P1-UP)		Hydraulic Oil Filter.....	HC-9901
Air Filter Secondary.....	A-5550	Air Filter Secondary.....	A-5559	329E L (EXCAVATORS) CAT C7.1 ACERT	
Air Filter Primary.....	A-5549	Air Filter Primary.....	A-5558	Hydraulic Oil Filter.....	HC-9901
Air Filter Primary.....	A-5549M	Cabin Air Filter.....	CA-55850	329E L (EXCAVATORS)	
Air Filter Secondary.....	A-8507	Fuel Filter.....	FC-5517	Fuel Filter.....	EF-55030
Air Filter Secondary.....	A-8507M	Hydraulic Oil Filter.....	H-7942	330 (EXCAVATORS) CAT 3116 (S/N: 6ZK1-UP)	
Air Filter Primary.....	A-8508M	Hydraulic Oil Filter.....	HC-55170	Air Filter Primary.....	A-28710
Air Filter Primary.....	A-8508	Hydraulic Oil Filter.....	HC-55170	Air Filter Set.....	A-28730-S
Air Filter Set.....	A-8508M-S	Hydraulic Oil Filter.....	H-7942	Air Filter Secondary.....	A-7967
Air Filter Set.....	A-8604-S	Hydraulic Oil Filter.....	H-7942	Fuel Filter Secondary.....	FC-5507
Fuel Filter Secondary.....	FC-55151	Hydraulic Oil Filter.....	H-7942	Fuel Filter.....	F-5505
Fuel Filter.....	FC-5515	Hydraulic Oil Filter.....	HC-55170	Hydraulic Oil Filter.....	H-5505
Fuel Filter.....	FC-5516	Hydraulic Oil Filter.....	HC-5801	Hydraulic Oil Filter.....	HC-5505
Fuel Filter.....	FC-5508	Oil Filter Full Flow.....	C-5510	Oil Filter Full Flow.....	C-5510
Hydraulic Oil Filter.....	H-7942	325C MH (MATERIAL HANDLERS) CAT 3116 (S/N: DTF1-UP)		330 (EXCAVATORS) CAT 3304B (S/N: 6WJ1-UP)	
Hydraulic Oil Filter.....	HC-5801	Air Filter Secondary.....	A-5559	Air Filter Primary.....	A-28710
Hydraulic Oil Filter.....	HC-5505	Air Filter Primary.....	A-5558	Air Filter Secondary.....	A-7967
Oil Filter Full Flow.....	C-5510	Cabin Air Filter.....	CA-55850	Air Filter Set.....	A-28730-S
325B LN (EXCAVATORS) CAT 3116 (S/N: 8FN1-UP)		Fuel Filter.....	FC-5517	Cabin Air Filter.....	CA-55850
Air Filter Set.....	A-8604-S	Hydraulic Oil Filter.....	H-7942		
Air Filter Set.....	A-8508M-S	Hydraulic Oil Filter.....	HC-55170		
Air Filter Primary.....	A-8508	Hydraulic Oil Filter.....	HC-5801		
Air Filter Primary.....	A-8508M	Oil Filter Full Flow.....	C-5510		
Air Filter Secondary.....	A-8507	325C MH (MATERIAL HANDLERS) CAT 3116 (S/N: S2C1-UP)			
Air Filter Secondary.....	A-8507M	Air Filter Secondary.....	A-5559		
Air Filter Primary.....	A-5549M	Air Filter Primary.....	A-5558		
Air Filter Primary.....	A-5549	Cabin Air Filter.....	CA-55850		
Air Filter Secondary.....	A-5550	Fuel Filter.....	FC-5517		
Air Filter Set.....	A-5549M-S	Hydraulic Oil Filter.....	H-5522		
Fuel Filter Secondary.....	FC-55151	Hydraulic Oil Filter.....	HC-5801		
Fuel Filter.....	FC-5508	Oil Filter Full Flow.....	C-5510		
Fuel Filter.....	FC-5516	325C MH (MATERIAL HANDLERS) CAT 3116 (S/N: S2C1-UP)			
Fuel Filter Secondary.....	FC-5515	Air Filter Primary.....	A-5558		
Hydraulic Oil Filter.....	HC-5505	Air Filter Secondary.....	A-5559		
Hydraulic Oil Filter.....	HC-5801				

MODEL/APPLICATION	SAKURA NO
CATERPILLAR	
330 L (EXCAVATORS) CAT 3306 (S/N: 8FK1-UP)	
Air Filter Primary.....	A-28710
Air Filter Set.....	A-28730-S
Air Filter Secondary.....	A-7967
Air Filter Primary.....	A-5509
Air Filter Set.....	A-5522-S
Fuel/Water Separator.....	SF-5704
Oil Filter Full Flow.....	C-5510
330 L (EXCAVATORS) CAT 3306 (S/N: 8RL1-UP)	
Air Filter Set.....	A-28730-S
Air Filter Primary.....	A-28710
Air Filter Secondary.....	A-7967
Fuel Filter Secondary.....	FC-5507
Fuel Filter.....	F-5505
Hydraulic Oil Filter.....	HC-5505
Hydraulic Oil Filter.....	H-5505
Oil Filter Full Flow.....	C-5510
330 L (EXCAVATORS) CAT 3306 (S/N: 9ML1-UP)	
Air Filter Secondary.....	A-7967
Air Filter Primary.....	A-28710
Air Filter Set.....	A-28730-S
Fuel Filter.....	F-5505
Fuel Filter Secondary.....	FC-5507
Hydraulic Oil Filter.....	H-5505
Hydraulic Oil Filter.....	HC-5505
Oil Filter Full Flow.....	C-5510
330 L (EXCAVATORS) CAT 3306 (S/N: 9NG1-UP)	
Air Filter Set.....	A-28730-S
Air Filter Primary.....	A-28710
Air Filter Secondary.....	A-7967
Fuel Filter Secondary.....	FC-5507
Fuel Filter.....	F-5505
Hydraulic Oil Filter.....	HC-5505
Hydraulic Oil Filter.....	H-5505
Oil Filter Full Flow.....	C-5510
330 L (EXCAVATORS) CAT 3306 (S/N: 9PJ1-UP)	
Air Filter Primary.....	A-28710
Air Filter Set.....	A-28730-S
Air Filter Secondary.....	A-7967
Fuel Filter.....	F-5505
Fuel Filter Secondary.....	FC-5507
Hydraulic Oil Filter.....	H-5505
Hydraulic Oil Filter.....	HC-5505
Oil Filter Full Flow.....	C-5510
330 L (EXCAVATORS) CAT 3306 (S/N: 9WJ1-UP)	
Air Filter Set.....	A-28730-S
Air Filter Primary.....	A-28710
Air Filter Secondary.....	A-7967
Fuel Filter Secondary.....	FC-5507
Fuel Filter.....	F-5505
Hydraulic Oil Filter.....	HC-5505
Hydraulic Oil Filter.....	H-5505

MODEL/APPLICATION	SAKURA NO
CATERPILLAR	
Oil Filter Full Flow.....	C-5510
330 L (EXCAVATORS) S/N: 2EL1-UP	
Air Filter Secondary.....	A-6007
Air Filter Primary.....	A-28710
Air Filter Set.....	A-28730-S
Fuel Filter Secondary.....	FC-5507
Hydraulic Oil Filter.....	H-5505
Oil Filter Full Flow.....	C-5510
330B (EXCAVATORS) CAT 3306 (S/N: 4RS1-UP)	
Air Filter Secondary.....	A-5559
Air Filter Primary.....	A-5558
Fuel Filter.....	F-5505
Fuel Filter Secondary.....	FC-5507
Hydraulic Oil Filter.....	HC-5801
Hydraulic Oil Filter.....	HC-5505
Hydraulic Oil Filter.....	H-7942
Oil Filter Full Flow.....	C-5510
330B (EXCAVATORS) CAT 3306 (S/N: 5LS1-UP)	
Air Filter Primary.....	A-5558
Air Filter Secondary.....	A-5559
Fuel Filter Secondary.....	FC-5507
Fuel Filter.....	F-5505
Hydraulic Oil Filter.....	H-7942
Hydraulic Oil Filter.....	HC-5505
Hydraulic Oil Filter.....	HC-5801
Oil Filter Full Flow.....	C-5510
330B (EXCAVATORS) CAT 3306 (S/N: 8SR1-UP)	
Air Filter Secondary.....	A-5559
Air Filter Primary.....	A-5558
Fuel Filter.....	F-5505
Fuel Filter Secondary.....	FC-5507
Hydraulic Oil Filter.....	H-7942
Hydraulic Oil Filter.....	HC-5801
Hydraulic Oil Filter.....	HC-5505
Oil Filter Full Flow.....	C-5510
330B (EXCAVATORS) CAT 3306 (S/N: 8TR1-UP)	
Air Filter Primary.....	A-5558
Air Filter Secondary.....	A-5559
Fuel Filter Secondary.....	FC-5507
Fuel Filter.....	F-5505
Hydraulic Oil Filter.....	HC-5505
Hydraulic Oil Filter.....	HC-5801
Hydraulic Oil Filter.....	H-7942
Oil Filter Full Flow.....	C-5510
330B (EXCAVATORS) S/N: 4RS396-UP	
Air Filter Secondary.....	A-5559
Air Filter Primary.....	A-5558
Cabin Air Filter.....	CA-55850
Fuel Filter.....	F-5505
Fuel Filter Secondary.....	FC-5507
Hydraulic Oil Filter.....	H-7942
Hydraulic Oil Filter.....	HC-5801
Hydraulic Oil Filter.....	HC-5505

MODEL/APPLICATION	SAKURA NO
CATERPILLAR	
Oil Filter Full Flow.....	C-5510
330B (EXCAVATORS) S/N: 9HN1-UP	
Fuel Filter Secondary.....	FC-5507
330C L (EXCAVATORS) CAT C9 (S/N: CAP1-903-UP)	
Air Filter Secondary.....	A-8651
Cabin Air Filter.....	CA-55850
Fuel Filter.....	FC-5517
Fuel/Water Separator Secondary..	SFC-5504-10
Fuel/Water Separator Secondary..	SFC-5504-10B
Hydraulic Oil Filter.....	H-5522
Hydraulic Oil Filter.....	HC-5801
330C L (EXCAVATORS) CAT C9 (S/N: CAP1-UP)	
Air Filter Secondary.....	A-8651
Cabin Air Filter.....	CA-55850
Fuel Filter.....	FC-5517
Fuel/Water Separator Secondary..	SFC-5504-10B
Fuel/Water Separator Secondary..	SFC-5504-10
Hydraulic Oil Filter.....	HC-5801
Hydraulic Oil Filter.....	H-5522
330C L (EXCAVATORS) CAT C9 (S/N: CAP226-UP)	
Air Filter Secondary.....	A-8651
Cabin Air Filter.....	CA-55850
Fuel Filter.....	FC-5517
Fuel/Water Separator Secondary..	SFC-5504-10
Fuel/Water Separator Secondary..	SFC-5504-10B
Hydraulic Oil Filter.....	H-5522
Hydraulic Oil Filter.....	HC-5801
330C L (EXCAVATORS) CAT C9 (S/N: CAP904-UP)	
Air Filter Secondary.....	A-8651
Cabin Air Filter.....	CA-55850
Fuel Filter.....	FC-5517
Fuel/Water Separator Secondary..	SFC-5504-10B
Fuel/Water Separator Secondary..	SFC-5504-10
Hydraulic Oil Filter.....	HC-5801
Hydraulic Oil Filter.....	H-5522
330C L (EXCAVATORS) CAT C9 (S/N: CGZ1-UP)	
Air Filter Secondary.....	A-8651
Fuel Filter.....	FC-5517
Hydraulic Oil Filter.....	H-7942
Hydraulic Oil Filter.....	HC-5801
Oil Filter Full Flow.....	C-5516
330C L (EXCAVATORS) CAT C9 (S/N: CYA1-UP)	
Air Filter Secondary.....	A-8651
Cabin Air Filter.....	CA-55850
Fuel Filter.....	FC-5517
Hydraulic Oil Filter.....	HC-5801
Hydraulic Oil Filter.....	H-7942
330C L (EXCAVATORS) CAT C9 (S/N: DKY1-1243-UP)	
Air Filter Secondary.....	A-8651

MODEL/APPLICATION	SAKURA NO	MODEL/APPLICATION	SAKURA NO	MODEL/APPLICATION	SAKURA NO
CATERPILLAR		CATERPILLAR		CATERPILLAR	
330C L (EXCAVATORS) CAT C9 (S/N: DKY1-1243-UP) Cabin Air Filter..... CA-55850 Fuel Filter..... FC-5517 Fuel/Water Separator Secondary.. SFC-5504-10 Fuel/Water Separator Secondary.. SFC-5504-10B Hydraulic Oil Filter..... H-5522 Hydraulic Oil Filter..... HC-5801		Hydraulic Oil Filter..... HC-5801 330C (EXCAVATORS) CAT C9 Hydraulic Oil Filter..... HC-9901 330C (EXCAVATORS) CAT C9 (S/N: DKY1-UP) Air Filter Secondary..... A-8651 Cabin Air Filter..... CA-55850 Fuel Filter..... FC-5517 Hydraulic Oil Filter..... H-7942 Hydraulic Oil Filter..... HC-55170 Hydraulic Oil Filter..... HC-5801		330C FP (EXCAVATORS) CAT 3304B (S/N: B1K1-UP) Air Filter Secondary..... A-8651 Cabin Air Filter..... CA-55850 Fuel Filter..... FC-5517 Hydraulic Oil Filter..... HC-5801 Hydraulic Oil Filter..... H-7942 Hydraulic Oil Filter..... HC-55170	
330C L (EXCAVATORS) CAT C9 (S/N: DKY1243-UP) Air Filter Secondary..... A-8651 Cabin Air Filter..... CA-55850 Fuel Filter..... FC-5517 Fuel/Water Separator Secondary.. SFC-5504-10B Fuel/Water Separator Secondary.. SFC-5504-10 Hydraulic Oil Filter..... HC-5801 Hydraulic Oil Filter..... H-5522		330C (EXCAVATORS) CAT C9 (S/N: GKX1-UP) Air Filter Secondary..... A-8651 Cabin Air Filter..... CA-55850 Hydraulic Oil Filter..... H-7942 Hydraulic Oil Filter..... HC-5801 Hydraulic Oil Filter..... HC-55170		330C FP (EXCAVATORS) CAT 3304B (S/N: B2L1-UP) Air Filter Secondary..... A-8651 Fuel Filter..... FC-5517 Hydraulic Oil Filter..... HC-5801 Hydraulic Oil Filter..... H-7942 Hydraulic Oil Filter..... HC-55170	
330C L (EXCAVATORS) CAT C9 (S/N: DKY1-UP) Air Filter Secondary..... A-8651 Cabin Air Filter..... CA-55850 Fuel Filter..... FC-5517 Hydraulic Oil Filter..... H-7942 Hydraulic Oil Filter..... HC-5801 Hydraulic Oil Filter..... HC-55170		330C (EXCAVATORS) CAT C9 (S/N: JCD1-UP) Air Filter Secondary..... A-8651 Cabin Air Filter..... CA-55850 Fuel Filter..... FC-5517 Hydraulic Oil Filter..... HC-5801 Hydraulic Oil Filter..... H-5522 Hydraulic Oil Filter..... H-7942		330C FP (EXCAVATORS) CAT 3304B (S/N: B3M1-UP) Air Filter Secondary..... A-8651 Cabin Air Filter..... CA-55850 Fuel Filter..... FC-5517 Hydraulic Oil Filter..... H-7942 Hydraulic Oil Filter..... HC-55170 Hydraulic Oil Filter..... HC-5801	
330C L (EXCAVATORS) CAT C9 (S/N: GKX1-UP) Air Filter Secondary..... A-8651 Cabin Air Filter..... CA-55850 Fuel Filter..... FC-5517 Hydraulic Oil Filter..... HC-55170 Hydraulic Oil Filter..... HC-5801 Hydraulic Oil Filter..... H-7942		330C (EXCAVATORS) CAT C9 (S/N: JNK1-UP) Air Filter Secondary..... A-8651 Cabin Air Filter..... CA-55850 Fuel Filter..... FC-5517 Fuel/Water Separator Secondary.. SFC-5504-10B Fuel/Water Separator Secondary.. SFC-5504-10 Hydraulic Oil Filter..... H-7942 Hydraulic Oil Filter..... H-5522 Hydraulic Oil Filter..... HC-5801		330C FP (EXCAVATORS) CAT 3304B (S/N: B4N1-UP) Air Filter Secondary..... A-8651 Cabin Air Filter..... CA-55850 Fuel Filter..... FC-5517 Hydraulic Oil Filter..... HC-5801 Hydraulic Oil Filter..... HC-55170 Hydraulic Oil Filter..... H-7942	
330C L (EXCAVATORS) CAT C9 (S/N: JAB1-UP) Air Filter Secondary..... A-8651 Cabin Air Filter..... CA-55850 Fuel Filter..... FC-5517 Hydraulic Oil Filter..... H-7942 Hydraulic Oil Filter..... HC-5801		330C (EXCAVATORS) CAT C9 (S/N: MCA1-UP) Air Filter Secondary..... A-8651 Cabin Air Filter..... CA-55850 Fuel Filter..... FC-5517 Hydraulic Oil Filter..... HC-5801 Hydraulic Oil Filter..... HC-55170 Hydraulic Oil Filter..... H-7942		330C MH (MATERIAL HANDLERS) CAT 3304B (S/N: MKM1-UP) Air Filter Secondary..... A-8651 Cabin Air Filter..... CA-55850 Fuel Filter..... FC-5517 Hydraulic Oil Filter..... H-5522 Hydraulic Oil Filter..... HC-5801	
330C L (EXCAVATORS) CAT C9 (S/N: KDD1-UP) Air Filter Secondary..... A-8651 Cabin Air Filter..... CA-55850 Fuel Filter..... FC-5517 Hydraulic Oil Filter..... HC-5801 Hydraulic Oil Filter..... H-7942		330C (EXCAVATORS) CAT C9 (S/N: MKM1-UP) Air Filter Secondary..... A-8651 Cabin Air Filter..... CA-55850 Fuel Filter..... FC-5517 Hydraulic Oil Filter..... HC-5801 Hydraulic Oil Filter..... HC-55170 Hydraulic Oil Filter..... H-7942		330CLME (EXCAVATORS) 2004-UP Air Filter Secondary..... A-8651 Cabin Air Filter..... CA-55850 Fuel Filter..... FC-5517 Hydraulic Oil Filter..... HC-5801 Hydraulic Oil Filter..... H-7942	
330C LN (EXCAVATORS) CAT C9 (S/N: CGZ1-UP) Air Filter Secondary..... A-8651 Fuel Filter..... FC-5517 Hydraulic Oil Filter..... HC-5801 Hydraulic Oil Filter..... H-7942		330C (EXCAVATORS) CAT C9 (S/N: MKM1-UP) Air Filter Secondary..... A-8651 Cabin Air Filter..... CA-55850 Fuel Filter..... FC-5517 Fuel/Water Separator Secondary.. SFC-5504-10 Fuel/Water Separator Secondary.. SFC-5504-10B Hydraulic Oil Filter..... H-5522 Hydraulic Oil Filter..... HC-5801		330D (EXCAVATORS) CAT S/N: THX1-UP Fuel Filter..... FC-5517	
330C (EXCAVATORS) CAT C9 (S/N: CYA1-UP) , 2002-UP Air Filter Secondary..... A-8651 Cabin Air Filter..... CA-55850 Hydraulic Oil Filter..... H-7942		330C FP (EXCAVATORS) CAT 3304B Hydraulic Oil Filter..... HC-9901		330D (EXCAVATORS) CAT S/N: THY1-UP Fuel Filter..... FC-5517	
				330D (EXCAVATORS) CAT C9 ACERT Hydraulic Oil Filter..... HC-9901	
				330D (EXCAVATORS) S/N: B6H1-UP Air Filter Secondary..... A-8651	

MODEL/APPLICATION	SAKURA NO
CATERPILLAR	
330D (EXCAVATORS) S/N: B6H1-UP	
Cabin Air Filter.....	CA-55850
Hydraulic Oil Filter.....	HC-5801
Hydraulic Oil Filter.....	H-5522
Hydraulic Oil Filter.....	HC-55170
330D (EXCAVATORS) S/N: C5K1-222-UP	
Air Filter Secondary.....	A-8651
Cabin Air Filter.....	CA-55850
Hydraulic Oil Filter.....	HC-55170
Hydraulic Oil Filter.....	H-5522
Hydraulic Oil Filter.....	HC-5801
330D (EXCAVATORS) S/N: C5K223-UP	
Air Filter Secondary.....	A-8651
Cabin Air Filter.....	CA-55850
Hydraulic Oil Filter.....	HC-5801
Hydraulic Oil Filter.....	H-5522
Hydraulic Oil Filter.....	HC-55170
330D (EXCAVATORS) S/N: E4K1-349-UP	
Air Filter Secondary.....	A-8651
Hydraulic Oil Filter.....	HC-55170
Hydraulic Oil Filter.....	H-5522
Hydraulic Oil Filter.....	HC-5801
330D (EXCAVATORS) S/N: EAH1-UP	
Air Filter Secondary.....	A-8651
Cabin Air Filter.....	CA-55850
Hydraulic Oil Filter.....	HC-5801
Hydraulic Oil Filter.....	H-5522
Hydraulic Oil Filter.....	HC-55170
330D (EXCAVATORS) S/N: EAK350-UP	
Air Filter Secondary.....	A-8651
Hydraulic Oil Filter.....	HC-55170
Hydraulic Oil Filter.....	H-5522
Hydraulic Oil Filter.....	HC-5801
330D (EXCAVATORS) S/N: EDX1-UP	
Air Filter Secondary.....	A-8651
Cabin Air Filter.....	CA-55850
Hydraulic Oil Filter.....	HC-5801
Hydraulic Oil Filter.....	H-5522
Hydraulic Oil Filter.....	HC-55170
330D (EXCAVATORS) S/N: ERN1-UP	
Air Filter Secondary.....	A-8651
Cabin Air Filter.....	CA-55850
Hydraulic Oil Filter.....	HC-55170
Hydraulic Oil Filter.....	H-5522
Hydraulic Oil Filter.....	HC-5801
330D (EXCAVATORS) S/N: FFK1-UP	
Air Filter Secondary.....	A-8651
Cabin Air Filter.....	CA-55850

MODEL/APPLICATION	SAKURA NO
CATERPILLAR	
Hydraulic Oil Filter.....	HC-5801
Hydraulic Oil Filter.....	H-5522
Hydraulic Oil Filter.....	HC-55170
330D (EXCAVATORS) S/N: GGE1-UP	
Air Filter Secondary.....	A-8651
Cabin Air Filter.....	CA-55850
Hydraulic Oil Filter.....	HC-55170
Hydraulic Oil Filter.....	H-5522
Hydraulic Oil Filter.....	HC-5801
330D (EXCAVATORS) S/N: H3K1-UP	
Air Filter.....	A-5584
Air Filter Secondary.....	A-8651
Hydraulic Oil Filter.....	HC-5801
Hydraulic Oil Filter.....	H-5522
Hydraulic Oil Filter.....	HC-55170
330D (EXCAVATORS) S/N: HAS1-UP	
Air Filter Secondary.....	A-8651
Cabin Air Filter.....	CA-55850
Hydraulic Oil Filter.....	HC-5801
Hydraulic Oil Filter.....	HC-55170
Hydraulic Oil Filter.....	H-5522
330D (EXCAVATORS) S/N: JLP1-UP	
Air Filter Secondary.....	A-8651
Cabin Air Filter.....	CA-55850
Hydraulic Oil Filter.....	H-5522
Hydraulic Oil Filter.....	HC-55170
Hydraulic Oil Filter.....	HC-5801
330D (EXCAVATORS) S/N: L2K1-UP	
Air Filter.....	A-5584
Air Filter Secondary.....	A-8651
Hydraulic Oil Filter.....	HC-55170
Hydraulic Oil Filter.....	H-5522
Hydraulic Oil Filter.....	HC-5801
330D (EXCAVATORS) S/N: LEM1-190-UP	
Air Filter Secondary.....	A-8651
Cabin Air Filter.....	CA-55850
Hydraulic Oil Filter.....	HC-5801
Hydraulic Oil Filter.....	H-5522
Hydraulic Oil Filter.....	HC-55170
330D (EXCAVATORS) S/N: LEM191-UP	
Air Filter Secondary.....	A-8651
Cabin Air Filter.....	CA-55850
Hydraulic Oil Filter.....	HC-55170
Hydraulic Oil Filter.....	H-5522
Hydraulic Oil Filter.....	HC-5801
330D (EXCAVATORS) S/N: MAG1-UP	
Air Filter Secondary.....	A-8651
Cabin Air Filter.....	CA-55850
Hydraulic Oil Filter.....	HC-5801
Hydraulic Oil Filter.....	H-5522

MODEL/APPLICATION	SAKURA NO
CATERPILLAR	
Hydraulic Oil Filter.....	HC-55170
330D (EXCAVATORS) S/N: MEY1-UP	
Air Filter Secondary.....	A-8651
Cabin Air Filter.....	CA-55850
Hydraulic Oil Filter.....	HC-55170
Hydraulic Oil Filter.....	H-5522
Hydraulic Oil Filter.....	HC-5801
330D (EXCAVATORS) S/N: MWP1-UP	
Air Filter Secondary.....	A-8651
Cabin Air Filter.....	CA-55850
Hydraulic Oil Filter.....	HC-5801
Hydraulic Oil Filter.....	H-5522
Hydraulic Oil Filter.....	HC-55170
330D (EXCAVATORS) S/N: NBD1-UP	
Air Filter Secondary.....	A-8651
Cabin Air Filter.....	CA-55850
Hydraulic Oil Filter.....	HC-55170
Hydraulic Oil Filter.....	H-5522
Hydraulic Oil Filter.....	HC-5801
330D (EXCAVATORS) S/N: RAS1-UP	
Air Filter Secondary.....	A-8651
Cabin Air Filter.....	CA-55850
Hydraulic Oil Filter.....	HC-5801
Hydraulic Oil Filter.....	H-5522
Hydraulic Oil Filter.....	HC-55170
330D (EXCAVATORS) S/N: T2Y1-UP	
Air Filter Secondary.....	A-8651
Cabin Air Filter.....	CA-55850
Hydraulic Oil Filter.....	HC-55170
Hydraulic Oil Filter.....	H-5522
Hydraulic Oil Filter.....	HC-5801
330D (EXCAVATORS) S/N: THJ1-UP	
Air Filter Secondary.....	A-8651
Cabin Air Filter.....	CA-55850
Hydraulic Oil Filter.....	HC-5801
Hydraulic Oil Filter.....	H-5522
Hydraulic Oil Filter.....	HC-55170
330 LME (EXCAVATORS)	
Air Filter Primary.....	A-28710
Air Filter Set.....	A-28730-S
Air Filter Secondary.....	A-7967
Hydraulic Oil Filter.....	H-5505
Hydraulic Oil Filter.....	HC-5505
Oil Filter Full Flow.....	C-5510
330B L (EXCAVATORS) CAT 3306 (S/N: 1J51-UP)	
Air Filter Primary.....	A-5558
Air Filter Secondary.....	A-5559
Fuel Filter.....	F-5505
Fuel Filter Secondary.....	FC-5507

MODEL/APPLICATION	SAKURA NO	MODEL/APPLICATION	SAKURA NO	MODEL/APPLICATION	SAKURA NO
CATERPILLAR		CATERPILLAR		CATERPILLAR	
330B L (EXCAVATORS) CAT 3306 (S/N: 1JS1-UP)		Air Filter Primary.....	A-5558	Oil Filter Full Flow.....	C-5510
Hydraulic Oil Filter.....	HC-5801	Air Filter Secondary.....	A-5559	3306B (GENERATORS)	
Hydraulic Oil Filter.....	HC-5505	Fuel Filter.....	F-5505	Air Filter Primary.....	A-5535M
Hydraulic Oil Filter.....	H-7942	Fuel Filter Secondary.....	FC-5507	Air Filter Set.....	A-5573M-S
Oil Filter Full Flow.....	C-5510	Hydraulic Oil Filter.....	HC-5801	Fuel Filter.....	FC-55014
330B L (EXCAVATORS) CAT 3306 (S/N: 3YR1-UP)		Hydraulic Oil Filter.....	HC-5505	336E L (EXCAVATORS) CAT C9.3 ACERT	
Air Filter Secondary.....	A-5559	Hydraulic Oil Filter.....	H-7942	Hydraulic Oil Filter.....	HC-9901
Air Filter Primary.....	A-5558	Oil Filter Full Flow.....	C-5510	336E (EXCAVATORS) W/C9.3L ENG.	
Fuel Filter Secondary.....	FC-5507	330B L (EXCAVATORS) CAT 3306 (S/N: 8TR1-UP)		Fuel/Water Separator.....	SFC-55250
Fuel Filter.....	F-5505	Air Filter Secondary.....	A-5559	336E LNH (EXCAVATORS) W/C9.3L ENG.	
Hydraulic Oil Filter.....	H-7942	Air Filter Primary.....	A-5558	Fuel/Water Separator.....	SFC-55250
Hydraulic Oil Filter.....	HC-5505	Fuel Filter Secondary.....	FC-5507	336F (EXCAVATORS) W/C9.3L ENG.	
Hydraulic Oil Filter.....	HC-5801	Fuel Filter.....	F-5505	Fuel/Water Separator.....	SFC-55250
Oil Filter Full Flow.....	C-5510	Hydraulic Oil Filter.....	H-7942	336F XE (EXCAVATORS) W/C9.3L ENG.	
330B L (EXCAVATORS) CAT 3306 (S/N: 4RS1-UP)		Hydraulic Oil Filter.....	HC-5505	Fuel/Water Separator.....	SFC-55250
Air Filter Primary.....	A-5558	Hydraulic Oil Filter.....	HC-5801	340F (EXCAVATORS) W/C9.3L ENG.	
Air Filter Secondary.....	A-5559	Oil Filter Full Flow.....	C-5510	Fuel/Water Separator.....	SFC-55250
Fuel Filter.....	F-5505	330B L (EXCAVATORS) S/N: 3YR1-UP		340F L LRE (EXCAVATORS) W/C9.3L ENG.	
Fuel Filter Secondary.....	FC-5507	Air Filter Primary.....	A-5558	Fuel/Water Separator.....	SFC-55250
Hydraulic Oil Filter.....	HC-5801	Air Filter Secondary.....	A-5559	345B (EXCAVATORS) CAT 3176 (S/N: 2NW1-UP)	
Hydraulic Oil Filter.....	HC-5505	Fuel Filter.....	F-5505	Air Filter Primary.....	A-5593
Hydraulic Oil Filter.....	H-7942	Fuel Filter Secondary.....	FC-5507	Air Filter Set.....	A-5595-S
Oil Filter Full Flow.....	C-5510	Hydraulic Oil Filter.....	HC-5801	Air Filter Secondary.....	A-5594
330B L (EXCAVATORS) CAT 3306 (S/N: 5LR1-UP)		Hydraulic Oil Filter.....	HC-5505	Fuel Filter.....	FC-5517
Air Filter Secondary.....	A-5559	Hydraulic Oil Filter.....	HC-55170	Fuel/Water Separator Secondary..	SFC-5504-10
Air Filter Primary.....	A-5558	Hydraulic Oil Filter.....	H-7942	Fuel/Water Separator Secondary..	SFC-5504-10B
Fuel Filter Secondary.....	FC-5507	Hydraulic Oil Filter.....	H-7942	Hydraulic Oil Filter.....	HC-5801
Fuel Filter.....	F-5505	Oil Filter Full Flow.....	C-5510	Hydraulic Oil Filter.....	H-7942
Hydraulic Oil Filter.....	H-7942	330B L US (EXCAVATORS) CAT 3304B (S/N: 6DR1-UP)		Hydraulic Oil Filter.....	HC-5505
Hydraulic Oil Filter.....	HC-5505	Air Filter Secondary.....	A-5559	Hydraulic Oil Filter.....	HC-5801
Hydraulic Oil Filter.....	HC-5801	Air Filter Primary.....	A-5558	Oil Filter Full Flow.....	C-5510
Oil Filter Full Flow.....	C-5510	Cabin Air Filter.....	CA-55850	330B LN (EXCAVATORS) CAT 3306 (S/N: 3YR1-UP)	
330B L (EXCAVATORS) CAT 3306 (S/N: 5LS1-UP)		Fuel Filter.....	F-5505	Air Filter Secondary.....	A-5559
Air Filter Primary.....	A-5558	Fuel Filter Secondary.....	FC-5507	Air Filter Primary.....	A-5558
Air Filter Secondary.....	A-5559	Hydraulic Oil Filter.....	HC-5801	Fuel Filter.....	F-5505
Fuel Filter.....	F-5505	Hydraulic Oil Filter.....	H-7942	Fuel Filter Secondary.....	FC-5507
Fuel Filter Secondary.....	FC-5507	Hydraulic Oil Filter.....	HC-5505	Hydraulic Oil Filter.....	HC-5505
Hydraulic Oil Filter.....	HC-5801	Hydraulic Oil Filter.....	H-7942	Hydraulic Oil Filter.....	H-7942
Hydraulic Oil Filter.....	HC-5505	Hydraulic Oil Filter.....	HC-5801	Fuel/Water Separator Secondary..	SFC-5504-10B
Hydraulic Oil Filter.....	H-7942	Oil Filter Full Flow.....	C-5510	Fuel/Water Separator Secondary..	SFC-5504-10
Oil Filter Full Flow.....	C-5510	330B LN (EXCAVATORS) CAT 3306 (S/N: 5LR1-UP)		Hydraulic Oil Filter.....	HC-5505
330B L (EXCAVATORS) CAT 3306 (S/N: 6DR1-UP)		Air Filter Secondary.....	A-5559	Hydraulic Oil Filter.....	H-7942
Air Filter Secondary.....	A-5559	Air Filter Primary.....	A-5558	Hydraulic Oil Filter.....	HC-5801
Air Filter Primary.....	A-5558	Fuel Filter.....	F-5505	Oil Filter Full Flow.....	C-5516
Fuel Filter Secondary.....	FC-5507	Fuel Filter Secondary.....	FC-5507	345B (EXCAVATORS) CAT 3176 (S/N: 2SW1-UP)	
Fuel Filter.....	F-5505	Hydraulic Oil Filter.....	HC-5505	Air Filter Secondary.....	A-5594
Hydraulic Oil Filter.....	HC-5801	Hydraulic Oil Filter.....	H-7942	Air Filter Set.....	A-5595-S
Hydraulic Oil Filter.....	H-7942	Hydraulic Oil Filter.....	HC-5801	Air Filter Primary.....	A-5593
Oil Filter Full Flow.....	C-5510	Oil Filter Full Flow.....	C-5510	Fuel Filter.....	FC-5517
330B L (EXCAVATORS) CAT 3306 (S/N: 8SR1-UP)		330B LN (EXCAVATORS) CAT 3306 (S/N: 5LR1-UP)		Fuel/Water Separator Secondary..	SFC-5504-10B
Air Filter Secondary.....	A-5559	Air Filter Secondary.....	A-5559	Fuel/Water Separator Secondary..	SFC-5504-10
Air Filter Primary.....	A-5558	Air Filter Primary.....	A-5558	Hydraulic Oil Filter.....	HC-5505
Fuel Filter Secondary.....	FC-5507	Fuel Filter Secondary.....	FC-5507	Hydraulic Oil Filter.....	H-7942
Fuel Filter.....	F-5505	Fuel Filter.....	F-5505	Hydraulic Oil Filter.....	HC-5801
Hydraulic Oil Filter.....	H-7942	Hydraulic Oil Filter.....	H-7942	Oil Filter Full Flow.....	C-5516
Hydraulic Oil Filter.....	HC-5505	Hydraulic Oil Filter.....	HC-5505	345B (EXCAVATORS) CAT 3176 (S/N: 2ZW1-UP)	
Hydraulic Oil Filter.....	HC-5801	Hydraulic Oil Filter.....	HC-5801	Air Filter Secondary.....	A-8580
Oil Filter Full Flow.....	C-5510	Hydraulic Oil Filter.....	HC-5801	Air Filter Primary.....	A-8665M
330B L (EXCAVATORS) CAT 3306 (S/N: 8SR1-UP)		330B LN (EXCAVATORS) CAT 3306 (S/N: 5LR1-UP)		Fuel Filter.....	FC-5517
Air Filter Secondary.....	A-5559	Air Filter Secondary.....	A-5559	Fuel/Water Separator Secondary..	SFC-5504-10
Air Filter Primary.....	A-5558	Air Filter Primary.....	A-5558		
Fuel Filter Secondary.....	FC-5507	Fuel Filter Secondary.....	FC-5507		
Fuel Filter.....	F-5505	Fuel Filter.....	F-5505		
Hydraulic Oil Filter.....	H-7942	Hydraulic Oil Filter.....	H-7942		
Hydraulic Oil Filter.....	HC-5505	Hydraulic Oil Filter.....	HC-5505		
Hydraulic Oil Filter.....	HC-5801	Hydraulic Oil Filter.....	HC-5801		
Oil Filter Full Flow.....	C-5510	Hydraulic Oil Filter.....	HC-5801		

MODEL/APPLICATION	SAKURA NO
-------------------	-----------

CATERPILLAR

345B
(EXCAVATORS)
S/N: 7KS00365-UP

Air Filter Primary.....	A-8665M
Cabin Air Filter.....	CA-55850
Fuel Filter.....	FC-5517
Fuel/Water Separator Secondary..	SFC-5504-10B
Fuel/Water Separator Secondary..	SFC-5504-10
Hydraulic Oil Filter.....	H-7942
Hydraulic Oil Filter.....	HC-5505
Oil Filter Full Flow.....	C-5516

345B L
(EXCAVATORS)
CAT 3176C (S/N: 2SW1-UP)

Air Filter Primary.....	A-8665M
Air Filter Secondary.....	A-8580
Fuel Filter.....	FC-5517
Fuel/Water Separator Secondary..	SFC-5504-10
Fuel/Water Separator Secondary..	SFC-5504-10B
Hydraulic Oil Filter.....	HC-5505
Hydraulic Oil Filter.....	H-7942
Hydraulic Oil Filter.....	HC-5801

345B L
(EXCAVATORS)
CAT 3176C (S/N: 2WS1-UP)

Air Filter Secondary.....	A-8580
Air Filter Primary.....	A-8665M
Cabin Air Filter.....	CA-55850
Fuel Filter.....	FC-5517
Hydraulic Oil Filter.....	HC-5801
Hydraulic Oil Filter.....	H-7942
Hydraulic Oil Filter.....	HC-5505

345B L
(EXCAVATORS)
CAT 3176C (S/N: 2ZW1-UP)

Air Filter Primary.....	A-8665M
Air Filter Secondary.....	A-8580
Fuel Filter.....	FC-5517
Fuel/Water Separator Secondary..	SFC-5504-10B
Fuel/Water Separator Secondary..	SFC-5504-10
Hydraulic Oil Filter.....	HC-5505
Hydraulic Oil Filter.....	H-7942
Hydraulic Oil Filter.....	HC-5801

345B L
(EXCAVATORS)
CAT 3176C (S/N: 3MM1-UP)

Air Filter Secondary.....	A-8580
Air Filter Primary.....	A-8665M
Fuel Filter.....	FC-5517
Fuel/Water Separator Secondary..	SFC-5504-10
Fuel/Water Separator Secondary..	SFC-5504-10B
Hydraulic Oil Filter.....	HC-5801
Hydraulic Oil Filter.....	H-7942
Hydraulic Oil Filter.....	HC-5505

345B L
(EXCAVATORS)
CAT 3176C (S/N: 4SS1-UP)

Air Filter Secondary.....	A-5594
Air Filter Set.....	A-5595-S
Air Filter Primary.....	A-5593
Fuel Filter.....	FC-5517
Fuel/Water Separator Secondary..	SFC-5504-10B
Fuel/Water Separator Secondary..	SFC-5504-10
Hydraulic Oil Filter.....	HC-5505
Hydraulic Oil Filter.....	H-7942

MODEL/APPLICATION	SAKURA NO
-------------------	-----------

CATERPILLAR

Hydraulic Oil Filter.....	HC-5801
---------------------------	---------

345B L
(EXCAVATORS)
CAT 3176C (S/N: 5WS1-UP)

Air Filter Primary.....	A-5593
Air Filter Set.....	A-5595-S
Air Filter Secondary.....	A-5594
Air Filter Secondary.....	A-8580
Air Filter Primary.....	A-8665M
Fuel Filter.....	FC-5517
Fuel/Water Separator Secondary..	SFC-5504-10
Fuel/Water Separator Secondary..	SFC-5504-10B
Hydraulic Oil Filter.....	HC-5801
Hydraulic Oil Filter.....	H-7942
Hydraulic Oil Filter.....	HC-5505
Oil Filter Full Flow.....	C-5516

345B L
(EXCAVATORS)
CAT 3176C (S/N: 6XS1-UP)

Air Filter Primary.....	A-8665M
Air Filter Secondary.....	A-8580
Fuel Filter.....	FC-5517
Fuel/Water Separator Secondary..	SFC-5504-10B
Fuel/Water Separator Secondary..	SFC-5504-10
Hydraulic Oil Filter.....	HC-5505
Hydraulic Oil Filter.....	H-7942
Hydraulic Oil Filter.....	HC-5801

345B L
(EXCAVATORS)
CAT 3176C (S/N: 7KS1-UP)

Air Filter Secondary.....	A-8580
Air Filter Primary.....	A-8665M
Cabin Air Filter.....	CA-55850
Fuel Filter.....	FC-5517
Fuel/Water Separator Secondary..	SFC-5504-10
Fuel/Water Separator Secondary..	SFC-5504-10B
Hydraulic Oil Filter.....	HC-5801
Hydraulic Oil Filter.....	H-7942
Hydraulic Oil Filter.....	HC-5505

345B L
(EXCAVATORS)
CAT 3176C (S/N: 9GS1-UP)

Air Filter Secondary.....	A-5594
Air Filter Set.....	A-5595-S
Air Filter Primary.....	A-5593
Fuel Filter.....	FC-5517
Fuel/Water Separator Secondary..	SFC-5504-10B
Fuel/Water Separator Secondary..	SFC-5504-10
Hydraulic Oil Filter.....	HC-5505
Hydraulic Oil Filter.....	H-7942
Hydraulic Oil Filter.....	HC-5801

345B L
(EXCAVATORS)
CAT 3176C (S/N: BFG1-UP)

Air Filter Secondary.....	A-8580
Air Filter Primary.....	A-8665M
Fuel Filter.....	FC-5517
Fuel/Water Separator Secondary..	SFC-5504-10
Fuel/Water Separator Secondary..	SFC-5504-10B
Hydraulic Oil Filter.....	HC-5801
Hydraulic Oil Filter.....	H-7942
Hydraulic Oil Filter.....	HC-5505

MODEL/APPLICATION	SAKURA NO
-------------------	-----------

CATERPILLAR

345
(EXCAVATORS)
S/N: 7SK00365-UP

Air Filter Secondary.....	A-8580
Air Filter Primary.....	A-8665M
Cabin Air Filter.....	CA-55850
Fuel Filter.....	FC-5517
Fuel/Water Separator Secondary..	SFC-5504-10
Fuel/Water Separator Secondary..	SFC-5504-10B
Hydraulic Oil Filter.....	H-7942
Hydraulic Oil Filter.....	HC-5505
Oil Filter Full Flow.....	C-5516

345D
(EXCAVATORS)
CAT C13 ACERT

Hydraulic Oil Filter.....	HC-9901
---------------------------	---------

345 BLME
(EXCAVATORS)

Air Filter Primary.....	A-8665M
Air Filter Secondary.....	A-8580
Fuel/Water Separator Secondary..	SFC-5504-10B
Fuel/Water Separator Secondary..	SFC-5504-10
Hydraulic Oil Filter.....	HC-5505
Hydraulic Oil Filter.....	H-7942
Oil Filter Full Flow.....	C-5516
Oil Filter Full Flow.....	C-5510

345B II
(EXCAVATORS)
CAT 3176C (S/N: AGS1-UP)

Air Filter Primary.....	A-5593
Air Filter Set.....	A-5595-S
Air Filter Secondary.....	A-5594
Cabin Air Filter.....	CA-55850
Fuel Filter.....	FC-5517
Fuel/Water Separator Secondary..	SFC-5504-10
Fuel/Water Separator Secondary..	SFC-5504-10B
Hydraulic Oil Filter.....	HC-5801
Hydraulic Oil Filter.....	HC-5505
Hydraulic Oil Filter.....	H-7942
Oil Filter Full Flow.....	C-5516

345B II
(EXCAVATORS)
CAT 3176C (S/N: AKJ1-UP)

Air Filter Set.....	A-5595-S
Air Filter Primary.....	A-5593
Cabin Air Filter.....	CA-55850
Fuel Filter.....	FC-5517
Hydraulic Oil Filter.....	HC-5801
Oil Filter Full Flow.....	C-5516

345B II
(EXCAVATORS)
CAT 3176C (S/N: AKX1-UP)

Air Filter Primary.....	A-5593
Air Filter Set.....	A-5595-S
Air Filter Secondary.....	A-5594
Cabin Air Filter.....	CA-55850
Fuel Filter.....	FC-5517
Fuel/Water Separator Secondary..	SFC-5504-10B
Fuel/Water Separator Secondary..	SFC-5504-10
Hydraulic Oil Filter.....	HC-5801
Hydraulic Oil Filter.....	H-7942
Oil Filter Full Flow.....	C-5516

MODEL/APPLICATION	SAKURA NO
CATERPILLAR	
345B II (EXCAVATORS) CAT 3176C (S/N: ALB1-UP)	
Air Filter Set.....	A-5595-S
Air Filter Primary.....	A-5593
Air Filter Secondary.....	A-5594
Cabin Air Filter.....	CA-55850
Fuel Filter.....	FC-5517
Fuel/Water Separator Secondary..	SFC-5504-10B
Fuel/Water Separator Secondary..	SFC-5504-10B
Hydraulic Oil Filter.....	H-7942
Hydraulic Oil Filter.....	HC-5801
345B II (EXCAVATORS) CAT 3176C (S/N: ALD1-UP)	
Air Filter Primary.....	A-5593
Air Filter Set.....	A-5595-S
Air Filter Secondary.....	A-5594
Cabin Air Filter.....	CA-55850
Fuel Filter.....	FC-5517
Fuel/Water Separator Secondary..	SFC-5504-10B
Fuel/Water Separator Secondary..	SFC-5504-10B
Hydraulic Oil Filter.....	HC-5801
Hydraulic Oil Filter.....	H-7942
345B II (EXCAVATORS) CAT 3176C (S/N: CCC1-UP)	
Air Filter Secondary.....	A-8580
Air Filter Primary.....	A-8665M
Fuel Filter.....	FC-5517
Fuel/Water Separator Secondary..	SFC-5504-10B
Fuel/Water Separator Secondary..	SFC-5504-10B
345B L II (EXCAVATORS) CAT 3176C (S/N: AGS1-UP)	
Air Filter Secondary.....	A-5594
Air Filter Set.....	A-5595-S
Air Filter Primary.....	A-5593
Fuel Filter.....	FC-5517
Fuel/Water Separator Secondary..	SFC-5504-10B
Fuel/Water Separator Secondary..	SFC-5504-10B
Hydraulic Oil Filter.....	HC-5505
Hydraulic Oil Filter.....	H-7942
Hydraulic Oil Filter.....	HC-5801
345B L II (EXCAVATORS) CAT 3176C (S/N: AKJ1-UP)	
Air Filter Primary.....	A-5593
Air Filter Set.....	A-5595-S
Air Filter Secondary.....	A-5594
Fuel Filter.....	FC-5517
Fuel/Water Separator Secondary..	SFC-5504-10B
Fuel/Water Separator Secondary..	SFC-5504-10B
Hydraulic Oil Filter.....	HC-5801
Hydraulic Oil Filter.....	H-7942
Hydraulic Oil Filter.....	HC-5505
Hydraulic Oil Filter.....	H-5522
345B L II (EXCAVATORS) CAT 3176C (S/N: AKX1-UP)	
Air Filter Set.....	A-5595-S
Air Filter Primary.....	A-5593
Air Filter Secondary.....	A-5594
Fuel Filter.....	FC-5517

MODEL/APPLICATION	SAKURA NO
CATERPILLAR	
Fuel/Water Separator Secondary.. SFC-5504-10B	
Fuel/Water Separator Secondary... SFC-5504-10	
Hydraulic Oil Filter.....	HC-5505
Hydraulic Oil Filter.....	H-5522
Hydraulic Oil Filter.....	H-7942
Hydraulic Oil Filter.....	HC-5801
345B L II (EXCAVATORS) CAT 3176C (S/N: ALB1-UP)	
Air Filter Secondary.....	A-5594
Air Filter Primary.....	A-5593
Air Filter Set.....	A-5595-S
Fuel Filter.....	FC-5517
Fuel/Water Separator Secondary..	SFC-5504-10B
Fuel/Water Separator Secondary..	SFC-5504-10B
Hydraulic Oil Filter.....	HC-5801
Hydraulic Oil Filter.....	H-7942
Hydraulic Oil Filter.....	HC-5505
345B L II (EXCAVATORS) CAT 3176C (S/N: ALD1-UP)	
Air Filter Secondary.....	A-5594
Air Filter Set.....	A-5595-S
Air Filter Primary.....	A-5593
Fuel Filter.....	FC-5517
Fuel/Water Separator Secondary..	SFC-5504-10B
Fuel/Water Separator Secondary..	SFC-5504-10B
Hydraulic Oil Filter.....	HC-5801
Hydraulic Oil Filter.....	H-7942
Hydraulic Oil Filter.....	HC-5505
345B L II (EXCAVATORS) CAT 3176C (S/N: 4SS1-UP)	
Air Filter Primary.....	A-5593
Air Filter Set.....	A-5595-S
Air Filter Secondary.....	A-5594
Cabin Air Filter.....	CA-55850
Fuel Filter.....	FC-5517
Hydraulic Oil Filter.....	HC-5505
Hydraulic Oil Filter.....	HC-5801
345B LC (EXCAVATORS) CAT 3176C (S/N: 2SW1-UP)	
Air Filter Primary.....	A-8665M
Air Filter Secondary.....	A-8580
Fuel Filter.....	FC-5517
Fuel/Water Separator Secondary..	SFC-5504-10B
Fuel/Water Separator Secondary..	SFC-5504-10B
Hydraulic Oil Filter.....	HC-5505
Hydraulic Oil Filter.....	HC-5801
Hydraulic Oil Filter.....	H-7942
345B LC (EXCAVATORS) CAT 3176C (S/N: 7KS1-UP)	
Air Filter Secondary.....	A-8580
Air Filter Primary.....	A-8665M
Fuel Filter.....	FC-5517
Fuel/Water Separator Secondary..	SFC-5504-10B
Fuel/Water Separator Secondary..	SFC-5504-10B
Hydraulic Oil Filter.....	H-7942
Hydraulic Oil Filter.....	HC-5505
Hydraulic Oil Filter.....	HC-5801

MODEL/APPLICATION	SAKURA NO
CATERPILLAR	
345B LC (EXCAVATORS) CAT 3176C (S/N: BFG1-UP)	
Air Filter Primary.....	A-8665M
Air Filter Secondary.....	A-8580
Fuel Filter.....	FC-5517
Fuel/Water Separator Secondary..	SFC-5504-10B
Fuel/Water Separator Secondary..	SFC-5504-10B
Hydraulic Oil Filter.....	HC-5505
Hydraulic Oil Filter.....	H-7942
Hydraulic Oil Filter.....	HC-5801
345C (EXCAVATORS) CAT C13 ACERT	
Hydraulic Oil Filter.....	HC-9901
345C (EXCAVATORS) S/N: DHP1-382-UP	
Air Filter Primary.....	A-5593
Air Filter Secondary.....	A-5594
Air Filter Set.....	A-5595-S
Cabin Air Filter.....	CA-55850
Hydraulic Oil Filter.....	H-5522
Hydraulic Oil Filter.....	H-7942
Hydraulic Oil Filter.....	HC-55170
Hydraulic Oil Filter.....	HC-5801
345C (EXCAVATORS) S/N: DHP383-UP	
Air Filter Set.....	A-5595-S
Air Filter Secondary.....	A-5594
Air Filter Primary.....	A-5593
Cabin Air Filter.....	CA-55850
Hydraulic Oil Filter.....	HC-5801
Hydraulic Oil Filter.....	HC-55170
Hydraulic Oil Filter.....	H-5522
345C (EXCAVATORS) S/N: ELS1-UP	
Air Filter Primary.....	A-5593
Air Filter Secondary.....	A-5594
Air Filter Set.....	A-5595-S
Air Filter Primary.....	A-8665M
Air Filter Secondary.....	A-8580
Cabin Air Filter.....	CA-55850
Hydraulic Oil Filter.....	HC-5801
345C (EXCAVATORS) S/N: GCL1-UP	
Air Filter Secondary.....	A-8580
Air Filter Primary.....	A-8665M
Air Filter Set.....	A-5595-S
Air Filter Secondary.....	A-5594
Air Filter Primary.....	A-5593
Cabin Air Filter.....	CA-55850
Hydraulic Oil Filter.....	HC-5801
345C (EXCAVATORS) S/N: GJR1-UP	
Air Filter Primary.....	A-5593
Air Filter Secondary.....	A-5594
Air Filter Set.....	A-5595-S
Cabin Air Filter.....	CA-55850
Hydraulic Oil Filter.....	HC-5801
Hydraulic Oil Filter.....	H-5522

MODEL/APPLICATION	SAKURA NO
CATERPILLAR	
345C (EXCAVATORS) S/N: G3R1-UP	
Hydraulic Oil Filter.....	HC-55170
Hydraulic Oil Filter.....	H-7942
345C (EXCAVATORS) S/N: GPH1-UP	
Air Filter Set.....	A-5595-S
Air Filter Secondary.....	A-5594
Air Filter Primary.....	A-8665M
Air Filter Secondary.....	A-8580
Air Filter Primary.....	A-5593
Cabin Air Filter.....	CA-55850
Hydraulic Oil Filter.....	HC-5801
345C (EXCAVATORS) S/N: LYS1-YP-UP	
Air Filter Secondary.....	A-8580
Air Filter Primary.....	A-8665M
Air Filter Secondary.....	A-5594
Air Filter Set.....	A-5595-S
Air Filter Primary.....	A-5593
Cabin Air Filter.....	CA-55850
Hydraulic Oil Filter.....	HC-5801
345C (EXCAVATORS) S/N: SPC1-UP	
Air Filter Set.....	A-5595-S
Air Filter Secondary.....	A-5594
Air Filter Primary.....	A-8665M
Air Filter Secondary.....	A-8580
Air Filter Primary.....	A-5593
Cabin Air Filter.....	CA-55850
Hydraulic Oil Filter.....	HC-5801
345C (EXCAVATORS) S/N: TBA1-UP	
Air Filter Secondary.....	A-8580
Air Filter Primary.....	A-8665M
Air Filter Secondary.....	A-5594
Air Filter Set.....	A-5595-S
Air Filter Primary.....	A-5593
Cabin Air Filter.....	CA-55850
Hydraulic Oil Filter.....	HC-5801
345C (EXCAVATORS) S/N: WDE1-UP	
Air Filter Set.....	A-5595-S
Air Filter Secondary.....	A-5594
Air Filter Primary.....	A-8665M
Air Filter Secondary.....	A-8580
Air Filter Primary.....	A-5593
Cabin Air Filter.....	CA-55850
Hydraulic Oil Filter.....	HC-5801
345D VG (EXCAVATORS) w/C13 Eng.	
Fuel/Water Separator.....	SFC-55250
348 (EXCAVATORS) S/N: 3GJ01501-UP	
Fuel Filter.....	F-5501
Oil Filter Full Flow.....	O-5502

MODEL/APPLICATION	SAKURA NO
CATERPILLAR	
350 (EXCAVATORS) CAT 3116 (S/N: 2ZL1-UP)	
Coolant Filter.....	WC-5707
Coolant Filter.....	WC-5705
Fuel Filter.....	F-5505
Fuel Filter Secondary.....	FC-5507
Hydraulic Oil Filter.....	H-5505
350 (EXCAVATORS) CAT 3116 (S/N: 3ML1-UP)	
Air Filter Secondary.....	A-5594
Air Filter Primary.....	A-5593
Air Filter Set.....	A-5595-S
Fuel Filter Secondary.....	FC-5507
Fuel Filter.....	F-5505
Hydraulic Oil Filter.....	HC-5516
Hydraulic Oil Filter.....	H-5505
Oil Filter Full Flow.....	C-5516
350 (EXCAVATORS) CAT 3116 (S/N: 7RK1-UP)	
Air Filter Set.....	A-5595-S
Air Filter Primary.....	A-5593
Air Filter Secondary.....	A-5594
Fuel Filter.....	F-5505
Fuel Filter Secondary.....	FC-5507
Hydraulic Oil Filter.....	HC-5516
Hydraulic Oil Filter.....	H-5505
Oil Filter Full Flow.....	C-5516
350 (EXCAVATORS) CAT 3116 (S/N: 8HK1-UP)	
Air Filter Secondary.....	A-5594
Air Filter Primary.....	A-5593
Air Filter Set.....	A-5595-S
Fuel Filter Secondary.....	FC-5507
Fuel Filter.....	F-5505
Hydraulic Oil Filter.....	H-5505
Hydraulic Oil Filter.....	HC-5516
Oil Filter Full Flow.....	C-5516
350 (EXCAVATORS) CAT 3116 (S/N: 9DK1-UP)	
Air Filter Set.....	A-5595-S
Air Filter Primary.....	A-5593
Air Filter Secondary.....	A-5594
Fuel Filter.....	F-5505
Fuel Filter Secondary.....	FC-5507
Hydraulic Oil Filter.....	HC-5516
Hydraulic Oil Filter.....	H-5505
Oil Filter Full Flow.....	C-5516
350 (EXCAVATORS) CAT 3116 (S/N: 9FL1-UP)	
Air Filter Secondary.....	A-5594
Air Filter Primary.....	A-5593
Air Filter Set.....	A-5595-S
Fuel Filter Secondary.....	FC-5507
Fuel Filter.....	F-5505
Hydraulic Oil Filter.....	HC-5516
Hydraulic Oil Filter.....	H-5505
Oil Filter Full Flow.....	C-5516
350B (EXCAVATORS)	
Fuel Filter Secondary.....	FC-5507
Oil Filter Full Flow.....	C-5510
35 (TRACTORS) S/N: 1TJ1-UP	
Air Filter Primary.....	A-5549M
Air Filter Primary.....	A-5549

MODEL/APPLICATION	SAKURA NO
CATERPILLAR	
350 (EXCAVATORS) CAT 3306 (S/N: 3ML1-UP)	
Air Filter Set.....	A-5595-S
Air Filter Primary.....	A-5593
Air Filter Secondary.....	A-5594
Fuel Filter.....	F-5505
Fuel Filter Secondary.....	FC-5507
Hydraulic Oil Filter.....	HC-5516
Hydraulic Oil Filter.....	H-5505
Oil Filter Full Flow.....	C-5516
350 (EXCAVATORS) CAT 3306 (S/N: 7RK1-UP)	
Air Filter Secondary.....	A-5594
Air Filter Primary.....	A-5593
Air Filter Set.....	A-5595-S
Fuel Filter Secondary.....	FC-5507
Fuel Filter.....	F-5505
Hydraulic Oil Filter.....	HC-5516
Hydraulic Oil Filter.....	H-5505
Oil Filter Full Flow.....	C-5516
350 (EXCAVATORS) CAT 3306 (S/N: 8HK1-UP)	
Air Filter Set.....	A-5595-S
Air Filter Primary.....	A-5593
Air Filter Secondary.....	A-5594
Fuel Filter.....	F-5505
Fuel Filter Secondary.....	FC-5507
Hydraulic Oil Filter.....	HC-5516
Hydraulic Oil Filter.....	H-5505
Oil Filter Full Flow.....	C-5516
350 (EXCAVATORS) CAT 3306 (S/N: 9DK1-UP)	
Air Filter Secondary.....	A-5594
Air Filter Primary.....	A-5593
Air Filter Set.....	A-5595-S
Fuel Filter Secondary.....	FC-5507
Fuel Filter.....	F-5505
Hydraulic Oil Filter.....	HC-5516
Hydraulic Oil Filter.....	H-5505
Oil Filter Full Flow.....	C-5516
350 (EXCAVATORS) CAT 3306 (S/N: 9FL1-UP)	
Air Filter Set.....	A-5595-S
Air Filter Primary.....	A-5593
Air Filter Secondary.....	A-5594
Fuel Filter.....	F-5505
Fuel Filter Secondary.....	FC-5507
Hydraulic Oil Filter.....	HC-5516
Hydraulic Oil Filter.....	H-5505
Oil Filter Full Flow.....	C-5516
350B (EXCAVATORS)	
Fuel Filter Secondary.....	FC-5507
Oil Filter Full Flow.....	C-5510
35 (TRACTORS) S/N: 1TJ1-UP	
Air Filter Primary.....	A-5549M
Air Filter Primary.....	A-5549

Sakura Filter

ENGINE APPLICATION

MODEL/APPLICATION	SAKURA NO	MODEL/APPLICATION	SAKURA NO	MODEL/APPLICATION	SAKURA NO
CATERPILLAR		CATERPILLAR		CATERPILLAR	
35 (TRACTORS) S/N: 1TJ1-UP		3516 (GENERATORS) 3516 Natural Gas		Fuel Filter Secondary.....	FC-55151
Air Filter Set.....	A-5549M-S	Air Filter Set.....	A-4403-S	Oil Filter Full Flow.....	C-5510
Air Filter Secondary.....	A-5550	Air Filter.....	A-4403		
Hydraulic Oil Filter.....	HC-5504				
35 (TRACTORS) S/N: 3HS1-UP		3516 (GENERATORS)		365B (EXCAVATORS) CAT 3196 (S/N: 9PZ1-UP) , 2007-UP	
Air Filter Secondary.....	A-5550	Air Filter Set.....	A-5551-S	Air Filter Primary.....	A-5593
Air Filter Set.....	A-5549M-S	Air Filter.....	A-5551	Air Filter Secondary.....	A-5594
Air Filter Primary.....	A-5549	Fuel/Water Separator Final.....	SF-1912-2	Air Filter Set.....	A-5595-S
Air Filter Primary.....	A-5549M			Fuel Filter.....	FC-5517
Hydraulic Oil Filter.....	HC-5504	3512 (GENERATORS) 3512 Gen Set Eng.		Fuel/Water Separator Secondary... SFC-5504-10	
		Air Filter Set.....	A-4403-S	Fuel/Water Separator Secondary.. SFC-5504-10B	
		Air Filter.....	A-4403	Hydraulic Oil Filter.....	H-7942
				Hydraulic Oil Filter.....	HC-5516
				Hydraulic Oil Filter.....	H-5522
35 (TRACTORS) S/N: 8RD1-UP		3512 (GENERATORS) 3512 Industrial		365B (EXCAVATORS) CAT 3196 (S/N: 9TZ1-UP)	
Air Filter Primary.....	A-5549M	Air Filter.....	A-4403	Air Filter Primary.....	A-5593
Air Filter Primary.....	A-5549	Air Filter Set.....	A-4403-S	Air Filter Set.....	A-5595-S
Air Filter Set.....	A-5549M-S			Air Filter Secondary.....	A-5594
Air Filter Secondary.....	A-5550	3512 (GENERATORS) 3512 Locomotive		Fuel Filter.....	FC-5517
Hydraulic Oil Filter.....	HC-5504	Air Filter Set.....	A-4403-S	Fuel/Water Separator Secondary.. SFC-5504-10	
		Air Filter.....	A-4403	Fuel/Water Separator Secondary.. SFC-5504-10B	
				Hydraulic Oil Filter.....	H-7942
				Hydraulic Oil Filter.....	HC-5516
35 (TRACTORS) S/N: ADK1-UP		3512B (GENERATORS) 3512B		365B (EXCAVATORS) CAT 3196 (S/N: CFJ1-UP)	
Air Filter Secondary.....	A-5550	Air Filter.....	A-4403	Air Filter Secondary.....	A-5594
Air Filter Set.....	A-5549M-S	Air Filter Set.....	A-4403-S	Air Filter Set.....	A-5595-S
Air Filter Primary.....	A-5549			Air Filter Primary.....	A-5593
Air Filter Primary.....	A-5549M			Cabin Air Filter.....	CA-55850
Hydraulic Oil Filter.....	HC-5504			Fuel Filter.....	FC-5517
				Fuel/Water Separator Secondary.. SFC-5504-10B	
				Fuel/Water Separator Secondary.. SFC-5504-10	
				Hydraulic Oil Filter.....	HC-5516
				Hydraulic Oil Filter.....	H-7942
350BL (EXCAVATORS)		3512B (GENERATORS) 3512B Gen Set Eng.		365B (EXCAVATORS) CAT 3196 (S/N: CTY1-UP)	
Air Filter Primary.....	A-5558	Air Filter Set.....	A-4403-S	Air Filter Primary.....	A-5593
Air Filter Secondary.....	A-5559	Air Filter.....	A-4403	Air Filter Set.....	A-5595-S
Fuel Filter Secondary.....	FC-5507			Fuel Filter.....	FC-5517
Hydraulic Oil Filter.....	H-7942	3512B (GENERATORS) 3512B Industrial		Fuel/Water Separator Secondary.. SFC-5504-10	
Oil Filter Full Flow.....	C-5510	Air Filter.....	A-4403	Fuel/Water Separator Secondary.. SFC-5504-10B	
		Air Filter Set.....	A-4403-S	Hydraulic Oil Filter.....	HC-5516
				Hydraulic Oil Filter.....	H-7942
3508 (GENERATORS) 3508 Gen Set Eng.		3512B (GENERATORS) 3512B Locomotive		365B (EXCAVATORS) CAT 3196 (S/N: DER1-UP)	
Air Filter.....	A-4403	Air Filter Set.....	A-4403-S	Air Filter Secondary.....	A-5594
Air Filter Set.....	A-4403-S	Air Filter.....	A-4403	Air Filter Set.....	A-5595-S
				Fuel Filter.....	FC-5517
3508 (GENERATORS) 3508 Locomotive		3516B (GENERATORS) 3516B		Fuel/Water Separator Secondary.. SFC-5504-10	
Air Filter Set.....	A-4403-S	Air Filter.....	A-4403	Fuel/Water Separator Secondary.. SFC-5504-10B	
Air Filter.....	A-4403	Air Filter Set.....	A-4403-S	Hydraulic Oil Filter.....	H-7942
				Hydraulic Oil Filter.....	HC-5516
3508B (GENERATORS) 3508B Locomotive		3516B (GENERATORS) 3516B Gen Set Eng.		365B (EXCAVATORS) CAT 3196 (S/N: JMB1-UP)	
Air Filter Set.....	A-4403-S	Air Filter.....	A-4403	Air Filter Primary.....	A-5593
Air Filter.....	A-4403	Air Filter Set.....	A-4403-S	Air Filter Set.....	A-5595-S
				Air Filter Primary.....	A-5593
3516 (GENERATORS) 3516		3516B (GENERATORS) 3516B Industrial		Fuel Filter.....	FC-5517
Air Filter.....	A-4403	Air Filter.....	A-4403-S	Fuel/Water Separator Secondary.. SFC-5504-10B	
Air Filter Set.....	A-4403-S	Air Filter Set.....	A-4403	Fuel/Water Separator Secondary.. SFC-5504-10	
				Hydraulic Oil Filter.....	HC-5516
3516 (GENERATORS) 3516 Gen Set Eng.		355 (EXCAVATORS)		Hydraulic Oil Filter.....	H-7942
Air Filter Set.....	A-4403-S	Air Filter Primary.....	AS-5523		
Air Filter.....	A-4403	Air Filter Secondary.....	A-7913		
		Fuel Filter.....	FC-5516		
3516 (GENERATORS) 3516 Industrial		Fuel Filter Secondary.....	FC-5515		
Air Filter.....	A-4403				
Air Filter Set.....	A-4403-S				

MODEL/APPLICATION	SAKURA NO
-------------------	-----------

CATERPILLAR

365B
(EXCAVATORS)
CAT 3196 (S/N: JMB1-UP)
Fuel/Water Separator Secondary.. SFC-5504-10
Fuel/Water Separator Secondary.. SFC-5504-10B
Hydraulic Oil Filter..... H-5522
Hydraulic Oil Filter..... HC-5516

365B
(EXCAVATORS)
CAT 3196 (S/N: PEG1-UP)
Air Filter Secondary..... A-5594
Air Filter Set..... A-5595-S
Air Filter Primary..... A-5593
Fuel Filter..... FC-5517
Fuel/Water Separator Secondary.. SFC-5504-10B
Fuel/Water Separator Secondary.. SFC-5504-10
Hydraulic Oil Filter..... HC-5516
Hydraulic Oil Filter..... H-5522

365B
(EXCAVATORS)
CAT 3196 (S/N: SDL1-UP)
Air Filter Primary..... A-5593
Air Filter Set..... A-5595-S
Air Filter Secondary..... A-5594
Fuel Filter..... FC-5517
Fuel/Water Separator Secondary.. SFC-5504-10
Fuel/Water Separator Secondary.. SFC-5504-10B
Hydraulic Oil Filter..... H-5522
Hydraulic Oil Filter..... HC-5516

365B II
(EXCAVATORS)
CAT S/N: 6A1-UP , 2004-UP
Air Filter Set..... A-5595-S
Air Filter Secondary..... A-5594
Air Filter Primary..... A-5593
Fuel Filter..... FC-5517
Fuel Filter..... FC-5509
Fuel/Water Separator Secondary.. SFC-5504-10B
Fuel/Water Separator Secondary.. SFC-5504-10
Hydraulic Oil Filter..... HC-55290
Hydraulic Oil Filter..... HC-55300
Hydraulic Oil Filter..... H-5522
Hydraulic Oil Filter..... HC-5516

365B II
(EXCAVATORS)
CAT S/N: DER1-UP , 2004-UP
Air Filter Secondary..... A-5594
Air Filter Set..... A-5595-S
Air Filter Primary..... A-5593
Fuel Filter..... FC-5509
Fuel Filter..... FC-5517
Fuel/Water Separator Secondary.. SFC-5504-10
Fuel/Water Separator Secondary.. SFC-5504-10B
Hydraulic Oil Filter..... HC-55290
Hydraulic Oil Filter..... HC-55300
Hydraulic Oil Filter..... H-7942
Hydraulic Oil Filter..... HC-5516
Hydraulic Oil Filter..... H-5522

365B II
(EXCAVATORS)
CAT S/N: GAR1-UP , 2004-UP
Air Filter Set..... A-5595-S
Air Filter Secondary..... A-5594
Air Filter Primary..... A-5593

MODEL/APPLICATION	SAKURA NO
-------------------	-----------

CATERPILLAR

Fuel Filter..... FC-5517
Fuel Filter..... FC-5509
Fuel/Water Separator Secondary.. SFC-5504-10
Fuel/Water Separator Secondary.. SFC-5504-10B
Hydraulic Oil Filter..... HC-55300
Hydraulic Oil Filter..... H-5522
Hydraulic Oil Filter..... HC-5516
Hydraulic Oil Filter..... H-7942
Hydraulic Oil Filter..... HC-55290

365B II
(EXCAVATORS)
CAT S/N: JMB1-UP , 2004-UP
Air Filter Primary..... A-5593
Air Filter Secondary..... A-5594
Air Filter Set..... A-5595-S
Fuel Filter..... FC-5509
Fuel Filter..... FC-5517
Fuel/Water Separator Secondary.. SFC-5504-10
Fuel/Water Separator Secondary.. SFC-5504-10B
Hydraulic Oil Filter..... HC-55290
Hydraulic Oil Filter..... HC-55300
Hydraulic Oil Filter..... H-7942
Hydraulic Oil Filter..... HC-5516
Hydraulic Oil Filter..... H-5522

365B II
(EXCAVATORS)
CAT S/N: PEG1-UP , 2004-UP
Air Filter Primary..... A-5593
Air Filter Set..... A-5595-S
Air Filter Secondary..... A-5594
Fuel Filter..... FC-5517
Fuel Filter..... FC-5509
Fuel/Water Separator Secondary.. SFC-5504-10B
Fuel/Water Separator Secondary.. SFC-5504-10
Hydraulic Oil Filter..... HC-55300
Hydraulic Oil Filter..... HC-55290
Hydraulic Oil Filter..... H-5522
Hydraulic Oil Filter..... HC-5516
Hydraulic Oil Filter..... H-7942

365B II
(EXCAVATORS)
CAT S/N: SDL1-UP , 2004-UP
Air Filter Secondary..... A-5594
Air Filter Set..... A-5595-S
Air Filter Primary..... A-5593
Fuel Filter..... FC-5509
Fuel Filter..... FC-5517
Fuel/Water Separator Secondary.. SFC-5504-10B
Fuel/Water Separator Secondary.. SFC-5504-10
Hydraulic Oil Filter..... HC-5516
Hydraulic Oil Filter..... H-5522
Hydraulic Oil Filter..... HC-55290
Hydraulic Oil Filter..... HC-55300

365BII
(EXCAVATORS)
CAT 3196 (S/N: 9PZ1-UP)
Air Filter Secondary..... A-5594
Air Filter Set..... A-5595-S
Air Filter Primary..... A-5593
Fuel Filter..... FC-5517
Fuel/Water Separator Secondary.. SFC-5504-10B
Fuel/Water Separator Secondary.. SFC-5504-10
Hydraulic Oil Filter..... H-7942

MODEL/APPLICATION	SAKURA NO
-------------------	-----------

CATERPILLAR

Hydraulic Oil Filter..... HC-5516
Oil Filter Full Flow..... C-5516

365BL
(EXCAVATORS)
CAT 3196 (S/N: AGD1-UP)
Air Filter Primary..... A-5593
Air Filter Set..... A-5595-S
Air Filter Secondary..... A-5594
Fuel Filter..... FC-5517
Fuel/Water Separator Secondary.. SFC-5504-10B
Fuel/Water Separator Secondary.. SFC-5504-10
Hydraulic Oil Filter..... HC-5516
Hydraulic Oil Filter..... H-7942
Oil Filter Full Flow..... C-5516

365C
(EXCAVATORS)
CAT (S/N: LHX1-UP)
Fuel Filter..... FC-5517

365C
(EXCAVATORS)
CAT C15 (S/N: ELC1-UP)
Air Filter Primary..... A-5593
Air Filter Set..... A-5595-S
Air Filter Secondary..... A-5594
Cabin Air Filter..... CA-55850
Fuel Filter..... FC-5510
Hydraulic Oil Filter..... H-5522
Hydraulic Oil Filter..... HC-5516
Hydraulic Oil Filter..... HC-55290
Hydraulic Oil Filter..... HC-55300

365C
(EXCAVATORS)
CAT C15 (S/N: FEN1-UP)
Air Filter Primary..... A-5593
Air Filter Secondary..... A-5594
Air Filter Set..... A-5595-S
Cabin Air Filter..... CA-55850
Fuel Filter..... FC-5510
Hydraulic Oil Filter..... HC-55300
Hydraulic Oil Filter..... HC-55290
Hydraulic Oil Filter..... HC-5516
Hydraulic Oil Filter..... H-5522

365C
(EXCAVATORS)
CAT C15 (S/N: GWC11-UP)
Air Filter Primary..... A-5593
Air Filter Set..... A-5595-S
Air Filter Secondary..... A-5594
Cabin Air Filter..... CA-55850
Fuel Filter..... FC-5510
Hydraulic Oil Filter..... H-5522
Hydraulic Oil Filter..... HC-5516
Hydraulic Oil Filter..... HC-55290
Hydraulic Oil Filter..... HC-55300

365C
(EXCAVATORS)
CAT C15 (S/N: MCS1-UP)
Air Filter Secondary..... A-5594
Air Filter Set..... A-5595-S
Air Filter Primary..... A-5593
Cabin Air Filter..... CA-55850
Fuel Filter..... FC-5510
Hydraulic Oil Filter..... HC-55300
Hydraulic Oil Filter..... HC-55290
Hydraulic Oil Filter..... HC-5516

Sakura Filter

ENGINE APPLICATION

MODEL/APPLICATION	SAKURA NO	MODEL/APPLICATION	SAKURA NO	MODEL/APPLICATION	SAKURA NO
CATERPILLAR		CATERPILLAR		CATERPILLAR	
365C (EXCAVATORS) CAT C15 (S/N: MCS1-UP) Hydraulic Oil Filter..... H-5522		375 (EXCAVATORS) CAT 3406 (S/N: 1JM1-UP) Air Filter Secondary..... A-5715 Fuel Filter..... F-5505 Fuel Filter..... FC-5509 Hydraulic Oil Filter..... H-5505 Hydraulic Oil Filter..... HC-5516 Oil Filter Full Flow..... C-5516		Hydraulic Oil Filter..... H-5505 Hydraulic Oil Filter..... HC-5516 Oil Filter Full Flow..... C-5516	
365C (EXCAVATORS) CAT C15 (S/N: MCY1-UP) Air Filter Set..... A-5595-S Air Filter Secondary..... A-5594 Air Filter Primary..... A-5593 Cabin Air Filter..... CA-55850 Fuel Filter..... FC-5510 Hydraulic Oil Filter..... H-5522 Hydraulic Oil Filter..... HC-5516 Hydraulic Oil Filter..... HC-55290 Hydraulic Oil Filter..... HC-55300		375 (EXCAVATORS) CAT 3406 (S/N: 6NK1-UP) Air Filter Secondary..... A-5715 Fuel Filter..... FC-5509 Fuel Filter..... F-5505 Hydraulic Oil Filter..... HC-5516 Hydraulic Oil Filter..... H-5505 Oil Filter Full Flow..... C-5516		375 (EXCAVATORS) S/N: 8XG313-UP Air Filter Secondary..... A-5630 Air Filter Set..... A-5629-S Air Filter Primary..... A-5629 Fuel Filter..... FC-5509 Fuel Filter..... F-5505 Hydraulic Oil Filter..... HC-5516 Hydraulic Oil Filter..... H-5505 Hydraulic Oil Filter..... HC-55300 Hydraulic Oil Filter..... HC-55200 Oil Filter Full Flow..... C-5516	
365C (EXCAVATORS) CAT C15 (S/N: MEM1-UP) Air Filter Primary..... A-5593 Air Filter Secondary..... A-5594 Air Filter Set..... A-5595-S Cabin Air Filter..... CA-55850 Fuel Filter..... FC-5510 Hydraulic Oil Filter..... HC-55300 Hydraulic Oil Filter..... HC-55290 Hydraulic Oil Filter..... HC-5516 Hydraulic Oil Filter..... H-5522		375 (EXCAVATORS) CAT 3406 (S/N: 6RL1-UP) Air Filter Secondary..... A-5715 Air Filter Primary..... A-5629 Air Filter Set..... A-5629-S Air Filter Secondary..... A-5630 Fuel Filter..... F-5505 Fuel Filter..... FC-5509 Hydraulic Oil Filter..... H-5505 Hydraulic Oil Filter..... HC-5516 Oil Filter Full Flow..... C-5516		375L (EXCAVATORS) CAT 3406 (S/N: 11N01-UP) Air Filter Secondary..... A-5715 Coolant Filter..... WC-5705 Coolant Filter..... WC-5707 Fuel Filter..... F-5505 Fuel Filter..... FC-5509 Hydraulic Oil Filter..... H-5505 Oil Filter Full Flow..... C-5516	
365C (EXCAVATORS) CAT C15 (S/N: PAR2-UP) Air Filter Primary..... A-5593 Air Filter Set..... A-5595-S Air Filter Secondary..... A-5594 Cabin Air Filter..... CA-55850 Fuel Filter..... FC-5510 Hydraulic Oil Filter..... H-5522 Hydraulic Oil Filter..... HC-5516 Hydraulic Oil Filter..... HC-55290 Hydraulic Oil Filter..... HC-55300		375 (EXCAVATORS) CAT 3406 (S/N: 8WJ1-UP) Air Filter Set..... A-5629-S Air Filter Primary..... A-5629 Air Filter Secondary..... A-5715 Fuel Filter..... FC-5509 Fuel Filter..... F-5505 Hydraulic Oil Filter..... HC-5516 Hydraulic Oil Filter..... H-5505		375L (EXCAVATORS) CAT 3406 (S/N: 6RL1-UP) Air Filter Primary..... A-5629 Air Filter Set..... A-5629-S Air Filter Secondary..... A-5715 Air Filter Secondary..... A-5630 Fuel Filter..... F-5505 Fuel Filter..... FC-5509 Hydraulic Oil Filter..... H-5505 Oil Filter Full Flow..... C-5516	
365C (EXCAVATORS) S/N: GWC1-10-UP Air Filter Primary..... A-5593 Air Filter Secondary..... A-5594 Air Filter Set..... A-5595-S Cabin Air Filter..... CA-55850 Fuel Filter..... FC-5510 Hydraulic Oil Filter..... HC-55300 Hydraulic Oil Filter..... HC-55290 Hydraulic Oil Filter..... HC-5516 Hydraulic Oil Filter..... H-5522		375 (EXCAVATORS) CAT 3406 (S/N: 8XG1-313-UP) Air Filter Secondary..... A-5715 Fuel Filter..... F-5505 Fuel Filter..... FC-5509 Hydraulic Oil Filter..... H-5505 Hydraulic Oil Filter..... HC-5516 Oil Filter Full Flow..... C-5516		375L (EXCAVATORS) CAT 3406 (S/N: 8WJ1-UP) Air Filter Secondary..... A-5630 Air Filter Set..... A-5629-S Air Filter Primary..... A-5629 Fuel Filter..... FC-5509 Fuel Filter..... F-5505 Hydraulic Oil Filter..... HC-5516 Hydraulic Oil Filter..... H-5505	
365C (EXCAVATORS) S/N: PARI-1-UP Air Filter Set..... A-5595-S Air Filter Secondary..... A-5594 Air Filter Primary..... A-5593 Cabin Air Filter..... CA-55850 Hydraulic Oil Filter..... H-5522 Hydraulic Oil Filter..... HC-5516 Hydraulic Oil Filter..... HC-55290 Hydraulic Oil Filter..... HC-55300		375 (EXCAVATORS) CAT 3406 (S/N: 9WL1-UP) Air Filter Secondary..... A-5715 Fuel Filter..... F-5505 Fuel Filter..... FC-5509		375L (EXCAVATORS) CAT 3406 (S/N: 8WJ771-UP) Air Filter Secondary..... A-5715 Coolant Filter..... WC-5705 Coolant Filter..... WC-5707 Fuel Filter..... FC-5509	

MODEL/APPLICATION	SAKURA NO
CATERPILLAR	
375L (EXCAVATORS) CAT 3406 (S/N: 8WJ771-UP)	
Fuel Filter.....	F-5505
Hydraulic Oil Filter.....	H-5505
Oil Filter Full Flow.....	C-5516
375L (EXCAVATORS) S/N: 8HK1-UP	
Air Filter Secondary.....	A-5630
Hydraulic Oil Filter.....	HC-55200
Hydraulic Oil Filter.....	H-5505
Oil Filter Full Flow.....	C-5516
375L (EXCAVATORS) S/N: 9FL1-UP	
Air Filter Secondary.....	A-5630
Hydraulic Oil Filter.....	H-5505
Hydraulic Oil Filter.....	HC-55200
Oil Filter Full Flow.....	C-5516
385B (EXCAVATORS) CAT 3456 (S/N: ANS1-UP)	
Air Filter Secondary.....	A-5594
Air Filter Set.....	A-5595-S
Air Filter Primary.....	A-5593
Fuel Filter.....	FC-5517
Fuel/Water Separator Secondary..	SFC-5504-10
Fuel/Water Separator Secondary..	SFC-5504-10B
Hydraulic Oil Filter.....	HC-5516
Hydraulic Oil Filter.....	H-7942
Oil Filter Full Flow.....	C-5516
385B (EXCAVATORS) CAT 3456 (S/N: BFK1-UP)	
Air Filter Primary.....	A-5593
Air Filter Set.....	A-5595-S
Air Filter Secondary.....	A-5594
Cabin Air Filter.....	CA-55850
Fuel Filter.....	FC-5517
Fuel/Water Separator Secondary..	SFC-5504-10B
Fuel/Water Separator Secondary..	SFC-5504-10
Hydraulic Oil Filter.....	H-5522
Hydraulic Oil Filter.....	H-7942
Hydraulic Oil Filter.....	HC-5516
385B (EXCAVATORS) CAT 3456 (S/N: BLY1-UP)	
Air Filter Secondary.....	A-5594
Air Filter Set.....	A-5595-S
Air Filter Primary.....	A-5593
Cabin Air Filter.....	CA-55850
Fuel Filter.....	FC-5517
Fuel/Water Separator Secondary..	SFC-5504-10
Fuel/Water Separator Secondary..	SFC-5504-10B
Hydraulic Oil Filter.....	HC-5516
Hydraulic Oil Filter.....	H-7942
Hydraulic Oil Filter.....	H-5522
385B (EXCAVATORS) CAT 3456 (S/N: MVA1-UP)	
Air Filter Secondary.....	A-5594
Air Filter Set.....	A-5595-S
Air Filter Primary.....	A-5593
Fuel Filter.....	FC-5517
Fuel/Water Separator Secondary..	SFC-5504-10B
Fuel/Water Separator Secondary..	SFC-5504-10
Hydraulic Oil Filter.....	HC-5516
Hydraulic Oil Filter.....	H-7942
Hydraulic Oil Filter.....	H-5522
Oil Filter Full Flow.....	C-5516

MODEL/APPLICATION	SAKURA NO
CATERPILLAR	
Fuel/Water Separator Secondary..	SFC-5504-10B
Fuel/Water Separator Secondary..	SFC-5504-10
Hydraulic Oil Filter.....	H-7942
385B (EXCAVATORS) CAT 3456 (S/N: CLS1-UP)	
Air Filter Secondary.....	A-5594
Air Filter Set.....	A-5595-S
Air Filter Primary.....	A-5593
Fuel Filter.....	FC-5517
Fuel/Water Separator Secondary..	SFC-5504-10
Fuel/Water Separator Secondary..	SFC-5504-10B
Hydraulic Oil Filter.....	H-7942
Hydraulic Oil Filter.....	HC-5516
Hydraulic Oil Filter.....	H-5522
Oil Filter Full Flow.....	C-5516
385B (EXCAVATORS) CAT 3456 (S/N: CLS215-UP)	
Air Filter Primary.....	A-5593
Air Filter Set.....	A-5595-S
Air Filter Secondary.....	A-5594
Fuel Filter.....	FC-5517
Fuel/Water Separator Secondary..	SFC-5504-10B
Fuel/Water Separator Secondary..	SFC-5504-10
Hydraulic Oil Filter.....	HC-5516
Hydraulic Oil Filter.....	H-7942
Hydraulic Oil Filter.....	H-5522
Oil Filter Full Flow.....	C-5516
385B (EXCAVATORS) CAT 3456 (S/N: FDL161-UP)	
Air Filter Secondary.....	A-5594
Air Filter Set.....	A-5595-S
Air Filter Primary.....	A-5593
Fuel Filter.....	FC-5517
Fuel/Water Separator Secondary..	SFC-5504-10
Fuel/Water Separator Secondary..	SFC-5504-10B
Hydraulic Oil Filter.....	H-7942
Hydraulic Oil Filter.....	HC-5516
Hydraulic Oil Filter.....	H-5522
Oil Filter Full Flow.....	C-5516
385B (EXCAVATORS) CAT 3456 (S/N: FDL1-UP)	
Air Filter Primary.....	A-5593
Air Filter Set.....	A-5595-S
Air Filter Secondary.....	A-5594
Fuel Filter.....	FC-5517
Fuel/Water Separator Secondary..	SFC-5504-10B
Fuel/Water Separator Secondary..	SFC-5504-10
Hydraulic Oil Filter.....	HC-5516
Hydraulic Oil Filter.....	H-7942
Hydraulic Oil Filter.....	H-5522
Oil Filter Full Flow.....	C-5516
385B (EXCAVATORS) CAT 3456 (S/N: MYA1-UP)	
Air Filter Secondary.....	A-5594
Air Filter Set.....	A-5595-S
Air Filter Primary.....	A-5593
Fuel Filter.....	FC-5517
Fuel/Water Separator Secondary..	SFC-5504-10
Fuel/Water Separator Secondary..	SFC-5504-10B

MODEL/APPLICATION	SAKURA NO
CATERPILLAR	
Hydraulic Oil Filter.....	H-7942
Hydraulic Oil Filter.....	HC-5516
385B (EXCAVATORS) CAT 3456 (S/N: RCD1-UP)	
Air Filter Primary.....	A-5593
Air Filter Set.....	A-5595-S
Air Filter Secondary.....	A-5594
Fuel Filter.....	FC-5517
Fuel/Water Separator Secondary..	SFC-5504-10B
Fuel/Water Separator Secondary..	SFC-5504-10
Hydraulic Oil Filter.....	H-5522
Hydraulic Oil Filter.....	HC-5516
Hydraulic Oil Filter.....	H-7942
385BL (EXCAVATORS) CAT 3456 (S/N: ANS1-UP)	
Air Filter Primary.....	A-5593
Air Filter Set.....	A-5595-S
Air Filter Secondary.....	A-5594
Fuel Filter.....	FC-5517
Fuel/Water Separator Secondary..	SFC-5504-10B
Fuel/Water Separator Secondary..	SFC-5504-10
Hydraulic Oil Filter.....	H-7942
385BL (EXCAVATORS) CAT 3456 (S/N: CKB1-UP)	
Air Filter Secondary.....	A-5594
Air Filter Set.....	A-5595-S
Air Filter Primary.....	A-5593
Fuel Filter.....	FC-5517
Fuel/Water Separator Secondary..	SFC-5504-10B
Fuel/Water Separator Secondary..	SFC-5504-10
Hydraulic Oil Filter.....	H-7942
385BL (EXCAVATORS) CAT 3456 (S/N: CLS1-UP)	
Air Filter Primary.....	A-5593
Air Filter Set.....	A-5595-S
Air Filter Secondary.....	A-5594
Fuel Filter.....	FC-5517
Fuel/Water Separator Secondary..	SFC-5504-10
Fuel/Water Separator Secondary..	SFC-5504-10B
Hydraulic Oil Filter.....	HC-5516
385BL (EXCAVATORS) CAT 3456 (S/N: FDL1-UP)	
Air Filter Secondary.....	A-5594
Air Filter Set.....	A-5595-S
Air Filter Primary.....	A-5593
Fuel Filter.....	FC-5517
Fuel/Water Separator Secondary..	SFC-5504-10B
Fuel/Water Separator Secondary..	SFC-5504-10
385C (EXCAVATORS) 2007-UP	
Air Filter Secondary.....	A-5594
Air Filter Set.....	A-5595-S
Air Filter Primary.....	A-5593
Fuel Filter.....	FC-5517
Hydraulic Oil Filter.....	HC-55290
Hydraulic Oil Filter.....	HC-5503
385C (EXCAVATORS) CAT C18 ACERT	

Sakura Filter

ENGINE APPLICATION

MODEL/APPLICATION	SAKURA NO	MODEL/APPLICATION	SAKURA NO	MODEL/APPLICATION	SAKURA NO
CATERPILLAR					
385C (EXCAVATORS) CAT C18 ACERT		416B (BACKHOE LOADERS) S/N: 85G-UP		416D (BACKHOE LOADERS) CAT 3054C DIT	
Hydraulic Oil Filter.....	HC-9901	Air Filter Set.....	A-5579-S	Hydraulic Oil Filter Transmission....	HC-5501
385CL (EXCAVATORS) CAT C18 ACERT		Air Filter Set.....	A-5578-S	Oil Filter Full Flow.....	C-5101
Hydraulic Oil Filter.....	H-5507	Air Filter Primary.....	A-5577	416E (BACKHOE LOADERS) S/N: BWC1-UP , 2011	
414E (BACKHOE LOADERS) CAT 3054		Air Filter Secondary.....	A-5580	Cabin Air Filter.....	CA-44360
Cabin Air Filter.....	CA-55110	Fuel Filter.....	FS-5701	Hydraulic Oil Filter.....	HC-5512
414E (BACKHOE LOADERS) CAT (S/N: CRS1-UP)		Hydraulic Oil Filter.....	HC-5503	Oil Filter Full Flow.....	C-5102
Oil Filter Full Flow.....	C-5102	Oil Filter Full Flow.....	C-5102	416E (BACKHOE LOADERS) S/N: CBD 5745-UP , 2011	
414E (BACKHOE LOADERS) CAT (S/N: G4D1-UP)		416B (BACKHOE LOADERS) S/N: 8ZK1-5999		Cabin Air Filter.....	CA-44360
Oil Filter Full Flow.....	C-5102	Air Filter Secondary.....	A-5580	Oil Filter Full Flow.....	C-5102
414E (BACKHOE LOADERS) S/N: ELB1-UP		Air Filter Primary.....	A-5577	416E (BACKHOE LOADERS) S/N: CBD1-5744 , 2011	
Cabin Air Filter.....	CA-44360	Air Filter Set.....	A-5578-S	Cabin Air Filter.....	CA-44360
Hydraulic Oil Filter.....	HC-5512	Air Filter Set.....	A-5579-S	Hydraulic Oil Filter.....	HC-5512
Oil Filter Full Flow.....	C-5102	Hydraulic Oil Filter.....	HC-5512	Oil Filter Full Flow.....	C-5102
414E IL (BACKHOE LOADERS) CAT 3054		Hydraulic Oil Filter.....	HC-5506	416E (BACKHOE LOADERS) S/N: LMS1-UP , 2011	
Cabin Air Filter.....	CA-55110	Oil Filter Full Flow.....	C-5102	Cabin Air Filter.....	CA-44360
415F2 (BACKHOE LOADERS) CAT C3.4		Oil Filter Full Flow.....	C-5102	Hydraulic Oil Filter.....	HC-5512
Cabin Air Filter.....	CA-55110	416B (BACKHOE LOADERS) S/N: 8ZK6000-UP		Oil Filter Full Flow.....	C-5102
416 (BACKHOE LOADERS) S/N: 5PC1-10761		Air Filter Set.....	A-5579-S	416E (BACKHOE LOADERS) S/N: SHA1-UP , 2011	
Air Filter Primary.....	A-5577	Air Filter Set.....	A-5578-S	Cabin Air Filter.....	CA-44360
Air Filter Set.....	A-5578-S	Air Filter Primary.....	A-5577	Hydraulic Oil Filter.....	HC-5512
Air Filter Set.....	A-5579-S	Air Filter Secondary.....	A-5580	Oil Filter Full Flow.....	C-5102
Hydraulic Oil Filter.....	H-5510	Hydraulic Oil Filter.....	HC-5506	416E (BACKHOE LOADERS) C4.4	
Hydraulic Oil Filter.....	H-5506	Hydraulic Oil Filter.....	HC-5512	Cabin Air Filter.....	CA-44360
Oil Filter Full Flow.....	C-5101	Oil Filter Full Flow.....	C-5102	Fuel Filter.....	FS-5701
416B (BACKHOE LOADERS) S/N: 85G1-11999		Oil Filter Full Flow.....	C-5101	Hydraulic Oil Filter.....	HC-5512
Air Filter Secondary.....	A-5580	416D (BACKHOE LOADERS) CAT 3054B (S/N: BFP1-UP)		Oil Filter Full Flow.....	C-5102
Air Filter Primary.....	A-5577	Air Filter Secondary.....	A-5540	416E (BACKHOE LOADERS) CAT (S/N: CRS1-UP)	
Air Filter Set.....	A-5578-S	Air Filter Primary.....	A-5541	Oil Filter Full Flow.....	C-5102
Air Filter Set.....	A-5579-S	Air Filter Primary.....	A-5541M	416E (BACKHOE LOADERS) CAT (S/N: G4D1-UP)	
Hydraulic Oil Filter.....	H-5510	Air Filter Set.....	A-5541M-S	Oil Filter Full Flow.....	C-5102
Hydraulic Oil Filter.....	H-5506	Air Filter Primary.....	A-76231	416E (BACKHOE LOADERS) S/N: 85G1-11999	
Oil Filter Full Flow.....	C-5101	Hydraulic Oil Filter.....	HC-5512	Air Filter Set.....	A-5579-S
416B (BACKHOE LOADERS) S/N: 85G1-11999		Oil Filter Full Flow.....	C-5102	Air Filter Primary.....	A-5577
Air Filter Set.....	A-5579-S	416D (BACKHOE LOADERS) CAT 3054B (S/N: BGJ1-UP)		Air Filter Set.....	A-5578-S
Air Filter Set.....	A-5578-S	Air Filter Primary.....	A-76231	Oil Filter Full Flow.....	C-5102
Air Filter Primary.....	A-5577	Air Filter Set.....	A-5541M-S	416E (BACKHOE LOADERS) S/N: 85G1-11999	
Air Filter Secondary.....	A-5580	Air Filter Primary.....	A-5541M	Air Filter Secondary.....	A-5580
Fuel Filter.....	FS-5701	Air Filter Primary.....	A-5541	Air Filter Primary.....	A-5577
Hydraulic Oil Filter.....	HC-5512	Air Filter Secondary.....	A-5540	Air Filter Set.....	A-5578-S
Hydraulic Oil Filter.....	HC-5503	Hydraulic Oil Filter.....	HC-5512	Air Filter Set.....	A-5579-S
Oil Filter Full Flow.....	C-5102	Oil Filter Full Flow.....	C-5102	Fuel Filter.....	FS-5701
Oil Filter Full Flow.....	C-5101	416D (BACKHOE LOADERS) CAT 3054B (S/N: BKG1-UP)		416B TURBO (BACKHOE LOADERS) S/N: 85G1-UP	
416B (BACKHOE LOADERS) S/N: 85G12000-UP		Air Filter Primary.....	A-76231	Air Filter Secondary.....	A-5580
Air Filter Secondary.....	A-5580	Air Filter Set.....	A-5541M-S	Air Filter Primary.....	A-5577
Air Filter Primary.....	A-5577	Air Filter Primary.....	A-5541M	Air Filter Set.....	A-5578-S
Air Filter Set.....	A-5578-S	Air Filter Primary.....	A-5541	Air Filter Set.....	A-5579-S
Air Filter Set.....	A-5579-S	Air Filter Secondary.....	A-5540	Fuel Filter.....	FS-5701
Hydraulic Oil Filter.....	HC-5506	Hydraulic Oil Filter.....	HC-5512	416E (BACKHOE LOADERS) S/N: CBD1-UP	
Hydraulic Oil Filter.....	HC-5503	Oil Filter Full Flow.....	C-5102	Hydraulic Oil Filter.....	HC-5512
Hydraulic Oil Filter.....	HC-5512	416D (BACKHOE LOADERS) CAT 3054B (S/N: BKG1-UP)		416B TURBO (BACKHOE LOADERS) S/N: 85G1-UP	
Oil Filter Full Flow.....	C-5102	Air Filter Secondary.....	A-5540	Air Filter Secondary.....	A-5580
Oil Filter Full Flow.....	C-5101	Air Filter Primary.....	A-5541	Air Filter Primary.....	A-5577
		Air Filter Primary.....	A-5541M	Air Filter Set.....	A-5578-S
		Air Filter Set.....	A-5541M-S	Air Filter Set.....	A-5579-S
		Air Filter Primary.....	A-76231	Fuel Filter.....	FS-5701
		Hydraulic Oil Filter.....	HC-5512		
		Oil Filter Full Flow.....	C-5102		

MODEL/APPLICATION	SAKURA NO	MODEL/APPLICATION	SAKURA NO	MODEL/APPLICATION	SAKURA NO
CATERPILLAR		CATERPILLAR		CATERPILLAR	
416B TURBO (BACKHOE LOADERS) S/N: 85G1-UP Hydraulic Oil Filter..... HC-5503 Oil Filter Full Flow..... C-5101		Air Filter Primary..... A-5541 Air Filter Primary..... A-5541M Air Filter Set..... A-5541M-S Hydraulic Oil Filter..... HC-5512 Hydraulic Oil Filter Transmission... HC-5501 Oil Filter Full Flow..... C-5102		Air Filter Primary..... A-5541M Air Filter Primary..... A-5541 Air Filter Secondary..... A-5540 Air Filter Primary..... A-76231 Hydraulic Oil Filter..... HC-5512 Hydraulic Oil Filter..... HC-5506 Oil Filter Full Flow..... C-5102 Oil Filter Full Flow..... C-5101	
416C (BACKHOE LOADERS) CAT 3054T (S/N: 1WR8116-UP) Air Filter Set..... A-5541M-S Air Filter Primary..... A-5541M Air Filter Primary..... A-5541 Air Filter Secondary..... A-5540 Air Filter Primary..... A-76231 Hydraulic Oil Filter Transmission... HC-5501 Hydraulic Oil Filter..... HC-5512 Oil Filter Full Flow..... C-5102		416C (BACKHOE LOADERS) CAT 3054T (S/N: BKG1-UP) Air Filter Set..... A-5541M-S Air Filter Primary..... A-5541M Air Filter Primary..... A-5541 Air Filter Secondary..... A-5540 Air Filter Primary..... A-76231 Hydraulic Oil Filter Transmission... HC-5501 Hydraulic Oil Filter..... HC-5512 Oil Filter Full Flow..... C-5102		416C (BACKHOE LOADERS) S/N: 1CR-UP Air Filter Primary..... A-76231 Air Filter Secondary..... A-5540 Air Filter Primary..... A-5541 Air Filter Primary..... A-5541M Air Filter Set..... A-5541M-S Hydraulic Oil Filter..... HC-5506 Hydraulic Oil Filter..... HC-5503 Hydraulic Oil Filter..... HC-5512 Oil Filter Full Flow..... C-5101 Oil Filter Full Flow..... C-5102	
416C (BACKHOE LOADERS) CAT 3054T (S/N: 1XR2184-2249) Air Filter Primary..... A-76231 Air Filter Secondary..... A-5540 Air Filter Primary..... A-5541 Air Filter Primary..... A-5541M Air Filter Set..... A-5541M-S Hydraulic Oil Filter..... HC-5512 Hydraulic Oil Filter Transmission... HC-5501 Oil Filter Full Flow..... C-5102		416C (BACKHOE LOADERS) CAT 7B11-UP Air Filter Set..... A-56731-S Air Filter Secondary..... A-56741 Air Filter Primary..... A-56731		416C (BACKHOE LOADERS) S/N: 1KR1-UP Air Filter Primary..... A-76231 Air Filter Secondary..... A-5540 Air Filter Primary..... A-5541 Air Filter Primary..... A-5541M Air Filter Set..... A-5541M-S Hydraulic Oil Filter..... HC-5506 Hydraulic Oil Filter..... HC-5512 Oil Filter Full Flow..... C-5101 Oil Filter Full Flow..... C-5102	
416C (BACKHOE LOADERS) CAT 3054T (S/N: 4ZN16004-UP) Air Filter Set..... A-5541M-S Air Filter Primary..... A-5541M Air Filter Primary..... A-5541 Air Filter Secondary..... A-5540 Air Filter Primary..... A-76231 Hydraulic Oil Filter Transmission... HC-5501 Hydraulic Oil Filter..... HC-5512 Oil Filter Full Flow..... C-5102		416C (BACKHOE LOADERS) S/N: 1AR-UP Air Filter Primary..... A-76231 Air Filter Secondary..... A-5540 Air Filter Primary..... A-5541 Air Filter Primary..... A-5541M Air Filter Set..... A-5541M-S Hydraulic Oil Filter..... HC-5506 Hydraulic Oil Filter..... HC-5512 Oil Filter Full Flow..... C-5101 Oil Filter Full Flow..... C-5102		416C (BACKHOE LOADERS) S/N: 1LR1-UP Air Filter Set..... A-5541M-S Air Filter Primary..... A-5541M Air Filter Primary..... A-5541 Air Filter Secondary..... A-5540 Air Filter Primary..... A-76231 Air Filter Primary..... A-5541M-S Hydraulic Oil Filter..... HC-5506 Hydraulic Oil Filter..... HC-5512 Hydraulic Oil Filter..... HC-5506 Oil Filter Full Flow..... C-5102 Oil Filter Full Flow..... C-5101	
416C (BACKHOE LOADERS) CAT 3054T (S/N: 5YN15148-UP) Air Filter Primary..... A-76231 Air Filter Secondary..... A-5540 Air Filter Primary..... A-5541 Air Filter Primary..... A-5541M Air Filter Set..... A-5541M-S Hydraulic Oil Filter..... HC-5512 Hydraulic Oil Filter Transmission... HC-5501 Oil Filter Full Flow..... C-5102		416C (BACKHOE LOADERS) S/N: 1BR1-UP Air Filter Set..... A-5541M-S Air Filter Primary..... A-5541M Air Filter Primary..... A-5541 Air Filter Secondary..... A-5540 Air Filter Primary..... A-5541 Air Filter Primary..... A-5541M Air Filter Set..... A-5541M-S Hydraulic Oil Filter..... HC-5506 Hydraulic Oil Filter..... HC-5503 Hydraulic Oil Filter..... HC-5512 Oil Filter Full Flow..... C-5102 Oil Filter Full Flow..... C-5101		416C (BACKHOE LOADERS) S/N: 1WR1-8115 Air Filter Set..... A-5541M-S Air Filter Primary..... A-5541M Air Filter Primary..... A-5541 Air Filter Secondary..... A-5540 Air Filter Primary..... A-76231 Hydraulic Oil Filter..... HC-5512 Hydraulic Oil Filter..... HC-5506 Oil Filter Full Flow..... C-5102 Oil Filter Full Flow..... C-5101	
416C (BACKHOE LOADERS) CAT 3054T (S/N: BFP1-UP) Air Filter Set..... A-5541M-S Air Filter Primary..... A-5541M Air Filter Primary..... A-5541 Air Filter Secondary..... A-5540 Air Filter Primary..... A-76231 Hydraulic Oil Filter Transmission... HC-5501 Hydraulic Oil Filter..... HC-5512 Oil Filter Full Flow..... C-5102		416C (BACKHOE LOADERS) S/N: 1BR-UP Air Filter Set..... A-5541M-S		416C (BACKHOE LOADERS) S/N: 1WR-UP Air Filter Primary..... A-76231 Air Filter Secondary..... A-5540	
416C (BACKHOE LOADERS) CAT 3054T (S/N: BGG1-UP) Air Filter Primary..... A-76231 Air Filter Secondary..... A-5540		416C (BACKHOE LOADERS) S/N: 1BR-UP Air Filter Set..... A-5541M-S		416C (BACKHOE LOADERS) S/N: 1WR-UP Air Filter Primary..... A-76231 Air Filter Secondary..... A-5540	

MODEL/APPLICATION	SAKURA NO	MODEL/APPLICATION	SAKURA NO	MODEL/APPLICATION	SAKURA NO
CATERPILLAR		CATERPILLAR		CATERPILLAR	
416C (BACKHOE LOADERS) S/N: 1WR-UP Air Filter Primary..... A-5541 Air Filter Primary..... A-5541M Air Filter Set..... A-5541M-S Hydraulic Oil Filter..... HC-5506 Hydraulic Oil Filter..... HC-5512 Hydraulic Oil Filter..... HC-5503 Oil Filter Full Flow..... C-5101 Oil Filter Full Flow..... C-5102		Air Filter Set..... A-5541M-S Air Filter Primary..... A-5541M Air Filter Primary..... A-5541 Air Filter Secondary..... A-5540 Air Filter Primary..... A-76231 Hydraulic Oil Filter..... HC-5512 Hydraulic Oil Filter..... HC-5503 Hydraulic Oil Filter..... HC-5506 Oil Filter Full Flow..... C-5102 Oil Filter Full Flow..... C-5101		420E (BACKHOE LOADERS) S/N: GAN1-UP , 2011 Cabin Air Filter..... CA-44360 Hydraulic Oil Filter..... HC-5512 Oil Filter Full Flow..... C-5102 420E (BACKHOE LOADERS) S/N: GEK1-UP , 2011 Cabin Air Filter..... CA-44360 Hydraulic Oil Filter..... HC-5512 Oil Filter Full Flow..... C-5102 420E (BACKHOE LOADERS) S/N: HLS1-UP , 2011 Cabin Air Filter..... CA-44360 Hydraulic Oil Filter..... HC-5512 Oil Filter Full Flow..... C-5102 420E (BACKHOE LOADERS) S/N: KMW1-UP , 2011 Cabin Air Filter..... CA-44360 Hydraulic Oil Filter..... HC-5512 Oil Filter Full Flow..... C-5102 420E (BACKHOE LOADERS) S/N: PRA1-UP , 2011 Cabin Air Filter..... CA-44360 Hydraulic Oil Filter..... HC-5512 Oil Filter Full Flow..... C-5102	
416C (BACKHOE LOADERS) S/N: 1XR1-2183 Air Filter Set..... A-5541M-S Air Filter Primary..... A-5541M Air Filter Primary..... A-5541 Air Filter Secondary..... A-5540 Air Filter Primary..... A-76231 Hydraulic Oil Filter..... HC-5503 Hydraulic Oil Filter..... HC-5512 Hydraulic Oil Filter..... HC-5506 Oil Filter Full Flow..... C-5102 Oil Filter Full Flow..... C-5101		416C (BACKHOE LOADERS) S/N: 5YN1-15147 Air Filter Primary..... A-76231 Air Filter Secondary..... A-5540 Air Filter Primary..... A-5541 Air Filter Primary..... A-5541M Air Filter Set..... A-5541M-S Hydraulic Oil Filter..... HC-5506 Hydraulic Oil Filter..... HC-5503 Hydraulic Oil Filter..... HC-5512 Oil Filter Full Flow..... C-5101 Oil Filter Full Flow..... C-5102		420E (BACKHOE LOADERS) S/N: MMS1-UP , 2011 Cabin Air Filter..... CA-44360 Hydraulic Oil Filter..... HC-5512 Oil Filter Full Flow..... C-5102	
416C (BACKHOE LOADERS) S/N: 1XR2250-UP Air Filter Primary..... A-76231 Air Filter Secondary..... A-5540 Air Filter Primary..... A-5541 Air Filter Primary..... A-5541M Air Filter Set..... A-5541M-S Hydraulic Oil Filter..... HC-5506 Hydraulic Oil Filter..... HC-5512 Oil Filter Full Flow..... C-5101 Oil Filter Full Flow..... C-5102		416C (BACKHOE LOADERS) S/N: 5YN-UP Air Filter Set..... A-5541M-S Air Filter Primary..... A-5541M Air Filter Primary..... A-5541 Air Filter Secondary..... A-5540 Air Filter Primary..... A-76231 Hydraulic Oil Filter..... HC-5512 Hydraulic Oil Filter..... HC-5503 Hydraulic Oil Filter..... HC-5506 Oil Filter Full Flow..... C-5102 Oil Filter Full Flow..... C-5101		420E (BACKHOE LOADERS) S/N: PHC1-UP Cabin Air Filter..... CA-44360 Fuel Filter..... FS-5701 Fuel Filter..... FC-51170 Hydraulic Oil Filter..... HC-5512 Oil Filter Full Flow..... C-5102	
416C (BACKHOE LOADERS) S/N: 1XR-UP Air Filter Set..... A-5541M-S Air Filter Primary..... A-5541M Air Filter Primary..... A-5541 Air Filter Secondary..... A-5540 Air Filter Primary..... A-76231 Hydraulic Oil Filter..... HC-5512 Hydraulic Oil Filter..... HC-5503 Hydraulic Oil Filter..... HC-5506 Oil Filter Full Flow..... C-5102 Oil Filter Full Flow..... C-5101		416F2 (BACKHOE LOADERS) C4.4 ACERT , 2015 Cabin Air Filter..... CA-44360 Fuel Filter..... FS-5701 Oil Filter Full Flow..... C-5102		420E (BACKHOE LOADERS) CAT C4.4 Cabin Air Filter..... CA-55110 420E (BACKHOE LOADERS) CAT 3054C Cabin Air Filter..... CA-55110 420E (BACKHOE LOADERS) S/N: PHC1-UP Cabin Air Filter..... CA-44360 Fuel Filter..... FC-51170 Hydraulic Oil Filter..... HC-5512 Oil Filter Full Flow..... C-5102	
416C (BACKHOE LOADERS) S/N: 4ZN1-16043 Air Filter Primary..... A-76231 Air Filter Secondary..... A-5540 Air Filter Primary..... A-5541 Air Filter Primary..... A-5541M Air Filter Set..... A-5541M-S Hydraulic Oil Filter..... HC-5506 Hydraulic Oil Filter..... HC-5512 Oil Filter Full Flow..... C-5101 Oil Filter Full Flow..... C-5102		420D (BACKHOE LOADERS) CAT 7B31-UP Air Filter Primary..... A-56731 Air Filter Secondary..... A-56741 Air Filter Set..... A-56731-S		420E (BACKHOE LOADERS) S/N: DAN1-UP , 2011 Cabin Air Filter..... CA-44360 Hydraulic Oil Filter..... HC-5512 Oil Filter Full Flow..... C-5102	
416C (BACKHOE LOADERS) S/N: 4ZN-UP Air Filter Primary..... A-76231 Air Filter Secondary..... A-5540 Air Filter Primary..... A-5541 Air Filter Primary..... A-5541M Air Filter Set..... A-5541M-S Hydraulic Oil Filter..... HC-5506 Hydraulic Oil Filter..... HC-5512 Oil Filter Full Flow..... C-5101 Oil Filter Full Flow..... C-5102		420E (BACKHOE LOADERS) S/N: DJL1-UP , 2011 Cabin Air Filter..... CA-44360 Hydraulic Oil Filter..... HC-5512 Oil Filter Full Flow..... C-5102		420F2 (BACKHOE LOADERS) 3054C Cabin Air Filter..... CA-55110 422E (BACKHOE LOADERS) 3054C Cabin Air Filter..... CA-55110 422E (BACKHOE LOADERS) CAT C4.4 Cabin Air Filter..... CA-55110 422E (BACKHOE LOADERS) CAT S/N: CRS1-UP	

MODEL/APPLICATION	SAKURA NO
CATERPILLAR	
426C (BACKHOE LOADERS) S/N: 1NR1050-UP	
Air Filter Set.....	A-5541M-S
Air Filter Primary.....	A-5541M
Air Filter Primary.....	A-5541
Air Filter Secondary.....	A-5540
Air Filter Primary.....	A-76231
Hydraulic Oil Filter.....	HC-5506
Hydraulic Oil Filter Transmission...	HC-5501
Hydraulic Oil Filter.....	HC-5512
Oil Filter Full Flow.....	C-5102
426C (BACKHOE LOADERS) S/N: 1NR1-953	
Air Filter Primary.....	A-76231
Air Filter Secondary.....	A-5540
Air Filter Primary.....	A-5541
Air Filter Primary.....	A-5541M
Air Filter Set.....	A-5541M-S
Hydraulic Oil Filter.....	HC-5512
Hydraulic Oil Filter Transmission...	HC-5501
Hydraulic Oil Filter.....	HC-5506
Hydraulic Oil Filter.....	HC-5503
Oil Filter Full Flow.....	C-5102
426C (BACKHOE LOADERS) S/N: 1NR954-1049	
Air Filter Set.....	A-5541M-S
Air Filter Primary.....	A-5541M
Air Filter Primary.....	A-5541
Air Filter Secondary.....	A-5540
Air Filter Primary.....	A-76231
Hydraulic Oil Filter Transmission...	HC-5501
Hydraulic Oil Filter.....	HC-5512
Oil Filter Full Flow.....	C-5102
426C (BACKHOE LOADERS) S/N: 1YR1-1516	
Air Filter Primary.....	A-76231
Air Filter Secondary.....	A-5540
Air Filter Primary.....	A-5541
Air Filter Primary.....	A-5541M
Air Filter Set.....	A-5541M-S
Hydraulic Oil Filter.....	HC-5512
Hydraulic Oil Filter Transmission...	HC-5501
Hydraulic Oil Filter.....	HC-5506
Oil Filter Full Flow.....	C-5102
426C (BACKHOE LOADERS) S/N: 1YR1517-UP	
Air Filter Primary.....	A-76231
Air Filter Set.....	A-5541M-S
Air Filter Primary.....	A-5541M
Air Filter Primary.....	A-5541
Air Filter Secondary.....	A-5540
Hydraulic Oil Filter Transmission...	HC-5501
Hydraulic Oil Filter.....	HC-5512
Oil Filter Full Flow.....	C-5102
426C (BACKHOE LOADERS) S/N: 1ZR1000-UP	
Air Filter Primary.....	A-76231
Air Filter Secondary.....	A-5540

MODEL/APPLICATION	SAKURA NO
CATERPILLAR	
Air Filter Primary.....	A-5541
Air Filter Primary.....	A-5541M
Air Filter Set.....	A-5541M-S
Hydraulic Oil Filter.....	HC-5506
Hydraulic Oil Filter.....	HC-5512
Hydraulic Oil Filter Transmission...	HC-5501
Oil Filter Full Flow.....	C-5102
426C (BACKHOE LOADERS) S/N: 1ZR1-925	
Air Filter Primary.....	A-76231
Air Filter Set.....	A-5541M-S
Air Filter Primary.....	A-5541M
Air Filter Primary.....	A-5541
Air Filter Secondary.....	A-5540
Hydraulic Oil Filter Transmission...	HC-5501
Hydraulic Oil Filter.....	HC-5512
Hydraulic Oil Filter.....	HC-5506
Hydraulic Oil Filter.....	HC-5503
Oil Filter Full Flow.....	C-5102
426C (BACKHOE LOADERS) S/N: 1ZR926-999	
Air Filter Primary.....	A-76231
Air Filter Secondary.....	A-5540
Air Filter Primary.....	A-5541
Air Filter Primary.....	A-5541M
Air Filter Set.....	A-5541M-S
Hydraulic Oil Filter.....	HC-5512
Hydraulic Oil Filter Transmission...	HC-5501
Oil Filter Full Flow.....	C-5102
426C (BACKHOE LOADERS) S/N: 6XN1-3615	
Air Filter Set.....	A-5541M-S
Air Filter Primary.....	A-5541M
Air Filter Primary.....	A-5541
Air Filter Secondary.....	A-5540
Air Filter Primary.....	A-76231
Hydraulic Oil Filter Transmission...	HC-5501
Hydraulic Oil Filter.....	HC-5512
Hydraulic Oil Filter.....	HC-5506
Oil Filter Full Flow.....	C-5102
426C (BACKHOE LOADERS) S/N: 6XN3616-UP	
Air Filter Primary.....	A-76231
Air Filter Secondary.....	A-5540
Air Filter Primary.....	A-5541
Air Filter Primary.....	A-5541M
Air Filter Set.....	A-5541M-S
Hydraulic Oil Filter.....	HC-5512
Hydraulic Oil Filter Transmission...	HC-5501
Oil Filter Full Flow.....	C-5102
426C (BACKHOE LOADERS) S/N: 7WN1100-UP	
Air Filter Set.....	A-5541M-S
Air Filter Primary.....	A-5541M
Air Filter Primary.....	A-5541
Air Filter Secondary.....	A-5540
Air Filter Primary.....	A-76231
Hydraulic Oil Filter Transmission...	HC-5501
Hydraulic Oil Filter.....	HC-5512

MODEL/APPLICATION	SAKURA NO
CATERPILLAR	
Hydraulic Oil Filter.....	HC-5506
Oil Filter Full Flow.....	C-5102
426C (BACKHOE LOADERS) S/N: 7WN1-938	
Air Filter Secondary.....	A-5540
Air Filter Primary.....	A-5541
Air Filter Primary.....	A-5541M
Air Filter Set.....	A-5541M-S
Air Filter Primary.....	A-76231
Hydraulic Oil Filter Transmission...	HC-5501
Hydraulic Oil Filter.....	HC-5506
Hydraulic Oil Filter.....	HC-5503
Oil Filter Full Flow.....	C-5102
426C (BACKHOE LOADERS) S/N: 7WN939-1099	
Air Filter Primary.....	A-76231
Air Filter Set.....	A-5541M-S
Air Filter Primary.....	A-5541M
Air Filter Primary.....	A-5541
Air Filter Secondary.....	A-5540
Hydraulic Oil Filter Transmission...	HC-5501
Hydraulic Oil Filter.....	HC-5512
Oil Filter Full Flow.....	C-5102
427F2 (BACKHOE LOADERS) C3.4B	
Fuel Filter.....	EF-55040
427F2 (BACKHOE LOADERS) CAT C3.4	
Cabin Air Filter.....	CA-55110
428 (LOADERS) S/N: 6TC1-UP	
Air Filter Set.....	A-5579-S
Air Filter Set.....	A-5578-S
Air Filter Primary.....	A-5577
Air Filter Secondary.....	A-5580
Fuel Filter.....	FC-5103
Fuel Filter.....	FC-1010
Hydraulic Oil Filter.....	H-5506
Hydraulic Oil Filter.....	H-5510
Hydraulic Oil Filter Transmission...	HC-5501
Oil Filter Full Flow.....	C-5101
428B (BACKHOE LOADERS) PERKINS (S/N: 3KK1-2999)	
Air Filter Secondary.....	A-5580
Air Filter Primary.....	A-5577
Air Filter Set.....	A-5578-S
Air Filter Set.....	A-5579-S
Hydraulic Oil Filter.....	HC-5512
Hydraulic Oil Filter.....	HC-5506
Hydraulic Oil Filter.....	HC-5503
Oil Filter Full Flow.....	C-5102
428B (BACKHOE LOADERS) PERKINS (S/N: 7EJ1-5999)	
Air Filter Set.....	A-5578-S
Air Filter Primary.....	A-5577
Air Filter Secondary.....	A-5580
Air Filter Set.....	A-5579-S
Hydraulic Oil Filter.....	HC-5503

MODEL/APPLICATION	SAKURA NO	MODEL/APPLICATION	SAKURA NO	MODEL/APPLICATION	SAKURA NO
CATERPILLAR		CATERPILLAR		CATERPILLAR	
428B (BACKHOE LOADERS) PERKINS (S/N: 7EJ1-5999)		Hydraulic Oil Filter.....	HC-5512	Air Filter Set.....	A-5579-S
Hydraulic Oil Filter.....	HC-5506	Oil Filter Full Flow.....	C-5102	Hydraulic Oil Filter.....	H-5506
Hydraulic Oil Filter.....	HC-5512	428C (BACKHOE LOADERS) S/N: 2CR1-UP		Hydraulic Oil Filter.....	H-5510
Oil Filter Full Flow.....	C-5102	Air Filter Primary.....	A-76231	Oil Filter Full Flow.....	C-5101
Oil Filter Full Flow.....	C-5101	Air Filter Set.....	A-5541M-S	428 SERIES II (BACKHOE LOADERS) CAT 3054 (S/N: 6TC8000-UP)	
428B (BACKHOE LOADERS) S/N: 7EJ6000-UP		Air Filter Primary.....	A-5541M	Air Filter Set.....	A-5579-S
Air Filter Secondary.....	A-5580	Air Filter Primary.....	A-5541	Air Filter Set.....	A-5578-S
Air Filter Primary.....	A-5577	Air Filter Secondary.....	A-5540	Air Filter Primary.....	A-5577
Air Filter Set.....	A-5578-S	Hydraulic Oil Filter.....	HC-5512	Air Filter Secondary.....	A-5580
Air Filter Set.....	A-5579-S	Oil Filter Full Flow.....	C-5102	Fuel Filter.....	FC-5103
Hydraulic Oil Filter.....	HC-5512	428D (BACKHOE LOADERS) CAT 3054 (S/N: BLL1-UP)		Hydraulic Oil Filter.....	H-5506
Hydraulic Oil Filter.....	HC-5506	Hydraulic Oil Filter.....	HC-5512	Hydraulic Oil Filter.....	H-5510
Hydraulic Oil Filter.....	HC-5503	Oil Filter Full Flow.....	C-5101	Oil Filter Full Flow.....	C-5101
Oil Filter Full Flow.....	C-5101	Oil Filter Full Flow.....	C-5102	428F2 (BACKHOE LOADERS) C4.4	
Oil Filter Full Flow.....	C-5102	428D (BACKHOE LOADERS) CAT 3054 (S/N: BMT1-UP)		Fuel Filter.....	EF-55040
428C (BACKHOE LOADERS) CAT 3054 (S/N: 8RN1-UP) , 2008-UP		Air Filter Secondary.....	A-5540	428F (BACKHOE LOADERS) C4.4	
Air Filter Secondary.....	A-5540	Fuel Filter.....	FS-5701	Cabin Air Filter.....	CA-55110
Oil Filter Full Flow.....	C-5101	Hydraulic Oil Filter.....	HC-5512	430D (BACKHOE LOADERS) CAT 3054 (S/N: BML02281-BML04799)	
Oil Filter Full Flow.....	C-5102	Oil Filter Full Flow.....	C-5102	Air Filter Secondary.....	A-5540
428C (BACKHOE LOADERS) S/N: 1HR1-300 , 2005-UP		428D (BACKHOE LOADERS) CAT 3054 (S/N: BNB1-UP)		Fuel Filter.....	FS-5701
Air Filter Secondary.....	A-5540	Hydraulic Oil Filter.....	HC-5512	Oil Filter Full Flow.....	C-5102
428C (BACKHOE LOADERS) CAT 7B1-UP		Oil Filter Full Flow.....	C-5101	430D (BACKHOE LOADERS) CAT 3054 (S/N: BML02281-UP)	
Air Filter Primary.....	A-56731	Oil Filter Full Flow.....	C-5102	Air Filter Secondary.....	A-5540
Air Filter Secondary.....	A-56741	428D (BACKHOE LOADERS) CAT 3054 (S/N: BNS1-UP)		Fuel Filter.....	FS-5701
Air Filter Set.....	A-56731-S	Air Filter Secondary.....	A-5540	Oil Filter Full Flow.....	C-5102
428C (BACKHOE LOADERS) PERKINS (S/N: 7EJ1-UP)		Hydraulic Oil Filter.....	HC-5512	430D (BACKHOE LOADERS) CAT 3054 (S/N: BML04800-UP)	
Air Filter Set.....	A-5579-S	Oil Filter Full Flow.....	C-5102	Fuel Filter.....	FS-5701
Air Filter Set.....	A-5578-S	428D (BACKHOE LOADERS) CAT 3054 (S/N: BXC1-UP)		Hydraulic Oil Filter.....	HC-5512
Air Filter Primary.....	A-5577	Fuel Filter.....	FS-5701	Oil Filter Full Flow.....	C-5102
Air Filter Secondary.....	A-5580	Hydraulic Oil Filter.....	HC-5512	430D (BACKHOE LOADERS) CAT 3054 (S/N: BML1-UP)	
Hydraulic Oil Filter Transmission...	HC-5501	Oil Filter Full Flow.....	C-5102	Air Filter Secondary.....	A-5540
Oil Filter Full Flow.....	C-5101	428D (BACKHOE LOADERS) CAT 3054 (S/N: DSX1-UP)		Hydraulic Oil Filter.....	HC-5512
428C (BACKHOE LOADERS) PERKINS (S/N: 8RN1-UP)		Fuel Filter.....	FS-5701	Oil Filter Full Flow.....	C-5102
Air Filter Primary.....	A-76231	Hydraulic Oil Filter.....	HC-5512	430D (BACKHOE LOADERS) CAT 3054 (S/N: BNK05900-UP)	
Air Filter Set.....	A-5541M-S	Oil Filter Full Flow.....	C-5102	Fuel Filter.....	FS-5701
Air Filter Primary.....	A-5541M	428D (BACKHOE LOADERS) CAT 3054 (S/N: MBM1-UP)		Hydraulic Oil Filter.....	HC-5512
Air Filter Primary.....	A-5541	Fuel Filter.....	FS-5701	Oil Filter Full Flow.....	C-5102
Air Filter Secondary.....	A-5540	Hydraulic Oil Filter.....	HC-5512	430D (BACKHOE LOADERS) CAT 3054 (S/N: BNK1-UP)	
Fuel/Water Separator.....	SFC-5705	Oil Filter Full Flow.....	C-5102	Air Filter Secondary.....	A-5540
Hydraulic Oil Filter Transmission...	HC-5501	428E (BACKHOE LOADERS) CAT 3054DIT , 2006-UP		Hydraulic Oil Filter.....	HC-5512
Hydraulic Oil Filter.....	HC-5506	Fuel Filter.....	FS-5701	Oil Filter Full Flow.....	C-5102
Hydraulic Oil Filter.....	HC-5512	Hydraulic Oil Filter.....	HC-5512	430D (BACKHOE LOADERS) S/N: BNK02502-UP	
Oil Filter Full Flow.....	C-5102	Oil Filter Full Flow.....	C-5102	Air Filter Secondary.....	A-5540
Oil Filter Full Flow.....	C-5101	428 SERIES II (BACKHOE LOADERS) CAT 3054 (S/N: 6TC6564-6TC7999)		Hydraulic Oil Filter.....	HC-5512
428C (BACKHOE LOADERS) S/N: 1SR1-UP		Air Filter Secondary.....	A-5580	Oil Filter Full Flow.....	C-5102
Air Filter Primary.....	A-76231	Air Filter Primary.....	A-5577	430D (BACKHOE LOADERS) S/N: BNK02502-UP	
Air Filter Secondary.....	A-5540	Air Filter Set.....	A-5578-S	Air Filter Secondary.....	A-5540
Air Filter Primary.....	A-5541	428 SERIES II (BACKHOE LOADERS) CAT 3054 (S/N: 6TC6564-6TC7999)		Fuel Filter.....	FS-5701
Air Filter Primary.....	A-5541M	Air Filter Secondary.....	A-5580	Oil Filter Full Flow.....	C-5102
Air Filter Primary.....	A-5541M	Air Filter Primary.....	A-5577	430D (BACKHOE LOADERS) S/N: BNK02502-UP	
Air Filter Set.....	A-5541M-S	Air Filter Set.....	A-5578-S	Air Filter Secondary.....	A-5540

Sakura Filter

ENGINE APPLICATION

MODEL/APPLICATION	SAKURA NO	MODEL/APPLICATION	SAKURA NO	MODEL/APPLICATION	SAKURA NO
CATERPILLAR		CATERPILLAR		CATERPILLAR	
430E (BACKHOE LOADERS) CAT C4.4		Hydraulic Oil Filter.....	HC-5512	436C (BACKHOE LOADERS) CAT 3054 (S/N: 1FR1416-UP)	
Cabin Air Filter.....	CA-55110	Oil Filter Full Flow.....	C-5102	Air Filter Secondary.....	A-5540
430E (BACKHOE LOADERS) CAT S/N: CRS1-UP		434E (BACKHOE LOADERS) CAT S/N: FSH1-UP		Hydraulic Oil Filter.....	HC-5512
Hydraulic Oil Filter.....	HC-5512	Hydraulic Oil Filter.....	HC-5512	Oil Filter Full Flow.....	C-5102
Oil Filter Full Flow.....	C-5102	Oil Filter Full Flow.....	C-5102	436C (BACKHOE LOADERS) CAT 3054 (S/N: 1GR1-915-UP)	
430E (BACKHOE LOADERS) CAT S/N: DDT1-UP		434E (BACKHOE LOADERS) CAT S/N: G4D1-UP		Air Filter Secondary.....	A-5540
Hydraulic Oil Filter.....	HC-5512	Hydraulic Oil Filter.....	HC-5512	Hydraulic Oil Filter.....	HC-5506
Oil Filter Full Flow.....	C-5102	Oil Filter Full Flow.....	C-5102	Hydraulic Oil Filter.....	HC-5503
430E (BACKHOE LOADERS) CAT S/N: EAT1-UP		436 (BACKHOE LOADERS) PERKINS 4.236 (S/N: 5KF1-UP)		Oil Filter Full Flow.....	C-5102
Hydraulic Oil Filter.....	HC-5512	Air Filter Set.....	A-5579-S	436C (BACKHOE LOADERS) CAT 3054 (S/N: 1GR916-1GR949)	
Oil Filter Full Flow.....	C-5102	Air Filter Set.....	A-5578-S	Air Filter Secondary.....	A-5540
430E (BACKHOE LOADERS) CAT 3054C		Air Filter Primary.....	A-5577	Hydraulic Oil Filter.....	HC-5512
Cabin Air Filter.....	CA-55110	Air Filter Secondary.....	A-5580	Oil Filter Full Flow.....	C-5102
432D (BACKHOE LOADERS) CAT 3054 (S/N: BLD1-UP)		Fuel Filter.....	FC-5103	436C (BACKHOE LOADERS) CAT 3054 (S/N: 1GR950-UP)	
Air Filter Secondary.....	A-5540	Hydraulic Oil Filter.....	H-5506	Air Filter Secondary.....	A-5540
Fuel Filter.....	FS-5701	Hydraulic Oil Filter.....	H-5510	Hydraulic Oil Filter.....	HC-5503
Hydraulic Oil Filter.....	HC-5512	Oil Filter Full Flow.....	C-5101	Hydraulic Oil Filter.....	HC-5506
Oil Filter Full Flow.....	C-5102	436B (BACKHOE LOADERS) CAT 3054 (S/N: 6MJ1-UP)		Oil Filter Full Flow.....	C-5102
432D (BACKHOE LOADERS) CAT 3054 (S/N: TDR1-UP)		Air Filter Secondary.....	A-5580	436C (BACKHOE LOADERS) CAT 3054 (S/N: 1PR1-1598-UP)	
Fuel Filter.....	FS-5701	Air Filter Primary.....	A-5577	Air Filter Secondary.....	A-5540
Hydraulic Oil Filter.....	HC-5512	Air Filter Set.....	A-5578-S	Hydraulic Oil Filter.....	HC-5506
Oil Filter Full Flow.....	C-5102	Air Filter Set.....	A-5579-S	Hydraulic Oil Filter.....	HC-5503
432D (BACKHOE LOADERS) CAT 3054 (S/N: WEP1-UP)		Fuel Filter.....	FS-5701	Oil Filter Full Flow.....	C-5102
Fuel Filter.....	FS-5701	Hydraulic Oil Filter.....	HC-5506	436C (BACKHOE LOADERS) CAT 3054 (S/N: 1PR1599-UP)	
Hydraulic Oil Filter.....	HC-5512	Hydraulic Oil Filter.....	HC-5503	Air Filter Secondary.....	A-5540
Oil Filter Full Flow.....	C-5102	Oil Filter Full Flow.....	C-5101	Hydraulic Oil Filter.....	HC-5512
432E (BACKHOE LOADERS) 2008-UP		Oil Filter Full Flow.....	C-5102	Oil Filter Full Flow.....	C-5102
Hydraulic Oil Filter.....	HC-5512	436B (BACKHOE LOADERS) CAT 3054 (S/N: 7FL1-UP)		436C (BACKHOE LOADERS) CAT 3054 (S/N: 1RR1-997-UP)	
Oil Filter Full Flow.....	C-5102	Air Filter Set.....	A-5579-S	Air Filter Secondary.....	A-5540
432E (BACKHOE LOADERS) 3054C		Air Filter Set.....	A-5578-S	Hydraulic Oil Filter.....	HC-5503
Cabin Air Filter.....	CA-55110	Air Filter Primary.....	A-5577	Hydraulic Oil Filter.....	HC-5506
432E (BACKHOE LOADERS) C4.4		Air Filter Secondary.....	A-5580	Hydraulic Oil Filter.....	HC-5506
Cabin Air Filter.....	CA-55110	Hydraulic Oil Filter.....	HC-5503	Oil Filter Full Flow.....	C-5102
432F2 (BACKHOE LOADERS) C4.4		Hydraulic Oil Filter.....	HC-5506	436C (BACKHOE LOADERS) CAT 3054 (S/N: 2AR1-1603-UP)	
Fuel Filter.....	EF-55040	Hydraulic Oil Filter.....	HC-5512	Air Filter Secondary.....	A-5540
434E (BACKHOE LOADERS) 3054C		Hydraulic Oil Filter.....	HC-5503	Hydraulic Oil Filter.....	HC-5503
Cabin Air Filter.....	CA-55110	Oil Filter Full Flow.....	C-5102	Hydraulic Oil Filter.....	HC-5506
434E (BACKHOE LOADERS) C4.4		436C (BACKHOE LOADERS) CAT 3054 (S/N: 1FR1-1415-UP)		Oil Filter Full Flow.....	C-5102
Cabin Air Filter.....	CA-55110	Air Filter Secondary.....	A-5540	436C (BACKHOE LOADERS) CAT 3054 (S/N: 2AR1604-UP)	
434E (BACKHOE LOADERS) CAT S/N: CRS1-UP		Hydraulic Oil Filter.....	HC-5503	Air Filter Secondary.....	A-5540
Cabin Air Filter.....	CA-55110	Hydraulic Oil Filter.....	HC-5506	Hydraulic Oil Filter.....	HC-5512
		Oil Filter Full Flow.....	C-5102	Oil Filter Full Flow.....	C-5102

MODEL/APPLICATION	SAKURA NO	MODEL/APPLICATION	SAKURA NO	MODEL/APPLICATION	SAKURA NO
CATERPILLAR		CATERPILLAR		CATERPILLAR	
436C <i>(BACKHOE LOADERS)</i> CAT 3054 (S/N: 2BR1-910-UP)		Air Filter Secondary.....	A-5580	Oil Filter Full Flow.....	C-5101
Air Filter Secondary.....	A-5540	Air Filter Primary.....	A-5577	Oil Filter Full Flow.....	C-5102
Hydraulic Oil Filter.....	HC-5506	Air Filter Set.....	A-5578-S		
Hydraulic Oil Filter.....	HC-5503	Air Filter Set.....	A-5579-S	438C <i>(BACKHOE LOADERS)</i> CAT 3054 (S/N: 1TR1-1283-UP)	
Oil Filter Full Flow.....	C-5102	Fuel Filter.....	F-1901	Air Filter Secondary.....	A-5540
		Hydraulic Oil Filter.....	H-5506	Hydraulic Oil Filter.....	HC-5506
		Hydraulic Oil Filter Transmission...	HC-5501	Hydraulic Oil Filter.....	HC-5503
		Oil Filter Full Flow.....	C-5101	Oil Filter Full Flow.....	C-5102
436C <i>(BACKHOE LOADERS)</i> CAT 3054 (S/N: 2BR911-UP)				Oil Filter Full Flow.....	C-5101
Air Filter Secondary.....	A-5540	438 <i>(BACKHOE LOADERS)</i> PERKINS 4.236 (S/N: 3DJ1-827-UP)			
Hydraulic Oil Filter.....	HC-5503	Air Filter Secondary.....	A-5580	438C <i>(BACKHOE LOADERS)</i> CAT 3054 (S/N: 1TR1284-1TR1549)	
Hydraulic Oil Filter.....	HC-5506	Air Filter Primary.....	A-5577	Air Filter Secondary.....	A-5540
Oil Filter Full Flow.....	C-5102	Air Filter Set.....	A-5578-S	Hydraulic Oil Filter.....	HC-5512
		Air Filter Set.....	A-5579-S	Oil Filter Full Flow.....	C-5102
		Fuel Filter.....	FC-5103	Oil Filter Full Flow.....	C-5101
		Hydraulic Oil Filter.....	H-5506		
		Hydraulic Oil Filter.....	H-5510	438C <i>(BACKHOE LOADERS)</i> CAT 3054 (S/N: 1TR1550-UP)	
		Oil Filter Full Flow.....	C-5101	Air Filter Secondary.....	A-5540
436C <i>(BACKHOE LOADERS)</i> CAT 3054 (S/N: 7WN1-UP)				Hydraulic Oil Filter.....	HC-5503
Air Filter Secondary.....	A-5540	438 <i>(BACKHOE LOADERS)</i> PERKINS 4.236 (S/N: 3DJ828-UP)		Hydraulic Oil Filter.....	HC-5506
Hydraulic Oil Filter.....	HC-5506	Air Filter Set.....	A-5579-S	Oil Filter Full Flow.....	C-5101
Hydraulic Oil Filter.....	HC-5503	Air Filter Set.....	A-5578-S	Oil Filter Full Flow.....	C-5102
Oil Filter Full Flow.....	C-5102	Air Filter Primary.....	A-5577		
		Fuel Filter.....	FC-5103	438C <i>(BACKHOE LOADERS)</i> CAT 3054 (S/N: 2DR1-2716-UP)	
		Hydraulic Oil Filter.....	H-5510	Air Filter Secondary.....	A-5540
		Hydraulic Oil Filter.....	H-5506	Hydraulic Oil Filter.....	HC-5506
		Oil Filter Full Flow.....	C-5101	Hydraulic Oil Filter.....	HC-5512
				Hydraulic Oil Filter.....	HC-5503
436C <i>(BACKHOE LOADERS)</i> CAT 3054 (S/N: 8TN1-924-UP)		438B <i>(BACKHOE LOADERS)</i> CAT 3054 (S/N: 3KK1-2999-UP)		Oil Filter Full Flow.....	C-5102
Air Filter Secondary.....	A-5540	Air Filter Set.....	A-5579-S		
Hydraulic Oil Filter.....	HC-5503	Air Filter Set.....	A-5578-S	438C <i>(BACKHOE LOADERS)</i> CAT 3054 (S/N: 2DR2717-2DR3249)	
Hydraulic Oil Filter.....	HC-5506	Air Filter Primary.....	A-5577	Air Filter Secondary.....	A-5540
Oil Filter Full Flow.....	C-5102	Fuel Filter.....	FC-5103	Hydraulic Oil Filter.....	HC-5512
		Hydraulic Oil Filter.....	H-5510	Oil Filter Full Flow.....	C-5101
		Hydraulic Oil Filter.....	H-5506	Oil Filter Full Flow.....	C-5102
		Oil Filter Full Flow.....	C-5101		
436C <i>(BACKHOE LOADERS)</i> CAT 3054 (S/N: 8TN925-UP)				438C <i>(BACKHOE LOADERS)</i> CAT 3054 (S/N: 2DR3250-UP)	
Air Filter Secondary.....	A-5540	438B <i>(BACKHOE LOADERS)</i> CAT 3054 (S/N: 3KK1-2999-UP)		Air Filter Secondary.....	A-5540
Hydraulic Oil Filter.....	HC-5512	Air Filter Set.....	A-5579-S	Hydraulic Oil Filter.....	HC-5506
Oil Filter Full Flow.....	C-5102	Air Filter Set.....	A-5578-S	Hydraulic Oil Filter.....	HC-5503
		Air Filter Primary.....	A-5577	Oil Filter Full Flow.....	C-5101
		Air Filter Secondary.....	A-5580	Oil Filter Full Flow.....	C-5102
		Fuel Filter.....	FS-5701		
		Hydraulic Oil Filter.....	HC-5506	438C <i>(BACKHOE LOADERS)</i> CAT 3054 (S/N: 9KN1061-9KN1199)	
		Hydraulic Oil Filter.....	HC-5503	Air Filter Secondary.....	A-5540
		Oil Filter Full Flow.....	C-5101	Hydraulic Oil Filter.....	HC-5512
				Oil Filter Full Flow.....	C-5101
436C <i>(BACKHOE LOADERS)</i> CAT 3054 (S/N: 9JN1-883-UP)		438B <i>(BACKHOE LOADERS)</i> CAT 3054 (S/N: 3KK3000-UP)		Oil Filter Full Flow.....	C-5102
Air Filter Secondary.....	A-5540	Air Filter Secondary.....	A-5580		
Hydraulic Oil Filter.....	HC-5506	Air Filter Primary.....	A-5577	438C <i>(BACKHOE LOADERS)</i> CAT 3054 (S/N: 9KN1-1060-UP)	
Hydraulic Oil Filter.....	HC-5503	Air Filter Set.....	A-5578-S	Air Filter Secondary.....	A-5540
Oil Filter Full Flow.....	C-5102	Air Filter Set.....	A-5579-S	Hydraulic Oil Filter.....	HC-5503
		Fuel Filter.....	FS-5701	Hydraulic Oil Filter.....	HC-5506
		Hydraulic Oil Filter.....	HC-5503	Oil Filter Full Flow.....	C-5101
		Hydraulic Oil Filter.....	HC-5506	Oil Filter Full Flow.....	C-5102
		Oil Filter Full Flow.....	C-5101		
436C <i>(BACKHOE LOADERS)</i> CAT 7BJ1-UP		438C <i>(BACKHOE LOADERS)</i> CAT 3054 (S/N: 1JR1107-UP)		438C <i>(BACKHOE LOADERS)</i> CAT 3054 (S/N: 9KN1400-UP)	
Air Filter Set.....	A-56731-S	Air Filter Secondary.....	A-5540	Air Filter Secondary.....	A-5540
Air Filter Secondary.....	A-56741	Hydraulic Oil Filter.....	HC-5512	Hydraulic Oil Filter.....	HC-5503
Air Filter Primary.....	A-56731	Oil Filter Full Flow.....	C-5101	Hydraulic Oil Filter.....	HC-5506
		Oil Filter Full Flow.....	C-5102	Oil Filter Full Flow.....	C-5101
				Oil Filter Full Flow.....	C-5102
436 II <i>(BACKHOE LOADERS)</i> S/N: 5KF1-805-UP		438C <i>(BACKHOE LOADERS)</i> CAT 3054 (S/N: 1JR1-1106-UP)			
Air Filter Set.....	A-5579-S	Air Filter Secondary.....	A-5540	438C <i>(BACKHOE LOADERS)</i> CAT 3054 (S/N: 9KN1400-UP)	
Air Filter Set.....	A-5578-S	Hydraulic Oil Filter.....	HC-5512	Air Filter Secondary.....	A-5540
Air Filter Primary.....	A-5577	Oil Filter Full Flow.....	C-5101	Hydraulic Oil Filter.....	HC-5503
Air Filter Secondary.....	A-5580	Oil Filter Full Flow.....	C-5102	Hydraulic Oil Filter.....	HC-5506
Fuel Filter.....	F-1901			Oil Filter Full Flow.....	C-5101
Hydraulic Oil Filter Transmission...	HC-5501	438C <i>(BACKHOE LOADERS)</i> CAT 3054 (S/N: 1JR1-1106-UP)		Oil Filter Full Flow.....	C-5102
Oil Filter Full Flow.....	C-5101	Air Filter Secondary.....	A-5540		
		Hydraulic Oil Filter.....	HC-5506	438C <i>(BACKHOE LOADERS)</i> CAT 3054 (S/N: 9KN1400-UP)	
		Hydraulic Oil Filter.....	HC-5503	Air Filter Secondary.....	A-5540

MODEL/APPLICATION	SAKURA NO	MODEL/APPLICATION	SAKURA NO	MODEL/APPLICATION	SAKURA NO
CATERPILLAR		CATERPILLAR		CATERPILLAR	
438C (BACKHOE LOADERS) CAT 3054 (S/N: 9KN1400-UP) Air Filter Secondary..... A-5540 Hydraulic Oil Filter..... HC-5512 Oil Filter Full Flow..... C-5101 Oil Filter Full Flow..... C-5102		442E (BACKHOE LOADERS) CAT S/N: GKZ1-UP , 2006-UP Hydraulic Oil Filter..... HC-5512 Oil Filter Full Flow..... C-5102 442E (BACKHOE LOADERS) CAT S/N: LBE1-UP , 2006-UP Hydraulic Oil Filter..... HC-5512 Oil Filter Full Flow..... C-5102		446D (BACKHOE LOADERS) CAT 3114 Air Filter Primary..... A-5511 Air Filter Set..... A-5511-S Fuel Filter..... F-5505 Fuel Filter..... FS-5701 Fuel Filter..... FC-5508	
438C (BACKHOE LOADERS) CAT 7B11-UP Air Filter Primary..... A-56731 Air Filter Secondary..... A-56741 Air Filter Set..... A-56731-S		442E (BACKHOE LOADERS) C4.4 Cabin Air Filter..... CA-55110 442E (BACKHOE LOADERS) CAT 3054C Cabin Air Filter..... CA-55110 444E (BACKHOE LOADERS) C4.4 Cabin Air Filter..... CA-55110		446D (BACKHOE LOADERS) CAT 3114T Air Filter Primary..... A-4210 Air Filter Set..... A-4212-S Air Filter Secondary..... A-4211	
438D (BACKHOE LOADERS) CAT 3054 (S/N: BPE1-UP) Air Filter Secondary..... A-5540 Fuel Filter..... FS-5701 Hydraulic Oil Filter..... HC-5512 Oil Filter Full Flow..... C-5102		442E (BACKHOE LOADERS) CAT 3054C Cabin Air Filter..... CA-55110 444E (BACKHOE LOADERS) C4.4 Cabin Air Filter..... CA-55110		45 (TRACTORS) CAT (S/N: 9821-4349-UP) Fuel Filter Secondary..... FC-5515 Fuel Filter..... FC-5516 Fuel Filter Secondary..... FC-55151	
438D (BACKHOE LOADERS) CAT 3054 (S/N: BPN1-UP) Air Filter Secondary..... A-5540 Hydraulic Oil Filter..... HC-5512 Oil Filter Full Flow..... C-5102		442E (BACKHOE LOADERS) CAT 3054C Cabin Air Filter..... CA-55110 444E (BACKHOE LOADERS) CAT 3054C Cabin Air Filter..... CA-55110		45 (TRACTORS) CAT (S/N: 98214966-19755-UP) Fuel Filter Secondary..... FC-55151 Fuel Filter..... FC-5516 Fuel Filter Secondary..... FC-5515 Fuel Filter..... FC-5508	
438 SERIES II (BACKHOE LOADERS) CAT 3054 (S/N: 3DJ828-UP) Air Filter Secondary..... A-5580 Air Filter Primary..... A-5577 Air Filter Set..... A-5578-S Air Filter Set..... A-5579-S Fuel Filter..... FC-5103 Hydraulic Oil Filter..... H-5510 Hydraulic Oil Filter..... H-5506 Oil Filter Full Flow..... C-5101		442E (BACKHOE LOADERS) CAT 3114 (S/N: 6XF1-UP) Air Filter Primary..... A-5511 Air Filter Set..... A-5511-S Fuel Filter..... F-5505 Fuel Filter Secondary..... FC-5507 Hydraulic Oil Filter..... H-5506 Hydraulic Oil Filter..... H-5510 Hydraulic Oil Filter..... HC-5504 Oil Filter Full Flow..... C-5505		45 (TRACTORS) CAT S/N: 98Z19756-UP Fuel Filter Secondary..... FC-5515 Fuel Filter..... FC-5516 Fuel Filter Secondary..... FC-55151	
442D (BACKHOE LOADERS) CAT 3054 (S/N: BRG1-UP) Air Filter Secondary..... A-5540 Fuel Filter..... FS-5701 Hydraulic Oil Filter..... HC-5512 Oil Filter Full Flow..... C-5102		446B (BACKHOE LOADERS) CAT 3114 (S/N: 5BL1-2499-UP) Air Filter Set..... A-5511-S Air Filter Primary..... A-5511 Air Filter Primary..... A-76600 Fuel Filter..... F-5505 Fuel Filter Secondary..... FC-5507 Fuel Filter..... FC-5508 Fuel Filter..... FS-5701 Hydraulic Oil Filter..... HC-5504 Hydraulic Oil Filter..... HC-5503 Hydraulic Oil Filter..... HC-5512 Hydraulic Oil Filter..... HC-5506 Oil Filter Full Flow..... C-5505		45 (TRACTORS) CAT S/N: 98Z4350-14965-UP Fuel Filter Secondary..... FC-55151 Fuel Filter..... FC-5516 Fuel Filter Secondary..... FC-5515	
442D (BACKHOE LOADERS) CAT 3054 (S/N: BRV1-UP) Air Filter Secondary..... A-5540 Hydraulic Oil Filter..... HC-5512 Oil Filter Full Flow..... C-5102		446B (BACKHOE LOADERS) CAT 3114T Air Filter Secondary..... A-4211 Air Filter Set..... A-4212-S Air Filter Primary..... A-4210		45 (TRACTORS) S/N: 1DR1106-UP Air Filter Primary..... A-5549M Air Filter Primary..... A-5549 Air Filter Set..... A-5549M-S Air Filter Secondary..... A-5550 Hydraulic Oil Filter..... HC-5506 Hydraulic Oil Filter..... HC-5512 Hydraulic Oil Filter..... HC-5504 Hydraulic Oil Filter..... HC-5503	
442D (BACKHOE LOADERS) CAT 3054 (S/N: SMJ1-UP) Fuel Filter..... FS-5701 Hydraulic Oil Filter..... HC-5512 Oil Filter Full Flow..... C-5102		446B (BACKHOE LOADERS) CAT 3114T Air Filter Secondary..... A-4211 Air Filter Set..... A-4212-S Air Filter Primary..... A-4210		45 (TRACTORS) S/N: 1DR1-1105-UP Air Filter Secondary..... A-5550 Air Filter Set..... A-5549M-S Air Filter Primary..... A-5549 Air Filter Primary..... A-5549M Hydraulic Oil Filter..... HC-5503 Hydraulic Oil Filter..... HC-5504 Hydraulic Oil Filter..... HC-5512 Hydraulic Oil Filter..... HC-5506	
442D (BACKHOE LOADERS) CAT 3054 (S/N: TBD1-UP) Fuel Filter..... FS-5701 Hydraulic Oil Filter..... HC-5512 Oil Filter Full Flow..... C-5102		446B (BACKHOE LOADERS) S/N: 5BL2500-UP Air Filter Primary..... A-76600 Fuel Filter..... FS-5701 Fuel Filter..... FC-5508 Fuel Filter Secondary..... FC-5507 Hydraulic Oil Filter..... HC-5512 Oil Filter Full Flow..... C-5505		45 (TRACTORS) S/N: 3BK1-UP Air Filter Primary..... A-5549M Air Filter Primary..... A-5549	
442E (BACKHOE LOADERS) CAT S/N: CRS1-UP , 2006-UP Hydraulic Oil Filter..... HC-5512 Oil Filter Full Flow..... C-5102		446B (BACKHOE LOADERS) S/N: 5BL2500-UP Air Filter Primary..... A-76600 Fuel Filter..... FS-5701 Fuel Filter..... FC-5508 Fuel Filter Secondary..... FC-5507 Hydraulic Oil Filter..... HC-5512 Oil Filter Full Flow..... C-5505		45 (TRACTORS) S/N: 3BK1-UP Air Filter Primary..... A-5549M Air Filter Primary..... A-5549	

MODEL/APPLICATION	SAKURA NO	MODEL/APPLICATION	SAKURA NO	MODEL/APPLICATION	SAKURA NO
CATERPILLAR		CATERPILLAR		CATERPILLAR	
45 (TRACTORS) S/N: 3BK1-UP Air Filter Set..... A-5549M-S Air Filter Secondary..... A-5550 Hydraulic Oil Filter..... HC-5504		Air Filter Primary..... A-5566 Air Filter..... A-5530 Air Filter Primary..... A-5507 Air Filter Set..... A-5507-S Air Filter Set..... A-55071-S Air Filter Set..... A-5568-S Fuel Filter Secondary..... FC-5507 Fuel Filter..... F-5505 Hydraulic Oil Filter..... H-5506 Oil Filter Full Flow..... C-5505		Coolant Filter..... WC-5705 Fuel Filter..... FC-5509 Fuel Filter..... F-5505 Hydraulic Oil Filter..... H-5505 Oil Filter Full Flow..... C-5516	
45 (TRACTORS) S/N: 4DZ1-2123-UP Air Filter Secondary..... A-5550 Air Filter Set..... A-5549M-S Air Filter Primary..... A-5549 Air Filter Primary..... A-5549M Hydraulic Oil Filter..... HC-5504 Hydraulic Oil Filter..... HC-5503 Hydraulic Oil Filter..... HC-5506 Hydraulic Oil Filter..... HC-5512		508 (SKIDDERS) S/N: 9DA1-UP Fuel Filter Secondary..... FC-5507 Oil Filter Full Flow..... C-5505		5090B (EXCAVATORS) CAT 3456 (S/N: CLD1-UP) Air Filter Primary..... A-5593 Air Filter Set..... A-5595-S Air Filter Secondary..... A-5594 Fuel Filter..... FC-5517 Fuel/Water Separator Secondary.. SFC-5504-10 Fuel/Water Separator Secondary.. SFC-5504-10B Hydraulic Oil Filter..... HC-5516 Hydraulic Oil Filter..... H-7942	
45 (TRACTORS) S/N: 4KW1-UP Air Filter Primary..... A-5549M Air Filter Primary..... A-5549 Air Filter Set..... A-5549M-S Air Filter Secondary..... A-5550 Hydraulic Oil Filter..... HC-5504		508 (SKIDDERS) S/N: 9NC1-UP Air Filter Primary..... A-5566 Air Filter Secondary..... A-5567 Air Filter..... A-5530 Air Filter Set..... A-5568-S Air Filter Set..... A-55071-S Air Filter Set..... A-5507-S Air Filter Primary..... A-5507 Fuel Filter..... F-5505 Fuel Filter Secondary..... FC-5507 Hydraulic Oil Filter..... H-5506 Oil Filter Full Flow..... C-5505		5090B (EXCAVATORS) CAT 3456 (S/N: SJY1-UP) Air Filter Secondary..... A-5594 Air Filter Set..... A-5595-S Air Filter Primary..... A-5593 Fuel Filter..... FC-5517 Fuel/Water Separator Secondary.. SFC-5504-10B Fuel/Water Separator Secondary.. SFC-5504-10 Hydraulic Oil Filter..... H-7942 Hydraulic Oil Filter..... HC-5516	
45 (TRACTORS) S/N: 4YL1-UP Air Filter Secondary..... A-5550 Air Filter Set..... A-5549M-S Air Filter Primary..... A-5549 Air Filter Primary..... A-5549M Hydraulic Oil Filter..... HC-5504		5080 (EXCAVATORS) CAT 3406B (Excluding S/N: 11N6900) Air Filter Secondary..... A-5715 Coolant Filter..... WC-5707 Coolant Filter..... WC-5705 Fuel Filter..... F-5505 Fuel Filter..... FC-5509 Hydraulic Oil Filter..... H-5505		5090B FS (EXCAVATORS) CAT 3456 (S/N: CLD1-UP) Air Filter Secondary..... A-5594 Air Filter Set..... A-5595-S Air Filter Primary..... A-5593 Fuel Filter..... FC-5517 Fuel/Water Separator Secondary.. SFC-5504-10B Fuel/Water Separator Secondary.. SFC-5504-10 Hydraulic Oil Filter..... HC-5516	
45 (TRACTORS) S/N: ABF1-UP Air Filter Primary..... A-5549M Air Filter Primary..... A-5549 Air Filter Set..... A-5549M-S Air Filter Secondary..... A-5550 Hydraulic Oil Filter..... HC-5504		5080 (EXCAVATORS) CAT 3406B (S/N: 6XK1-UP) Air Filter Primary..... A-5629 Air Filter Set..... A-5629-S Air Filter Secondary..... A-5715 Air Filter Secondary..... A-5630 Fuel Filter..... FC-5509 Fuel Filter..... F-5505 Hydraulic Oil Filter..... HC-5516 Hydraulic Oil Filter..... H-5505		5110 (EXCAVATORS) CAT 3412E (S/N: 7GN1-UP) , 2007-UP Air Filter Set..... A-5555-S Air Filter Primary..... A-5555 Air Filter Secondary..... A-5560 Fuel Filter..... FC-5509 Hydraulic Oil Filter..... HC-5516	
450E (BACKHOE LOADERS) C4.4 Cabin Air Filter..... CA-55110		5080 (EXCAVATORS) CAT 3406B (S/N: 8SL1-UP) Air Filter Secondary..... A-5630 Air Filter Set..... A-5629-S Air Filter Primary..... A-5629 Fuel Filter..... F-5505 Fuel Filter..... FC-5509 Hydraulic Oil Filter..... H-5505 Hydraulic Oil Filter..... HC-5516		5110 (EXCAVATORS) CAT 3412E (S/N: 8HN1-UP) , 2007-UP Air Filter Secondary..... A-5560 Air Filter Primary..... A-5555 Air Filter Set..... A-5555-S Fuel Filter..... FC-5509 Hydraulic Oil Filter..... HC-5516	
450F (BACKHOE LOADERS) C4.4 Cabin Air Filter..... CA-55110		5080 (EXCAVATORS) CAT 3406B S/N: 6XK1-UP Air Filter Secondary..... A-5715 Coolant Filter..... WC-5707		5110 (EXCAVATORS) CAT 3412 Fuel/Water Separator Primary... SFC-5504-30B Fuel/Water Separator Primary... SFC-5504-30	
465 (COMBINES HARVESTERS) CAT 3126 Fuel Filter Secondary..... FC-5515 Fuel Filter Secondary..... FC-55151 Fuel Filter..... FC-5516 Oil Filter Full Flow..... C-5510		5080 (EXCAVATORS) CAT 3406B S/N: 8SL1-UP Air Filter Secondary..... A-5630 Air Filter Set..... A-5629-S Air Filter Primary..... A-5629 Fuel Filter..... F-5505 Fuel Filter..... FC-5509 Hydraulic Oil Filter..... H-5505 Hydraulic Oil Filter..... HC-5516		5110 (EXCAVATORS) CAT 3412 Fuel/Water Separator Primary... SFC-5504-30B Fuel/Water Separator Primary... SFC-5504-30	
50 (HYDRAULIC SYSTEMS) S/N: 14E1-14E1117 Hydraulic Oil Filter..... H-5503		5080 (EXCAVATORS) CAT 3406B S/N: 6XK1-UP Air Filter Secondary..... A-5715 Coolant Filter..... WC-5707		5110 (EXCAVATORS) CAT S/N: 5111-UP Air Filter..... A-5584 Air Filter Secondary..... A-8651 Fuel Filter..... FC-5517 Hydraulic Oil Filter..... HC-5801	
50 (HYDRAULIC SYSTEMS) S/N: 61D1-61D95 Hydraulic Oil Filter..... H-5503		5080 (SKIDDERS) S/N: 2HD1-UP Air Filter Secondary..... A-5567			

MODEL/APPLICATION	SAKURA NO
CATERPILLAR	
511 (FELLER BUNCHERS) CAT S/N: 5111-UP	
Hydraulic Oil Filter.....	H-5509
Hydraulic Oil Filter.....	HC-55170
511 (FELLER BUNCHERS) CAT S/N: 5211-UP	
Air Filter Secondary.....	A-8651
Air Filter.....	A-5584
Fuel Filter.....	FC-5517
Hydraulic Oil Filter.....	HC-55170
Hydraulic Oil Filter.....	H-5509
Hydraulic Oil Filter.....	HC-5801
511 (FELLER BUNCHERS) CAT S/N: 5221-UP	
Air Filter.....	A-5584
Air Filter Secondary.....	A-8651
Fuel Filter.....	FC-5517
Hydraulic Oil Filter.....	HC-5801
Hydraulic Oil Filter.....	H-5509
Hydraulic Oil Filter.....	HC-55170
511 (FELLER BUNCHERS) CAT S/N: THX1-UP	
Air Filter Secondary.....	A-8651
Air Filter.....	A-5584
Fuel Filter.....	FC-5517
Hydraulic Oil Filter.....	HC-55170
Hydraulic Oil Filter.....	H-5509
Hydraulic Oil Filter.....	HC-5801
5110B (EXCAVATORS) CAT 3412E	
Fuel/Water Separator Primary....	SFC-5504-30
Fuel/Water Separator Primary....	SFC-5504-30B
5110B (EXCAVATORS) CAT 3412E (S/N: AAA1-UP)	
Air Filter Set.....	A-5555-S
Air Filter Secondary.....	A-5556
Air Filter Primary.....	A-5555
Cabin Air Filter.....	CA-55850
Fuel Filter.....	FC-5509
Fuel/Water Separator Secondary..	SFC-5504-10
Fuel/Water Separator Secondary..	SFC-5504-10B
Hydraulic Oil Filter.....	H-5506
Hydraulic Oil Filter.....	HC-5516
Hydraulic Oil Filter.....	H-5001
Oil Filter Full Flow.....	C-5516
5110B (EXCAVATORS) CAT 3412E (S/N: AAK1-226-UP)	
Air Filter Secondary.....	A-5556
Air Filter Set.....	A-5555-S
Air Filter Primary.....	A-5555
Cabin Air Filter.....	CA-55850
Fuel Filter.....	FC-5509
Fuel/Water Separator Secondary..	SFC-5504-10B
Fuel/Water Separator Secondary..	SFC-5504-10
Hydraulic Oil Filter.....	H-5506
Hydraulic Oil Filter.....	H-5501
Hydraulic Oil Filter.....	H-5001
5110B (EXCAVATORS) CAT 3412E (S/N: AAK1-UP)	

MODEL/APPLICATION	SAKURA NO
CATERPILLAR	
Air Filter Primary.....	A-5555
Air Filter Set.....	A-5555-S
Air Filter Secondary.....	A-5556
Cabin Air Filter.....	CA-55850
Fuel Filter.....	FC-5509
Fuel/Water Separator Secondary..	SFC-5504-10
Fuel/Water Separator Secondary..	SFC-5504-10B
Hydraulic Oil Filter.....	H-5506
Hydraulic Oil Filter.....	H-5001
5110B (EXCAVATORS) CAT 3412E (S/N: AAK227-UP)	
Air Filter Secondary.....	A-5556
Air Filter Set.....	A-5555-S
Air Filter Primary.....	A-5555
Cabin Air Filter.....	CA-55850
Fuel Filter.....	FC-5509
Fuel/Water Separator Secondary..	SFC-5504-10B
Fuel/Water Separator Secondary..	SFC-5504-10
Hydraulic Oil Filter.....	H-5506
Hydraulic Oil Filter.....	H-5001
5130 (EXCAVATORS) CAT 3508 (S/N: 5ZL1-UP)	
Air Filter Secondary.....	A-55291
Air Filter Primary.....	A-5532
Air Filter Set.....	A-5532-S
Air Filter.....	A-5547
Air Filter Set.....	A-5565-S
Air Filter Secondary.....	A-5563
Air Filter Primary.....	A-5564
Fuel Filter.....	FC-5510
Hydraulic Oil Filter.....	H-5506
Hydraulic Oil Filter.....	HC-5516
5130 (EXCAVATORS) CAT 3508 (S/N: 7TJ1-UP)	
Air Filter Primary.....	A-5564
Air Filter Secondary.....	A-5563
Air Filter Set.....	A-5565-S
Air Filter.....	A-5547
Fuel Filter.....	FC-5510
Hydraulic Oil Filter.....	HC-5516
Hydraulic Oil Filter.....	H-5506
5130B (EXCAVATORS) CAT 3508B (S/N: 4CS1-UP)	
Air Filter.....	A-5547
Air Filter Primary.....	A-5564
Air Filter Secondary.....	A-5563
Air Filter Set.....	A-5565-S
Fuel Filter.....	FC-5510
Hydraulic Oil Filter.....	H-5506
Hydraulic Oil Filter.....	HC-5516
515 (SKIDDERS) CAT (S/N: 07Z32027-UP)	
Fuel Filter Secondary.....	FC-5507
Oil Filter Full Flow.....	C-5522
Oil Filter Full Flow.....	C-5510
515 (SKIDDERS) CAT 3304 (S/N: 4LR1-UP)	
Air Filter Set.....	A-5568-S

MODEL/APPLICATION	SAKURA NO
CATERPILLAR	
Air Filter Primary.....	A-5566
Air Filter Secondary.....	A-5567
Fuel Filter Secondary.....	FC-5507
Fuel Filter.....	F-5505
Hydraulic Oil Filter.....	H-5506
Hydraulic Oil Filter.....	H-5510
Hydraulic Oil Filter.....	HC-5504
Oil Filter Full Flow.....	C-5510
515 (SKIDDERS) S/N: 28H1-UP	
Fuel Filter Secondary.....	FC-5507
Hydraulic Oil Filter.....	H-5508
Hydraulic Oil Filter.....	H-5502
515 (SKIDDERS) S/N: 4LR718-UP	
Air Filter Secondary.....	A-5567
Air Filter Primary.....	A-5566
Air Filter Set.....	A-5568-S
Hydraulic Oil Filter.....	H-5506
Hydraulic Oil Filter.....	HC-5504
517 (SKIDDERS) CAT 3304 DIT	
Air Filter Set.....	A-5568-S
Air Filter Secondary.....	A-5567
Air Filter Primary.....	A-5566
Fuel Filter Secondary.....	FC-5507
Hydraulic Oil Filter.....	H-5504
Oil Filter Full Flow.....	C-5510
517 (SKIDDERS) CAT 3304 (S/N: 5WM1-UP)	
Air Filter Set.....	A-5568-S
Air Filter Primary.....	A-5566
Air Filter Secondary.....	A-5567
Fuel Filter Secondary.....	FC-5507
Hydraulic Oil Filter.....	H-5504
Oil Filter Full Flow.....	C-5510
517 (SKIDDERS) CAT 3304 (S/N: 6PW1-UP)	
Air Filter Secondary.....	A-5567
Air Filter Primary.....	A-5566
Air Filter Set.....	A-5568-S
Fuel Filter Secondary.....	FC-5507
Hydraulic Oil Filter.....	H-5504
Oil Filter Full Flow.....	C-5510
518C (SKIDDERS) CAT 3304	
Air Filter Set.....	A-55071-S
Air Filter Secondary.....	A-5508
Air Filter Set.....	A-5507-S
Air Filter Primary.....	A-5507
Fuel Filter.....	F-5505
Hydraulic Oil Filter.....	H-5504
Oil Filter Full Flow.....	C-5510
518C (SKIDDERS) CAT (S/N: 07Z28000-28000-UP)	
Fuel Filter Secondary.....	FC-5507
518C (SKIDDERS) CAT (S/N: 07Z28001-UP)	

MODEL/APPLICATION	SAKURA NO
CATERPILLAR	
518C (SKIDDERS) CAT (S/N: 07Z28001-UP)	
Fuel Filter Secondary.....	FC-5507
Oil Filter Full Flow.....	C-5522
518C (SKIDDERS) S/N: 1CL1-UP	
Air Filter Set.....	A-55071-S
Air Filter Primary.....	A-5507
Air Filter Set.....	A-5507-S
Air Filter Secondary.....	A-5508
Hydraulic Oil Filter.....	H-5502
Hydraulic Oil Filter.....	H-5508
518C (SKIDDERS) S/N: 2DX1-UP	
Hydraulic Oil Filter.....	H-55270
518C (SKIDDERS) S/N: 4MX1-UP	
Hydraulic Oil Filter.....	H-55270
518C (SKIDDERS) S/N: 81-UP	
Hydraulic Oil Filter.....	H-55270
518C (SKIDDERS) S/N: 9HJ1-UP	
Air Filter Secondary.....	A-5508
Air Filter Set.....	A-5507-S
Air Filter Primary.....	A-5507
Air Filter Set.....	A-55071-S
Hydraulic Oil Filter.....	H-5508
Hydraulic Oil Filter.....	H-5502
518 (SKIDDERS) CAT 3304 (S/N: 50S1-UP) , 2005-UP	
Air Filter Secondary.....	A-5508
Air Filter Set.....	A-55071-S
Air Filter Primary.....	A-5507
Air Filter Set.....	A-5507-S
Fuel Filter.....	F-5505
Fuel Filter Secondary.....	FC-5507
Hydraulic Oil Filter.....	H-5508
Hydraulic Oil Filter.....	H-5502
Hydraulic Oil Filter.....	H-5504
Oil Filter Full Flow.....	C-5510
518 (SKIDDERS) CAT 3304 (S/N: 55U1-UP) , 2005-UP	
Air Filter Set.....	A-5507-S
Air Filter Primary.....	A-5507
Air Filter Set.....	A-55071-S
Air Filter Secondary.....	A-5508
Fuel Filter.....	F-5505
Fuel Filter Secondary.....	FC-5507
Hydraulic Oil Filter.....	H-5504
Hydraulic Oil Filter.....	H-5502
Hydraulic Oil Filter.....	H-5508
Oil Filter Full Flow.....	C-5510
518 (SKIDDERS) CAT 3304 (S/N: 94U1-UP) , 2005-UP	
Air Filter Primary.....	A-5507
Air Filter Set.....	A-5507-S
Hydraulic Oil Filter.....	H-5504
Hydraulic Oil Filter.....	H-5502
Hydraulic Oil Filter.....	H-5508
Oil Filter Full Flow.....	C-5510

MODEL/APPLICATION	SAKURA NO
CATERPILLAR	
Air Filter Secondary.....	A-5508
Air Filter Set.....	A-55071-S
Fuel Filter Secondary.....	FC-5507
Fuel Filter.....	F-5505
Hydraulic Oil Filter.....	H-5508
Hydraulic Oil Filter.....	H-5502
Hydraulic Oil Filter.....	H-5504
Oil Filter Full Flow.....	C-5510
518 (SKIDDERS) CAT (S/N: 07Z1523-4628-UP)	
Oil Filter Full Flow.....	C-5522
Oil Filter Full Flow.....	C-5510
518 (SKIDDERS) CAT (S/N: 07Z4629-5693-UP)	
Oil Filter Full Flow.....	C-5510
Oil Filter Full Flow.....	C-5522
518 (SKIDDERS) CAT (S/N: 07Z5694-8941-UP)	
Fuel Filter.....	FC-5501
Oil Filter Full Flow.....	C-5522
Oil Filter Full Flow.....	C-5510
518 (SKIDDERS) CAT (S/N: 07Z8942-UP)	
Fuel Filter.....	FC-5501
Oil Filter Full Flow.....	C-5510
Oil Filter Full Flow.....	C-5522
518 (SKIDDERS)	
Fuel Filter.....	F-5503
518 (SKIDDERS) S/N: 1HE1-UP	
Hydraulic Oil Filter.....	H-5504
Hydraulic Oil Filter.....	H-55270
518 (SKIDDERS) S/N: 1ZC1-UP	
Hydraulic Oil Filter.....	H-55270
Hydraulic Oil Filter.....	H-5504
518 (SKIDDERS) S/N: 3GA1-UP	
Hydraulic Oil Filter.....	H-5504
Hydraulic Oil Filter.....	H-55270
518 (SKIDDERS) S/N: 4SA1-UP	
Hydraulic Oil Filter.....	H-55270
518 (SKIDDERS) S/N: 50S1-205	
Air Filter Primary.....	A-5566
Air Filter Secondary.....	A-5567
Air Filter Set.....	A-5568-S
Air Filter Set.....	A-55071-S
Air Filter Primary.....	A-5507
Air Filter Secondary.....	A-5508
Air Filter Set.....	A-5507-S
Fuel Filter Secondary.....	FC-5507
Hydraulic Oil Filter.....	H-5504
Hydraulic Oil Filter.....	H-5502
Hydraulic Oil Filter.....	H-5508
Oil Filter Full Flow.....	C-5510
518 (SKIDDERS) S/N: 94U2207-UP	
Air Filter Set.....	A-5507-S
Air Filter Secondary.....	A-5508
Air Filter Primary.....	A-5507
Air Filter Set.....	A-55071-S
518 (SKIDDERS) S/N: 94U691-2206-UP	
Air Filter Set.....	A-55071-S
Air Filter Primary.....	A-5507

MODEL/APPLICATION	SAKURA NO
CATERPILLAR	
Oil Filter Full Flow.....	O-5501
Oil Filter Full Flow.....	C-5510
518 (SKIDDERS) S/N: 50S206-UP	
Air Filter Set.....	A-5507-S
Air Filter Secondary.....	A-5508
Air Filter Primary.....	A-5507
Air Filter Set.....	A-55071-S
Air Filter Set.....	A-5568-S
Air Filter Secondary.....	A-5567
Air Filter Primary.....	A-5566
Fuel Filter Secondary.....	FC-5507
Hydraulic Oil Filter.....	H-5504
Hydraulic Oil Filter.....	H-5502
Hydraulic Oil Filter.....	H-5508
Oil Filter Full Flow.....	C-5510
518 (SKIDDERS) S/N: 50S3230-UP	
Air Filter Primary.....	A-5507
Air Filter Secondary.....	A-5508
Air Filter Set.....	A-5507-S
Air Filter Set.....	A-55071-S
518 (SKIDDERS) S/N: 55U-55U	
Air Filter Set.....	A-55071-S
Air Filter Set.....	A-5507-S
Air Filter Secondary.....	A-5508
Air Filter Primary.....	A-5507
Hydraulic Oil Filter.....	H-5508
Hydraulic Oil Filter.....	H-5502
Hydraulic Oil Filter.....	H-5504
Oil Filter Full Flow.....	C-5510
518 (SKIDDERS) S/N: 55U669-UP	
Air Filter Primary.....	A-5507
Air Filter Secondary.....	A-5508
Air Filter Set.....	A-5507-S
Air Filter Set.....	A-55071-S
518 (SKIDDERS) S/N: 94U1-UP	
Air Filter Set.....	A-55071-S
Air Filter Primary.....	A-5507
Air Filter Set.....	A-5507-S
Fuel Filter Secondary.....	FC-5507
Hydraulic Oil Filter.....	H-5504
Hydraulic Oil Filter.....	H-5502
Hydraulic Oil Filter.....	H-5508
Oil Filter Full Flow.....	C-5510
518 (SKIDDERS) S/N: 94U2207-UP	
Air Filter Set.....	A-5507-S
Air Filter Secondary.....	A-5508
Air Filter Primary.....	A-5507
Air Filter Set.....	A-55071-S
518 (SKIDDERS) S/N: 94U691-2206-UP	
Air Filter Set.....	A-55071-S
Air Filter Primary.....	A-5507

MODEL/APPLICATION	SAKURA NO	MODEL/APPLICATION	SAKURA NO	MODEL/APPLICATION	SAKURA NO
CATERPILLAR		CATERPILLAR		CATERPILLAR	
518 (SKIDDERS) S/N: 94U691-2206-UP	Air Filter Secondary..... A-5508 Air Filter Set..... A-5507-S	Air Filter Set..... A-55071-S		Air Filter Set..... A-5568-S	
518 (SKIDDERS) S/N: 95U101-2500-UP	Air Filter Set..... A-5507-S Air Filter Secondary..... A-5508 Air Filter Primary..... A-5507 Air Filter Set..... A-55071-S	518 II (SKIDDERS) S/N: 95U2501-UP	Air Filter Primary..... A-5507 Air Filter Set..... A-5507-S Air Filter Secondary..... A-5508 Air Filter Set..... A-55071-S	Hydraulic Oil Filter..... H-5506 Hydraulic Oil Filter..... H-5510 Hydraulic Oil Filter..... HC-5504	
518 (SKIDDERS) S/N: 95U1-UP	Air Filter Set..... A-55071-S Air Filter Primary..... A-5507 Air Filter Secondary..... A-5508 Air Filter Set..... A-5507-S Hydraulic Oil Filter..... H-5504 Hydraulic Oil Filter..... H-5508 Hydraulic Oil Filter..... H-5502 Oil Filter Full Flow..... C-5510	518 II (SKIDDERS) S/N: 9NE1-UP	Hydraulic Oil Filter..... H-55270 Hydraulic Oil Filter..... H-5504	525 (SKIDDERS) S/N: 1DN1-1068-UP	Air Filter Set..... A-5568-S Air Filter Secondary..... A-5567 Air Filter Primary..... A-5566 Hydraulic Oil Filter..... HC-5504 Hydraulic Oil Filter..... H-5510 Hydraulic Oil Filter..... H-5506
518 (SKIDDERS) S/N: 95U2501-UP	Air Filter Set..... A-5507-S Air Filter Primary..... A-5507 Air Filter Secondary..... A-5508 Air Filter Set..... A-5507-S Hydraulic Oil Filter..... H-5504 Hydraulic Oil Filter..... H-5508 Hydraulic Oil Filter..... H-5502 Oil Filter Full Flow..... C-5510	522C (FELLER BUNCHERS) CAT S/N: 07Z28250-UP	Air Filter Set..... A-5568-S Air Filter Secondary..... A-5567 Air Filter Primary..... A-5566 Fuel Filter Secondary..... FC-5507 Hydraulic Oil Filter..... HC-5504 Oil Filter Full Flow..... C-5522 Oil Filter Full Flow..... C-5510	525 (SKIDDERS) S/N: 1DN1969-UP	Air Filter Primary..... A-5566 Air Filter Secondary..... A-5567 Air Filter Set..... A-5568-S Hydraulic Oil Filter..... H-5506 Hydraulic Oil Filter..... H-5510 Hydraulic Oil Filter..... HC-5504
518 II (SKIDDERS) CAT (S/N: 07Z4629-5693-UP)	Oil Filter Full Flow..... C-5510	522C (FELLER BUNCHERS) CAT S/N: 2WL1-UP	Air Filter Primary..... A-5566 Air Filter Secondary..... A-5567 Air Filter Set..... A-5568-S Fuel Filter Secondary..... FC-5507 Hydraulic Oil Filter..... HC-5504 Oil Filter Full Flow..... C-5522 Oil Filter Full Flow..... C-5510	525 (SKIDDERS) S/N: 1DN1-UP	Fuel Filter Secondary..... FC-5507
518 II (SKIDDERS) CAT (S/N: 07Z8942-UP)	Oil Filter Full Flow..... C-5510	5230 (EXCAVATORS) CAT 3516 (S/N: 2PK1-UP)	Air Filter..... A-5547 Air Filter Set..... A-5565-S Air Filter Secondary..... A-5563 Air Filter Primary..... A-5564 Fuel Filter..... FC-5510 Hydraulic Oil Filter..... H-5506 Hydraulic Oil Filter..... H-5510		
518 II (SKIDDERS) S/N: 12C1-UP	Hydraulic Oil Filter..... H-55270 Hydraulic Oil Filter..... H-5504	5230 (EXCAVATORS) CAT 3516 (S/N: 7LL1-UP)	Air Filter Primary..... A-5564 Air Filter Secondary..... A-5563 Air Filter Set..... A-5565-S Air Filter..... A-5547 Fuel Filter..... FC-5510 Hydraulic Oil Filter..... H-5510 Hydraulic Oil Filter..... H-5506 Hydraulic Oil Filter..... HC-5516		
518 II (SKIDDERS) S/N: 7RE1-UP	Hydraulic Oil Filter..... H-5504 Hydraulic Oil Filter..... H-55270	525 (SKIDDERS) CAT (S/N: 07Z31733-UP)	Fuel Filter Secondary..... FC-5507 Oil Filter Full Flow..... C-5522 Oil Filter Full Flow..... C-5510		
518 II (SKIDDERS) S/N: 94U2207-UP	Air Filter Secondary..... A-5508 Air Filter Set..... A-5507-S Air Filter Primary..... A-5507 Air Filter Set..... A-55071-S	525 (SKIDDERS) CAT 3126 (S/N: 2KZ00797--00874)	Air Filter Set..... A-5568-S Air Filter Secondary..... A-5567 Air Filter Primary..... A-5566 Fuel Filter Secondary..... FC-5507 Hydraulic Oil Filter..... HC-5504 Oil Filter Full Flow..... C-5510	525B (SKIDDERS) CAT 3126 (S/N: 3KZ00875-UP)	Air Filter Set..... A-5534 Air Filter Primary..... A-5535 Air Filter Set..... A-5573-S Fuel Filter..... FC-5516 Fuel Filter Secondary..... FC-55151 Fuel Filter Secondary..... FC-5515 Hydraulic Oil Filter..... H-5510 Hydraulic Oil Filter..... H-5506 Hydraulic Oil Filter..... HC-5504 Oil Filter Full Flow..... C-5510
518 II (SKIDDERS) S/N: 94U691-2206-UP	Air Filter Primary..... A-5507 Air Filter Set..... A-5507-S Air Filter Secondary..... A-5508 Air Filter Set..... A-55071-S	525B (SKIDDERS) CAT 3126 (S/N: 3KZ1--00795)	Air Filter Secondary..... A-5566 Air Filter Set..... A-5567 Air Filter Primary..... A-5566 Fuel Filter Secondary..... FC-5507 Hydraulic Oil Filter..... HC-5504 Oil Filter Full Flow..... C-5510	525B (SKIDDERS) CAT 3126 (S/N: 3KZ1--00795)	Air Filter Secondary..... A-5534 Air Filter Primary..... A-5535 Air Filter Set..... A-5573-S Fuel Filter..... FC-5516 Fuel Filter Secondary..... FC-55151 Fuel Filter Secondary..... FC-5515 Hydraulic Oil Filter..... H-5510 Hydraulic Oil Filter..... H-5506 Hydraulic Oil Filter..... HC-5504 Oil Filter Full Flow..... C-5510
518 II (SKIDDERS) S/N: 95U101-2500-UP	Air Filter Secondary..... A-5508 Air Filter Set..... A-5507-S Air Filter Primary..... A-5507				

MODEL/APPLICATION	SAKURA NO
CATERPILLAR	
525B (SKIDDERS) CAT 3126 (S/N: 3KZ1--00795)	
525B (SKIDDERS) CAT 3126 (S/N: 3KZ1--00874)	
Air Filter Set.....	A-5573-S
Air Filter Primary.....	A-5535
Air Filter Secondary.....	A-5534
Fuel Filter Secondary.....	FC-5515
Fuel Filter Secondary.....	FC-55151
Fuel Filter.....	FC-5516
Fuel Filter.....	FC-5508
Hydraulic Oil Filter.....	H-5510
Hydraulic Oil Filter.....	HC-5504
Oil Filter Full Flow.....	C-5510
525B (SKIDDERS) W/3126 ENG.	
Air Filter Primary.....	A-5535M
Air Filter Set.....	A-5573M-S
525C (SKIDDERS) CAT S/N: 5251-UP	
Fuel Filter.....	FC-5517
Hydraulic Oil Filter.....	HC-5504
Oil Filter Full Flow.....	C-5522
525C (SKIDDERS) CAT S/N: KHX304-UP	
Fuel Filter.....	FC-5517
Hydraulic Oil Filter.....	HC-5504
Oil Filter Full Flow.....	C-5522
527 (SKIDDERS) CAT 3304 TA	
Air Filter Secondary.....	A-5550
Air Filter Set.....	A-5549M-S
Air Filter Primary.....	A-5549M
Air Filter Primary.....	A-5549
Fuel Filter.....	F-5505
Hydraulic Oil Filter.....	H-5504
Hydraulic Oil Filter.....	H-5510
Oil Filter Full Flow.....	C-5510
527 (SKIDDERS) CAT 3304 (S/N: 2RS1-UP)	
Air Filter Primary.....	A-5549
Air Filter Primary.....	A-5549M
Air Filter Set.....	A-5549M-S
Air Filter Secondary.....	A-5550
Fuel Filter Secondary.....	FC-5507
Fuel Filter.....	F-5505
Hydraulic Oil Filter.....	H-5510
Oil Filter Full Flow.....	C-5510
527 (SKIDDERS) CAT 3304 (S/N: 3DS1-UP)	
Air Filter Secondary.....	A-5550
Air Filter Set.....	A-5549M-S
Air Filter Primary.....	A-5549M
Air Filter Primary.....	A-5549
Fuel Filter.....	F-5505
Fuel Filter Secondary.....	FC-5507
Hydraulic Oil Filter.....	H-5510

MODEL/APPLICATION	SAKURA NO
CATERPILLAR	
Oil Filter Full Flow.....	C-5510
527 (SKIDDERS) CAT 3304 (S/N: 4NS1-UP)	
Air Filter Primary.....	A-5549
Air Filter Primary.....	A-5549M
Air Filter Set.....	A-5549M-S
Air Filter Secondary.....	A-5550
Fuel Filter Secondary.....	FC-5507
Fuel Filter.....	F-5505
Hydraulic Oil Filter.....	H-5510
Oil Filter Full Flow.....	C-5510
528B (SKIDDERS) CAT (S/N: 08Z66000-UP)	
Fuel Filter Secondary.....	FC-5507
Oil Filter Full Flow.....	C-5522
528B (SKIDDERS) CAT (S/N: 6NC1-UP)	
Fuel Filter Secondary.....	FC-5507
Fuel Filter.....	FC-5509
Oil Filter Full Flow.....	C-5522
528B (SKIDDERS) S/N: 1PX1-UP	
Hydraulic Oil Filter.....	H-55270
528B (SKIDDERS) S/N: 7GX1-UP	
Hydraulic Oil Filter.....	H-55270
528B (SKIDDERS) S/N: 8531-UP	
Air Filter Primary.....	A-5549
Air Filter Primary.....	A-5549M
Air Filter Set.....	A-5549M-S
Air Filter Secondary.....	A-5550
Hydraulic Oil Filter.....	H-55270
Hydraulic Oil Filter.....	H-5504
528 (SKIDDERS) CAT 3306 (S/N: 51S1-UP) , 2005-UP	
Air Filter Secondary.....	A-5510
Air Filter Set.....	A-5522-S
Air Filter Primary.....	A-5509
Fuel Filter.....	F-5505
Fuel Filter Secondary.....	FC-5507
Hydraulic Oil Filter.....	H-5504
528 (SKIDDERS) CAT 3306 (S/N: 96C1-UP) , 2005-UP	
Air Filter Primary.....	A-5509
Air Filter Set.....	A-5522-S
Air Filter Secondary.....	A-5510
Fuel Filter Secondary.....	FC-5507
Fuel Filter.....	F-5505
Hydraulic Oil Filter.....	H-5504
528 (SKIDDERS) CAT 3306 (S/N: 97C1-UP) , 2005-UP	
Air Filter Secondary.....	A-5510
Air Filter Set.....	A-5522-S
Air Filter Primary.....	A-5509
Fuel Filter.....	F-5505
Fuel Filter Secondary.....	FC-5507
Hydraulic Oil Filter.....	H-5504

MODEL/APPLICATION	SAKURA NO
CATERPILLAR	
Hydraulic Oil Filter.....	H-5504
528 (SKIDDERS) S/N: 51S1-128	
Fuel Filter.....	F-5503
528 (SKIDDERS) S/N: 51S129-UP	
Air Filter Primary.....	A-5549
Air Filter Primary.....	A-5549M
Air Filter Set.....	A-5549M-S
Air Filter Secondary.....	A-5510
Air Filter Secondary.....	A-5550
Air Filter Set.....	A-5522-S
Air Filter Primary.....	A-5509
Fuel Filter Secondary.....	FC-5507
Hydraulic Oil Filter.....	H-5504
Oil Filter Full Flow.....	C-5510
528 (SKIDDERS) S/N: 78W1-UP	
Fuel Filter Secondary.....	FC-5507
Oil Filter Full Flow.....	C-5510
528 (SKIDDERS) S/N: 96C1-UP	
Air Filter Primary.....	A-5509
Air Filter Set.....	A-5522-S
Fuel Filter Secondary.....	FC-5507
Hydraulic Oil Filter.....	H-5504
Oil Filter Full Flow.....	C-5510
528 (SKIDDERS) S/N: 97C1-UP	
Air Filter Primary.....	A-5549M
Air Filter Primary.....	A-5549
Air Filter Set.....	A-5522-S
Air Filter Primary.....	A-5509
Air Filter Secondary.....	A-5550
Air Filter Secondary.....	A-5510
Air Filter Set.....	A-5549M-S
Fuel Filter Secondary.....	FC-5507
Hydraulic Oil Filter.....	H-5504
Oil Filter Full Flow.....	C-5510
528 (SKIDDERS) w/3306 Eng.	
Hydraulic Oil Filter.....	H-55320
530B (SKIDDERS) CAT (S/N: 08Z66000-UP)	
Fuel Filter Secondary.....	FC-5507
Oil Filter Full Flow.....	C-5522

Sakura Filter

ENGINE APPLICATION

MODEL/APPLICATION	SAKURA NO	MODEL/APPLICATION	SAKURA NO	MODEL/APPLICATION	SAKURA NO
CATERPILLAR		CATERPILLAR		CATERPILLAR	
530B (SKIDDERS) CAT (S/N: 6NC1-UP)		535B (SKIDDERS) CAT (S/N: 55K1-UP)		Air Filter Set.....	A-5573-S
Fuel Filter Secondary.....	FC-5507	Fuel Filter.....	FC-5516	Air Filter Primary.....	A-5535
Fuel Filter.....	FC-5509	Fuel Filter Secondary.....	FC-55151	Air Filter Secondary.....	A-5534
Oil Filter Full Flow.....	C-5522	Fuel Filter.....	FC-5508	Hydraulic Oil Filter.....	HC-5504
530B (SKIDDERS) S/N: 3PX1-UP		Fuel Filter Secondary.....	FC-5515	535B (SKIDDERS) W/3126 ENG.	
Hydraulic Oil Filter.....	H-55270	Oil Filter Full Flow.....	C-5522	Air Filter Primary.....	A-5535M
530B (SKIDDERS) S/N: 5BK1-UP		535B (SKIDDERS) CAT 3126 (S/N: AAE1-UP)		Air Filter Set.....	A-5573M-S
Air Filter Primary.....	A-5549	Air Filter Set.....	A-5573-S	535C (SKIDDERS) CAT S/N: 5351-UP	
Air Filter Primary.....	A-5549M	Air Filter Primary.....	A-5535	Fuel Filter.....	FC-5517
Air Filter Set.....	A-5549M-S	Air Filter Secondary.....	A-5534	Hydraulic Oil Filter.....	HC-5504
Air Filter Secondary.....	A-5550	Fuel Filter.....	FC-5508	Oil Filter Full Flow.....	C-5522
Hydraulic Oil Filter.....	H-55270	Fuel Filter Secondary.....	FC-55151	535C (SKIDDERS) CAT S/N: KHX1-UP	
Hydraulic Oil Filter.....	H-5504	Fuel Filter.....	FC-5516	Fuel Filter.....	FC-5517
530B (SKIDDERS) S/N: 7HX1-UP		Hydraulic Oil Filter.....	H-5510	Hydraulic Oil Filter.....	HC-5504
Hydraulic Oil Filter.....	H-55270	Hydraulic Oil Filter.....	HC-5504	Oil Filter Full Flow.....	C-5522
532 (FELLER BUNCHERS) CAT S/N: 5321-UP		Oil Filter Full Flow.....	C-5510	539 (LOG LOADERS) CAT 3126 DITA (S/N: 1PZ-UP)	
Air Filter.....	A-5584	535B (SKIDDERS) S/N: AAE1-557-UP		Air Filter Primary.....	A-5535
Air Filter Secondary.....	A-8651	Air Filter Secondary.....	A-5534	Air Filter Secondary.....	A-5534
Fuel Filter.....	FC-5517	Air Filter Primary.....	A-5535	Air Filter Set.....	A-5573-S
Hydraulic Oil Filter.....	H-5509	Air Filter Set.....	A-5573-S	Fuel Filter.....	FC-5516
Hydraulic Oil Filter.....	HC-55170	Hydraulic Oil Filter.....	H-5510	Fuel Filter Secondary.....	FC-5515
Hydraulic Oil Filter.....	HC-5801	Hydraulic Oil Filter.....	HC-5504	Fuel Filter Secondary.....	FC-55151
532 (FELLER BUNCHERS) CAT S/N: THX1-UP		Hydraulic Oil Filter.....	H-5506	Fuel Filter.....	FC-5508
Air Filter Secondary.....	A-8651	535B (SKIDDERS) S/N: AAE558-561-UP		Hydraulic Oil Filter.....	HC-5505
Air Filter.....	A-5584	Hydraulic Oil Filter.....	H-5510	Oil Filter Full Flow.....	C-5510
Fuel Filter.....	FC-5517	Hydraulic Oil Filter.....	H-5506	539 (LOG LOADERS) W/3126 ENG.	
Hydraulic Oil Filter.....	HC-5801	Hydraulic Oil Filter.....	HC-5504	Air Filter Set.....	A-5573M-S
Hydraulic Oil Filter.....	HC-55170	535B (SKIDDERS) S/N: AAE562-562-UP		Air Filter Primary.....	A-5535M
Hydraulic Oil Filter.....	H-5509	Hydraulic Oil Filter.....	HC-5504	541 (FELLER BUNCHERS) CAT S/N: 5411-UP	
533 (FELLER BUNCHERS) CAT 3126 (S/N: CDR1-UP)		535B (SKIDDERS) S/N: AAE563-567-UP		Air Filter.....	A-5584
Air Filter Primary.....	A-5558	Hydraulic Oil Filter.....	HC-5504	Air Filter Secondary.....	A-8651
Air Filter Secondary.....	A-5559	Hydraulic Oil Filter.....	H-5506	Fuel Filter.....	FC-5517
Fuel Filter.....	FC-5516	Hydraulic Oil Filter.....	H-5510	Hydraulic Oil Filter.....	H-5509
Fuel Filter Secondary.....	FC-5515	535B (SKIDDERS) S/N: AAE568-582-UP		Hydraulic Oil Filter.....	HC-55170
Fuel Filter Secondary.....	FC-55151	Hydraulic Oil Filter.....	H-5510	Hydraulic Oil Filter.....	HC-5801
Fuel Filter.....	FC-5508	Hydraulic Oil Filter.....	H-5506	541 (FELLER BUNCHERS) CAT S/N: THX1-UP	
Hydraulic Oil Filter.....	HC-55300	Hydraulic Oil Filter.....	HC-5504	Air Filter Secondary.....	A-8651
Oil Filter Full Flow.....	C-5510	535B (SKIDDERS) S/N: AAE583-708-UP		Air Filter.....	A-5584
535B (SKIDDERS) CAT 3126 DITA		Hydraulic Oil Filter.....	HC-5504	Fuel Filter.....	FC-5517
Air Filter Secondary.....	A-5534	535B (SKIDDERS) S/N: AAE709-746-UP		Hydraulic Oil Filter.....	HC-5801
Air Filter Primary.....	A-5535	Hydraulic Oil Filter.....	H-5510	Hydraulic Oil Filter.....	HC-55170
Air Filter Set.....	A-5573-S	Hydraulic Oil Filter.....	HC-5504	Hydraulic Oil Filter.....	H-5509
Fuel Filter.....	FC-5508	535B (SKIDDERS) S/N: AAE747-778-UP		541 (FELLER BUNCHERS) CAT 3126 (S/N: ASJ1-UP)	
Fuel Filter Secondary.....	FC-55151	Hydraulic Oil Filter.....	HC-5504	Air Filter Primary.....	A-5558
Fuel Filter.....	FC-5516	535B (SKIDDERS) S/N: AAE779-UP		Air Filter Secondary.....	A-5559
Fuel Filter Secondary.....	FC-5515	Hydraulic Oil Filter.....	HC-5504	Fuel Filter.....	FC-5516
Hydraulic Oil Filter.....	HC-5504	535B (SKIDDERS) S/N: AAE779-UP		Fuel Filter Secondary.....	FC-55151
Oil Filter Full Flow.....	C-5510	Hydraulic Oil Filter.....	HC-5504	Fuel Filter Secondary.....	FC-5515
		535B (SKIDDERS) S/N: AAE779-UP		Fuel Filter.....	FC-5508
		Hydraulic Oil Filter.....	HC-5504	Hydraulic Oil Filter.....	HC-55300

Sakura Filter

ENGINE APPLICATION

MODEL/APPLICATION	SAKURA NO	MODEL/APPLICATION	SAKURA NO	MODEL/APPLICATION	SAKURA NO
CATERPILLAR		CATERPILLAR		CATERPILLAR	
543 (FELLER BUNCHERS) CAT 3126 (S/N: ASJ1-UP) Oil Filter Full Flow..... C-5510		Air Filter Primary..... A-5535M Air Filter Set..... A-5573M-S		Air Filter Primary..... A-5549M Air Filter Set..... A-5549M-S Hydraulic Oil Filter..... HC-5504	
545 (SKIDDERS) CAT (S/N: 6NC1-UP) Fuel Filter..... FC-5509 Fuel Filter Secondary..... FC-5507 Oil Filter Full Flow..... C-5522		545C (SKIDDERS) CAT S/N: 5451-UP Fuel Filter..... FC-5517 Hydraulic Oil Filter..... HC-5504 Oil Filter Full Flow..... C-5522		55 (TRACTORS) S/N: 7DM1-UP Air Filter Primary..... A-5549 Air Filter Set..... A-5549M-S Air Filter Primary..... A-5549M Air Filter Secondary..... A-5550 Hydraulic Oil Filter..... HC-5504 Hydraulic Oil Filter..... HC-5506 Hydraulic Oil Filter..... HC-5512 Hydraulic Oil Filter..... HC-5503 Oil Filter Full Flow..... C-5522 Oil Filter Full Flow..... C-5510	
545 (SKIDDERS) CAT 3306 (S/N: 2FZ1-UP) Air Filter Secondary..... A-5534 Air Filter Primary..... A-5535 Air Filter Set..... A-5573-S Fuel Filter..... F-5505 Fuel Filter Secondary..... FC-5507 Hydraulic Oil Filter..... H-5506 Hydraulic Oil Filter..... H-5510 Hydraulic Oil Filter..... HC-5504 Oil Filter Full Flow..... C-5510		545C (SKIDDERS) CAT S/N: KHX1-UP Fuel Filter..... FC-5517 Hydraulic Oil Filter..... HC-5504 Oil Filter Full Flow..... C-5522		55 (TRACTORS) S/N: 7T21-UP Air Filter Primary..... A-5549 Air Filter Secondary..... A-5550 Air Filter Primary..... A-5549M Air Filter Set..... A-5549M-S Hydraulic Oil Filter..... HC-5504	
545 (SKIDDERS) S/N: 2FZ1-431-UP Air Filter Set..... A-5573-S Air Filter Primary..... A-5535 Air Filter Secondary..... A-5534 Hydraulic Oil Filter..... H-5510 Hydraulic Oil Filter..... H-5506 Hydraulic Oil Filter..... HC-5504		550 (FORAGE HARVESTERS) CAT 3126 (S/N: 7ZM1-UP) Air Filter Secondary..... A-5550 Air Filter Set..... A-5549M-S Air Filter Primary..... A-5549M Air Filter Primary..... A-5549 Fuel Filter..... FC-5516 Fuel Filter Secondary..... FC-5515 Fuel Filter Secondary..... FC-55151 Hydraulic Oil Filter..... HC-5801 Oil Filter Full Flow..... C-5510		55 (TRACTORS) S/N: AEN1-UP Air Filter Set..... A-5549M-S Air Filter Primary..... A-5549M Air Filter Secondary..... A-5550 Air Filter Primary..... A-5549 Hydraulic Oil Filter..... HC-5504	
545 (SKIDDERS) S/N: 2FZ432-432-UP Air Filter Set..... A-5573-S Air Filter Secondary..... A-5534 Air Filter Primary..... A-5535 Hydraulic Oil Filter..... H-5506 Hydraulic Oil Filter..... H-5510 Hydraulic Oil Filter..... HC-5504		55 (TRACTORS) CAT (S/N: 55K1-UP) Fuel Filter Secondary..... FC-55151 Fuel Filter Secondary..... FC-5515 Fuel Filter..... FC-5516 Fuel Filter..... FC-5508 Oil Filter Full Flow..... C-5522		55 (TRACTORS) S/N: 2EJ1-UP Hydraulic Oil Filter..... H-5501	
545 (SKIDDERS) S/N: 2FZ433-433-UP Air Filter Set..... A-5573-S Air Filter Primary..... A-5535 Air Filter Secondary..... A-5534 Hydraulic Oil Filter..... HC-5504		55 (TRACTORS) S/N: 2CC1-UP Hydraulic Oil Filter..... H-5501		550B (FORAGE HARVESTERS) CAT 3056E (S/N: SAW1-UP) Air Filter Secondary..... A-5550 Air Filter Set..... A-5549M-S Air Filter Primary..... A-5549M Air Filter Primary..... A-5549 Hydraulic Oil Filter..... HC-5801 Oil Filter Full Flow..... C-5101	
545 (SKIDDERS) S/N: 2FZ434-437-UP Air Filter Secondary..... A-5534 Air Filter Primary..... A-5535 Air Filter Set..... A-5573-S Hydraulic Oil Filter..... H-5510 Hydraulic Oil Filter..... H-5506 Hydraulic Oil Filter..... HC-5504		55 (TRACTORS) S/N: 2EJ1-UP Hydraulic Oil Filter..... H-5501		551 (FELLER BUNCHERS) CAT S/N: 5511-UP Air Filter..... A-5584 Air Filter Secondary..... A-8651 Fuel Filter..... FC-5517 Hydraulic Oil Filter..... H-5509 Hydraulic Oil Filter..... HC-5801 Hydraulic Oil Filter..... HC-55170	
545 (SKIDDERS) S/N: 2FZ438-UP Air Filter Set..... A-5573-S Air Filter Primary..... A-5535 Air Filter Secondary..... A-5534 Hydraulic Oil Filter..... HC-5504		55 (TRACTORS) S/N: 5DK1-1849-UP Air Filter Set..... A-5549M-S Air Filter Primary..... A-5549M Air Filter Secondary..... A-5550 Air Filter Primary..... A-5549 Hydraulic Oil Filter..... HC-5504 Hydraulic Oil Filter..... HC-5503 Hydraulic Oil Filter..... HC-5512 Hydraulic Oil Filter..... HC-5506		551 (FELLER BUNCHERS) CAT S/N: 5521-UP Air Filter Secondary..... A-8651 Air Filter..... A-5584 Fuel Filter..... FC-5517 Hydraulic Oil Filter..... HC-55170 Hydraulic Oil Filter..... HC-5801 Hydraulic Oil Filter..... H-5509	
545 (SKIDDERS) S/N: 2FZ438-UP Air Filter Set..... A-5573-S Air Filter Primary..... A-5535 Air Filter Secondary..... A-5534 Hydraulic Oil Filter..... HC-5504		55 (TRACTORS) S/N: 6NN1-UP Air Filter Primary..... A-5549 Air Filter Secondary..... A-5550		551 (FELLER BUNCHERS) CAT S/N: THX1-UP Air Filter..... A-5584 Air Filter Secondary..... A-8651 Fuel Filter..... FC-5517	
545 (SKIDDERS) w/3306 Eng.					

MODEL/APPLICATION	SAKURA NO
CATERPILLAR	
551 (<i>FELLER BUNCHERS</i>) CAT S/N: THX1-UP	
Hydraulic Oil Filter.....	H-5509
Hydraulic Oil Filter.....	HC-5801
Hydraulic Oil Filter.....	HC-55170
554 (<i>FORWARDERS</i>) CAT 7B31-UP	
Air Filter Primary.....	A-56731
Air Filter Set.....	A-56731-S
Air Filter Secondary.....	A-56741
554 (<i>FORWARDERS</i>) S/N: 1A1-UP	
Air Filter Secondary.....	A-5540
Air Filter Primary.....	A-5541
Air Filter Primary.....	A-5541M
Air Filter Set.....	A-5541M-S
Air Filter Primary.....	A-76231
Hydraulic Oil Filter.....	HC-5504
Oil Filter Full Flow.....	C-5102
560B (<i>HANDLER TELESCOPIC</i>) CAT 3056E (S/N: TRA1-UP)	
Air Filter Primary.....	A-5549
Air Filter Primary.....	A-5549M
Air Filter Set.....	A-5549M-S
Air Filter Secondary.....	A-5550
Hydraulic Oil Filter.....	HC-5801
Oil Filter Full Flow.....	C-5101
561M (<i>PIPE LAYERS</i>) CAT 3116	
Air Filter Set.....	A-5568-S
Air Filter Secondary.....	A-5567
Air Filter Primary.....	A-5566
Fuel Filter.....	FC-5516
Fuel Filter Secondary.....	FC-5515
Fuel Filter Secondary.....	FC-55151
Hydraulic Oil Filter.....	H-5504
Oil Filter Full Flow.....	C-5510
561N (<i>PIPE LAYERS</i>) w/3126B Eng.	
Hydraulic Oil Filter.....	HC-55280
561B (<i>PIPE LAYERS</i>) S/N: 62A1-UP	
Air Filter Secondary.....	A-5508
Air Filter Set.....	A-55071-S
Air Filter Primary.....	A-5507
Air Filter Set.....	A-5507-S
Air Filter Primary.....	A-5566
Air Filter Secondary.....	A-5567
Air Filter Set.....	A-5568-S
Fuel Filter.....	F-5501
Hydraulic Oil Filter.....	H-5504
Oil Filter Full Flow.....	O-5505
Oil Filter Full Flow.....	O-5502
561C (<i>PIPE LAYERS</i>)	
Fuel Filter.....	F-5503

MODEL/APPLICATION	SAKURA NO
CATERPILLAR	
561C (<i>PIPE LAYERS</i>) S/N: 54X1-UP	
Air Filter Primary.....	A-5509
Air Filter Primary.....	A-5549M
Air Filter Primary.....	A-5549
Air Filter Set.....	A-5522-S
Air Filter Secondary.....	A-5510
Air Filter Secondary.....	A-5550
Air Filter Set.....	A-5549M-S
Fuel Filter Secondary.....	FC-5507
Fuel Filter.....	F-5501
Hydraulic Oil Filter.....	H-5508
Hydraulic Oil Filter.....	H-5502
Hydraulic Oil Filter.....	H-5504
Oil Filter Full Flow.....	O-5502
Oil Filter Full Flow.....	C-5510
561C (<i>PIPE LAYERS</i>) S/N: 85H1-UP	
Air Filter Primary.....	A-5509
Air Filter Set.....	A-5549M-S
Air Filter Secondary.....	A-5550
Air Filter Secondary.....	A-5510
Air Filter Set.....	A-5522-S
Air Filter Primary.....	A-5549
Air Filter Primary.....	A-5549M
Fuel Filter Secondary.....	FC-5507
Fuel Filter.....	F-5501
Hydraulic Oil Filter.....	H-5504
Hydraulic Oil Filter.....	H-5508
Hydraulic Oil Filter.....	H-5502
Oil Filter Full Flow.....	O-5502
Oil Filter Full Flow.....	C-5510
561C (<i>PIPE LAYERS</i>) S/N: 92J1-362	
Air Filter Primary.....	A-5549M
Air Filter Primary.....	A-5549
Air Filter Set.....	A-5522-S
Air Filter Secondary.....	A-5510
Air Filter Secondary.....	A-5550
Air Filter Set.....	A-5549M-S
Air Filter Primary.....	A-5509
Fuel Filter Secondary.....	FC-5507
Hydraulic Oil Filter.....	H-5504
Oil Filter Full Flow.....	O-5502
561C (<i>PIPE LAYERS</i>) S/N: 92J1-UP	
Air Filter Primary.....	A-5509
Air Filter Set.....	A-5549M-S
Air Filter Secondary.....	A-5550
Air Filter Secondary.....	A-5510
Air Filter Set.....	A-5522-S
Air Filter Primary.....	A-5549
Air Filter Primary.....	A-5549M
Fuel Filter Secondary.....	FC-5507
Fuel Filter.....	F-5501
Hydraulic Oil Filter.....	H-5508
Hydraulic Oil Filter.....	H-5504
Hydraulic Oil Filter.....	H-5502
Oil Filter Full Flow.....	O-5502

MODEL/APPLICATION	SAKURA NO
CATERPILLAR	
Oil Filter Full Flow.....	C-5510
561C (<i>PIPE LAYERS</i>) S/N: 92J363-UP	
Air Filter Primary.....	A-5549M
Air Filter Primary.....	A-5549
Air Filter Set.....	A-5522-S
Air Filter Secondary.....	A-5510
Air Filter Secondary.....	A-5550
Air Filter Set.....	A-5549M-S
Air Filter Primary.....	A-5509
Fuel Filter Secondary.....	FC-5507
Hydraulic Oil Filter.....	H-5504
Oil Filter Full Flow.....	C-5510
561C (<i>PIPE LAYERS</i>) w/3306 Eng. (S/N 92J)	
Hydraulic Oil Filter.....	H-55320
561D (<i>PIPE LAYERS</i>)	
Fuel Filter.....	F-5503
564 (<i>FORWARDERS</i>) CAT S/N: CPT1-UP	
Air Filter Secondary.....	A-8578
Air Filter Primary.....	AS-8577
Fuel Filter.....	FC-5517
Hydraulic Oil Filter.....	HC-5504
Hydraulic Oil Filter.....	HC-5801
Oil Filter Full Flow.....	C-5522
Oil Filter Full Flow.....	C-5101
564 (<i>FORWARDERS</i>) CAT S/N: KBN1-UP	
Air Filter Primary.....	AS-8577
Air Filter Secondary.....	A-8578
Fuel Filter.....	FC-5517
Hydraulic Oil Filter.....	HC-5801
Hydraulic Oil Filter.....	HC-5504
Oil Filter Full Flow.....	C-5101
Oil Filter Full Flow.....	C-5522
570 (<i>FORAGE HARVESTERS</i>) CAT 3126 (S/N: 4XR1-UP)	
Air Filter Primary.....	A-5549
Air Filter Primary.....	A-5549M
Air Filter Set.....	A-5549M-S
Air Filter Secondary.....	A-5550
Fuel Filter.....	FC-5516
Fuel Filter Secondary.....	FC-55151
Fuel Filter Secondary.....	FC-5515
Hydraulic Oil Filter.....	HC-5801
Oil Filter Full Flow.....	C-5510
570B (<i>FORAGE HARVESTERS</i>) CAT 3126B (S/N: CKG1-UP)	
Air Filter Secondary.....	A-5550
Air Filter Set.....	A-5549M-S
Air Filter Primary.....	A-5549M
Air Filter Primary.....	A-5549
Fuel Filter.....	FC-5517
Hydraulic Oil Filter.....	HC-5801
Oil Filter Full Flow.....	C-5510

MODEL/APPLICATION	SAKURA NO	MODEL/APPLICATION	SAKURA NO	MODEL/APPLICATION	SAKURA NO
CATERPILLAR		CATERPILLAR		CATERPILLAR	
571A <i>(PIPE LAYERS)</i> S/N: 64A1-151 Fuel Filter..... F-5501 Hydraulic Oil Filter..... H-5504 Oil Filter Full Flow..... O-5503		Air Filter Set..... A-5522-S Air Filter Set..... A-5549M-S Air Filter Primary..... A-5549M Air Filter Secondary..... A-5550 Fuel Filter Secondary..... FC-5507 Hydraulic Oil Filter..... H-5502 Hydraulic Oil Filter..... H-5508 Hydraulic Oil Filter..... H-5503 Oil Filter Full Flow..... C-5510		Air Filter Primary..... A-5535 Air Filter Secondary..... A-5534 Fuel Filter..... FC-5509 Hydraulic Oil Filter..... H-55280 Hydraulic Oil Filter..... H-5510 Hydraulic Oil Filter..... H-5526	
571A <i>(PIPE LAYERS)</i> S/N: 64A152-UP Air Filter Primary..... A-5514 Air Filter Set..... A-5514-S Fuel Filter..... F-5501 Hydraulic Oil Filter..... H-5504 Oil Filter Full Flow..... O-5503		571G <i>(PIPE LAYERS)</i> S/N: 16W1-UP Air Filter Set..... A-5549M-S Air Filter Primary..... A-5549M Air Filter Primary..... A-5549 Air Filter Primary..... A-5509 Air Filter Secondary..... A-5522 Air Filter Set..... A-5522-S Air Filter Secondary..... A-5550 Fuel Filter Secondary..... FC-5507 Hydraulic Oil Filter..... H-5508 Hydraulic Oil Filter..... H-5502 Hydraulic Oil Filter..... H-5503 Oil Filter Full Flow..... C-5510		572E <i>(PIPE LAYERS)</i> S/N: 65A1-150 Fuel Filter..... F-5501 Hydraulic Oil Filter..... H-5504 Oil Filter Full Flow..... O-5505 Oil Filter Full Flow..... O-5503	
571F <i>(PIPE LAYERS)</i> Fuel Filter..... F-5503		571G <i>(PIPE LAYERS)</i> S/N: 52D1-UP Air Filter Primary..... A-5549 Air Filter Primary..... A-5549M Air Filter Set..... A-5549M-S Air Filter Secondary..... A-5550		572E <i>(PIPE LAYERS)</i> S/N: 65A151-175 Fuel Filter..... F-5501 Hydraulic Oil Filter..... H-5504 Oil Filter Full Flow..... O-5503 Oil Filter Full Flow..... O-5505	
571F <i>(PIPE LAYERS)</i> S/N: 16W1-UP Air Filter Secondary..... A-5550 Air Filter Primary..... A-5549M Air Filter Set..... A-5549M-S Air Filter Set..... A-5522-S Air Filter Secondary..... A-5522 Air Filter Primary..... A-5509 Air Filter Primary..... A-5549 Fuel Filter Secondary..... FC-5507 Hydraulic Oil Filter..... H-5503 Hydraulic Oil Filter..... H-5502 Hydraulic Oil Filter..... H-5508 Oil Filter Full Flow..... C-5510		571R <i>(PIPE LAYERS)</i> S/N: 52D1-UP Air Filter Primary..... A-5549 Air Filter Primary..... A-5549M Air Filter Set..... A-5549M-S Air Filter Secondary..... A-5550		572E <i>(PIPE LAYERS)</i> S/N: 65A176-UP Air Filter Set..... A-5514-S Air Filter Primary..... A-5514 Fuel Filter..... F-5501 Hydraulic Oil Filter..... H-5504 Oil Filter Full Flow..... O-5505 Oil Filter Full Flow..... O-5503	
571F <i>(PIPE LAYERS)</i> S/N: 95N1-190 Air Filter Primary..... A-5549 Air Filter Primary..... A-5509 Air Filter Secondary..... A-5522 Air Filter Set..... A-5522-S Air Filter Set..... A-5549M-S Air Filter Primary..... A-5549M Air Filter Secondary..... A-5550 Fuel Filter Secondary..... FC-5507 Hydraulic Oil Filter..... H-5503 Hydraulic Oil Filter..... H-5508 Oil Filter Full Flow..... C-5510		572R <i>(PIPE LAYERS)</i> CAT 3306 (S/N: 2HZ-UP) Air Filter Set..... A-5573-S Air Filter Secondary..... A-5534 Air Filter Primary..... A-5535 Fuel Filter..... F-5505 Fuel Filter Secondary..... FC-5507 Hydraulic Oil Filter..... H-5503 Oil Filter Full Flow..... C-5510		572F <i>(PIPE LAYERS)</i> S/N: 96N1-163 Air Filter Set..... A-5522-S Air Filter Secondary..... A-5522 Air Filter Primary..... A-5549M Air Filter Primary..... A-5509 Air Filter Set..... A-5549M-S Air Filter Secondary..... A-5550 Air Filter Primary..... A-5549 Fuel Filter Secondary..... FC-5507 Hydraulic Oil Filter..... H-5503 Hydraulic Oil Filter..... H-5502 Hydraulic Oil Filter..... H-5508 Oil Filter Full Flow..... C-5510	
571F <i>(PIPE LAYERS)</i> S/N: 95N191-UP Air Filter Secondary..... A-5550 Air Filter Primary..... A-5549M Air Filter Set..... A-5549M-S Air Filter Set..... A-5522-S Air Filter Secondary..... A-5522 Air Filter Primary..... A-5509 Air Filter Primary..... A-5549 Fuel Filter Secondary..... FC-5507 Hydraulic Oil Filter..... H-5503 Oil Filter Full Flow..... C-5510		572R <i>(PIPE LAYERS)</i> w/3176C Eng. Air Filter Primary..... A-5535M Air Filter Set..... A-5573M-S		572F <i>(PIPE LAYERS)</i> S/N: 96N164-UP Air Filter Primary..... A-5549 Air Filter Secondary..... A-5550 Air Filter Set..... A-5549M-S Air Filter Primary..... A-5509 Air Filter Primary..... A-5549M Air Filter Secondary..... A-5522 Air Filter Set..... A-5522-S Fuel Filter Secondary..... FC-5507 Hydraulic Oil Filter..... H-5503 Hydraulic Oil Filter..... H-5508 Hydraulic Oil Filter..... H-5502 Oil Filter Full Flow..... C-5510	
571F <i>(PIPE LAYERS)</i> S/N: 95N1-UP Air Filter Primary..... A-5549 Air Filter Primary..... A-5509 Air Filter Secondary..... A-5522		572R II <i>(PIPE LAYERS)</i> CAT S/N: 7ZR6828-UP Air Filter Secondary..... A-5534 Air Filter Primary..... A-5535 Air Filter Set..... A-5573-S Fuel Filter..... FC-5509 Hydraulic Oil Filter..... H-5510 Hydraulic Oil Filter..... H-55280 Hydraulic Oil Filter..... H-5526		572F <i>(PIPE LAYERS)</i> S/N: 96N164-UP Air Filter Primary..... A-5549 Air Filter Secondary..... A-5550 Air Filter Set..... A-5549M-S Air Filter Primary..... A-5509 Air Filter Primary..... A-5549M Air Filter Secondary..... A-5522 Air Filter Set..... A-5522-S Fuel Filter Secondary..... FC-5507 Hydraulic Oil Filter..... H-5503 Hydraulic Oil Filter..... H-5508 Hydraulic Oil Filter..... H-5502 Oil Filter Full Flow..... C-5510	
		572R II <i>(PIPE LAYERS)</i> CAT S/N: DSC302-UP Air Filter Set..... A-5573-S			

MODEL/APPLICATION	SAKURA NO
CATERPILLAR	
572G (PIPE LAYERS) S/N: 40U1-UP	
Air Filter Primary.....	A-5509
Air Filter Set.....	A-5522-S
Air Filter Secondary.....	A-5522
Air Filter Primary.....	A-5549M
Air Filter Primary.....	A-5549
Air Filter Secondary.....	A-5550
Air Filter Set.....	A-5549M-S
Fuel Filter Secondary.....	FC-5507
Hydraulic Oil Filter.....	H-5508
Hydraulic Oil Filter.....	H-5502
Hydraulic Oil Filter.....	H-5503
Oil Filter Full Flow.....	C-5510
574 (FORWARDERS) CAT 3126 (S/N: 1FM-UP)	
Air Filter Secondary.....	A-8578
Fuel Filter.....	FC-5516
Fuel Filter Secondary.....	FC-5515
Fuel Filter Secondary.....	FC-55151
Hydraulic Oil Filter.....	HC-5504
Oil Filter Full Flow.....	C-5510
574B (FORWARDERS) CAT 3056E (S/N: CZZ1-UP)	
Air Filter Secondary.....	A-8578
Air Filter Primary.....	AS-8577
Hydraulic Oil Filter.....	HC-5504
Hydraulic Oil Filter.....	HC-5801
Oil Filter Full Flow.....	C-5101
578 (PIPE LAYERS) S/N: 8HB1-UP	
Air Filter Set.....	A-5573-S
Air Filter Secondary.....	A-5534
Air Filter Primary.....	A-5535
Fuel Filter.....	FC-5509
Hydraulic Oil Filter.....	H-5510
Oil Filter Full Flow.....	C-5516
578 (PIPE LAYERS) S/N: 9CA1-UP	
Hydraulic Oil Filter.....	H-5510
578 (PIPE LAYERS) w/3406 Eng.	
Air Filter Set.....	A-5573M-S
Air Filter Primary.....	A-5535M
580 (FORAGE HARVESTERS) CAT 3126 (S/N: 7CN1-UP)	
Air Filter Set.....	A-5549M-S
Air Filter Secondary.....	A-5550
Air Filter Primary.....	A-5549
Air Filter Primary.....	A-5549M
Fuel Filter Secondary.....	FC-55151
Fuel Filter Secondary.....	FC-5515
Fuel Filter.....	FC-5516
Hydraulic Oil Filter.....	HC-5801
Oil Filter Full Flow.....	C-5510
580B (FORAGE HARVESTERS) CAT 3126B (S/N: CLT1-UP)	

MODEL/APPLICATION	SAKURA NO
CATERPILLAR	
Air Filter Primary.....	A-5549M
Air Filter Primary.....	A-5549
Air Filter Secondary.....	A-5550
Air Filter Set.....	A-5549M-S
Fuel Filter.....	FC-5517
Hydraulic Oil Filter.....	HC-5801
Oil Filter Full Flow.....	C-5510
583 (PIPE LAYERS) S/N: 16A-16A	
Fuel Filter.....	F-5501
Hydraulic Oil Filter.....	H-55270
Hydraulic Oil Filter.....	H-5504
Oil Filter Full Flow.....	O-5505
Oil Filter Full Flow.....	O-5501
583 (PIPE LAYERS) S/N: 21A1-UP	
Fuel Filter.....	F-5501
Oil Filter Full Flow.....	O-5502
Oil Filter Full Flow.....	O-5505
583 (PIPE LAYERS) S/N: 61A1-119	
Fuel Filter.....	F-5501
Hydraulic Oil Filter.....	H-5503
Hydraulic Oil Filter.....	H-5504
Oil Filter Full Flow.....	O-5505
Oil Filter Full Flow.....	O-5501
583 (PIPE LAYERS) S/N: 61A120-UP	
Air Filter Set.....	A-5515-S
Air Filter Secondary.....	A-5528
Air Filter Primary.....	A-5515
Fuel Filter.....	F-5501
Hydraulic Oil Filter.....	H-5503
Hydraulic Oil Filter.....	H-5504
Hydraulic Oil Filter.....	H-5508
Hydraulic Oil Filter.....	H-5503
Oil Filter Full Flow.....	O-5502
583 (PIPE LAYERS) S/N: 61A199-UP	
Air Filter Secondary.....	A-5528
Air Filter Primary.....	A-5515
Air Filter Set.....	A-5515-S
Fuel Filter.....	F-5501
Hydraulic Oil Filter.....	H-5503
Hydraulic Oil Filter.....	H-5504
Hydraulic Oil Filter.....	H-5508
Oil Filter Full Flow.....	O-5502
Oil Filter Full Flow.....	O-5505
583 (PIPE LAYERS) S/N: 61A120-UP	
Air Filter Set.....	A-5515-S
Air Filter Secondary.....	A-5528
Air Filter Primary.....	A-5515
Air Filter Set.....	A-5515-S
Fuel Filter.....	F-5501
Hydraulic Oil Filter.....	H-5503
Hydraulic Oil Filter.....	H-5504
Hydraulic Oil Filter.....	H-5508
Oil Filter Full Flow.....	O-5505
Oil Filter Full Flow.....	O-5501
583R (PIPE LAYERS) CAT 3406C	
Air Filter Set.....	A-5555-S
Air Filter Primary.....	A-5555
Air Filter Secondary.....	A-5556
Fuel Filter.....	FC-5509
Hydraulic Oil Filter.....	H-5510
583T (PIPE LAYERS) CAT S/N: CMX1-UP	
Air Filter Secondary.....	A-5556

MODEL/APPLICATION	SAKURA NO
CATERPILLAR	
Air Filter Primary.....	A-5555
Air Filter Set.....	A-5555-S
Fuel Filter.....	FC-5517
Hydraulic Oil Filter.....	H-55280
Hydraulic Oil Filter.....	H-5526
Hydraulic Oil Filter.....	H-5506
Hydraulic Oil Filter.....	HC-5504
Hydraulic Oil Filter.....	H-5503
583T (PIPE LAYERS) CAT S/N: LHX1-UP	
Air Filter Set.....	A-5555-S
Air Filter Primary.....	A-5555
Air Filter Secondary.....	A-5556
Fuel Filter.....	FC-5517
Hydraulic Oil Filter.....	H-5503
Hydraulic Oil Filter.....	HC-5504
Hydraulic Oil Filter.....	H-5506
Hydraulic Oil Filter.....	H-5526
Hydraulic Oil Filter.....	H-55280
583H (PIPE LAYERS) S/N: 61A120-UP	
Air Filter Set.....	A-5515-S
Air Filter Secondary.....	A-5528
Air Filter Primary.....	A-5515
Fuel Filter.....	F-5501
Hydraulic Oil Filter.....	H-5503
Hydraulic Oil Filter.....	H-5504
Hydraulic Oil Filter.....	H-5508
Hydraulic Oil Filter.....	H-5502
Oil Filter Full Flow.....	O-5502
583H (PIPE LAYERS) S/N: 61A1-UP	
Air Filter Secondary.....	A-5528
Air Filter Set.....	A-5515-S
Air Filter Primary.....	A-5515
Fuel Filter.....	F-5501
Hydraulic Oil Filter.....	H-5502
Hydraulic Oil Filter.....	H-5508
Hydraulic Oil Filter.....	H-5504
Hydraulic Oil Filter.....	H-5503
Oil Filter Full Flow.....	O-5502
583K (PIPE LAYERS) S/N: 78V1-UP	
Air Filter Primary.....	A-5535
Air Filter Secondary.....	A-5534
Air Filter Secondary.....	A-5502
Air Filter Primary.....	A-5501
Air Filter Set.....	A-5573-S
Fuel Filter Secondary.....	FC-5507
Hydraulic Oil Filter.....	H-5502
Hydraulic Oil Filter.....	H-5508
Hydraulic Oil Filter.....	H-5503
Oil Filter Full Flow.....	C-5516
587T (PIPE LAYERS) CAT S/N: FAT1-UP	
Air Filter Set.....	A-5555-S
Air Filter Primary.....	A-5555
Air Filter Secondary.....	A-5556
Fuel Filter.....	FC-5517

MODEL/APPLICATION	SAKURA NO	MODEL/APPLICATION	SAKURA NO	MODEL/APPLICATION	SAKURA NO
CATERPILLAR		CATERPILLAR		CATERPILLAR	
587T <i>(PIPE LAYERS)</i> CAT S/N: FAT1-UP Hydraulic Oil Filter..... H-5526 Hydraulic Oil Filter..... H-55280 Hydraulic Oil Filter..... HC-5504		Air Filter Secondary..... A-5526 Air Filter Primary..... A-5557 Air Filter Set..... A-5557-S Fuel Filter..... F-5501 Hydraulic Oil Filter..... H-5503 Oil Filter Full Flow..... O-5505 Oil Filter Full Flow..... O-5503		613C <i>(SCRAPERS)</i> CAT 3208 (S/N: 93X1-UP) Air Filter Primary..... A-5543 Air Filter Set..... A-5544-S Fuel Filter Secondary..... FC-5507 Fuel Filter..... F-5505 Hydraulic Oil Filter..... H-5503 Hydraulic Oil Filter..... H-5504 Oil Filter Full Flow..... C-5519	
587T <i>(PIPE LAYERS)</i> CAT S/N: LHX1-UP Air Filter Secondary..... A-5556 Air Filter Primary..... A-5555 Air Filter Set..... A-5555-S Fuel Filter..... FC-5517 Hydraulic Oil Filter..... HC-5504 Hydraulic Oil Filter..... H-55280 Hydraulic Oil Filter..... H-5526		594G <i>(PIPE LAYERS)</i> S/N: 62H1-UP Air Filter Secondary..... A-5526 Air Filter Set..... A-5557-S Air Filter Primary..... A-5557 Fuel Filter..... F-5501 Hydraulic Oil Filter..... H-5503 Oil Filter Full Flow..... O-5503 Oil Filter Full Flow..... O-5505		613C SERIES II <i>(SCRAPERS)</i> CAT 3116T (S/N: 8LJ1-UP) Air Filter Primary..... A-5543 Air Filter Set..... A-5544-S Air Filter Primary..... A-5558 Air Filter Secondary..... A-5559 Fuel Filter..... FC-5516 Fuel Filter Secondary..... FC-5515 Fuel Filter Secondary..... FC-55151 Hydraulic Oil Filter..... H-5503 Hydraulic Oil Filter..... H-5504 Hydraulic Oil Filter..... H-55270 Hydraulic Oil Filter..... H-5526 Hydraulic Oil Filter..... H-55280 Oil Filter Full Flow..... C-5510	
587R <i>(PIPE LAYERS)</i> CAT S/N: 41Z23000-UP Air Filter Secondary..... A-5556 Air Filter Primary..... A-5555 Air Filter Set..... A-5555-S Fuel Filter..... FC-5509 Hydraulic Oil Filter..... H-55280 Hydraulic Oil Filter..... H-5526 Hydraulic Oil Filter..... HC-5504 Oil Filter Full Flow..... C-5516		594H <i>(PIPE LAYERS)</i> S/N: 96V1-UP Air Filter Secondary..... A-5529 Air Filter Primary..... A-5521 Air Filter Set..... A-5521-S Air Filter Secondary..... A-5556 Air Filter Set..... A-5555-S Air Filter Primary..... A-5555 Fuel Filter Secondary..... FC-5507 Hydraulic Oil Filter..... H-5503 Oil Filter Full Flow..... O-5505 Oil Filter Full Flow..... C-5516		613C SERIES II <i>(SCRAPERS)</i> CAT 3116T (S/N: 93X2780-UP) Air Filter Secondary..... A-5559 Air Filter Primary..... A-5558 Air Filter Set..... A-5544-S Air Filter Primary..... A-5543 Fuel Filter Secondary..... FC-55151 Fuel Filter Secondary..... FC-5515 Fuel Filter..... FC-5516 Oil Filter Full Flow..... C-5510	
587R <i>(PIPE LAYERS)</i> CAT S/N: BXL1-UP Air Filter Set..... A-5555-S Air Filter Primary..... A-5555 Air Filter Secondary..... A-5556 Fuel Filter..... FC-5509 Hydraulic Oil Filter..... H-5526 Hydraulic Oil Filter..... H-55280 Hydraulic Oil Filter..... HC-5504 Oil Filter Full Flow..... C-5516		611 <i>(SCRAPERS)</i> CAT 3306 (S/N: 6S21-UP) Air Filter Primary..... A-5558 Air Filter Secondary..... A-5559 Fuel Filter..... F-5505 Fuel Filter Secondary..... FC-5507 Hydraulic Oil Filter..... H-5504 Hydraulic Oil Filter..... H-5509 Hydraulic Oil Filter..... H-55270 Oil Filter Full Flow..... C-5510		613 <i>(SCRAPERS)</i> S/N: 71M1-1377 Air Filter Set..... A-5522-S Air Filter Secondary..... A-5510 Air Filter Primary..... A-5509 Air Filter Set..... A-5549M-S Air Filter Secondary..... A-5550 Air Filter Primary..... A-5549 Air Filter Primary..... A-5549M Fuel Filter Secondary..... FC-5507 Fuel Filter..... FC-5503 Hydraulic Oil Filter..... H-5504 Hydraulic Oil Filter..... H-5503 Oil Filter Full Flow..... C-5504	
589 <i>(PIPE LAYERS)</i> CAT 3408 TA (S/N: 9BA1-UP) Air Filter Set..... A-5521-S Air Filter Primary..... A-5521		611 <i>(SCRAPERS)</i> CAT 3306 (S/N: 7WZ1-UP) Air Filter Secondary..... A-5559 Air Filter Primary..... A-5558 Fuel Filter Secondary..... FC-5507 Fuel Filter..... F-5505 Hydraulic Oil Filter..... H-55270 Hydraulic Oil Filter..... H-5509 Hydraulic Oil Filter..... H-5504 Oil Filter Full Flow..... C-5510		613 <i>(SCRAPERS)</i> S/N: 71M1378-UP Air Filter Primary..... A-5549M Air Filter Primary..... A-5549 Air Filter Secondary..... A-5550 Air Filter Set..... A-5549M-S Air Filter Primary..... A-5509	
589 <i>(PIPE LAYERS)</i> S/N: 31Z1-UP Air Filter Set..... A-5521-S Air Filter Primary..... A-5521 Air Filter Secondary..... A-5552 Air Filter Secondary..... A-5560 Air Filter Primary..... A-5561 Air Filter Set..... A-5562-S Fuel Filter..... F-5505 Hydraulic Oil Filter..... H-55270 Hydraulic Oil Filter..... H-5504 Hydraulic Oil Filter..... H-5509 Oil Filter Full Flow..... C-5516		613C <i>(SCRAPERS)</i> CAT 3208 (S/N: 92X1-UP) Air Filter Set..... A-5544-S Air Filter Primary..... A-5543 Fuel Filter..... F-5505 Fuel Filter Secondary..... FC-5507 Hydraulic Oil Filter..... H-5504 Hydraulic Oil Filter..... H-5503 Oil Filter Full Flow..... C-5519		613 <i>(SCRAPERS)</i> S/N: 71M1378-UP Air Filter Primary..... A-5549M Air Filter Primary..... A-5549 Air Filter Secondary..... A-5550 Air Filter Set..... A-5549M-S Air Filter Primary..... A-5509	
591 <i>(PIPE LAYERS)</i> Fuel Filter..... FC-5519 Hydraulic Oil Filter..... H-5504 Oil Filter Full Flow..... C-5516					
594 <i>(PIPE LAYERS)</i> S/N: 62H1-UP					

MODEL/APPLICATION	SAKURA NO	MODEL/APPLICATION	SAKURA NO	MODEL/APPLICATION	SAKURA NO
CATERPILLAR		CATERPILLAR		CATERPILLAR	
613 (SCRAPERS) S/N: 71M1378-UP		615 (SCRAPERS) S/N: 4621453-UP		Air Filter Primary.....	A-5543
Air Filter Secondary.....	A-5510	Air Filter Set.....	A-5544-S	Air Filter Set.....	A-5544-S
Air Filter Set.....	A-5522-S	Air Filter Primary.....	A-5543	Air Filter Primary.....	A-5558
Fuel Filter Secondary.....	FC-5507	Hydraulic Oil Filter.....	H-55270	Hydraulic Oil Filter.....	H-5509
Hydraulic Oil Filter.....	H-5504			Hydraulic Oil Filter.....	H-55270
Hydraulic Oil Filter.....	H-5503				
Oil Filter Full Flow.....	C-5504				
		615 (SCRAPERS) S/N: 4621-UP		619C (SCRAPERS) S/N: 61F1-UP	
613 (SCRAPERS) S/N: 72M1-4267		Air Filter Secondary.....	A-5559	Air Filter Secondary.....	A-5510
Air Filter Set.....	A-5549M-S	Air Filter Primary.....	A-5558	Air Filter Set.....	A-5522-S
Air Filter Secondary.....	A-5550	Hydraulic Oil Filter.....	H-5504	Air Filter Primary.....	A-5509
Air Filter Primary.....	A-5549	Oil Filter Full Flow.....	C-5510	Air Filter Set.....	A-5549M-S
Air Filter Primary.....	A-5549M			Air Filter Secondary.....	A-5550
		615 (SCRAPERS) S/N: 4721-UP		Air Filter Primary.....	A-5549
		Fuel Filter.....	F-5505	Air Filter Primary.....	A-5549M
613B (SCRAPERS)				Fuel Filter.....	F-5501
Hydraulic Oil Filter.....	H-55320	615C (SCRAPERS) CAT 3306 (S/N: 2XG1-UP)		Hydraulic Oil Filter.....	H-5503
		Air Filter Primary.....	A-5543	Oil Filter Full Flow.....	O-5503
613B (SCRAPERS) S/N: 38W1-UP		Air Filter Set.....	A-5544-S		
Air Filter Primary.....	A-5509	Fuel Filter.....	F-5505	619C (SCRAPERS) S/N: 62F1-UP	
Air Filter Set.....	A-5522-S	Fuel Filter Secondary.....	FC-5507	Air Filter Primary.....	A-5549M
Air Filter Secondary.....	A-5510	Hydraulic Oil Filter.....	H-5509	Air Filter Primary.....	A-5549
Air Filter Primary.....	A-5549M	Hydraulic Oil Filter.....	H-5504	Air Filter Secondary.....	A-5550
Air Filter Primary.....	A-5549	Oil Filter Full Flow.....	C-5510	Air Filter Set.....	A-5549M-S
Air Filter Secondary.....	A-5550			Air Filter Primary.....	A-5509
Air Filter Set.....	A-5549M-S	615C (SCRAPERS) CAT 3306 (S/N: 5TF1-UP)		Air Filter Set.....	A-5522-S
Fuel Filter Secondary.....	FC-5507	Air Filter Set.....	A-5544-S	Air Filter Secondary.....	A-5510
Hydraulic Oil Filter.....	H-5503	Air Filter Primary.....	A-5543	Fuel Filter.....	F-5501
Hydraulic Oil Filter.....	H-5504	Fuel Filter Secondary.....	FC-5507	Hydraulic Oil Filter.....	H-5503
Oil Filter Full Flow.....	C-5519	Fuel Filter.....	F-5505	Oil Filter Full Flow.....	O-5503
		Hydraulic Oil Filter.....	H-5504		
613C II US (SCRAPERS) CAT 3116 (S/N: 8LJ1-UP)		Hydraulic Oil Filter.....	H-5509	621 (SCRAPERS) S/N: 23H1-UP	
Air Filter Secondary.....	A-5520	Oil Filter Full Flow.....	C-5510	Air Filter Secondary.....	A-5520
Air Filter Primary.....	A-5558			Air Filter Primary.....	A-5543
Air Filter Set.....	A-5544-S	615C (SCRAPERS) CAT 3306T (S/N: 5TF1-UP)		Air Filter Primary.....	A-5558
Air Filter Primary.....	A-5543	Air Filter Primary.....	A-5543	Air Filter Set.....	A-5544-S
Air Filter Secondary.....	A-5559	Air Filter Secondary.....	A-5559	Air Filter Secondary.....	A-5559
Fuel Filter Secondary.....	FC-5507	Air Filter Set.....	A-5544-S	Fuel Filter.....	F-5501
Hydraulic Oil Filter.....	H-5504	Air Filter Primary.....	A-5558	Hydraulic Oil Filter.....	H-5503
Hydraulic Oil Filter.....	H-5503	Fuel Filter Secondary.....	FC-5507	Hydraulic Oil Filter.....	H-5504
		Hydraulic Oil Filter.....	H-5509	Oil Filter Full Flow.....	O-5502
613C II US (SCRAPERS) CAT 3116 (S/N: 93X2780-UP)		Hydraulic Oil Filter.....	H-5504		
Air Filter Secondary.....	A-5559	Oil Filter Full Flow.....	C-5510	621G (SCRAPERS) CAT 3406E	
Air Filter Primary.....	A-5543			Fuel Filter.....	FC-5509
Air Filter Set.....	A-5544-S	615C II (SCRAPERS) CAT (S/N: 6NC1-UP)			
Air Filter Primary.....	A-5558	Fuel Filter Secondary.....	FC-5507	621G (SCRAPERS) CAT C9	
Air Filter Secondary.....	A-5559	Fuel Filter.....	FC-5509	Fuel Filter Secondary.....	FC-5507
Fuel Filter Secondary.....	FC-5507	Oil Filter Full Flow.....	C-5522		
Hydraulic Oil Filter.....	H-5503	Oil Filter Full Flow.....	C-5516	621G (SCRAPERS) S/N: CEN1-UP	
Hydraulic Oil Filter.....	H-5504			Air Filter Set.....	A-5562-S
		615C II (SCRAPERS) CAT S/N: 08Z469300-UP		Air Filter Primary.....	A-5561
613G (SCRAPERS) S/N: DBE1-UP		Fuel Filter Secondary.....	FC-5507	Air Filter Secondary.....	A-5560
Cabin Air Filter.....	CA-55160			Cabin Air Filter.....	CA-55060
		615C II (SCRAPERS) CAT S/N: 10Z46580-UP		Fuel Filter.....	FC-5509
615 (SCRAPERS) S/N: 4621-1452		Fuel Filter Secondary.....	FC-5507	Hydraulic Oil Filter.....	HC-5506
Air Filter Primary.....	A-5543			Hydraulic Oil Filter.....	HC-5503
Air Filter Set.....	A-5544-S	615C II (SCRAPERS) S/N: 9XG1-UP		Hydraulic Oil Filter.....	HC-5512
Hydraulic Oil Filter.....	H-55270	Air Filter Secondary.....	A-5559	Hydraulic Oil Filter.....	H-5509
				Hydraulic Oil Filter.....	HC-55300

MODEL/APPLICATION	SAKURA NO	MODEL/APPLICATION	SAKURA NO	MODEL/APPLICATION	SAKURA NO
CATERPILLAR		CATERPILLAR		CATERPILLAR	
621G (SCRAPERS) S/N: DBB1-UP		621B (SCRAPERS) S/N: 73V1-UP		Fuel Filter Secondary.....	FC-5507
Air Filter Secondary.....	A-5560	Fuel Filter Secondary.....	FC-5507	Hydraulic Oil Filter.....	H-5504
Air Filter Primary.....	A-5561			Oil Filter Full Flow.....	C-5516
Air Filter Set.....	A-5562-S	621B (SCRAPERS) S/N: 7KC1-UP		621 E (SCRAPERS) S/N: 6BB1-UP	
Cabin Air Filter.....	CA-55060	Fuel Filter.....	FC-5509	Air Filter Primary.....	A-5535
Hydraulic Oil Filter.....	HC-55300	Fuel Filter.....	F-5505	Air Filter Primary.....	A-5501
Hydraulic Oil Filter.....	H-5509	Hydraulic Oil Filter.....	H-5504	Air Filter Set.....	A-5573-S
Hydraulic Oil Filter.....	HC-5512	Hydraulic Oil Filter.....	H-5509	Air Filter Secondary.....	A-5534
Hydraulic Oil Filter.....	HC-5503	Hydraulic Oil Filter.....	H-55270	Air Filter Secondary.....	A-5502
Hydraulic Oil Filter.....	HC-5506	Oil Filter Full Flow.....	C-5516	Fuel Filter.....	FC-5519
621G (SCRAPERS) w/3406E Eng.		621B (SCRAPERS) S/N: 8HC1-UP		Fuel Filter.....	FC-5509
Hydraulic Oil Filter.....	H-55320	Fuel Filter.....	F-5505	Hydraulic Oil Filter.....	H-5504
621B (SCRAPERS)		Fuel Filter.....	FC-5509	Hydraulic Oil Filter.....	H-5509
Hydraulic Oil Filter.....	H-55320	Hydraulic Oil Filter.....	H-55270	Oil Filter Full Flow.....	C-5516
621B (SCRAPERS) S/N: 2DB1-UP		Hydraulic Oil Filter.....	H-5509	621 E (SCRAPERS) w/3406 Eng.	
Fuel Filter.....	F-5505	Hydraulic Oil Filter.....	H-5504	Air Filter Primary.....	A-5535M
Fuel Filter.....	FC-5509	Oil Filter Full Flow.....	C-5516	Air Filter Set.....	A-5573M-S
Hydraulic Oil Filter.....	H-55270	621B (SCRAPERS) S/N: 9AC1-UP		Hydraulic Oil Filter.....	H-55320
Hydraulic Oil Filter.....	H-5509	Fuel Filter.....	FC-5509	621F (SCRAPERS) S/N: 4SK1-UP	
Hydraulic Oil Filter.....	H-5504	Fuel Filter.....	F-5505	Hydraulic Oil Filter.....	H-5504
Oil Filter Full Flow.....	C-5516	Hydraulic Oil Filter.....	H-5504	Oil Filter Full Flow.....	C-5516
621B (SCRAPERS) S/N: 2GB1-UP		Hydraulic Oil Filter.....	H-5509	621F (SCRAPERS) S/N: 5JK1-UP	
Fuel Filter Secondary.....	FC-5507	Hydraulic Oil Filter.....	H-55270	Air Filter Secondary.....	A-5502
621B (SCRAPERS) S/N: 31V1-UP		Oil Filter Full Flow.....	C-5516	621F (SCRAPERS) S/N: 8PL1-UP	
Fuel Filter Secondary.....	FC-5507	621 E (SCRAPERS) S/N: 2PD1011-UP		Air Filter Secondary.....	A-5502
621B (SCRAPERS) S/N: 35V1-UP		Air Filter Primary.....	A-5535	621F (SCRAPERS) S/N: 9NL1-UP	
Fuel Filter Secondary.....	FC-5507	Air Filter Secondary.....	A-5502	Air Filter Secondary.....	A-5502
621B (SCRAPERS) S/N: 36V1-UP		Air Filter Secondary.....	A-5534	621F (SCRAPERS) S/N: 3406, 3406C Eng.	
Fuel Filter Secondary.....	FC-5507	Air Filter.....	A-5547	Air Filter Primary.....	A-5535M
621B (SCRAPERS) S/N: 45P1-UP		Air Filter Set.....	A-5573-S	Air Filter Set.....	A-5573M-S
Air Filter Secondary.....	A-5534	Air Filter Primary.....	A-5501	Hydraulic Oil Filter.....	H-55320
Air Filter Primary.....	A-5501	621 E (SCRAPERS) S/N: 2PD1-UP		621F BZ (SCRAPERS) CAT 3406 (S/N: 8PL1-UP)	
Air Filter Secondary.....	A-5502	Fuel Filter Secondary.....	FC-5507	Air Filter Secondary.....	A-5534
Air Filter Primary.....	A-5535	Hydraulic Oil Filter.....	H-5504	Air Filter Primary.....	A-5535
Air Filter Set.....	A-5573-S	Oil Filter Full Flow.....	C-5516	Air Filter Set.....	A-5573-S
Fuel Filter.....	FC-5519	621 E (SCRAPERS) S/N: 2PD687-1010		Fuel Filter.....	FC-5509
Fuel Filter Secondary.....	FC-5507	Air Filter.....	A-5547	Hydraulic Oil Filter.....	H-5504
Hydraulic Oil Filter.....	H-5504	621 E (SCRAPERS) S/N: 6AB1-905		Hydraulic Oil Filter.....	H-5509
Hydraulic Oil Filter.....	H-5509	Air Filter Primary.....	A-5501	Oil Filter Full Flow.....	C-5516
Oil Filter Full Flow.....	C-5516	Air Filter.....	A-5547	621F BZ (SCRAPERS) CAT 3406 (S/N: 9NL1-UP)	
621B (SCRAPERS) S/N: 6XB1-UP		Air Filter Secondary.....	A-5502	Air Filter Set.....	A-5573-S
Fuel Filter.....	F-5505	Hydraulic Oil Filter.....	H-5509	Air Filter Primary.....	A-5535
Fuel Filter.....	FC-5509	621 E (SCRAPERS) S/N: 6AB1-UP		Air Filter Secondary.....	A-5534
Hydraulic Oil Filter.....	H-55270	Air Filter Secondary.....	A-5534	Fuel Filter.....	FC-5509
Hydraulic Oil Filter.....	H-5509	Air Filter Set.....	A-5573-S	Hydraulic Oil Filter.....	H-5509
Hydraulic Oil Filter.....	H-5504	Air Filter Primary.....	A-5535	Hydraulic Oil Filter.....	H-5504
Oil Filter Full Flow.....	C-5516	621 E (SCRAPERS) S/N: 6AB1-UP		Oil Filter Full Flow.....	C-5516
		Air Filter Secondary.....	A-5534		
		Air Filter Set.....	A-5573-S		
		Air Filter Primary.....	A-5535		

MODEL/APPLICATION	SAKURA NO	MODEL/APPLICATION	SAKURA NO	MODEL/APPLICATION	SAKURA NO
CATERPILLAR		CATERPILLAR		CATERPILLAR	
621F BZ (SCRAPERS) CAT 3406C (S/N: 8PL1-UP)		623G (SCRAPERS) CAT (S/N: BET1-UP)		Oil Filter Full Flow.....	C-5516
Air Filter Secondary.....	A-5534	Oil Filter Full Flow.....	C-5516	623E (SCRAPERS) S/N: 5SG1-477	
Air Filter Primary.....	A-5535	623G (SCRAPERS) CAT (S/N: LHX1-UP)		Air Filter Secondary.....	A-5502
Air Filter Set.....	A-5573-S	Fuel Filter.....	FC-5517	Hydraulic Oil Filter.....	H-5504
Fuel Filter.....	FC-5509	Hydraulic Oil Filter.....	H-55270	Oil Filter Full Flow.....	C-5516
Hydraulic Oil Filter.....	H-5504	623G (SCRAPERS) S/N: 6PY1-UP		623E (SCRAPERS) S/N: 6CB1-UP	
Hydraulic Oil Filter.....	H-5509	Hydraulic Oil Filter.....	H-55270	Air Filter Secondary.....	A-5502
Oil Filter Full Flow.....	C-5516	Hydraulic Oil Filter.....	H-5504	Air Filter Secondary.....	A-5534
621F BZ (SCRAPERS) CAT 3406C (S/N: 9NL1-UP)		623G (SCRAPERS) S/N: ARW1-UP		Air Filter Primary.....	A-5535
Air Filter Set.....	A-5573-S	Air Filter Secondary.....	A-5560	Air Filter Secondary.....	A-5534
Air Filter Primary.....	A-5535	Air Filter Primary.....	A-5561	Air Filter Secondary.....	A-5502
Air Filter Secondary.....	A-5534	Air Filter Set.....	A-5562-S	Air Filter Set.....	A-5573-S
Fuel Filter.....	FC-5509	Fuel Filter.....	FC-5509	Air Filter Primary.....	A-5501
Hydraulic Oil Filter.....	H-5509	Fuel/Water Separator Secondary..	SFC-5504-10B	Fuel Filter.....	FC-5509
Hydraulic Oil Filter.....	H-5504	Fuel/Water Separator Secondary...	SFC-5504-10	Fuel Filter.....	FC-5519
Oil Filter Full Flow.....	C-5516	Hydraulic Oil Filter.....	H-5509	Hydraulic Oil Filter.....	H-5509
621F US (SCRAPERS) CAT 3406 (S/N: 4SK1-UP)		Hydraulic Oil Filter.....	HC-55300	Hydraulic Oil Filter.....	H-5504
Air Filter Primary.....	A-5501	623G (SCRAPERS) S/N: CES1-UP		Oil Filter Full Flow.....	C-5516
Fuel Filter Secondary.....	A-5502	Air Filter Secondary.....	A-5560	623E (SCRAPERS) S/N: 6YF1-UP	
Air Filter Secondary.....	A-5501	Air Filter Set.....	A-5562-S	Air Filter Secondary.....	A-5502
Fuel Filter.....	FC-5509	Air Filter Primary.....	A-5561	Air Filter Secondary.....	A-5534
Hydraulic Oil Filter.....	H-5504	Cabin Air Filter.....	CA-55060	Air Filter Primary.....	A-5535
Hydraulic Oil Filter.....	H-5509	Fuel Filter.....	FC-5509	Air Filter Set.....	A-5573-S
Oil Filter Full Flow.....	C-5516	Hydraulic Oil Filter.....	H-5509	Fuel Filter.....	FC-5509
621F US (SCRAPERS) CAT 3406C (S/N: 5JK1-UP)		Hydraulic Oil Filter.....	HC-55300	Hydraulic Oil Filter.....	H-5504
Air Filter Secondary.....	A-5502	623G (SCRAPERS) S/N: DBC1-UP		Oil Filter Full Flow.....	C-5516
Air Filter Primary.....	A-5501	Air Filter Secondary.....	A-5560	623E (SCRAPERS) w/3406, 3406C Engs.	
Fuel Filter.....	FC-5509	Air Filter Primary.....	A-5561	Air Filter Set.....	A-5573M-S
Hydraulic Oil Filter.....	H-5504	Air Filter Set.....	A-5562-S	Air Filter Primary.....	A-5535M
Hydraulic Oil Filter.....	H-5509	Cabin Air Filter.....	CA-55060	Hydraulic Oil Filter.....	H-55320
Oil Filter Full Flow.....	C-5516	Hydraulic Oil Filter.....	HC-55300	623F (SCRAPERS) w/3406, 3406C Engs.	
621F US (SCRAPERS) CAT 3406C (S/N: 5JK1-UP)		Hydraulic Oil Filter.....	H-5509	Air Filter Primary.....	A-5535M
Air Filter Primary.....	A-5501	623G (SCRAPERS) w/3406E Eng.		Air Filter Set.....	A-5573M-S
Air Filter Secondary.....	A-5502	Hydraulic Oil Filter.....	H-55320	Hydraulic Oil Filter.....	H-55320
Fuel Filter.....	FC-5509	623B (SCRAPERS)		623 (SCRAPERS) S/N: 52U1-UP	
Hydraulic Oil Filter.....	H-5504	Air Filter Set.....	A-44150-S	Air Filter Secondary.....	A-5520
Hydraulic Oil Filter.....	H-5509	Air Filter Primary.....	A-44150	Air Filter Set.....	A-5544-S
Oil Filter Full Flow.....	C-5516	Hydraulic Oil Filter.....	H-55320	Air Filter Primary.....	A-5558
621S (SCRAPERS) S/N: 1TE1-UP		623B (SCRAPERS) S/N: 46P1-UP		Air Filter Primary.....	A-5543
Hydraulic Oil Filter.....	H-5504	Air Filter Primary.....	A-5501	Air Filter Secondary.....	A-5559
Hydraulic Oil Filter.....	H-55270	Air Filter Secondary.....	A-5502	Fuel Filter.....	F-5501
621S (SCRAPERS) w/3306 Eng.		Air Filter Secondary.....	A-5534	Hydraulic Oil Filter.....	H-5509
Hydraulic Oil Filter.....	H-55320	Air Filter Primary.....	A-5535	Hydraulic Oil Filter.....	H-5504
		Air Filter Set.....	A-5573-S	Oil Filter Full Flow.....	O-5502
		Fuel Filter.....	FC-5519	624F (LOADERS) S/N: 4YN-UP	
		Fuel Filter.....	FC-5509		
		Hydraulic Oil Filter.....	H-5509		
		Hydraulic Oil Filter.....	H-5504		

MODEL/APPLICATION	SAKURA NO	MODEL/APPLICATION	SAKURA NO	MODEL/APPLICATION	SAKURA NO
CATERPILLAR		CATERPILLAR		CATERPILLAR	
624F (LOADERS) S/N: 4YN-UP		Cabin Air Filter.....	CA-55060	Air Filter Primary.....	A-5543
Air Filter Secondary.....	A-5567	Hydraulic Oil Filter.....	HC-5503	627F (SCRAPERS) S/N: 3GB900-UP	
Air Filter Primary.....	A-5566	Hydraulic Oil Filter.....	H-5509	Hydraulic Oil Filter.....	H-55270
Air Filter Set.....	A-5568-S	Hydraulic Oil Filter.....	HC-5506	627F (SCRAPERS) S/N: 3JB500-UP	
Fuel Filter.....	F-5505	Hydraulic Oil Filter.....	HC-5512	Hydraulic Oil Filter.....	H-55270
Fuel Filter.....	FC-5516	Hydraulic Oil Filter.....	HC-55300	627F (SCRAPERS) S/N: 4RY489-UP	
Fuel Filter Secondary.....	FC-55151	627G (SCRAPERS) S/N: DRX1-UP		Hydraulic Oil Filter.....	H-55270
Fuel Filter Secondary.....	FC-5515	Hydraulic Oil Filter.....	H-55270	627F (SCRAPERS) S/N: 4YK244-UP	
Hydraulic Oil Filter.....	H-5506	627G (SCRAPERS) S/N: M1R1-UP		Air Filter Secondary.....	A-5560
Hydraulic Oil Filter.....	HC-5504	Hydraulic Oil Filter.....	H-55270	Air Filter Primary.....	A-5561
Oil Filter Full Flow.....	C-5505	627G (SCRAPERS) w/3406E Eng.		Air Filter Set.....	A-5562-S
Oil Filter Full Flow.....	C-5510	Hydraulic Oil Filter.....	H-55320	627F (SCRAPERS) w/3406B Eng.	
624F (LOADERS) S/N: 5NN-UP		627G (SCRAPERS) w/C9 Eng.		Air Filter Primary.....	A-5535M
Air Filter Set.....	A-5568-S	Air Filter Primary.....	A-5535M	Air Filter Set.....	A-5573M-S
Air Filter Primary.....	A-5566	Air Filter Set.....	A-5573M-S	627F (SCRAPERS) CAT (S/N: 08Z72000-89611-UP)	
Air Filter Secondary.....	A-5567	Fuel Filter Secondary.....	FC-5507	Fuel Filter Secondary.....	FC-5507
Fuel Filter.....	F-5505	Oil Filter Full Flow.....	C-5510	Oil Filter Full Flow.....	C-5510
Fuel Filter Secondary.....	FC-5515	627F (SCRAPERS) CAT (S/N: 08Z89612-UP)		627B (SCRAPERS)	
Fuel Filter Secondary.....	FC-55151	Fuel Filter Secondary.....	FC-5507	Air Filter Primary.....	A-44150
Fuel Filter.....	FC-5516	Oil Filter Full Flow.....	C-5522	Air Filter Set.....	A-44150-S
Hydraulic Oil Filter.....	HC-5504	627F (SCRAPERS) CAT (S/N: 11N7400-UP)		627B (SCRAPERS) S/N: 37V1-UP	
Hydraulic Oil Filter.....	H-5506	Oil Filter Full Flow.....	C-5516	Air Filter Primary.....	A-5558
Oil Filter Full Flow.....	C-5510	627F (SCRAPERS) CAT (S/N: 41Z1-UP)		Air Filter Secondary.....	A-5559
Oil Filter Full Flow.....	C-5505	Fuel Filter.....	FC-5509	Fuel Filter Secondary.....	FC-5507
627G (SCRAPERS) CAT 3406E (S/N: AYK1-UP)		Fuel Filter.....	FC-5519	Hydraulic Oil Filter.....	H-5504
Air Filter Set.....	A-5562-S	627F (SCRAPERS) CAT (S/N: 6NC1-UP)		Oil Filter Full Flow.....	C-5510
Air Filter Primary.....	A-5561	Fuel Filter.....	FC-5509	627B (SCRAPERS) S/N: 38V1-UP	
Air Filter Secondary.....	A-5560	Fuel Filter Secondary.....	FC-5507	Air Filter Secondary.....	A-5559
Fuel Filter.....	F-5505	Oil Filter Full Flow.....	C-5516	Air Filter Primary.....	A-5558
Fuel Filter Secondary.....	FC-5507	Oil Filter Full Flow.....	C-5522	Fuel Filter Secondary.....	FC-5507
Hydraulic Oil Filter.....	HC-5512	627F (SCRAPERS) S/N: 1DL1-UP		Hydraulic Oil Filter.....	H-5504
Hydraulic Oil Filter.....	H-5504	Air Filter Secondary.....	A-5534	Oil Filter Full Flow.....	C-5510
Hydraulic Oil Filter.....	H-55270	Air Filter Primary.....	A-5535	627B (SCRAPERS) w/3306 Eng.	
Oil Filter Full Flow.....	C-5510	Air Filter Set.....	A-5573-S	Hydraulic Oil Filter.....	H-55320
627G (SCRAPERS) S/N: 3GB1-UP		Hydraulic Oil Filter.....	H-5509	627E (SCRAPERS) CAT 3406 (S/N: 6EBI-UP)	
Hydraulic Oil Filter.....	H-55270	Hydraulic Oil Filter.....	HC-5512	Air Filter Primary.....	A-5501
627G (SCRAPERS) S/N: 3JB1-UP		Hydraulic Oil Filter.....	HC-5512	Air Filter Set.....	A-5544-S
Hydraulic Oil Filter.....	H-55270	Hydraulic Oil Filter.....	HC-5506	Air Filter Primary.....	A-5543
627G (SCRAPERS) S/N: CEX1-UP		Hydraulic Oil Filter.....	HC-5506	Air Filter.....	A-5547
Cabin Air Filter.....	CA-55060	Hydraulic Oil Filter.....	H-5509	Fuel Filter.....	F-5505
Fuel Filter.....	FC-5509	627F (SCRAPERS) S/N: 1WE2000-UP		Fuel Filter Secondary.....	FC-5507
Hydraulic Oil Filter.....	HC-55300	Hydraulic Oil Filter.....	H-55270	Hydraulic Oil Filter.....	H-5509
Hydraulic Oil Filter.....	HC-5512	Hydraulic Oil Filter.....	H-5504	Hydraulic Oil Filter.....	H-5504
Hydraulic Oil Filter.....	HC-5512	627F (SCRAPERS) S/N: 2YK1-243-UP		Oil Filter Full Flow.....	C-5516
Hydraulic Oil Filter.....	HC-5506	Air Filter Set.....	A-5544-S	627E (SCRAPERS) CAT 3406 (S/N: 6FB1-UP)	
Hydraulic Oil Filter.....	H-5509	627G (SCRAPERS) S/N: DBD1-UP		Air Filter.....	A-5547
Hydraulic Oil Filter.....	HC-5503	Hydraulic Oil Filter.....	H-55270	Air Filter Primary.....	A-5543
627G (SCRAPERS) S/N: CWK1-UP		627F (SCRAPERS) S/N: 2YK1-243-UP			
Hydraulic Oil Filter.....	H-55270	Air Filter Set.....	A-5544-S		

MODEL/APPLICATION	SAKURA NO
CATERPILLAR	
627E (SCRAPERS) CAT 3406 (S/N: 6FB1-UP)	
Air Filter Set.....	A-5544-S
Air Filter Primary.....	A-5501
Fuel Filter Secondary.....	FC-5507
Fuel Filter.....	F-5505
Hydraulic Oil Filter.....	H-5504
Hydraulic Oil Filter.....	H-5509
Oil Filter Full Flow.....	C-5516
627E (SCRAPERS) CAT 3406 (S/N: 6GB1-UP)	
Air Filter Primary.....	A-5501
Air Filter Set.....	A-5544-S
Air Filter Primary.....	A-5543
Air Filter.....	A-5547
Fuel Filter.....	F-5505
Fuel Filter Secondary.....	FC-5507
Hydraulic Oil Filter.....	H-5509
Hydraulic Oil Filter.....	H-5504
Oil Filter Full Flow.....	C-5516
627E (SCRAPERS) w/3306 Eng.	
Hydraulic Oil Filter.....	H-55320
627E (SCRAPERS) w/3406 Eng.	
Air Filter Primary.....	A-5535M
Air Filter Set.....	A-5573M-S
Hydraulic Oil Filter.....	H-55320
627 (SCRAPERS) S/N: 54K1-UP	
Fuel Filter.....	F-5503
627 (SCRAPERS) S/N: 14S1-UP	
Air Filter Primary.....	A-5501
Air Filter Secondary.....	A-5502
Hydraulic Oil Filter.....	H-5504
Hydraulic Oil Filter.....	H-5509
Oil Filter Full Flow.....	C-5510
627 (SCRAPERS) S/N: 15S1-UP	
Air Filter Secondary.....	A-5502
Air Filter Primary.....	A-5501
Hydraulic Oil Filter.....	H-5509
Hydraulic Oil Filter.....	H-5504
Oil Filter Full Flow.....	C-5510
627 (SCRAPERS) S/N: 50K1-UP	
Fuel Filter Secondary.....	FC-5507
Oil Filter Full Flow.....	C-5510
627 (SCRAPERS) S/N: 54K1451-UP	
Air Filter Primary.....	A-5509
Air Filter Secondary.....	A-5510
Air Filter Set.....	A-5522-S
Air Filter Primary.....	A-5549M
Air Filter Primary.....	A-5549
Air Filter Secondary.....	A-5550

MODEL/APPLICATION	SAKURA NO
CATERPILLAR	
Air Filter Set.....	A-5549M-S
Fuel Filter Secondary.....	FC-5507
Hydraulic Oil Filter.....	H-5504
Hydraulic Oil Filter.....	H-5503
Oil Filter Full Flow.....	C-5510
627 (SCRAPERS) S/N: 54K1-736	
Air Filter Set.....	A-5522-S
Air Filter Secondary.....	A-5510
Air Filter Primary.....	A-5509
Air Filter Set.....	A-5549M-S
Air Filter Secondary.....	A-5550
Air Filter Primary.....	A-5549
Air Filter Primary.....	A-5549M
Fuel Filter Secondary.....	FC-5507
Hydraulic Oil Filter.....	H-5503
Hydraulic Oil Filter.....	H-5504
Oil Filter Full Flow.....	O-5502
627 (SCRAPERS) S/N: 54K737-888	
Air Filter Primary.....	A-5549M
Air Filter Primary.....	A-5549
Air Filter Secondary.....	A-5550
Air Filter Set.....	A-5549M-S
Air Filter Primary.....	A-5509
Air Filter Secondary.....	A-5510
Air Filter Set.....	A-5522-S
Fuel Filter Secondary.....	FC-5507
Hydraulic Oil Filter.....	H-5504
Hydraulic Oil Filter.....	H-5503
Oil Filter Full Flow.....	C-5510
627 (SCRAPERS) S/N: 54K889-1450	
Air Filter Set.....	A-5522-S
Air Filter Secondary.....	A-5510
Air Filter Primary.....	A-5509
Air Filter Set.....	A-5549M-S
Air Filter Secondary.....	A-5550
Air Filter Primary.....	A-5549
Air Filter Primary.....	A-5549M
Fuel Filter Secondary.....	FC-5507
Hydraulic Oil Filter.....	H-5503
Oil Filter Full Flow.....	C-5510
627 (SCRAPERS) S/N: 68M1551-UP	
Air Filter Primary.....	A-5535
Air Filter Set.....	A-5573-S
Air Filter Secondary.....	A-5534
Air Filter Primary.....	A-5501
Air Filter Secondary.....	A-5502
Fuel Filter Secondary.....	FC-5507
Hydraulic Oil Filter.....	H-5504
Oil Filter Full Flow.....	C-5510
627 (SCRAPERS) S/N: 68M1-650	
Air Filter Primary.....	A-5509
Air Filter Secondary.....	A-5510
Air Filter Set.....	A-5522-S
Air Filter Primary.....	A-5549M

MODEL/APPLICATION	SAKURA NO
CATERPILLAR	
Air Filter Primary.....	A-5549
Air Filter Secondary.....	A-5550
Air Filter Set.....	A-5549M-S
Fuel Filter Secondary.....	FC-5507
Hydraulic Oil Filter.....	H-5504
Hydraulic Oil Filter.....	H-5503
Oil Filter Full Flow.....	O-5502
627 (SCRAPERS) S/N: 68M651-878	
Air Filter Set.....	A-5549M-S
Air Filter Secondary.....	A-5550
Air Filter Primary.....	A-5549
Air Filter Primary.....	A-5549M
Air Filter Set.....	A-5522-S
Air Filter Secondary.....	A-5510
Air Filter Primary.....	A-5509
Fuel Filter Secondary.....	FC-5507
Hydraulic Oil Filter.....	H-5503
Hydraulic Oil Filter.....	H-5504
Oil Filter Full Flow.....	C-5510
627 (SCRAPERS) S/N: 68M879-1550	
Air Filter Secondary.....	A-5534
Air Filter Secondary.....	A-5502
Air Filter Primary.....	A-5501
Air Filter Set.....	A-5573-S
Air Filter Primary.....	A-5535
Fuel Filter Secondary.....	FC-5507
Oil Filter Full Flow.....	C-5510
627 (SCRAPERS) S/N: 69M1-UP	
Fuel Filter Secondary.....	FC-5507
Oil Filter Full Flow.....	C-5510
627B TR (SCRAPERS) S/N: 15S1-UP	
Air Filter Primary.....	A-5535
Air Filter Secondary.....	A-5534
Air Filter Secondary.....	A-5502
Air Filter Primary.....	A-5501
Air Filter Set.....	A-5573-S
Fuel Filter Secondary.....	FC-5507
Hydraulic Oil Filter.....	H-5504
Oil Filter Full Flow.....	C-5510
627E PS (SCRAPERS) S/N: 6EB1-UP	
Air Filter Primary.....	A-5501
Fuel Filter.....	FC-5509
Fuel Filter.....	F-5505
Fuel Filter Secondary.....	FC-5507
Hydraulic Oil Filter.....	H-5509
Hydraulic Oil Filter.....	H-55270
Hydraulic Oil Filter.....	H-5504
Oil Filter Full Flow.....	C-5510
Oil Filter Full Flow.....	C-5516
627E PS (SCRAPERS) S/N: 6FB1-UP	
Air Filter Set.....	A-5544-S
Air Filter Primary.....	A-5543
Fuel Filter Secondary.....	FC-5507

MODEL/APPLICATION	SAKURA NO	MODEL/APPLICATION	SAKURA NO	MODEL/APPLICATION	SAKURA NO
CATERPILLAR		CATERPILLAR		CATERPILLAR	
627E PS (SCRAPERS) S/N: 6FB1-UP Fuel Filter..... F-5505 Hydraulic Oil Filter..... H-5504 Hydraulic Oil Filter..... H-55270 Oil Filter Full Flow..... C-5516 Oil Filter Full Flow..... C-5510		631D (SCRAPERS) S/N: 24W1-UP Air Filter Secondary..... A-5529 Air Filter Set..... A-5521-S Air Filter Primary..... A-5521 Air Filter Secondary..... A-5556 Air Filter Primary..... A-5555 Air Filter Set..... A-5555-S Fuel Filter..... FC-5509 Hydraulic Oil Filter..... H-5504 Oil Filter Full Flow..... C-5516		Hydraulic Oil Filter..... H-5509 Hydraulic Oil Filter..... HC-55310 Hydraulic Oil Filter..... HC-5512 Hydraulic Oil Filter..... HC-5506 Hydraulic Oil Filter..... HC-5503	
627E PS (SCRAPERS) S/N: 6GB1-UP Air Filter Primary..... A-5501 Fuel Filter..... FC-5509 Fuel Filter..... F-5505 Fuel Filter Secondary..... FC-5507 Hydraulic Oil Filter..... H-55270 Hydraulic Oil Filter..... H-5504 Hydraulic Oil Filter..... H-5509 Oil Filter Full Flow..... C-5510 Oil Filter Full Flow..... C-5516		631D (SCRAPERS) S/N: 28W1-UP Air Filter Secondary..... A-5529		631E II (SCRAPERS) S/N: 1AB1576-1639-UP Air Filter Primary..... A-5561 Air Filter..... A-5547 Air Filter Secondary..... A-5560 Air Filter Set..... A-5562-S Hydraulic Oil Filter..... HC-5503 Hydraulic Oil Filter..... HC-5506 Hydraulic Oil Filter..... HC-5512 Hydraulic Oil Filter..... HC-55310 Hydraulic Oil Filter..... H-5509	
627E PS (SCRAPERS) S/N: 6HB1-UP Air Filter Primary..... A-5543 Air Filter Set..... A-5544-S Fuel Filter Secondary..... FC-5507 Fuel Filter..... F-5505 Hydraulic Oil Filter..... H-5504 Hydraulic Oil Filter..... H-55270 Oil Filter Full Flow..... C-5516 Oil Filter Full Flow..... C-5510		631D (SCRAPERS) S/N: 29W1-UP Air Filter Secondary..... A-5529		631E II (SCRAPERS) S/N: 1AB1640-UP Air Filter Set..... A-5562-S Air Filter Secondary..... A-5560 Air Filter..... A-5547 Air Filter Primary..... A-5561 Hydraulic Oil Filter..... H-5509 Hydraulic Oil Filter..... HC-55310 Hydraulic Oil Filter..... HC-5512 Hydraulic Oil Filter..... HC-5506 Hydraulic Oil Filter..... HC-5503	
630 (SCRAPERS) S/N: 52F-52F Fuel Filter..... F-5501 Hydraulic Oil Filter..... H-5503 Oil Filter Full Flow..... O-5503		631D (SCRAPERS) S/N: 39W1-UP Air Filter Secondary..... A-5529		631E II (SCRAPERS) S/N: 1AB1-855-UP Air Filter..... A-5547 Air Filter Secondary..... A-5552 Air Filter Primary..... A-5521 Air Filter Set..... A-5521-S Hydraulic Oil Filter..... H-5509	
630B (SCRAPERS) S/N: 14G1-UP Air Filter Secondary..... A-5520 Air Filter Primary..... A-5543 Air Filter Set..... A-5544-S Air Filter Primary..... A-5558 Air Filter Secondary..... A-5559 Fuel Filter..... F-5501 Hydraulic Oil Filter..... H-5503 Oil Filter Full Flow..... O-5503		631D (SCRAPERS) S/N: 66W1-UP Air Filter Secondary..... A-5529 Hydraulic Oil Filter..... H-5504 Oil Filter Full Flow..... C-5516		631E II (SCRAPERS) S/N: 1AB856-1445-UP Air Filter Set..... A-5521-S Air Filter Primary..... A-5521 Air Filter Secondary..... A-5552 Air Filter..... A-5547 Hydraulic Oil Filter..... H-5509	
631 (SCRAPERS) S/N: 51F-UP Fuel Filter..... F-5501 Hydraulic Oil Filter..... H-5503 Oil Filter Full Flow..... O-5503		631D (SCRAPERS) S/N: 68W1-UP Air Filter Secondary..... A-5529		631E II (SCRAPERS) S/N: 1AB1446-1509-UP Air Filter..... A-5547 Air Filter Secondary..... A-5552 Air Filter Primary..... A-5521 Air Filter Set..... A-5521-S Hydraulic Oil Filter..... HC-5503 Hydraulic Oil Filter..... HC-5506 Hydraulic Oil Filter..... HC-5512 Hydraulic Oil Filter..... HC-55310 Hydraulic Oil Filter..... H-5509	
631 (SCRAPERS) S/N: 67M1-UP Air Filter Secondary..... A-5526 Air Filter Primary..... A-5557 Air Filter Set..... A-5557-S Hydraulic Oil Filter..... H-5504 Hydraulic Oil Filter..... H-5509 Oil Filter Full Flow..... O-5503		631D (SCRAPERS) S/N: 73W1-UP Air Filter Secondary..... A-5529 Hydraulic Oil Filter..... H-5504 Oil Filter Full Flow..... C-5516		631E II (SCRAPERS) S/N: 1AB1510-1575-UP Air Filter Secondary..... A-5552 Air Filter..... A-5547 Air Filter Set..... A-5521-S Air Filter Primary..... A-5521	

MODEL/APPLICATION	SAKURA NO	MODEL/APPLICATION	SAKURA NO	MODEL/APPLICATION	SAKURA NO
CATERPILLAR		CATERPILLAR		CATERPILLAR	
631E II (SCRAPERS) S/N: 1NB1390-UP Air Filter Primary.....	A-5561	Hydraulic Oil Filter.....	HC-5503	Fuel Filter.....	FC-5509
631E II (SCRAPERS) S/N: 3ND1-UP Air Filter Primary.....	A-5521	631G (SCRAPERS) S/N: DFA1-UP Air Filter Primary.....	A-5593	Hydraulic Oil Filter.....	H-5504
Air Filter Set.....	A-5521-S	Air Filter Set.....	A-5595-S	Oil Filter Full Flow.....	C-5516
Air Filter.....	A-5547	Air Filter Secondary.....	A-5594	631E (SCRAPERS) S/N: 1AB1510-1575 Air Filter.....	A-5547
Air Filter Secondary.....	A-5552	Cabin Air Filter.....	CA-55060	Air Filter Secondary.....	A-5552
631E II (SCRAPERS) S/N: 3TE1-UP Hydraulic Oil Filter.....	H-5504	Hydraulic Oil Filter.....	HC-5503	Air Filter Set.....	A-5521-S
Hydraulic Oil Filter.....	H-55270	Hydraulic Oil Filter.....	HC-5506	Air Filter Primary.....	A-5521
631E II (SCRAPERS) S/N: 8TA1-UP Hydraulic Oil Filter.....	H-55270	Hydraulic Oil Filter.....	HC-5512	Hydraulic Oil Filter.....	HC-5512
Hydraulic Oil Filter.....	H-5504	Hydraulic Oil Filter.....	HC-55300	Hydraulic Oil Filter.....	HC-55310
631E II (SCRAPERS) S/N: 9PE1-UP Hydraulic Oil Filter.....	H-5504	Hydraulic Oil Filter.....	H-5509	Hydraulic Oil Filter.....	H-5509
Hydraulic Oil Filter.....	H-55270	631G (SCRAPERS) w/3408E Eng. Hydraulic Oil Filter.....	H-55320	Hydraulic Oil Filter.....	HC-5503
631G (SCRAPERS) CAT S/N: 5XD1-UP , 2007-UP Air Filter Primary.....	A-5564	631B (SCRAPERS) S/N: 13G1-3686 Air Filter Secondary.....	A-5520	Hydraulic Oil Filter.....	HC-5506
Air Filter Set.....	A-5565-S	Air Filter Secondary.....	A-5559	Hydraulic Oil Filter.....	HC-5503
Air Filter Secondary.....	A-5563	Air Filter Primary.....	A-5558	Hydraulic Oil Filter.....	HC-5512
Fuel Filter.....	FC-5509	Air Filter Set.....	A-5544-S	Hydraulic Oil Filter.....	HC-5506
Fuel/Water Separator Secondary..	SFC-5504-10	Air Filter Primary.....	A-5543	Hydraulic Oil Filter.....	H-5509
Fuel/Water Separator Secondary..	SFC-5504-10B	Fuel Filter.....	F-5501	Hydraulic Oil Filter.....	HC-55310
Hydraulic Oil Filter.....	HC-5512	Hydraulic Oil Filter.....	H-5503	Hydraulic Oil Filter.....	HC-5512
Hydraulic Oil Filter.....	HC-5506	Oil Filter Full Flow.....	O-5503	631E (SCRAPERS) S/N: 1AB1576-1639 Air Filter Set.....	A-5562-S
Hydraulic Oil Filter.....	HC-5503	631B (SCRAPERS) S/N: 13G3687-UP Air Filter Primary.....	A-5543	Air Filter Primary.....	A-5561
631G (SCRAPERS) CAT S/N: AWK1-UP , 2007-UP Air Filter Secondary.....	A-5563	Air Filter Set.....	A-5544-S	Air Filter.....	A-5547
Air Filter Set.....	A-5565-S	Air Filter Primary.....	A-5558	Air Filter Primary.....	A-5561
Air Filter Primary.....	A-5564	Air Filter Secondary.....	A-5559	Air Filter Set.....	A-5562-S
Fuel Filter.....	FC-5509	Air Filter Secondary.....	A-5520	Hydraulic Oil Filter.....	HC-5512
Fuel/Water Separator Secondary..	SFC-5504-10B	Fuel Filter Secondary.....	FC-5507	Hydraulic Oil Filter.....	HC-55310
Fuel/Water Separator Secondary..	SFC-5504-10	Hydraulic Oil Filter.....	H-5503	Hydraulic Oil Filter.....	H-5509
Hydraulic Oil Filter.....	HC-5503	Hydraulic Oil Filter.....	H-5503	Hydraulic Oil Filter.....	HC-5503
Hydraulic Oil Filter.....	HC-5506	Oil Filter Full Flow.....	O-5503	Hydraulic Oil Filter.....	HC-5506
Hydraulic Oil Filter.....	HC-5512	631C (SCRAPERS) S/N: 13G3687-UP Hydraulic Oil Filter.....	H-55320	631E (SCRAPERS) S/N: 1AB1640-UP Air Filter Secondary.....	A-5560
631G (SCRAPERS) Fuel/Water Separator Primary....	SFC-5504-30B	631C (SCRAPERS) S/N: 67M1-4259 Hydraulic Oil Filter.....	H-5504	Air Filter.....	A-5547
Fuel/Water Separator Primary....	SFC-5504-30	Oil Filter Full Flow.....	O-5503	Air Filter Secondary.....	A-5552
631G (SCRAPERS) S/N: CLR1-UP Air Filter Secondary.....	A-5563	631C (SCRAPERS) S/N: 67M4260-UP Air Filter Secondary.....	A-5526	Air Filter Primary.....	A-5521
Air Filter Primary.....	A-5564	Air Filter Set.....	A-5557-S	Air Filter Set.....	A-5521-S
Air Filter Set.....	A-5565-S	Air Filter Primary.....	A-5557	Oil Filter Full Flow.....	C-5516
Cabin Air Filter.....	CA-55060	Fuel Filter Secondary.....	FC-5507	631E (SCRAPERS) S/N: 1BB1-1539 Air Filter Set.....	A-5521-S
Hydraulic Oil Filter.....	H-5509	Hydraulic Oil Filter.....	H-5504	Air Filter Primary.....	A-5521
Hydraulic Oil Filter.....	HC-55300	Oil Filter Full Flow.....	O-5503	Air Filter Secondary.....	A-5552
Hydraulic Oil Filter.....	HC-5512	631E (SCRAPERS) S/N: 1AB1-1639 Air Filter Secondary.....	A-5556	Air Filter Primary.....	A-5521
Hydraulic Oil Filter.....	HC-5506	Air Filter Set.....	A-5555-S	Air Filter Set.....	A-5521-S
		Air Filter Primary.....	A-5555	Air Filter Secondary.....	A-5560
		Air Filter Secondary.....	A-5560	Hydraulic Oil Filter.....	H-5504
		Air Filter Primary.....	A-5561	Oil Filter Full Flow.....	C-5516
		Air Filter Set.....	A-5562-S		

MODEL/APPLICATION	SAKURA NO	MODEL/APPLICATION	SAKURA NO	MODEL/APPLICATION	SAKURA NO
CATERPILLAR		CATERPILLAR		CATERPILLAR	
631E (SCRAPERS) S/N: 3ND1-UP Air Filter Secondary..... A-5560 Air Filter Secondary..... A-5552 Air Filter Set..... A-5521-S Air Filter Primary..... A-5521 Air Filter Primary..... A-5561 Air Filter Set..... A-5562-S Fuel Filter..... FC-5509 Hydraulic Oil Filter..... H-5504		Air Filter Set..... A-5544-S Air Filter Primary..... A-5543 Fuel Filter Secondary..... FC-5507 Hydraulic Oil Filter..... H-5503 Oil Filter Full Flow..... 0-5503 633 (SCRAPERS) S/N: 66M782-UP Air Filter Secondary..... A-5526 Air Filter Primary..... A-5557 Air Filter Set..... A-5557-S Hydraulic Oil Filter..... H-5504 Hydraulic Oil Filter..... H-5509 Oil Filter Full Flow..... 0-5503 633D (SCRAPERS) S/N: 19W1-UP Air Filter Secondary..... A-5529 633D (SCRAPERS) S/N: 25W1-UP Air Filter Secondary..... A-5529 Air Filter Primary..... A-5521 Air Filter Set..... A-5521-S Air Filter Primary..... A-5555 Air Filter Set..... A-5555-S Air Filter Secondary..... A-5556 Fuel Filter..... FC-5509 Hydraulic Oil Filter..... H-5504 Oil Filter Full Flow..... C-5516 633D (SCRAPERS) w/3408 Eng. Hydraulic Oil Filter..... H-55320 633E II (SCRAPERS) CAT S/N: 99C7560-UP Oil Filter Full Flow..... C-5516 633E II (SCRAPERS) S/N: 2P51-UP Air Filter..... A-5547 Air Filter Secondary..... A-5560 Air Filter Set..... A-5562-S Air Filter Primary..... A-5561 Fuel Filter..... FC-5509 Fuel/Water Separator Secondary... SFC-5504-10 Fuel/Water Separator Secondary.. SFC-5504-10B Hydraulic Oil Filter..... H-5509 Hydraulic Oil Filter..... HC-5503 Hydraulic Oil Filter..... HC-5512 Hydraulic Oil Filter..... HC-5506 633E II (SCRAPERS) S/N: 9PE1-UP Hydraulic Oil Filter..... H-5504 Hydraulic Oil Filter..... H-55270 633C (SCRAPERS) S/N: 66M1-UP Air Filter Secondary..... A-5526 Air Filter Set..... A-5557-S Air Filter Primary..... A-5557 Fuel Filter Secondary..... FC-5507 Hydraulic Oil Filter..... H-5504 Oil Filter Full Flow..... 0-5503		633E (SCRAPERS) Hydraulic Oil Filter..... H-55320 633E (SCRAPERS) S/N: 1EB1-309 Hydraulic Oil Filter..... HC-5503 637G (SCRAPERS) CAT 3408E (S/N: AWE1-UP) Air Filter Secondary..... A-5560 Air Filter Set..... A-5562-S Air Filter Primary..... A-5561 Fuel Filter..... F-5505 Fuel Filter Secondary..... FC-5507 Hydraulic Oil Filter..... H-5504 Hydraulic Oil Filter..... H-55270 Oil Filter Full Flow..... C-5510 637G (SCRAPERS) CAT 3408E (S/N: AYN1-UP) Air Filter Primary..... A-5561 Air Filter Set..... A-5562-S Air Filter Secondary..... A-5560 Fuel Filter Secondary..... FC-5507 Fuel Filter..... F-5505 Hydraulic Oil Filter..... H-55270 Hydraulic Oil Filter..... H-5504 Oil Filter Full Flow..... C-5510 637G (SCRAPERS) Fuel/Water Separator Primary.... SFC-5504-30 Fuel/Water Separator Primary.... SFC-5504-30B 637G (SCRAPERS) S/N: CEH1-UP Air Filter Secondary..... A-5563 Air Filter Primary..... A-5564 Air Filter Set..... A-5565-S Cabin Air Filter..... CA-55060 Hydraulic Oil Filter..... H-5509 Hydraulic Oil Filter..... HC-5512 Hydraulic Oil Filter..... HC-55300 Hydraulic Oil Filter..... HC-5503 Hydraulic Oil Filter..... HC-5506 637G (SCRAPERS) S/N: DF31-UP Air Filter Secondary..... A-5594 Air Filter Set..... A-5595-S Air Filter Primary..... A-5593 Cabin Air Filter..... CA-55060 Hydraulic Oil Filter..... HC-5506 Hydraulic Oil Filter..... HC-5503 Hydraulic Oil Filter..... HC-55300 Hydraulic Oil Filter..... HC-5512 Hydraulic Oil Filter..... H-5509 637G (SCRAPERS) w/3408E Eng. Hydraulic Oil Filter..... H-55320 637G (SCRAPERS) w/C18 Eng.	
631E (SCRAPERS) S/N: 4LD1-UP Air Filter Set..... A-5562-S Air Filter Primary..... A-5561 Air Filter Primary..... A-5521 Air Filter Set..... A-5521-S Air Filter Secondary..... A-5552 Air Filter Secondary..... A-5560 Fuel Filter..... FC-5509 Hydraulic Oil Filter..... H-5504		631E (SCRAPERS) w/3408, 3408C Engs. Hydraulic Oil Filter..... H-55320		632 (SCRAPERS) S/N: 14G-14G Air Filter Secondary..... A-5520 Air Filter Set..... A-5544-S Air Filter Primary..... A-5543 Fuel Filter..... F-5501 Hydraulic Oil Filter..... H-5503 Oil Filter Full Flow..... 0-5503	
632 (SCRAPERS) S/N: 14G1-UP Air Filter Primary..... A-5543 Air Filter Set..... A-5544-S Air Filter Primary..... A-5558 Air Filter Secondary..... A-5520 Air Filter Secondary..... A-5559 Fuel Filter..... F-5501 Hydraulic Oil Filter..... H-5503 Oil Filter Full Flow..... 0-5503		632 (SCRAPERS) S/N: 44J1-UP Air Filter Primary..... A-5543 Air Filter Set..... A-5544-S Air Filter Secondary..... A-5559 Air Filter Secondary..... A-5520 Air Filter Secondary..... A-5526 Air Filter Primary..... A-5558 Fuel Filter Secondary..... FC-5507 Hydraulic Oil Filter..... H-5503 Oil Filter Full Flow..... 0-5503		633 (SCRAPERS) S/N: 44J1-UP Air Filter Primary..... A-5543 Air Filter Set..... A-5544-S Air Filter Secondary..... A-5559 Air Filter Secondary..... A-5520 Air Filter Secondary..... A-5526 Air Filter Primary..... A-5558 Fuel Filter Secondary..... FC-5507 Hydraulic Oil Filter..... H-5503 Oil Filter Full Flow..... 0-5503	
633 (SCRAPERS) S/N: 66M1-781 Air Filter Primary..... A-5558 Air Filter Secondary..... A-5526 Air Filter Secondary..... A-5520 Air Filter Secondary..... A-5559					

MODEL/APPLICATION	SAKURA NO
CATERPILLAR	
637G (SCRAPERS) w/C18 Eng. Hydraulic Oil Filter.....	H-55320
637G (SCRAPERS) w/C9 Eng. Air Filter Set..... Air Filter Primary.....	A-5573M-S A-5535M
637D (SCRAPERS) CAT (S/N: 99C7615-UP) , 2011 Coolant Filter..... Coolant Filter..... Coolant Filter..... Fuel Filter..... Fuel/Water Separator..... Fuel/Water Separator..... Fuel/Water Separator Secondary.. Fuel/Water Separator Secondary.. Oil Filter By Pass..... Oil Filter Full Flow.....	WC-5705 WC-5707 WC-6901 FC-5509 SFC-5505 SF-5704 SFC-5504-10B SFC-5504-10 C-5718 C-5516
637D (SCRAPERS) CAT (S/N: THX10860-UP) , 2011 Coolant Filter..... Coolant Filter..... Coolant Filter..... Fuel Filter..... Fuel Filter..... Fuel/Water Separator..... Fuel/Water Separator..... Fuel/Water Separator Secondary.. Fuel/Water Separator Secondary.. Oil Filter Full Flow..... Oil Filter By Pass.....	WC-6901 WC-5707 WC-5705 FC-5509 FC-5517 SF-5704 SFC-5505 SFC-5504-10 SFC-5504-10B C-5516 C-5718
637D (SCRAPERS) CAT C10 (S/N: 2PN1-7341) , 2011 Coolant Filter..... Coolant Filter..... Coolant Filter..... Fuel Filter..... Fuel/Water Separator..... Fuel/Water Separator..... Fuel/Water Separator Secondary.. Fuel/Water Separator Secondary.. Oil Filter By Pass..... Oil Filter Full Flow.....	WC-5705 WC-5707 WC-6901 FC-5509 SFC-5505 SF-5704 SFC-5504-10B SFC-5504-10 C-5718 C-5516
637D (SCRAPERS) CAT C10 (S/N: 2PN7342-UP) , 2011 Coolant Filter..... Coolant Filter..... Coolant Filter..... Fuel Filter..... Fuel/Water Separator..... Fuel/Water Separator..... Fuel/Water Separator Secondary.. Fuel/Water Separator Secondary.. Oil Filter By Pass..... Oil Filter Full Flow.....	WC-6901 WC-5707 WC-5705 FC-5509 SF-5704 SFC-5505 SFC-5504-10 SFC-5504-10B C-5718 C-5516
637D (SCRAPERS) CAT C10 (S/N: 3CS1-UP) , 2011 Coolant Filter..... Coolant Filter..... Coolant Filter..... Fuel Filter..... Fuel/Water Separator..... Fuel/Water Separator..... Fuel/Water Separator Secondary.. Fuel/Water Separator Secondary.. Oil Filter Full Flow..... Oil Filter By Pass.....	WC-6901 WC-5707 WC-5705 FC-5509 SF-5704 SFC-5505 SFC-5504-10 SFC-5504-10B C-5516 C-5718

MODEL/APPLICATION	SAKURA NO
CATERPILLAR	
Coolant Filter..... Coolant Filter..... Coolant Filter..... Fuel Filter..... Fuel Filter..... Fuel/Water Separator..... Fuel/Water Separator..... Fuel/Water Separator Secondary.. Fuel/Water Separator Secondary.. Oil Filter By Pass..... Oil Filter Full Flow.....	WC-5705 WC-5707 WC-6901 FC-5517 FC-5509 SFC-5505 SF-5704 SFC-5504-10B SFC-5504-10 C-5718 C-5516
637D (SCRAPERS) CAT C10 (S/N: 8Y51-UP) , 2011 Coolant Filter..... Coolant Filter..... Coolant Filter..... Fuel Filter..... Fuel/Water Separator..... Fuel/Water Separator..... Fuel/Water Separator Secondary.. Fuel/Water Separator Secondary.. Oil Filter Full Flow..... Oil Filter By Pass.....	WC-6901 WC-5707 WC-5705 FC-5509 SF-5704 SFC-5505 SFC-5504-10 SFC-5504-10B C-5516 C-5718
637D (SCRAPERS) S/N: 20W1-UP Air Filter Secondary..... Air Filter Primary..... Hydraulic Oil Filter..... Oil Filter Full Flow.....	A-5559 A-5558 H-5504 C-5510
637D (SCRAPERS) S/N: 22W1-UP Air Filter Primary..... Air Filter Secondary..... Hydraulic Oil Filter..... Oil Filter Full Flow.....	A-5558 A-5559 H-5504 C-5510
637D (SCRAPERS) S/N: 26W1-UP Air Filter Set..... Air Filter Set..... Air Filter Primary..... Air Filter Primary..... Air Filter Secondary..... Air Filter Secondary..... Fuel Filter..... Hydraulic Oil Filter..... Oil Filter Full Flow.....	A-5555-S A-5521-S A-5521 A-5555 A-5556 A-5529 FC-5509 H-5504 C-5516
637D (SCRAPERS) S/N: 27W1-UP Air Filter Secondary..... Air Filter Secondary..... Air Filter Primary..... Air Filter Primary..... Air Filter Secondary..... Air Filter Secondary..... Fuel Filter..... Hydraulic Oil Filter..... Oil Filter Full Flow.....	A-5529 A-5556 A-5555 A-5521 A-5521-S A-5555-S FC-5509 H-5504 C-5516

MODEL/APPLICATION	SAKURA NO
CATERPILLAR	
637D (SCRAPERS) S/N: 4JB1-UP Air Filter Set..... Air Filter Set..... Air Filter Primary..... Air Filter Primary..... Fuel Filter..... Fuel Filter Secondary..... Hydraulic Oil Filter..... Hydraulic Oil Filter..... Oil Filter Full Flow.....	A-5544-S A-5521-S A-5521 A-5543 F-5505 FC-5507 H-5504 H-55270 C-5510
637E (SCRAPERS) 08Z63865-ON Oil Filter Full Flow.....	C-5506
637E (SCRAPERS) CAT 3306 (S/N: 1JB1-UP) Air Filter Primary..... Air Filter Set..... Air Filter Secondary..... Air Filter Secondary..... Fuel Filter..... Fuel Filter Secondary.....	A-5521 A-5521-S A-5552 A-5560 FC-5509 FC-5507
637E (SCRAPERS) CAT 3408 (S/N: 1JB1-UP) Air Filter Secondary..... Air Filter Secondary..... Air Filter Set..... Air Filter Primary..... Fuel Filter Secondary..... Fuel Filter.....	A-5560 A-5552 A-5521-S A-5521 FC-5507 FC-5509
637E (SCRAPERS) S/N: 1FB1-UP Air Filter Secondary..... Air Filter Primary..... Air Filter Set..... Air Filter Secondary..... Air Filter Set..... Air Filter Primary..... Fuel Filter..... Hydraulic Oil Filter..... Oil Filter Full Flow.....	A-5552 A-5521 A-5521-S A-5560 A-5562-S A-5561 FC-5509 H-5504 C-5516
637E (SCRAPERS) S/N: 1HB1-690 Air Filter Set..... Air Filter Primary..... Air Filter Secondary..... Air Filter Secondary..... Air Filter Set..... Air Filter Primary..... Air Filter Primary..... Fuel Filter Secondary..... Fuel Filter..... Hydraulic Oil Filter..... Hydraulic Oil Filter..... Oil Filter Full Flow.....	A-5562-S A-5558 A-5559 A-5560 A-5521-S A-5521 A-5544-S A-5543 A-5561 FC-5507 F-5505 H-55270 H-5504 C-5510

MODEL/APPLICATION	SAKURA NO	MODEL/APPLICATION	SAKURA NO	MODEL/APPLICATION	SAKURA NO
CATERPILLAR		CATERPILLAR		CATERPILLAR	
637E <i>(SCRAPERS)</i> S/N: 1HB1-809		Fuel Filter Secondary.....	FC-5507	Air Filter Set.....	A-5573-S
Air Filter Primary.....	A-5561	Oil Filter Full Flow.....	C-5516	Air Filter Set.....	A-5544-S
Air Filter Secondary.....	A-5560	Oil Filter Full Flow.....	C-5522	Air Filter Primary.....	A-5543
Air Filter Set.....	A-5562-S	637E II <i>(SCRAPERS)</i> CAT (S/N: 99C1-UP)		Air Filter Secondary.....	A-5534
Fuel Filter.....	FC-5509	Fuel Filter.....	FC-5509	Air Filter Primary.....	A-5535
Hydraulic Oil Filter.....	H-5504	Fuel/Water Separator Secondary..	SFC-5504-10		
Oil Filter Full Flow.....	C-5510	Fuel/Water Separator Secondary..	SFC-5504-10B	637E II <i>(SCRAPERS)</i> S/N: 1HB404-404-UP	
637E <i>(SCRAPERS)</i> S/N: 1HB810-UP		637E II <i>(SCRAPERS)</i> CAT S/N: 08Z33294-63864-UP		Air Filter Primary.....	A-5535
Air Filter Primary.....	A-5561	Fuel Filter Secondary.....	FC-5507	Air Filter Secondary.....	A-5534
Air Filter Set.....	A-5562-S	Oil Filter Full Flow.....	C-5510	Air Filter Secondary.....	A-5529
Air Filter Secondary.....	A-5560	637E II <i>(SCRAPERS)</i> CAT S/N: 08Z63866-UP		Air Filter Primary.....	A-5521
637E <i>(SCRAPERS)</i> S/N: 1LB1-UP		Fuel Filter Secondary.....	FC-5507	Air Filter Set.....	A-5521-S
Air Filter Secondary.....	A-5559	Oil Filter Full Flow.....	C-5510	Air Filter Set.....	A-5573-S
Air Filter Primary.....	A-5558	637E II <i>(SCRAPERS)</i> S/N: 1FB1-354-UP		Air Filter Set.....	A-5544-S
Hydraulic Oil Filter.....	H-5504	Air Filter.....	A-5547	Air Filter Primary.....	A-5543
Oil Filter Full Flow.....	C-5516	Hydraulic Oil Filter.....	H-5509	Air Filter Secondary.....	A-5534
637E <i>(SCRAPERS)</i> S/N: 7CB1-179		637E II <i>(SCRAPERS)</i> S/N: 1FB355-570-UP		Air Filter Primary.....	A-5535
Air Filter Primary.....	A-5543	Air Filter.....	A-5547	Air Filter Secondary.....	A-5534
Air Filter Set.....	A-5544-S	Hydraulic Oil Filter.....	H-5509	Air Filter Secondary.....	A-5529
Air Filter Primary.....	A-5521	637E II <i>(SCRAPERS)</i> S/N: 1FB571-633-UP		Air Filter Primary.....	A-5521
Air Filter Set.....	A-5521-S	Air Filter.....	A-5547	Air Filter Set.....	A-5521-S
Air Filter Primary.....	A-5558	Hydraulic Oil Filter.....	H-5509	Air Filter Set.....	A-5573-S
Air Filter Secondary.....	A-5559	637E II <i>(SCRAPERS)</i> S/N: 1FB634-659-UP		Air Filter Set.....	A-5573-S
Air Filter Set.....	A-5562-S	Air Filter.....	A-5547	Air Filter Set.....	A-5544-S
Air Filter Secondary.....	A-5560	Hydraulic Oil Filter.....	H-5509	Air Filter Primary.....	A-5543
Air Filter Primary.....	A-5561	637E II <i>(SCRAPERS)</i> S/N: 1FB660-UP		Air Filter Secondary.....	A-5534
Fuel Filter Secondary.....	FC-5507	Air Filter.....	A-5547	Air Filter Secondary.....	A-5529
Fuel Filter.....	F-5505	Hydraulic Oil Filter.....	H-5509	Air Filter Primary.....	A-5521
Hydraulic Oil Filter.....	H-5504	Hydraulic Oil Filter.....	HC-5503	Air Filter Set.....	A-5521-S
Hydraulic Oil Filter.....	H-55270	Hydraulic Oil Filter.....	HC-5512	Air Filter Set.....	A-5573-S
Oil Filter Full Flow.....	C-5510	Hydraulic Oil Filter.....	HC-5506	637E II <i>(SCRAPERS)</i> S/N: 1HB407-407-UP	
637E <i>(SCRAPERS)</i> w/3306 Eng.		637E II <i>(SCRAPERS)</i> S/N: 1FB811-400-UP		Air Filter Set.....	A-5573-S
Air Filter Set.....	A-5573M-S	Air Filter Set.....	A-5544-S	Air Filter Set.....	A-5544-S
Air Filter Primary.....	A-5535M	Air Filter Primary.....	A-5543	Air Filter Primary.....	A-5543
637E <i>(SCRAPERS)</i> w/3408, 3408E Engs.		Air Filter Secondary.....	A-5534	Air Filter Secondary.....	A-5534
Hydraulic Oil Filter.....	H-55320	Air Filter Primary.....	A-5535	Air Filter Secondary.....	A-5529
637E II <i>(SCRAPERS)</i> CAT (S/N: 08Z27183-33293-UP)		Air Filter Set.....	A-5573-S	Air Filter Primary.....	A-5521
Fuel Filter Secondary.....	FC-5507	637E II <i>(SCRAPERS)</i> S/N: 1HB401-401-UP		Air Filter Set.....	A-5521-S
Oil Filter Full Flow.....	C-5510	Air Filter Set.....	A-5521-S	Air Filter Set.....	A-5573-S
637E II <i>(SCRAPERS)</i> CAT (S/N: 08Z63865-63865-UP)		Air Filter Primary.....	A-5535	Air Filter Primary.....	A-5543
Fuel Filter Secondary.....	FC-5507	Air Filter Secondary.....	A-5534	Air Filter Secondary.....	A-5534
Oil Filter Full Flow.....	C-5510	Air Filter Secondary.....	A-5529	Air Filter Primary.....	A-5535
Oil Filter Full Flow.....	C-5522	Air Filter Primary.....	A-5521	637E II <i>(SCRAPERS)</i> S/N: 1HB410-410-UP	
637E II <i>(SCRAPERS)</i> CAT (S/N: 4ZF1-UP)		Air Filter Set.....	A-5573-S	Air Filter Set.....	A-5573-S
Fuel Filter.....	FC-5517	637E II <i>(SCRAPERS)</i> S/N: 1HB402-403-UP		Air Filter Set.....	A-5544-S
637E II <i>(SCRAPERS)</i> CAT (S/N: 6CN1-UP)		Air Filter Set.....	A-5521-S	Air Filter Primary.....	A-5543
Fuel Filter.....	FC-5509	637E II <i>(SCRAPERS)</i> S/N: 1HB402-403-UP		Air Filter Secondary.....	A-5534
		Air Filter Set.....	A-5573-S	Air Filter Secondary.....	A-5529
				Air Filter Primary.....	A-5521
				Air Filter Set.....	A-5521-S
				Air Filter Set.....	A-5573-S

Sakura Filter

ENGINE APPLICATION

MODEL/APPLICATION	SAKURA NO	MODEL/APPLICATION	SAKURA NO	MODEL/APPLICATION	SAKURA NO
CATERPILLAR		CATERPILLAR		CATERPILLAR	
637E II (SCRAPERS) S/N: 1HB567-682-UP Air Filter Set..... A-5573-S Air Filter Set..... A-5521-S Air Filter Primary..... A-5521 Air Filter Secondary..... A-5552 Air Filter Secondary..... A-5534 Air Filter Primary..... A-5535		Air Filter Secondary..... A-5534 Air Filter Primary..... A-5535 Air Filter Set..... A-5521-S Air Filter Set..... A-5573-S 637E II (SCRAPERS) S/N: 7CB94-165-UP Air Filter Set..... A-5573-S Air Filter Set..... A-5521-S Air Filter Primary..... A-5535 Air Filter Secondary..... A-5534 Air Filter Secondary..... A-5552 Air Filter Primary..... A-5521 637E II (SCRAPERS) S/N: 9PE1-UP Hydraulic Oil Filter..... H-55270 Hydraulic Oil Filter..... H-5504 637 (SCRAPERS) Hydraulic Oil Filter..... H-55320 637 (SCRAPERS) S/N: 63M305-UP Air Filter Secondary..... A-5559 Air Filter Secondary..... A-5520 Air Filter Primary..... A-5543 Air Filter Primary..... A-5558 Air Filter Set..... A-5544-S Fuel Filter Secondary..... FC-5507 Hydraulic Oil Filter..... H-5504 Oil Filter Full Flow..... C-5510 637 (SCRAPERS) S/N: 64M1-UP Air Filter Secondary..... A-5559 Air Filter Set..... A-5544-S Air Filter Primary..... A-5558 Air Filter Primary..... A-5543 Air Filter Secondary..... A-5520 Fuel Filter Secondary..... FC-5507 Hydraulic Oil Filter..... H-5504 Oil Filter Full Flow..... O-5502 637 (SCRAPERS) S/N: 65M1-UP Air Filter Secondary..... A-5526 Air Filter Primary..... A-5557 Air Filter Set..... A-5557-S Fuel Filter Secondary..... FC-5507 Hydraulic Oil Filter..... H-5503 Hydraulic Oil Filter..... H-5504 Oil Filter Full Flow..... O-5503 637 (SCRAPERS) S/N: 79P1-UP Air Filter Set..... A-5557-S Air Filter Primary..... A-5557 Air Filter Secondary..... A-5526 Fuel Filter Secondary..... FC-5507 Hydraulic Oil Filter..... H-5503 Hydraulic Oil Filter..... H-5504 Oil Filter Full Flow..... O-5503		637 (SCRAPERS) S/N: 91N1-373 Air Filter Secondary..... A-5559 Air Filter Secondary..... A-5520 Air Filter Primary..... A-5543 Air Filter Primary..... A-5558 Air Filter Set..... A-5544-S Fuel Filter Secondary..... FC-5507 Hydraulic Oil Filter..... H-5504 Oil Filter Full Flow..... O-5502 637 (SCRAPERS) S/N: 91N374-UP Air Filter Set..... A-5544-S Air Filter Primary..... A-5558 Air Filter Primary..... A-5543 Air Filter Secondary..... A-5520 Air Filter Secondary..... A-5559 Fuel Filter Secondary..... FC-5507 Hydraulic Oil Filter..... H-5504 Oil Filter Full Flow..... C-5510 637 (SCRAPERS) S/N: 92N1-204 Air Filter Secondary..... A-5559 Air Filter Secondary..... A-5520 Air Filter Primary..... A-5543 Air Filter Primary..... A-5558 Air Filter Set..... A-5544-S Fuel Filter Secondary..... FC-5507 Hydraulic Oil Filter..... H-5504 Oil Filter Full Flow..... C-5510 637 (SCRAPERS) S/N: 92N205-UP Air Filter Set..... A-5544-S Air Filter Primary..... A-5558 Air Filter Primary..... A-5543 Air Filter Secondary..... A-5520 Air Filter Secondary..... A-5559 Fuel Filter Secondary..... FC-5507 Hydraulic Oil Filter..... H-5504 Oil Filter Full Flow..... C-5510 637B (SCRAPERS) S/N: 26R1-UP Fuel Filter Secondary..... FC-5507 Oil Filter Full Flow..... C-5510 637D TR (SCRAPERS) S/N: 27W1-UP Air Filter Primary..... A-5521 Air Filter Set..... A-5521-S Air Filter Secondary..... A-5529 Air Filter Primary..... A-5555 Air Filter Set..... A-5555-S Air Filter Secondary..... A-5556 Fuel Filter..... FC-5509 Hydraulic Oil Filter..... H-5504 Oil Filter Full Flow..... C-5516 639D (SCRAPERS) S/N: 88X1-UP Fuel Filter Secondary..... FC-5507	
637E II (SCRAPERS) S/N: 1HB683-UP Air Filter Primary..... A-5535 Air Filter Secondary..... A-5534 Air Filter Secondary..... A-5560 Air Filter Primary..... A-5561 Air Filter Set..... A-5562-S Air Filter Set..... A-5573-S 637E II (SCRAPERS) S/N: 3HB1-UP Hydraulic Oil Filter..... H-55270 637E II (SCRAPERS) S/N: 3KB1-UP Hydraulic Oil Filter..... H-55270 637E II (SCRAPERS) S/N: 7CB166-168-UP Air Filter Set..... A-5521-S Air Filter Secondary..... A-5552 Air Filter Primary..... A-5521 Air Filter Secondary..... A-5534 Air Filter Primary..... A-5535 Air Filter Set..... A-5573-S 637E II (SCRAPERS) S/N: 7CB169-179-UP Air Filter Set..... A-5573-S Air Filter Primary..... A-5535 Air Filter Secondary..... A-5534 Air Filter Secondary..... A-5560 Air Filter Set..... A-5562-S Air Filter Primary..... A-5561 637E II (SCRAPERS) S/N: 7CB180-UP Air Filter Primary..... A-5561 Air Filter Set..... A-5562-S Air Filter Secondary..... A-5560 Air Filter Secondary..... A-5534 Air Filter Primary..... A-5535 Air Filter Set..... A-5573-S 637E II (SCRAPERS) S/N: 7CB1-82-UP Air Filter Set..... A-5573-S Air Filter Primary..... A-5535 Air Filter Secondary..... A-5534 Air Filter Primary..... A-5543 Air Filter Set..... A-5544-S 637E II (SCRAPERS) S/N: 7CB83-83-UP Air Filter Primary..... A-5521 Air Filter Secondary..... A-5529					

MODEL/APPLICATION	SAKURA NO
CATERPILLAR	
639D (SCRAPERS) S/N: 88X1-UP Oil Filter Full Flow.....	C-5510
639D (SCRAPERS) S/N: 99X1-UP Air Filter Secondary.....	A-5529
Air Filter Set.....	A-5521-S
Air Filter Primary.....	A-5521
Air Filter Secondary.....	A-5556
Air Filter Set.....	A-5555-S
Air Filter Primary.....	A-5555
Fuel Filter.....	FC-5509
Hydraulic Oil Filter.....	H-5504
Oil Filter Full Flow.....	C-5516
641 (SCRAPERS) S/N: 41M1-UP Air Filter Secondary.....	A-5520
Air Filter Set.....	A-5544-S
Air Filter Primary.....	A-5558
Air Filter Primary.....	A-5543
Air Filter Secondary.....	A-5559
Fuel Filter.....	F-5501
Hydraulic Oil Filter.....	H-5503
Oil Filter Full Flow.....	O-5503
641 (SCRAPERS) S/N: 64F1-UP Air Filter Secondary.....	A-5559
Air Filter Primary.....	A-5543
Air Filter Primary.....	A-5558
Air Filter Set.....	A-5544-S
Air Filter Secondary.....	A-5520
Fuel Filter.....	F-5501
Hydraulic Oil Filter.....	H-5503
Oil Filter Full Flow.....	O-5503
641B (SCRAPERS) S/N: 65K1-900 Air Filter Secondary.....	A-5520
Air Filter Secondary.....	A-5559
Air Filter Primary.....	A-5543
Air Filter Primary.....	A-5558
Air Filter Set.....	A-5544-S
Fuel Filter Secondary.....	FC-5507
Hydraulic Oil Filter.....	H-5503
Hydraulic Oil Filter.....	H-5504
Oil Filter Full Flow.....	O-5502
641B (SCRAPERS) S/N: 65K901-UP Air Filter Set.....	A-5544-S
Air Filter Primary.....	A-5558
Air Filter Primary.....	A-5543
Air Filter Secondary.....	A-5559
Air Filter Secondary.....	A-5520
Fuel Filter Secondary.....	FC-5507
Hydraulic Oil Filter.....	H-5504
Hydraulic Oil Filter.....	H-5503
Oil Filter Full Flow.....	C-5516
641B (SCRAPERS) w/D346 Eng. Air Filter Secondary.....	A-5520

MODEL/APPLICATION	SAKURA NO
CATERPILLAR	
Hydraulic Oil Filter.....	H-55320
650 (SCRAPERS) S/N: 58K1-354 Air Filter Primary.....	A-5543
Air Filter Secondary.....	A-5559
Air Filter Secondary.....	A-5520
Air Filter Set.....	A-5544-S
Air Filter Primary.....	A-5558
Fuel Filter Secondary.....	FC-5507
Hydraulic Oil Filter.....	H-5503
Hydraulic Oil Filter.....	H-5504
Oil Filter Full Flow.....	O-5502
650 (SCRAPERS) S/N: 58K355-UP Air Filter Primary.....	A-5558
Air Filter Set.....	A-5544-S
Air Filter Secondary.....	A-5520
Air Filter Secondary.....	A-5559
Air Filter Primary.....	A-5543
Fuel Filter Secondary.....	FC-5507
Hydraulic Oil Filter.....	H-5503
Hydraulic Oil Filter.....	H-5504
Oil Filter Full Flow.....	C-5516
650 (SCRAPERS) S/N: 63F1-UP Air Filter Primary.....	A-5543
Air Filter Secondary.....	A-5559
Air Filter Secondary.....	A-5520
Air Filter Set.....	A-5544-S
Air Filter Primary.....	A-5558
Fuel Filter.....	F-5501
Hydraulic Oil Filter.....	H-5503
Oil Filter Full Flow.....	O-5503
650 (SCRAPERS) S/N: 77F1-UP Air Filter Secondary.....	A-5520
Air Filter Primary.....	A-5558
Air Filter Set.....	A-5544-S
Air Filter Secondary.....	A-5559
Air Filter Primary.....	A-5543
Fuel Filter.....	F-5501
Hydraulic Oil Filter.....	H-5503
Oil Filter Full Flow.....	O-5503
650B (SCRAPERS) Hydraulic Oil Filter.....	H-55320
651 (SCRAPERS) S/N: 33G1-UP Air Filter Secondary.....	A-5520
Air Filter Secondary.....	A-5559
Air Filter Primary.....	A-5543
Air Filter Primary.....	A-5558
Air Filter Set.....	A-5544-S
Fuel Filter.....	F-5501
Hydraulic Oil Filter.....	H-5503
Oil Filter Full Flow.....	O-5503
651 (SCRAPERS) S/N: 44M1-UP Air Filter Secondary.....	A-5520

MODEL/APPLICATION	SAKURA NO
CATERPILLAR	
Air Filter Set.....	A-5544-S
Air Filter Primary.....	A-5558
Air Filter Primary.....	A-5543
Air Filter Secondary.....	A-5559
Air Filter Secondary.....	A-5520
Fuel Filter.....	F-5501
Hydraulic Oil Filter.....	H-5503
Oil Filter Full Flow.....	O-5503
651E (SCRAPERS) CAT 3412 (S/N: 88Z1-UP) Air Filter Primary.....	A-5521
Air Filter Set.....	A-5521-S
Air Filter.....	A-5547
Fuel Filter.....	FC-5509
Hydraulic Oil Filter.....	H-5503
Oil Filter Full Flow.....	C-5516
651E (SCRAPERS) CAT 3412 (S/N: 89Z1-UP) Air Filter.....	A-5547
Air Filter Set.....	A-5521-S
Air Filter Primary.....	A-5521
Fuel Filter.....	FC-5509
Hydraulic Oil Filter.....	H-5503
Oil Filter Full Flow.....	C-5516
651E (SCRAPERS) CAT 3412E (S/N: 88Z1-UP) Air Filter Primary.....	A-5521
Air Filter Set.....	A-5521-S
Air Filter.....	A-5547
Fuel Filter.....	FC-5509
Hydraulic Oil Filter.....	H-5503
Oil Filter Full Flow.....	C-5516
651E (SCRAPERS) CAT 3412E (S/N: 89Z1-UP) Air Filter.....	A-5547
Air Filter Set.....	A-5521-S
Air Filter Primary.....	A-5521
Fuel Filter.....	FC-5509
Hydraulic Oil Filter.....	H-5503
Oil Filter Full Flow.....	C-5516
651B (SCRAPERS) S/N: 67K1-508 Air Filter Secondary.....	A-5520
Air Filter Set.....	A-5544-S
Air Filter Primary.....	A-5558
Air Filter Primary.....	A-5543
Air Filter Secondary.....	A-5559
Fuel Filter Secondary.....	FC-5507
Hydraulic Oil Filter.....	H-5503
Hydraulic Oil Filter.....	H-5504
Oil Filter Full Flow.....	O-5503
651B (SCRAPERS) S/N: 67K509-UP Air Filter Primary.....	A-5558
Air Filter Set.....	A-5544-S
Air Filter Secondary.....	A-5520
Air Filter Secondary.....	A-5559
Air Filter Primary.....	A-5543
Fuel Filter Secondary.....	FC-5507

Sakura Filter

ENGINE APPLICATION

MODEL/APPLICATION	SAKURA NO	MODEL/APPLICATION	SAKURA NO	MODEL/APPLICATION	SAKURA NO
CATERPILLAR		CATERPILLAR		CATERPILLAR	
657G (SCRAPERS) S/N: W1B1-UP Hydraulic Oil Filter.....	HC-55300	Oil Filter Full Flow.....	0-5502	Air Filter Set.....	A-5544-S
657G (SCRAPERS) S/N: W1C1-UP Air Filter Set.....	A-5595-S	657B (SCRAPERS) S/N: D346 Eng. Hydraulic Oil Filter.....	H-55320	Air Filter Set.....	A-5549M-S
Air Filter Secondary.....	A-5594	657 (SCRAPERS) S/N: 19G1-UP Air Filter Secondary.....	A-5520	Air Filter Secondary.....	A-5550
Air Filter Primary.....	A-5593	Air Filter Secondary.....	A-5559	Air Filter Primary.....	A-5543
Cabin Air Filter.....	CA-55060	Air Filter Primary.....	A-5543	Air Filter Primary.....	A-5549
Hydraulic Oil Filter.....	HC-55300	Air Filter Primary.....	A-5558	Air Filter Primary.....	A-5549M
657G (SCRAPERS) S/N: W1E1-UP Air Filter Set.....	A-5565-S	Air Filter Set.....	A-5544-S	Air Filter Set.....	A-5573-S
Air Filter Secondary.....	A-5563	Fuel Filter.....	F-5501	Hydraulic Oil Filter.....	HC-5503
Air Filter Primary.....	A-5564	Hydraulic Oil Filter.....	H-5503	Hydraulic Oil Filter.....	HC-5512
657G (SCRAPERS) S/N: W1F105-UP Air Filter Primary.....	A-5564	Oil Filter Full Flow.....	0-5503	Hydraulic Oil Filter.....	HC-5508
Air Filter Secondary.....	A-5563	657 (SCRAPERS) S/N: 31G1-UP Air Filter Set.....	A-5544-S	Hydraulic Oil Filter.....	HC-5506
Air Filter Set.....	A-5565-S	Air Filter Primary.....	A-5558	Oil Filter Full Flow.....	C-5522
657G (SCRAPERS) S/N: W1F1-104-UP Air Filter Set.....	A-5565-S	Air Filter Primary.....	A-5543	Oil Filter Full Flow.....	C-5510
Air Filter Secondary.....	A-5563	Air Filter Secondary.....	A-5559	Oil Filter Full Flow.....	C-5522
Air Filter Primary.....	A-5564	Air Filter Secondary.....	A-5520	65B (TRACTORS) S/N: 7YC1117-UP Air Filter Set.....	A-5573-S
657B (SCRAPERS) S/N: 68K1-826 Air Filter Secondary.....	A-5520	Fuel Filter.....	F-5501	Air Filter Primary.....	A-5549M
Air Filter Set.....	A-5544-S	Hydraulic Oil Filter.....	H-5503	Air Filter Primary.....	A-5549
Air Filter Primary.....	A-5558	Oil Filter Full Flow.....	0-5503	Air Filter Primary.....	A-5543
Air Filter Primary.....	A-5543	657 (SCRAPERS) S/N: 46M1-UP Air Filter Secondary.....	A-5520	Air Filter Secondary.....	A-5550
Air Filter Secondary.....	A-5559	Air Filter Secondary.....	A-5559	Air Filter Secondary.....	A-5554
Fuel Filter Secondary.....	FC-5507	Air Filter Primary.....	A-5543	Air Filter Secondary.....	A-5549M-S
Hydraulic Oil Filter.....	H-5503	Air Filter Primary.....	A-5558	Air Filter Set.....	A-5544-S
Hydraulic Oil Filter.....	H-5504	Air Filter Set.....	A-5544-S	Air Filter Set.....	A-5544-S
Oil Filter Full Flow.....	0-5502	Fuel Filter.....	F-5501	Air Filter Primary.....	A-5535
657B (SCRAPERS) S/N: 68K827-UP Air Filter Secondary.....	A-5559	Hydraulic Oil Filter.....	H-5503	Air Filter Secondary.....	A-5534
Air Filter Primary.....	A-5543	Oil Filter Full Flow.....	0-5503	Hydraulic Oil Filter.....	HC-5506
Air Filter Primary.....	A-5558	657 (SCRAPERS) S/N: 86Z1-87Z1 Air Filter Primary.....	A-5521	Hydraulic Oil Filter.....	HC-5503
Air Filter Set.....	A-5544-S	Air Filter Set.....	A-5521-S	Hydraulic Oil Filter.....	HC-5512
Air Filter Secondary.....	A-5594	Air Filter Secondary.....	A-5529	Oil Filter Full Flow.....	C-5522
Fuel Filter Secondary.....	FC-5507	Hydraulic Oil Filter.....	H-5504	Oil Filter Full Flow.....	C-5516
Hydraulic Oil Filter.....	H-55270	Oil Filter Full Flow.....	C-5516	65C (TRACTORS) S/N: 2ZJ1-499-UP Air Filter Set.....	A-5573-S
Hydraulic Oil Filter.....	H-5504	657 (SCRAPERS) S/N: 90Z1-91Z1 Air Filter Secondary.....	A-5529	Air Filter Primary.....	A-5535
Hydraulic Oil Filter.....	H-5503	Air Filter Set.....	A-5521-S	Air Filter Secondary.....	A-5534
Oil Filter Full Flow.....	0-5502	Air Filter Primary.....	A-5521	Hydraulic Oil Filter.....	HC-5506
657B (SCRAPERS) S/N: 68K829-UP Air Filter Secondary.....	A-5520	Fuel Filter.....	FC-5519	Hydraulic Oil Filter.....	HC-5503
Air Filter Set.....	A-5544-S	Hydraulic Oil Filter.....	H-5503	Hydraulic Oil Filter.....	HC-5512
Air Filter Primary.....	A-5558	Oil Filter Full Flow.....	C-5516	Oil Filter Full Flow.....	C-5522
Air Filter Primary.....	A-5543	65B (TRACTORS) S/N: 08Z32054-UP Fuel Filter Secondary.....	FC-5507	Oil Filter Full Flow.....	C-5516
Air Filter Secondary.....	A-5559	Oil Filter Full Flow.....	C-5522	Oil Filter Full Flow.....	C-5510
Fuel Filter Secondary.....	FC-5507	65B (TRACTORS) S/N: 7YC1-1116-UP Air Filter Secondary.....	A-5534	Oil Filter Full Flow.....	C-5510
Hydraulic Oil Filter.....	H-5503	Air Filter Primary.....	A-5535	65C (TRACTORS) S/N: 2ZJ500-UP Air Filter Set.....	A-5573-S
Hydraulic Oil Filter.....	H-5504	65C (TRACTORS) S/N: 08Z84540-UP Fuel Filter.....	FC-5509	Air Filter Secondary.....	A-5534
Oil Filter Full Flow.....	0-5502	Oil Filter Full Flow.....	C-5522	Air Filter Primary.....	A-5535
				Air Filter Secondary.....	A-5534
				Hydraulic Oil Filter.....	HC-5506
				Hydraulic Oil Filter.....	HC-5503
				Hydraulic Oil Filter.....	HC-5512
				Oil Filter Full Flow.....	C-5516
				Oil Filter Full Flow.....	C-5510
				65C (TRACTORS) S/N: 2ZJ500-UP Air Filter Set.....	A-5573-S
				Air Filter Secondary.....	A-5534
				Air Filter Primary.....	A-5535
				Hydraulic Oil Filter.....	HC-5506
				Hydraulic Oil Filter.....	HC-5503
				Hydraulic Oil Filter.....	HC-5512
				Oil Filter Full Flow.....	C-5516
				Oil Filter Full Flow.....	C-5510

MODEL/APPLICATION	SAKURA NO	MODEL/APPLICATION	SAKURA NO	MODEL/APPLICATION	SAKURA NO
CATERPILLAR		CATERPILLAR		CATERPILLAR	
65C (TRACTORS) S/N: 2ZJ500-UP Oil Filter Full Flow.....	C-5522	65E (TRACTORS) S/N: 16M1-UP Air Filter Primary.....	A-5535	Air Filter Secondary.....	A-5558
65D (TRACTORS) CAT (S/N: 08Z78500-84539-UP) Fuel Filter Secondary.....	FC-5507	Air Filter Secondary.....	A-5534	Air Filter Set.....	A-5544-S
Oil Filter Full Flow.....	C-5522	Air Filter Set.....	A-5573-S	Air Filter Primary.....	A-5543
65D (TRACTORS) CAT (S/N: 08Z84540-UP) Fuel Filter.....	FC-5509	Fuel/Water Separator Secondary..	SFC-5504-10B	Fuel Filter.....	F-5501
Oil Filter Full Flow.....	C-5522	Fuel/Water Separator Secondary...	SFC-5504-10	Hydraulic Oil Filter.....	H-5503
65D (TRACTORS) CAT (S/N: 6NC1-UP) Fuel Filter.....	FC-5509	Hydraulic Oil Filter.....	HC-5512	Oil Filter Full Flow.....	O-5503
Fuel Filter Secondary.....	FC-5507	Hydraulic Oil Filter.....	HC-5503		
Oil Filter Full Flow.....	C-5522	Hydraulic Oil Filter.....	HC-5506		
Oil Filter Full Flow.....	C-5516				
65D (TRACTORS) S/N: 2ZJ1000-UP Air Filter Primary.....	A-5535	660 (TRACTORS) S/N: 6GS1-UP Air Filter Primary.....	A-5535	666 (SCRAPERS) S/N: 20G1-241 Air Filter Primary.....	A-5543
Air Filter Set.....	A-5573-S	Air Filter Set.....	A-5573-S	Air Filter Set.....	A-5544-S
Air Filter Secondary.....	A-5534	Air Filter Secondary.....	A-5534	Air Filter Primary.....	A-5558
Hydraulic Oil Filter.....	HC-5506	Fuel/Water Separator Secondary...	SFC-5504-10	Air Filter Secondary.....	A-5559
Hydraulic Oil Filter.....	HC-5503	Fuel/Water Separator Secondary..	SFC-5504-10B	Air Filter Secondary.....	A-5520
Hydraulic Oil Filter.....	HC-5512	Hydraulic Oil Filter.....	HC-5506	Fuel Filter.....	F-5501
65D (TRACTORS) S/N: 2ZJ1-999-UP Air Filter Secondary.....	A-5534	Hydraulic Oil Filter.....	HC-5503	Hydraulic Oil Filter.....	H-5503
Air Filter Set.....	A-5573-S	Oil Filter Full Flow.....	O-5502	Oil Filter Full Flow.....	O-5503
Air Filter Primary.....	A-5535	660 (SCRAPERS) S/N: 58K1-354 Air Filter Secondary.....	A-5520	Air Filter Primary.....	A-5543
Hydraulic Oil Filter.....	HC-5512	Air Filter Primary.....	A-5543	Fuel Filter.....	F-5501
Hydraulic Oil Filter.....	HC-5503	Air Filter Set.....	A-5544-S	Hydraulic Oil Filter.....	H-5503
Hydraulic Oil Filter.....	HC-5506	Air Filter Primary.....	A-5558	Oil Filter Full Flow.....	O-5503
65E (TRACTORS) CAT (S/N: 7ZR575-648-UP) Fuel Filter.....	FC-5517	Air Filter Secondary.....	A-5559		
65E (TRACTORS) CAT S/N: 7ZR1450-4252-UP Fuel Filter.....	FC-5517	Fuel Filter Secondary.....	FC-5507	666 (SCRAPERS) S/N: 32G1-UP Air Filter Secondary.....	A-5520
Oil Filter Full Flow.....	C-5516	Hydraulic Oil Filter.....	H-5503	Air Filter Secondary.....	A-5559
65E (TRACTORS) CAT S/N: 7ZR4253-4280-UP Fuel Filter.....	FC-5517	Hydraulic Oil Filter.....	H-5504	Air Filter Primary.....	A-5558
Oil Filter Full Flow.....	C-5516	Oil Filter Full Flow.....	O-5502	Air Filter Secondary.....	A-5559
65E (TRACTORS) CAT S/N: 7ZR4281-5544-UP Fuel Filter.....	FC-5517	660 (SCRAPERS) S/N: 77F1-UP Air Filter Secondary.....	A-5520	Air Filter Primary.....	A-5543
Oil Filter Full Flow.....	C-5516	Air Filter Primary.....	A-5543	Air Filter Secondary.....	A-5520
65E (TRACTORS) CAT S/N: 7ZR5545-UP Fuel Filter.....	FC-5517	Air Filter Set.....	A-5544-S	Air Filter Set.....	A-5544-S
Oil Filter Full Flow.....	C-5516	Air Filter Primary.....	A-5558	Air Filter Primary.....	A-5543
65E (TRACTORS) CAT S/N: 7ZR649-1449-UP Fuel Filter.....	FC-5517	Air Filter Secondary.....	A-5559	Fuel Filter.....	F-5501
Oil Filter Full Flow.....	C-5516	Fuel Filter.....	F-5501	Hydraulic Oil Filter.....	H-5503
		Hydraulic Oil Filter.....	H-5503	Oil Filter Full Flow.....	O-5503
		Oil Filter Full Flow.....	O-5503		
		660B (SCRAPERS) Hydraulic Oil Filter.....	H-55320	666B (SCRAPERS) S/N: 66K1-226 Air Filter Secondary.....	A-5520
		666 (SCRAPERS) S/N: 18G1-UP Air Filter Secondary.....	A-5520	Air Filter Primary.....	A-5543
				Air Filter Set.....	A-5544-S
				Air Filter Primary.....	A-5558
				Air Filter Secondary.....	A-5559
				Fuel Filter Secondary.....	FC-5507
				Hydraulic Oil Filter.....	H-5503
				Hydraulic Oil Filter.....	H-5504
				Hydraulic Oil Filter.....	H-55270
				Hydraulic Oil Filter.....	H-55280

MODEL/APPLICATION	SAKURA NO
CATERPILLAR	
666B (SCRAPERS) S/N: 66K1-226 Oil Filter Full Flow.....	0-5502
666B (SCRAPERS) S/N: 66K227-UP Air Filter Primary.....	A-5558
Air Filter Set.....	A-5544-S
Air Filter Primary.....	A-5543
Air Filter Secondary.....	A-5520
Air Filter Secondary.....	A-5559
Fuel Filter Secondary.....	FC-5507
Hydraulic Oil Filter.....	H-5504
Hydraulic Oil Filter.....	H-5503
Oil Filter Full Flow.....	C-5516
70C (TRACTORS) CAT (S/N: 08Z72400-UP) Fuel Filter Secondary.....	FC-5507
Oil Filter Full Flow.....	C-5522
70C (TRACTORS) S/N: 2YL1-UP Air Filter Secondary.....	A-5534
Air Filter Primary.....	A-5535
Air Filter Set.....	A-5573-S
Hydraulic Oil Filter.....	HC-5503
Hydraulic Oil Filter.....	HC-5512
Hydraulic Oil Filter.....	HC-5506
Oil Filter Full Flow.....	C-5510
Oil Filter Full Flow.....	C-5522
725 (ARTICULATED TRUCKS) CAT 3176C Air Filter Secondary.....	A-8651
Fuel Filter.....	FC-5517
Fuel/Water Separator Secondary..	SFC-5504-10
Fuel/Water Separator Secondary..	SFC-5504-10B
Hydraulic Oil Filter.....	H-5526
Hydraulic Oil Filter.....	HC-5507
Oil Filter Full Flow.....	C-5516
725 (ARTICULATED TRUCKS) CAT C11 Air Filter Secondary.....	A-8651
Fuel Filter.....	FC-5517
Fuel/Water Separator Secondary..	SFC-5504-10B
Fuel/Water Separator Secondary..	SFC-5504-10
Hydraulic Oil Filter.....	HC-5507
Hydraulic Oil Filter.....	H-5526
Oil Filter Full Flow.....	C-5516
725 (ARTICULATED TRUCKS) S/N: AFX1-1178 Air Filter Secondary.....	A-8651
Cabin Air Filter.....	CA-55060
Fuel/Water Separator Secondary..	SFC-5504-10
Fuel/Water Separator Secondary..	SFC-5504-10B
Hydraulic Oil Filter.....	H-5526
Hydraulic Oil Filter.....	H-5503
Hydraulic Oil Filter.....	HC-5507
Hydraulic Oil Filter.....	HC-55220
Hydraulic Oil Filter.....	H-55280

MODEL/APPLICATION	SAKURA NO
CATERPILLAR	
725 (ARTICULATED TRUCKS) S/N: AFX1179-1582 Air Filter Secondary.....	A-8651
Cabin Air Filter.....	CA-55060
Fuel/Water Separator Secondary..	SFC-5504-10B
Fuel/Water Separator Secondary..	SFC-5504-10
Hydraulic Oil Filter.....	HC-55220
Hydraulic Oil Filter.....	HC-5507
Hydraulic Oil Filter.....	H-5503
Hydraulic Oil Filter.....	H-5526
Hydraulic Oil Filter.....	H-55280
725 (ARTICULATED TRUCKS) S/N: AFX1583-UP Air Filter Secondary.....	A-8651
Cabin Air Filter.....	CA-55060
Fuel/Water Separator Secondary..	SFC-5504-10
Fuel/Water Separator Secondary..	SFC-5504-10B
Hydraulic Oil Filter.....	H-5526
Hydraulic Oil Filter.....	H-5503
Hydraulic Oil Filter.....	HC-5507
Hydraulic Oil Filter.....	HC-55220
Hydraulic Oil Filter.....	H-55280
725 (ARTICULATED TRUCKS) S/N: AFX1-UP Cabin Air Filter.....	CA-55160
725 (ARTICULATED TRUCKS) S/N: B1L1-504 Air Filter Secondary.....	A-8651
Cabin Air Filter.....	CA-55060
Fuel/Water Separator Secondary..	SFC-5504-10B
Fuel/Water Separator Secondary..	SFC-5504-10
Hydraulic Oil Filter.....	HC-55220
Hydraulic Oil Filter.....	HC-5507
Hydraulic Oil Filter.....	H-5503
Hydraulic Oil Filter.....	H-5526
Hydraulic Oil Filter.....	H-55280
725 (ARTICULATED TRUCKS) S/N: B1L505-711 Air Filter Secondary.....	A-8651
Cabin Air Filter.....	CA-55060
Fuel/Water Separator Secondary..	SFC-5504-10
Fuel/Water Separator Secondary..	SFC-5504-10B
Hydraulic Oil Filter.....	H-55280
Hydraulic Oil Filter.....	H-5526
Hydraulic Oil Filter.....	HC-5504
730 (ARTICULATED TRUCKS) CAT 3196C Air Filter Secondary.....	A-8651
Fuel Filter.....	FC-5517
Fuel/Water Separator Secondary..	SFC-5504-10B
Fuel/Water Separator Secondary..	SFC-5504-10
Hydraulic Oil Filter.....	H-5526
Hydraulic Oil Filter.....	HC-5507
Oil Filter Full Flow.....	C-5516
730 (ARTICULATED TRUCKS) CAT C11 Air Filter Secondary.....	A-8651
Fuel Filter.....	FC-5517

MODEL/APPLICATION	SAKURA NO
CATERPILLAR	
Fuel/Water Separator Secondary..	SFC-5504-10
Fuel/Water Separator Secondary..	SFC-5504-10B
Hydraulic Oil Filter.....	H-5526
Hydraulic Oil Filter.....	HC-5507
Oil Filter Full Flow.....	C-5516
730 (ARTICULATED TRUCKS) S/N: AGF1092-1491 Air Filter Secondary.....	A-8651
Cabin Air Filter.....	CA-55060
Fuel/Water Separator Secondary..	SFC-5504-10B
Fuel/Water Separator Secondary..	SFC-5504-10
Hydraulic Oil Filter.....	H-55280
Hydraulic Oil Filter.....	HC-5507
Hydraulic Oil Filter.....	HC-55220
Hydraulic Oil Filter.....	H-5526
730 (ARTICULATED TRUCKS) S/N: AGF1-1091 Air Filter Secondary.....	A-8651
Cabin Air Filter.....	CA-55060
Fuel/Water Separator Secondary..	SFC-5504-10
Fuel/Water Separator Secondary..	SFC-5504-10B
Hydraulic Oil Filter.....	H-5526
Hydraulic Oil Filter.....	HC-55220
Hydraulic Oil Filter.....	HC-5507
Hydraulic Oil Filter.....	H-55280
Hydraulic Oil Filter.....	H-5503
730 (ARTICULATED TRUCKS) S/N: AGF1492-UP Air Filter Secondary.....	A-8651
Cabin Air Filter.....	CA-55060
Fuel/Water Separator Secondary..	SFC-5504-10B
Fuel/Water Separator Secondary..	SFC-5504-10
Hydraulic Oil Filter.....	H-55280
Hydraulic Oil Filter.....	HC-5507
Hydraulic Oil Filter.....	HC-55220
Hydraulic Oil Filter.....	H-5526
730 (ARTICULATED TRUCKS) S/N: B1M1-410 Air Filter Secondary.....	A-8651
Cabin Air Filter.....	CA-55060
Fuel/Water Separator Secondary..	SFC-5504-10B
Fuel/Water Separator Secondary..	SFC-5504-10
Hydraulic Oil Filter.....	H-5526
Hydraulic Oil Filter.....	HC-55220
Hydraulic Oil Filter.....	HC-5507
Hydraulic Oil Filter.....	H-55280
730 (ARTICULATED TRUCKS) S/N: B1M411-630 Air Filter Secondary.....	A-8651
Cabin Air Filter.....	CA-55060
Fuel/Water Separator Secondary..	SFC-5504-10B
Fuel/Water Separator Secondary..	SFC-5504-10
Hydraulic Oil Filter.....	H-5526
Hydraulic Oil Filter.....	HC-5507
Hydraulic Oil Filter.....	H-55280
Hydraulic Oil Filter.....	HC-5504
730 (ARTICULATED TRUCKS) S/N: B1W1-184 Air Filter Secondary.....	A-8651
Cabin Air Filter.....	CA-55060

MODEL/APPLICATION	SAKURA NO
CATERPILLAR	
730 (ARTICULATED TRUCKS) S/N: B1W1-184	
Fuel/Water Separator Secondary..	SFC-5504-10
Fuel/Water Separator Secondary..	SFC-5504-10B
Hydraulic Oil Filter.....	H-5526
Hydraulic Oil Filter.....	H-55280
Hydraulic Oil Filter.....	HC-5507
Hydraulic Oil Filter.....	HC-55220
730 (ARTICULATED TRUCKS) S/N: B1W185-196	
Air Filter Secondary.....	A-8651
Cabin Air Filter.....	CA-55060
Fuel/Water Separator Secondary..	SFC-5504-10B
Fuel/Water Separator Secondary..	SFC-5504-10
Hydraulic Oil Filter.....	H-5526
Hydraulic Oil Filter.....	H-55280
Hydraulic Oil Filter.....	HC-5504
730 (ARTICULATED TRUCKS) S/N: B1M1-UP	
Cabin Air Filter.....	CA-55160
735 (ARTICULATED TRUCKS) CAT 3406E	
Air Filter Secondary.....	A-8580
Air Filter Primary.....	A-8665M
Air Filter.....	AH-7001
Fuel Filter.....	FC-5509
Fuel/Water Separator Secondary..	SFC-5504-10
Fuel/Water Separator Secondary..	SFC-5504-10B
Hydraulic Oil Filter.....	H-5526
Hydraulic Oil Filter.....	HC-5507
Oil Filter Full Flow.....	C-5516
735 (ARTICULATED TRUCKS) CAT C15	
Air Filter.....	AH-7001
Air Filter Primary.....	A-8665M
Air Filter Secondary.....	A-8580
Fuel Filter.....	FC-5517
Fuel/Water Separator Secondary..	SFC-5504-10B
Fuel/Water Separator Secondary..	SFC-5504-10
Hydraulic Oil Filter.....	HC-5507
Hydraulic Oil Filter.....	H-5526
Oil Filter Full Flow.....	C-5516
735 (ARTICULATED TRUCKS) S/N: AWR1-856	
Air Filter Secondary.....	A-8580
Air Filter Primary.....	A-8665M
Cabin Air Filter.....	CA-55060
Hydraulic Oil Filter.....	H-55280
Hydraulic Oil Filter.....	H-5526
Hydraulic Oil Filter.....	HC-5507
Hydraulic Oil Filter.....	HC-55220
735 (ARTICULATED TRUCKS) S/N: AWR857-UP	
Air Filter Primary.....	A-8665M
Air Filter Secondary.....	A-8580
Cabin Air Filter.....	CA-55060
Hydraulic Oil Filter.....	HC-55220
Hydraulic Oil Filter.....	HC-5507

MODEL/APPLICATION	SAKURA NO
CATERPILLAR	
Hydraulic Oil Filter.....	H-5526
Hydraulic Oil Filter.....	H-55280
735 (ARTICULATED TRUCKS) S/N: B1N1-436	
Air Filter Secondary.....	A-8580
Air Filter Primary.....	A-8665M
Cabin Air Filter.....	CA-55060
Hydraulic Oil Filter.....	H-55280
Hydraulic Oil Filter.....	H-5526
Hydraulic Oil Filter.....	HC-5507
Hydraulic Oil Filter.....	HC-55220
740 (ARTICULATED TRUCKS) CAT 3406E	
Air Filter Primary.....	A-8665M
Air Filter Secondary.....	A-8580
Air Filter.....	AH-7001
Fuel Filter.....	FC-5509
Fuel/Water Separator Secondary..	SFC-5504-10B
Fuel/Water Separator Secondary..	SFC-5504-10
Hydraulic Oil Filter.....	HC-5507
Hydraulic Oil Filter.....	H-5526
Hydraulic Oil Filter.....	H-55270
Hydraulic Oil Filter.....	H-5504
Oil Filter Full Flow.....	C-5516
740 (ARTICULATED TRUCKS) CAT C15	
Air Filter.....	AH-7001
Air Filter Secondary.....	A-8580
Air Filter Primary.....	A-8665M
Fuel Filter.....	FC-5517
Fuel/Water Separator Secondary..	SFC-5504-10
Fuel/Water Separator Secondary..	SFC-5504-10B
Hydraulic Oil Filter.....	H-5504
Hydraulic Oil Filter.....	H-5526
Hydraulic Oil Filter.....	HC-5507
Oil Filter Full Flow.....	C-5516
740 (ARTICULATED TRUCKS) S/N: AXM1-UP	
Air Filter Primary.....	A-8665M
Air Filter Secondary.....	A-8580
Cabin Air Filter.....	CA-55060
Hydraulic Oil Filter.....	HC-55220
Hydraulic Oil Filter.....	HC-5507
Hydraulic Oil Filter.....	H-5526
Hydraulic Oil Filter.....	H-55270
Hydraulic Oil Filter.....	H-55280
740 (ARTICULATED TRUCKS) S/N: AZZ1-UP	
Air Filter Secondary.....	A-8580
Air Filter Primary.....	A-8665M
Cabin Air Filter.....	CA-55060
Hydraulic Oil Filter.....	H-55280
Hydraulic Oil Filter.....	H-55270
Hydraulic Oil Filter.....	H-5526
Hydraulic Oil Filter.....	HC-5507
Hydraulic Oil Filter.....	HC-55220
740 (ARTICULATED TRUCKS) S/N: B1P1-1073	

MODEL/APPLICATION	SAKURA NO
CATERPILLAR	
Air Filter Primary.....	A-8665M
Air Filter Secondary.....	A-8580
Cabin Air Filter.....	CA-55060
Hydraulic Oil Filter.....	HC-55220
Hydraulic Oil Filter.....	HC-5507
Hydraulic Oil Filter.....	H-5526
Hydraulic Oil Filter.....	H-55270
Hydraulic Oil Filter.....	H-55280
740 (ARTICULATED TRUCKS) S/N: B1R1-219	
Air Filter Secondary.....	A-8580
Air Filter Primary.....	A-8665M
Cabin Air Filter.....	CA-55060
Hydraulic Oil Filter.....	H-55280
Hydraulic Oil Filter.....	H-55270
Hydraulic Oil Filter.....	H-5526
Hydraulic Oil Filter.....	HC-5507
Hydraulic Oil Filter.....	HC-55220
75 (TRACTORS) CAT S/N: 43Z1-UP	
Air Filter Primary.....	A-5501
Air Filter Secondary.....	A-5502
Fuel Filter.....	FC-5509
Hydraulic Oil Filter.....	HC-5512
Hydraulic Oil Filter.....	HC-5506
Hydraulic Oil Filter.....	HC-5508
Hydraulic Oil Filter.....	HC-5503
Oil Filter Full Flow.....	C-5516
75 (TRACTORS) CAT S/N: 4CJ1-UP	
Air Filter Secondary.....	A-5502
Air Filter Primary.....	A-5501
Fuel Filter.....	FC-5509
Hydraulic Oil Filter.....	HC-5503
Hydraulic Oil Filter.....	HC-5508
Hydraulic Oil Filter.....	HC-5506
Hydraulic Oil Filter.....	HC-5512
Oil Filter Full Flow.....	C-5516
75C (TRACTORS) CAT (S/N: 43Z2487-UP)	
Fuel Filter.....	FC-5509
Oil Filter Full Flow.....	C-5516
75C (TRACTORS) CAT (S/N: 43Z490-2486-UP)	
Fuel Filter.....	FC-5509
Oil Filter Full Flow.....	C-5516
75C (TRACTORS) S/N: 4KK1-499-UP	
Air Filter Primary.....	A-5535
Air Filter Set.....	A-5573-S
Air Filter Secondary.....	A-5534
Hydraulic Oil Filter.....	HC-5503
Hydraulic Oil Filter.....	HC-5512
Hydraulic Oil Filter.....	HC-5506
75C (TRACTORS) S/N: 4KK500-UP	
Air Filter Secondary.....	A-5534
Air Filter Set.....	A-5573-S

MODEL/APPLICATION	SAKURA NO
CATERPILLAR	
75C (TRACTORS) S/N: 4KK500-UP	
Air Filter Primary.....	A-5535
Hydraulic Oil Filter.....	HC-5506
Hydraulic Oil Filter.....	HC-5512
Hydraulic Oil Filter.....	HC-5503
75D (TRACTORS) CAT S/N: 5AR1-UP	
Air Filter Primary.....	A-5535
Air Filter Secondary.....	A-5534
Air Filter Set.....	A-5573-S
Fuel Filter.....	FC-5509
Fuel Filter.....	FC-5517
Fuel/Water Separator Secondary..	SFC-5504-10
Fuel/Water Separator Secondary..	SFC-5504-10B
Hydraulic Oil Filter.....	HC-5506
Hydraulic Oil Filter.....	HC-5512
Hydraulic Oil Filter.....	HC-5503
Oil Filter Full Flow.....	C-5516
75D (TRACTORS) CAT S/N: 7ZR1-UP	
Air Filter Set.....	A-5573-S
Air Filter Secondary.....	A-5534
Air Filter Primary.....	A-5535
Fuel Filter.....	FC-5517
Fuel Filter.....	FC-5509
Fuel/Water Separator Secondary..	SFC-5504-10B
Fuel/Water Separator Secondary..	SFC-5504-10
Hydraulic Oil Filter.....	HC-5503
Hydraulic Oil Filter.....	HC-5512
Hydraulic Oil Filter.....	HC-5506
Oil Filter Full Flow.....	C-5516
75E (TRACTORS) CAT S/N: 7ZR1450-4252-UP	
Fuel Filter.....	FC-5517
Oil Filter Full Flow.....	C-5516
75E (TRACTORS) CAT S/N: 7ZR4253-4280-UP	
Fuel Filter.....	FC-5517
Oil Filter Full Flow.....	C-5516
75E (TRACTORS) CAT S/N: 7ZR4281-5544-UP	
Fuel Filter.....	FC-5517
Oil Filter Full Flow.....	C-5516
75E (TRACTORS) CAT S/N: 7ZR5545-UP	
Fuel Filter.....	FC-5517
Oil Filter Full Flow.....	C-5516
75E (TRACTORS) CAT S/N: 7ZR575-1449-UP	
Fuel Filter.....	FC-5517
Oil Filter Full Flow.....	C-5516
75E (TRACTORS) S/N: 1HM1-UP	
Air Filter Primary.....	A-5535
Air Filter Set.....	A-5573-S
Air Filter Secondary.....	A-5534

MODEL/APPLICATION	SAKURA NO
CATERPILLAR	
Fuel/Water Separator Secondary..	SFC-5504-10B
Fuel/Water Separator Secondary..	SFC-5504-10
Hydraulic Oil Filter.....	HC-5503
Hydraulic Oil Filter.....	HC-5512
Hydraulic Oil Filter.....	HC-5506
75E (TRACTORS) S/N: 6HS1-UP	
Air Filter Secondary.....	A-5534
Air Filter Set.....	A-5573-S
Air Filter Primary.....	A-5535
Fuel/Water Separator Secondary..	SFC-5504-10
Fuel/Water Separator Secondary..	SFC-5504-10B
Hydraulic Oil Filter.....	HC-5503
Hydraulic Oil Filter.....	HC-5506
Hydraulic Oil Filter.....	HC-5512
75E US (TRACTORS) CAT 3176	
Hydraulic Oil Filter.....	H-5507
768C (DUMP TRUCKS) CAT 3408	
Fuel Filter.....	FC-5519
Oil Filter Full Flow.....	C-5516
768B (DUMP TRUCKS) S/N: 79S1-UP	
Oil Filter Full Flow.....	O-5503
769D (DUMP TRUCKS) CAT 3408E (S/N: 5TR1-504) , 2005-UP	
Air Filter Secondary.....	A-5556
Air Filter Set.....	A-5555-S
Air Filter Primary.....	A-5555
Fuel Filter.....	FC-5509
Fuel/Water Separator Secondary..	SFC-5504-10
Fuel/Water Separator Secondary..	SFC-5504-10B
Hydraulic Oil Filter.....	HC-5504
Hydraulic Oil Filter.....	HC-5516
Oil Filter Full Flow.....	C-5516
769D (DUMP TRUCKS) CAT 3408E (S/N: 5SS-UP)	
Air Filter Secondary.....	A-5556
Air Filter Set.....	A-5555-S
Air Filter Primary.....	A-5555
Coolant Filter.....	WC-5707
Fuel Filter.....	FC-5509
Hydraulic Oil Filter.....	H-5503
Hydraulic Oil Filter.....	HC-5504
Oil Filter Full Flow.....	C-5516
769D (DUMP TRUCKS) CAT 3408E (S/N: 5TR-UP)	
Air Filter Primary.....	A-5555
Air Filter Set.....	A-5555-S
Air Filter Secondary.....	A-5556
Coolant Filter.....	WC-5707
Fuel Filter.....	FC-5509
Hydraulic Oil Filter.....	H-5503
Hydraulic Oil Filter.....	HC-5504
Oil Filter Full Flow.....	C-5516
769D (DUMP TRUCKS) CAT 3408E (S/N: 8BB-UP)	
Air Filter Primary.....	A-5555
Air Filter Set.....	A-5555-S
Air Filter Secondary.....	A-5556
Coolant Filter.....	WC-5707
Fuel Filter.....	FC-5509
Hydraulic Oil Filter.....	H-5503
Hydraulic Oil Filter.....	HC-5504
Oil Filter Full Flow.....	C-5516

MODEL/APPLICATION	SAKURA NO
CATERPILLAR	
Air Filter Secondary.....	A-5556
Air Filter Set.....	A-5555-S
Air Filter Primary.....	A-5555
Coolant Filter.....	WC-5707
Fuel Filter.....	FC-5509
Hydraulic Oil Filter.....	H-5503
Hydraulic Oil Filter.....	HC-5504
Oil Filter Full Flow.....	C-5516
769D (DUMP TRUCKS) CAT 3408E TA-HEUI (S/N: 5SS1-UP)	
Air Filter Set.....	A-5555-S
Air Filter Secondary.....	A-5556
Air Filter Primary.....	A-5555
Fuel Filter.....	FC-5509
Hydraulic Oil Filter.....	HC-5505
Hydraulic Oil Filter.....	HC-5504
Hydraulic Oil Filter.....	HC-55300
Hydraulic Oil Filter.....	HC-5516
Hydraulic Oil Filter.....	HC-55170
Oil Filter Full Flow.....	C-5516
769D (DUMP TRUCKS) CAT 3408E TA-HEUI (S/N: 5TR1-504)	
Air Filter Secondary.....	A-5556
Air Filter Set.....	A-5555-S
Air Filter Primary.....	A-5555
Fuel Filter.....	FC-5509
Hydraulic Oil Filter.....	HC-5516
Hydraulic Oil Filter.....	HC-55300
Hydraulic Oil Filter.....	HC-5504
Oil Filter Full Flow.....	C-5516
769D (DUMP TRUCKS) CAT 3408E TA-HEUI (S/N: 5TR1-UP)	
Fuel Filter.....	FC-5509
Hydraulic Oil Filter.....	H-5503
Oil Filter Full Flow.....	C-5516
769D (DUMP TRUCKS) CAT 3408E TA-HEUI (S/N: 5TR505-UP)	
Air Filter Primary.....	A-5555
Air Filter Set.....	A-5555-S
Air Filter Secondary.....	A-5556
Fuel Filter.....	FC-5509
Hydraulic Oil Filter.....	H-5503
Hydraulic Oil Filter.....	H-55280
Hydraulic Oil Filter.....	H-55270
Hydraulic Oil Filter.....	H-5526
Hydraulic Oil Filter.....	H-5504
Oil Filter Full Flow.....	C-5516
769D (DUMP TRUCKS) CAT 3408E TA-HEUI (S/N: BBB1-UP)	
Air Filter Secondary.....	A-5556
Air Filter Set.....	A-5555-S
Air Filter Primary.....	A-5555
Fuel Filter.....	FC-5509
Hydraulic Oil Filter.....	HC-5504
Hydraulic Oil Filter.....	HC-55300
Hydraulic Oil Filter.....	HC-5516
Hydraulic Oil Filter.....	HC-5505
Hydraulic Oil Filter.....	HC-55170
Oil Filter Full Flow.....	C-5516

Sakura Filter

ENGINE APPLICATION

MODEL/APPLICATION	SAKURA NO
CATERPILLAR	
769D (DUMP TRUCKS)	
Fuel/Water Separator Primary.....	SFC-5504-30
Fuel/Water Separator Primary....	SFC-5504-30B
769 (DUMP TRUCKS) S/N: 1X1-UP	
Air Filter Secondary.....	A-5529
Air Filter Set.....	A-5521-S
Air Filter Primary.....	A-5521
Fuel Filter.....	FC-5519
Hydraulic Oil Filter.....	H-5503
Hydraulic Oil Filter.....	H-5504
Oil Filter Full Flow.....	C-5516
769 (DUMP TRUCKS) S/N: 99F1-1229	
Air Filter Primary.....	A-5543
Air Filter Set.....	A-5544-S
Air Filter Secondary.....	A-5520
Hydraulic Oil Filter.....	H-55280
Hydraulic Oil Filter.....	H-5503
Oil Filter Full Flow.....	O-5503
769 (DUMP TRUCKS) S/N: 99F1230-UP	
Air Filter Secondary.....	A-5520
Air Filter Set.....	A-5544-S
Air Filter Primary.....	A-5543
Hydraulic Oil Filter.....	H-5503
Oil Filter Full Flow.....	O-5503
769 (DUMP TRUCKS) S/N: 99F1231-1237	
Air Filter Primary.....	A-5543
Air Filter Set.....	A-5544-S
Air Filter Secondary.....	A-5520
Hydraulic Oil Filter.....	H-55280
Hydraulic Oil Filter.....	H-5503
Oil Filter Full Flow.....	O-5503
769 (DUMP TRUCKS) S/N: 99F1238-UP	
Air Filter Secondary.....	A-5520
Air Filter Set.....	A-5544-S
Air Filter Primary.....	A-5543
Hydraulic Oil Filter.....	H-5503
Hydraulic Oil Filter.....	H-55280
Oil Filter Full Flow.....	O-5503
769B (DUMP TRUCKS) S/N: 99F1-1229	
Air Filter Secondary.....	A-5520
Air Filter Primary.....	A-5543
Air Filter Set.....	A-5544-S
Air Filter Primary.....	A-5558
Air Filter Secondary.....	A-5559
Fuel Filter.....	F-5501
Hydraulic Oil Filter.....	H-5503
Oil Filter Full Flow.....	O-5503
769B (DUMP TRUCKS) S/N: 99F1230-UP	
Air Filter Set.....	A-5544-S

MODEL/APPLICATION	SAKURA NO
CATERPILLAR	
Air Filter Primary.....	A-5543
Air Filter Secondary.....	A-5520
Air Filter Secondary.....	A-5559
Air Filter Primary.....	A-5558
Fuel Filter Secondary.....	FC-5507
Hydraulic Oil Filter.....	H-5503
Oil Filter Full Flow.....	O-5503
769C (DUMP TRUCKS) CAT 3408 (S/N: 01X02877-05473) , 2005-UP	
Air Filter Primary.....	A-5521
Air Filter Set.....	A-5521-S
Air Filter Secondary.....	A-5529
Fuel Filter.....	FC-5509
Hydraulic Oil Filter.....	H-5503
Hydraulic Oil Filter.....	H-5504
Oil Filter Full Flow.....	C-5516
769C (DUMP TRUCKS) CAT 3408 (S/N: 01X05474-06324) , 2005-UP	
Air Filter Secondary.....	A-5529
Air Filter Set.....	A-5521-S
Air Filter Primary.....	A-5521
Fuel Filter.....	FC-5509
Hydraulic Oil Filter.....	H-5504
Hydraulic Oil Filter.....	H-5503
Oil Filter Full Flow.....	C-5516
769C (DUMP TRUCKS) CAT 3408 (S/N: 01X06325-06599) , 2005-UP	
Air Filter Secondary.....	A-5556
Air Filter Primary.....	A-5555
Air Filter Set.....	A-5555-S
Fuel Filter.....	FC-5509
Hydraulic Oil Filter.....	H-5503
Hydraulic Oil Filter.....	H-5504
Oil Filter Full Flow.....	C-5516
769C (DUMP TRUCKS) CAT 3408 (S/N: 01X1-02876) , 2005-UP	
Air Filter Set.....	A-5521-S
Air Filter Secondary.....	A-5529
Air Filter Primary.....	A-5521
Fuel Filter.....	FC-5509
Hydraulic Oil Filter.....	H-5504
Hydraulic Oil Filter.....	H-5503
769C (DUMP TRUCKS) S/N: 1X6325-UP	
Air Filter Set.....	A-5555-S
Air Filter Primary.....	A-5555
Air Filter Secondary.....	A-5529
Air Filter Secondary.....	A-5556

MODEL/APPLICATION	SAKURA NO
CATERPILLAR	
Air Filter Primary.....	A-5521
Air Filter Set.....	A-5521-S
Fuel Filter.....	FC-5519
Fuel Filter.....	FC-5509
Hydraulic Oil Filter.....	H-5503
Oil Filter Full Flow.....	C-5516
769D US (DUMP TRUCKS) CAT 3408E (S/N: 5TR1-UP) , 2005-UP	
Air Filter Set.....	A-5555-S
Air Filter Primary.....	A-5555
Air Filter Secondary.....	A-5556
Air Filter.....	AH-7001
Fuel Filter.....	FC-5509
Fuel/Water Separator Secondary..	SFC-5504-10B
Fuel/Water Separator Secondary..	SFC-5504-10
Hydraulic Oil Filter.....	H-5504
Hydraulic Oil Filter.....	H-5503
Oil Filter Full Flow.....	C-5516
771D (DUMP TRUCKS) CAT 3408E (S/N: 6JR1-UP) , 2005-UP	
Air Filter Secondary.....	A-5556
Air Filter Primary.....	A-5555
Air Filter Set.....	A-5555-S
Fuel Filter.....	FC-5509
Fuel/Water Separator Secondary..	SFC-5504-10
Fuel/Water Separator Secondary..	SFC-5504-10B
Hydraulic Oil Filter.....	H-5503
Hydraulic Oil Filter.....	H-5504
Oil Filter Full Flow.....	C-5516
771D (DUMP TRUCKS) CAT 3408E (S/N: 6YS1-UP) , 2005-UP	
Air Filter Set.....	A-5555-S
Air Filter Primary.....	A-5555
Air Filter Secondary.....	A-5556
Fuel Filter.....	FC-5509
Fuel/Water Separator Secondary..	SFC-5504-10B
Fuel/Water Separator Secondary..	SFC-5504-10
Hydraulic Oil Filter.....	HC-5504
Hydraulic Oil Filter.....	HC-5516
Hydraulic Oil Filter.....	HC-5505
Oil Filter Full Flow.....	C-5516
771D (DUMP TRUCKS) CAT 3408E (S/N: BCA1-UP)	
Air Filter Primary.....	A-5555
Air Filter Set.....	A-5555-S
Air Filter Secondary.....	A-5556
Air Filter.....	AH-7001
Fuel Filter.....	FC-5509
Fuel/Water Separator Secondary..	SFC-5504-10B
Fuel/Water Separator Secondary..	SFC-5504-10
Hydraulic Oil Filter.....	HC-5516
Hydraulic Oil Filter.....	HC-5504
Hydraulic Oil Filter.....	HC-5505
Oil Filter Full Flow.....	C-5516
771D (DUMP TRUCKS) CAT 3408E TA-HEUI (S/N: 6YS1-UP)	
Air Filter Secondary.....	A-5556
Air Filter Set.....	A-5555-S
Air Filter Primary.....	A-5555

MODEL/APPLICATION	SAKURA NO
CATERPILLAR	
771D (DUMP TRUCKS) CAT 3408E TA-HEUI (S/N: 6YS1-UP)	
Fuel Filter.....	FC-5509
Hydraulic Oil Filter.....	HC-5505
Hydraulic Oil Filter.....	HC-5504
Hydraulic Oil Filter.....	HC-55300
Hydraulic Oil Filter.....	HC-5516
Hydraulic Oil Filter.....	HC-55170
Oil Filter Full Flow.....	C-5516
771C (DUMP TRUCKS) S/N: 3BJ1-UP	
Air Filter Secondary.....	A-5556
Air Filter Primary.....	A-5555
Air Filter Set.....	A-5555-S
771C (DUMP TRUCKS) S/N: 3BJ200-UP	
Air Filter Set.....	A-5555-S
Air Filter Primary.....	A-5555
Air Filter Secondary.....	A-5556
Fuel Filter.....	F-5505
Fuel Filter.....	FC-5509
Hydraulic Oil Filter.....	H-5504
Hydraulic Oil Filter.....	H-5503
Hydraulic Oil Filter.....	H-55280
Hydraulic Oil Filter.....	H-5526
Hydraulic Oil Filter.....	H-55270
Oil Filter Full Flow.....	C-5516
771D US (DUMP TRUCKS) CAT 3408E (S/N: 6JR1-UP)	
Air Filter Secondary.....	A-5556
Air Filter Primary.....	A-5555
Air Filter Set.....	A-5555-S
Air Filter.....	AH-7001
Fuel Filter.....	FC-5509
Fuel/Water Separator Secondary..	SFC-5504-10B
Fuel/Water Separator Secondary..	SFC-5504-10
Hydraulic Oil Filter.....	H-5503
Hydraulic Oil Filter.....	H-5504
Oil Filter Full Flow.....	C-5516
772 (DUMP TRUCKS) CAT S/N: RHX1-UP	
Air Filter Primary.....	A-8665M
Air Filter Primary.....	A-8686
Air Filter Secondary.....	A-8580
Air Filter Secondary.....	A-7626
Air Filter Set.....	A-7627-S
Cabin Air Filter.....	CA-55060
Fuel Filter.....	FC-5510
Fuel Filter.....	FC-5517
Hydraulic Oil Filter.....	H-55270
Hydraulic Oil Filter.....	HC-55300
Hydraulic Oil Filter.....	HC-55170
Hydraulic Oil Filter.....	HC-5505
Hydraulic Oil Filter.....	HC-5516
Hydraulic Oil Filter.....	H-5001
Oil Filter Full Flow.....	C-7906
772 (DUMP TRUCKS) CAT S/N: RLB1-UP	

MODEL/APPLICATION	SAKURA NO
CATERPILLAR	
Air Filter Set.....	A-7627-S
Air Filter Secondary.....	A-7626
Air Filter Secondary.....	A-8580
Air Filter Primary.....	A-8686
Air Filter Primary.....	A-8665M
Cabin Air Filter.....	CA-55060
Fuel Filter.....	FC-5510
Fuel Filter.....	FC-5517
Hydraulic Oil Filter.....	HC-5516
Hydraulic Oil Filter.....	HC-5505
Hydraulic Oil Filter.....	H-5001
Hydraulic Oil Filter.....	HC-55170
Hydraulic Oil Filter.....	HC-55300
Hydraulic Oil Filter.....	H-55270
Oil Filter Full Flow.....	C-7906
772 (DUMP TRUCKS)	
Air Filter Secondary.....	A-5520
Air Filter Set.....	A-5544-S
Air Filter Primary.....	A-5543
Fuel Filter.....	FC-5501
Hydraulic Oil Filter.....	H-5503
Oil Filter Full Flow.....	O-5503
Oil Filter Full Flow.....	O-5502
772B (DUMP TRUCKS) CAT 3412	
Fuel Filter.....	FC-5519
Oil Filter Full Flow.....	C-5516
773 (DUMP TRUCKS) S/N: 63G1-252	
Air Filter Secondary.....	A-5520
Air Filter Primary.....	A-5543
Air Filter Set.....	A-5544-S
Hydraulic Oil Filter.....	H-5503
Oil Filter Full Flow.....	O-5501
773 (DUMP TRUCKS) S/N: 63G253-339	
Air Filter Set.....	A-5544-S
Air Filter Primary.....	A-5543
Air Filter Primary.....	A-5558
Air Filter Secondary.....	A-5559
Air Filter Secondary.....	A-5520
Fuel Filter Secondary.....	FC-5507
Hydraulic Oil Filter.....	H-5503
Oil Filter Full Flow.....	O-5503
773 (DUMP TRUCKS) S/N: 63G340-858	
Air Filter Secondary.....	A-5520
Air Filter Secondary.....	A-5559
Air Filter Primary.....	A-5558
Air Filter Primary.....	A-5543
Air Filter Set.....	A-5544-S
Fuel Filter Secondary.....	FC-5507
Hydraulic Oil Filter.....	H-5503
Oil Filter Full Flow.....	O-5503
773 (DUMP TRUCKS) S/N: 63G859-UP	
Air Filter Secondary.....	A-5520
Air Filter Set.....	A-5544-S

MODEL/APPLICATION	SAKURA NO
CATERPILLAR	
Air Filter Primary.....	A-5543
Air Filter Primary.....	A-5558
Air Filter Secondary.....	A-5559
Fuel Filter Secondary.....	FC-5507
Hydraulic Oil Filter.....	H-5503
Oil Filter Full Flow.....	C-5516
773B (DUMP TRUCKS) CAT 3412 (S/N: 63W1-UP) , 2005-UP	
Air Filter Set.....	A-5521-S
Air Filter Secondary.....	A-5529
Air Filter Primary.....	A-5521
Coolant Filter.....	WC-5707
Coolant Filter.....	WC-5705
Fuel Filter.....	FC-5509
Hydraulic Oil Filter.....	H-5503
Oil Filter Full Flow.....	C-5516
773B (DUMP TRUCKS) S/N: 63W1-UP	
Air Filter Set.....	A-5521-S
Air Filter Primary.....	A-5521
Air Filter Secondary.....	A-5556
Air Filter Set.....	A-5555-S
Air Filter Primary.....	A-5555
Air Filter Secondary.....	A-5529
Fuel Filter.....	FC-5519
Fuel Filter.....	FC-5509
Hydraulic Oil Filter.....	H-5503
Oil Filter Full Flow.....	C-5516
773D (DUMP TRUCKS) CAT 3412E (S/N: 7CS1-00480) , 2005-UP	
Air Filter.....	AH-7001
773D (DUMP TRUCKS) CAT 3412E (S/N: 7CS1-UP) , 2005-UP	
Air Filter Primary.....	A-5555
Air Filter Set.....	A-5555-S
Air Filter Secondary.....	A-5556
Fuel Filter.....	FC-5509
Fuel/Water Separator Secondary..	SFC-5504-10B
Fuel/Water Separator Secondary..	SFC-5504-10
Hydraulic Oil Filter.....	HC-5516
Hydraulic Oil Filter.....	HC-5505
Hydraulic Oil Filter.....	HC-5504
Oil Filter Full Flow.....	C-5516
773D (DUMP TRUCKS) CAT 3412E (S/N: 7ER1-UP) , 2005-UP	
Air Filter Secondary.....	A-5556
Air Filter Set.....	A-5555-S
Air Filter Primary.....	A-5555
Fuel Filter.....	FC-5509
Fuel/Water Separator Secondary..	SFC-5504-10B
Fuel/Water Separator Secondary..	SFC-5504-10
Hydraulic Oil Filter.....	H-5503
Oil Filter Full Flow.....	C-5516
773D (DUMP TRUCKS)	
Fuel/Water Separator Primary....	SFC-5504-30B
Fuel/Water Separator Primary....	SFC-5504-30

MODEL/APPLICATION	SAKURA NO
CATERPILLAR	
773D <i>(DUMP TRUCKS)</i> S/N: 7ER1-UP	
Air Filter Primary.....	A-5555
Air Filter Set.....	A-5555-S
Air Filter Secondary.....	A-5556
Fuel Filter.....	FC-5509
Hydraulic Oil Filter.....	H-5526
Hydraulic Oil Filter.....	H-55280
Hydraulic Oil Filter.....	H-5503
Oil Filter Full Flow.....	C-5516
773E <i>(DUMP TRUCKS)</i> CAT 3412E (S/N: BDA1-478) , 2005-UP	
Air Filter.....	AH-7001
773E <i>(DUMP TRUCKS)</i> CAT 3412E (S/N: BDA1-UP) , 2005-UP	
Air Filter Primary.....	A-5555
Air Filter Set.....	A-5555-S
Air Filter Secondary.....	A-5556
Fuel Filter.....	FC-5509
Fuel/Water Separator Secondary..	SFC-5504-10
Fuel/Water Separator Secondary..	SFC-5504-10B
Hydraulic Oil Filter.....	HC-55170
Hydraulic Oil Filter.....	HC-5504
Hydraulic Oil Filter.....	HC-5505
Hydraulic Oil Filter.....	HC-5516
Hydraulic Oil Filter.....	HC-55300
Oil Filter Full Flow.....	C-5516
773E <i>(DUMP TRUCKS)</i> CAT 3412E (S/N: BDA259-478) , 2005-UP	
Air Filter Secondary.....	A-5556
Air Filter Set.....	A-5555-S
Air Filter Primary.....	A-5555
Fuel Filter.....	FC-5509
Fuel/Water Separator Secondary..	SFC-5504-10B
Fuel/Water Separator Secondary..	SFC-5504-10
Hydraulic Oil Filter.....	HC-55170
Hydraulic Oil Filter.....	HC-55300
Hydraulic Oil Filter.....	HC-5516
Hydraulic Oil Filter.....	HC-5505
Hydraulic Oil Filter.....	HC-5504
Oil Filter Full Flow.....	C-5516
773E <i>(DUMP TRUCKS)</i> CAT S/N: 5JJ264-UP , 2005-UP	
Air Filter Primary.....	A-5555
Air Filter Set.....	A-5555-S
Air Filter Secondary.....	A-5556
Fuel Filter.....	FC-5509
Fuel/Water Separator Secondary..	SFC-5504-10
Fuel/Water Separator Secondary..	SFC-5504-10B
Hydraulic Oil Filter.....	HC-55170
Hydraulic Oil Filter.....	HC-55300
Hydraulic Oil Filter.....	HC-5516
Hydraulic Oil Filter.....	HC-5505
Hydraulic Oil Filter.....	HC-5504
Oil Filter Full Flow.....	C-5516
773E <i>(DUMP TRUCKS)</i> CAT S/N: BDA1-159-UP , 2005-UP	
Air Filter Primary.....	A-5555
Air Filter Set.....	A-5555-S
Air Filter Secondary.....	A-5556
Fuel Filter.....	FC-5509
Fuel/Water Separator Secondary..	SFC-5504-10
Fuel/Water Separator Secondary..	SFC-5504-10B
Hydraulic Oil Filter.....	HC-55170
Hydraulic Oil Filter.....	HC-5504
Hydraulic Oil Filter.....	HC-5505
Hydraulic Oil Filter.....	HC-5516
Hydraulic Oil Filter.....	HC-55300
Hydraulic Oil Filter.....	HC-55290
Oil Filter Full Flow.....	C-5516

MODEL/APPLICATION	SAKURA NO
CATERPILLAR	
Air Filter Secondary.....	A-5556
Air Filter Set.....	A-5555-S
Air Filter Primary.....	A-5555
Fuel Filter.....	FC-5509
Fuel/Water Separator Secondary..	SFC-5504-10B
Fuel/Water Separator Secondary..	SFC-5504-10
Hydraulic Oil Filter.....	HC-55290
Hydraulic Oil Filter.....	HC-55300
Hydraulic Oil Filter.....	HC-55170
Hydraulic Oil Filter.....	HC-5516
Hydraulic Oil Filter.....	HC-5505
Hydraulic Oil Filter.....	HC-5504
Oil Filter Full Flow.....	C-5516
773E <i>(DUMP TRUCKS)</i> CAT S/N: BDA160-UP , 2005-UP	
Air Filter Primary.....	A-5555
Air Filter Set.....	A-5555-S
Air Filter Secondary.....	A-5556
Fuel Filter.....	FC-5509
Fuel/Water Separator Secondary..	SFC-5504-10
Fuel/Water Separator Secondary..	SFC-5504-10B
Hydraulic Oil Filter.....	HC-55170
Hydraulic Oil Filter.....	HC-5504
Hydraulic Oil Filter.....	HC-5505
Hydraulic Oil Filter.....	HC-5516
Hydraulic Oil Filter.....	HC-55300
Hydraulic Oil Filter.....	HC-55290
Oil Filter Full Flow.....	C-5516
773E <i>(DUMP TRUCKS)</i> CAT 3412E	
Fuel/Water Separator Primary....	SFC-5504-30
Fuel/Water Separator Primary....	SFC-5504-30B
773F <i>(DUMP TRUCKS)</i> 2007-UP	
Air Filter Primary.....	A-8686
Air Filter Secondary.....	A-7626
Air Filter Set.....	A-7627-S
Fuel Filter.....	FC-5503
Hydraulic Oil Filter.....	H-5504
Hydraulic Oil Filter.....	HC-55200
773D US <i>(DUMP TRUCKS)</i> CAT 3412E (S/N: 7ER1-UP) , 2005-UP	
Air Filter Primary.....	A-5555
Air Filter Set.....	A-5555-S
Air Filter Secondary.....	A-5556
Air Filter.....	AH-7001
Fuel Filter.....	FC-5509
Fuel/Water Separator Secondary..	SFC-5504-10
Fuel/Water Separator Secondary..	SFC-5504-10B
Hydraulic Oil Filter.....	H-5503
Oil Filter Full Flow.....	C-5516
775 <i>(DUMP TRUCKS)</i>	
Fuel Filter.....	FC-5506
Hydraulic Oil Filter.....	H-5503
Hydraulic Oil Filter.....	H-5517
775B <i>(DUMP TRUCKS)</i> CAT 3412 (S/N: 7XJ200-UP) , 2005-UP	
Air Filter Secondary.....	A-5529

MODEL/APPLICATION	SAKURA NO
CATERPILLAR	
Air Filter Primary.....	A-5521
Air Filter Set.....	A-5521-S
Air Filter Secondary.....	A-5556
Air Filter Set.....	A-5555-S
Air Filter Primary.....	A-5555
Fuel Filter.....	FC-5509
Fuel Filter.....	F-5505
Hydraulic Oil Filter.....	H-5503
Oil Filter Full Flow.....	C-5516
775B <i>(DUMP TRUCKS)</i> S/N: 7XJ1-UP	
Air Filter Primary.....	A-5555
Air Filter Set.....	A-5555-S
Air Filter Secondary.....	A-5556
775B <i>(DUMP TRUCKS)</i> S/N: 7XJ200-UP	
Air Filter Secondary.....	A-5556
Air Filter Set.....	A-5555-S
Air Filter Primary.....	A-5555
Air Filter Set.....	A-5521-S
Air Filter Primary.....	A-5521
Fuel Filter.....	FC-5509
Hydraulic Oil Filter.....	H-55280
Hydraulic Oil Filter.....	H-5526
Hydraulic Oil Filter.....	H-5503
Oil Filter Full Flow.....	C-5516
775D <i>(DUMP TRUCKS)</i> CAT 3412E (S/N: 6KR1-123) , 2005-UP	
Air Filter Primary.....	A-5555
Air Filter Set.....	A-5555-S
Air Filter Secondary.....	A-5556
Fuel Filter.....	FC-5509
Fuel/Water Separator Secondary..	SFC-5504-10
Fuel/Water Separator Secondary..	SFC-5504-10B
Hydraulic Oil Filter.....	H-5503
Oil Filter Full Flow.....	C-5516
775D <i>(DUMP TRUCKS)</i> CAT 3412E (S/N: 8AS1-UP) , 2005-UP	
Air Filter Secondary.....	A-5556
Air Filter.....	AH-7001
Air Filter Set.....	A-5555-S
Air Filter Primary.....	A-5555
Fuel Filter.....	FC-5509
Fuel/Water Separator Secondary..	SFC-5504-10B
Fuel/Water Separator Secondary..	SFC-5504-10
Hydraulic Oil Filter.....	HC-5516
Hydraulic Oil Filter.....	HC-5505
Hydraulic Oil Filter.....	HC-5504
Oil Filter Full Flow.....	C-5516
775D <i>(DUMP TRUCKS)</i>	
Fuel/Water Separator Primary....	SFC-5504-30B
Fuel/Water Separator Primary....	SFC-5504-30
775D <i>(DUMP TRUCKS)</i> S/N: 6KR1-123	
Air Filter Set.....	A-5555-S
Air Filter Secondary.....	A-5556
Air Filter Primary.....	A-5555

MODEL/APPLICATION	SAKURA NO
CATERPILLAR	
775D (DUMP TRUCKS) S/N: 6KR1-123	
Fuel Filter.....	FC-5509
Hydraulic Oil Filter.....	H-5503
Hydraulic Oil Filter.....	H-5526
Hydraulic Oil Filter.....	H-55280
Oil Filter Full Flow.....	C-5516
775E (DUMP TRUCKS) CAT 3412E (S/N: BEC1-UP) , 2005-UP	
Air Filter Secondary.....	A-5556
Air Filter Set.....	A-5555-S
Air Filter Primary.....	A-5555
Air Filter.....	AH-7001
Fuel Filter.....	FC-5509
Fuel/Water Separator Secondary..	SFC-5504-10
Fuel/Water Separator Secondary..	SFC-5504-10B
Hydraulic Oil Filter.....	HC-5504
Hydraulic Oil Filter.....	HC-5505
Hydraulic Oil Filter.....	HC-5516
Oil Filter Full Flow.....	C-5516
775E (DUMP TRUCKS)	
Fuel/Water Separator Primary....	SFC-5504-30
Fuel/Water Separator Primary....	SFC-5504-30B
775F (DUMP TRUCKS) CAT S/N: DLS1-UP , 2006-UP	
Air Filter Primary.....	A-8686
Air Filter Secondary.....	A-7626
Air Filter Set.....	A-7627-S
Fuel Filter.....	FC-5510
Hydraulic Oil Filter.....	HC-55170
Hydraulic Oil Filter.....	H-5001
Hydraulic Oil Filter.....	HC-5505
Oil Filter Full Flow.....	C-5516
775F (DUMP TRUCKS) CAT S/N: LJX1-UP , 2006-UP	
Air Filter Set.....	A-7627-S
Air Filter Secondary.....	A-7626
Air Filter Primary.....	A-8686
Fuel Filter.....	FC-5510
Hydraulic Oil Filter.....	HC-5505
Hydraulic Oil Filter.....	H-5001
Hydraulic Oil Filter.....	HC-55170
Oil Filter Full Flow.....	C-5516
775B US (DUMP TRUCKS) CAT 3412 DITA (S/N: 7XJ200-UP) , 2005-UP	
Air Filter Primary.....	A-5555
Air Filter Set.....	A-5555-S
Air Filter Secondary.....	A-5556
Air Filter.....	AH-7001
Fuel Filter.....	FC-5509
Fuel/Water Separator Secondary..	SFC-5504-10B
Fuel/Water Separator Secondary..	SFC-5504-10
Hydraulic Oil Filter.....	H-5503
Oil Filter Full Flow.....	C-5516
775D US (DUMP TRUCKS) CAT 3412 DITA (S/N: 6KR124-UP) , 2005-UP	
Air Filter Secondary.....	A-5556

MODEL/APPLICATION	SAKURA NO
CATERPILLAR	
Air Filter Set.....	A-5555-S
Air Filter Primary.....	A-5555
Air Filter.....	AH-7001
Fuel Filter.....	FC-5509
Fuel/Water Separator Secondary..	SFC-5504-10
Fuel/Water Separator Secondary..	SFC-5504-10B
Hydraulic Oil Filter.....	H-5503
Oil Filter Full Flow.....	C-5516
776 (DUMP TRUCKS) CAT D348	
Air Filter.....	A-5518
Fuel Filter.....	F-5501
Oil Filter Full Flow.....	O-5503
Oil Filter Full Flow.....	O-5501
776 (DUMP TRUCKS) S/N: 14H1-UP	
Air Filter Secondary.....	A-5502
Air Filter Primary.....	A-5501
Fuel Filter.....	F-5501
Hydraulic Oil Filter.....	H-5503
776 (DUMP TRUCKS) w/D348 Eng.	
Hydraulic Oil Filter.....	H-55320
776B (DUMP TRUCKS) S/N: 6JC1-UP	
Air Filter Set.....	A-5544-S
Air Filter Primary.....	A-5558
Air Filter Primary.....	A-5543
Air Filter Secondary.....	A-7915
Fuel Filter.....	FC-5506
Hydraulic Oil Filter.....	H-5503
Oil Filter Full Flow.....	O-5502
Oil Filter Full Flow.....	C-5516
776D (DUMP TRUCKS) CAT (S/N: 2GR1-2632-UP)	
Air Filter Primary.....	A-44220
Air Filter Secondary.....	A-44230
Air Filter Set.....	A-44240-S
Air Filter Secondary.....	A-5715
Air Filter Primary.....	A-5593
Air Filter Set.....	A-5595-S
Air Filter Secondary.....	A-5594
Fuel Filter.....	FC-5510
776D (DUMP TRUCKS) CAT (S/N: 2GR2633-UP)	
Air Filter Secondary.....	A-5594
Air Filter Set.....	A-5595-S
Air Filter Primary.....	A-5593
Air Filter Secondary.....	A-5715
Air Filter Set.....	A-44240-S
Air Filter Secondary.....	A-44230
Air Filter Primary.....	A-44220
Fuel Filter.....	FC-5510
776D (DUMP TRUCKS)	
Air Filter Set.....	A-5595-S
Air Filter Secondary.....	A-5594
Air Filter Primary.....	A-5593

MODEL/APPLICATION	SAKURA NO
CATERPILLAR	
Hydraulic Oil Filter.....	H-5504
776D (DUMP TRUCKS) S/N: 5ER1-122-UP	
Air Filter Primary.....	A-5593
Air Filter Set.....	A-5595-S
Hydraulic Oil Filter.....	H-5526
Hydraulic Oil Filter.....	H-55270
Hydraulic Oil Filter.....	H-55280
Hydraulic Oil Filter.....	H-5503
776D (DUMP TRUCKS) S/N: 5ER123-UP	
Air Filter Primary.....	A-5593
Air Filter Set.....	A-5595-S
Hydraulic Oil Filter.....	H-5503
Hydraulic Oil Filter.....	H-55280
Hydraulic Oil Filter.....	H-55270
Hydraulic Oil Filter.....	H-5526
776D (DUMP TRUCKS) S/N: AFS1-80-UP	
Air Filter Primary.....	A-5593
Air Filter Set.....	A-5595-S
Fuel Filter Secondary.....	FC-5507
Hydraulic Oil Filter.....	H-5526
Hydraulic Oil Filter.....	H-55270
Hydraulic Oil Filter.....	HC-55170
Hydraulic Oil Filter.....	HC-55290
Hydraulic Oil Filter.....	HC-5505
Hydraulic Oil Filter.....	H-55280
Hydraulic Oil Filter.....	H-5503
776D (DUMP TRUCKS) S/N: AFS81-UP	
Air Filter Primary.....	A-5593
Air Filter Set.....	A-5595-S
Fuel Filter Secondary.....	FC-5507
Hydraulic Oil Filter.....	HC-5505
Hydraulic Oil Filter.....	HC-55290
Hydraulic Oil Filter.....	HC-55170
Hydraulic Oil Filter.....	H-55270
Hydraulic Oil Filter.....	H-5526
Hydraulic Oil Filter.....	H-5503
Hydraulic Oil Filter.....	H-55280
776C (DUMP TRUCKS) CAT S/N: 2TK1-UP	
Air Filter Secondary.....	A-5594
Air Filter Set.....	A-5595-S
Air Filter Primary.....	A-5593
Air Filter Secondary.....	A-7915
Fuel Filter.....	FC-5510
Fuel Filter.....	FC-5506
Hydraulic Oil Filter.....	H-55270
Hydraulic Oil Filter.....	H-5503
776C (DUMP TRUCKS) CAT S/N: 7YG1-211-UP	
Air Filter Secondary.....	A-5594
Air Filter Secondary.....	A-7915
Air Filter Primary.....	A-5593
Air Filter Set.....	A-5595-S
Fuel Filter.....	FC-5510
Fuel Filter.....	FC-5506

MODEL/APPLICATION	SAKURA NO
CATERPILLAR	
776C (DUMP TRUCKS) CAT S/N: 7YG1-211-UP	
Hydraulic Oil Filter.....	H-5503
Hydraulic Oil Filter.....	H-55270
776C (DUMP TRUCKS) CAT S/N: 7YG212-UP	
Air Filter Set.....	A-5595-S
Air Filter Primary.....	A-5593
Air Filter Secondary.....	A-7915
Air Filter Secondary.....	A-5594
Fuel Filter.....	FC-5510
Fuel Filter.....	FC-5506
Hydraulic Oil Filter.....	H-55270
Hydraulic Oil Filter.....	H-5503
776D US (DUMP TRUCKS) CAT 3508B (S/N: 5ER1-UP)	
Air Filter.....	AH-7001
Air Filter Primary.....	A-5593
Air Filter Set.....	A-5595-S
Air Filter Secondary.....	A-5594
Fuel Filter.....	F-5505
Fuel Filter.....	FC-5510
Hydraulic Oil Filter.....	H-5503
Hydraulic Oil Filter.....	H-5504
777 (DUMP TRUCKS) CAT (S/N: 2GR1-2632-UP)	
Air Filter Set.....	A-44240-S
Air Filter Secondary.....	A-44230
Air Filter Primary.....	A-44220
Air Filter Secondary.....	A-5594
Air Filter Set.....	A-5595-S
Air Filter Primary.....	A-5593
Air Filter Secondary.....	A-5715
Fuel Filter.....	FC-5510
777 (DUMP TRUCKS) S/N: 84A1-559-UP	
Hydraulic Oil Filter.....	H-5503
Hydraulic Oil Filter.....	H-55270
777 (DUMP TRUCKS) S/N: 84A1-UP	
Air Filter Set.....	A-5573-S
Air Filter Primary.....	A-5501
Air Filter Secondary.....	A-5502
Air Filter Secondary.....	A-5534
Air Filter Primary.....	A-5535
Fuel Filter.....	F-5501
Hydraulic Oil Filter.....	H-5503
Oil Filter Full Flow.....	C-5516
777A (DUMP TRUCKS) CAT D348	
Air Filter Secondary.....	A-5502
Fuel Filter.....	F-5501
Hydraulic Oil Filter.....	H-5503
777B (DUMP TRUCKS) CAT 3508 (S/N: 4YC1-UP) , 2005-UP	
Fuel Filter.....	FC-5510
Hydraulic Oil Filter.....	H-5503

MODEL/APPLICATION	SAKURA NO
CATERPILLAR	
Hydraulic Oil Filter.....	H-5504
777B (DUMP TRUCKS) S/N: 3NF1-UP	
Air Filter Set.....	A-5595-S
Air Filter Secondary.....	A-5594
Air Filter Primary.....	A-5593
777B (DUMP TRUCKS) S/N: 4YC1-UP	
Air Filter Primary.....	A-5593
Air Filter Secondary.....	A-7915
Air Filter Secondary.....	A-5594
Air Filter Set.....	A-5595-S
Fuel Filter.....	FC-5506
Fuel Filter.....	FC-5510
Hydraulic Oil Filter.....	H-5503
Oil Filter Full Flow.....	C-5516
777C (DUMP TRUCKS) S/N: 4XJ1-UP	
Air Filter Secondary.....	A-5594
Air Filter Set.....	A-5595-S
Air Filter Primary.....	A-5593
Fuel Filter.....	FC-5510
Hydraulic Oil Filter.....	H-5503
777D (DUMP TRUCKS) CAT 3512B (S/N: 3PR1-UP) , 2005-UP	
Air Filter Primary.....	A-5593
Air Filter Set.....	A-5595-S
Air Filter Secondary.....	A-5594
Fuel Filter.....	F-5505
Fuel Filter.....	FC-5510
Hydraulic Oil Filter.....	H-5504
Hydraulic Oil Filter.....	H-5503
777D (DUMP TRUCKS) CAT 3512B (S/N: AGC1-UP) , 2005-UP	
Air Filter Secondary.....	A-5594
Air Filter Set.....	A-5595-S
Air Filter Primary.....	A-5593
Air Filter.....	AH-7001
Fuel Filter.....	FC-5510
Fuel Filter.....	F-5505
Hydraulic Oil Filter.....	H-55270
Hydraulic Oil Filter.....	HC-5505
Hydraulic Oil Filter.....	H-5503
Hydraulic Oil Filter.....	H-5504
777D (DUMP TRUCKS) CAT 3512B (S/N: AGY1-UP) , 2005-UP	
Air Filter Secondary.....	A-5715
Fuel Filter.....	FC-5510
Fuel Filter.....	F-5505
Hydraulic Oil Filter.....	H-5504
Hydraulic Oil Filter.....	H-5503
Hydraulic Oil Filter.....	HC-5505
777D (DUMP TRUCKS) CAT 3508B EUI (S/N: 3PR1-UP)	
Air Filter Primary.....	A-5593
Air Filter Set.....	A-5595-S
Air Filter Secondary.....	A-5594
Fuel Filter.....	FC-5510

MODEL/APPLICATION	SAKURA NO
CATERPILLAR	
Hydraulic Oil Filter.....	H-5503
Hydraulic Oil Filter.....	H-5504
Hydraulic Oil Filter.....	H-55270
Hydraulic Oil Filter.....	H-5526
Hydraulic Oil Filter.....	H-55280
777D (DUMP TRUCKS) CAT 3508B EUI (S/N: AGC1-UP)	
Air Filter Secondary.....	A-5594
Air Filter Set.....	A-5595-S
Air Filter Primary.....	A-5593
Fuel Filter.....	FC-5510
Hydraulic Oil Filter.....	H-55280
Hydraulic Oil Filter.....	HC-55170
Hydraulic Oil Filter.....	H-5526
Hydraulic Oil Filter.....	H-55270
Hydraulic Oil Filter.....	HC-5505
Hydraulic Oil Filter.....	H-5504
Hydraulic Oil Filter.....	H-5503
777D (DUMP TRUCKS) CAT 3508B EUI (S/N: AGY1-UP)	
Air Filter Secondary.....	A-5715
Fuel Filter.....	FC-5510
Hydraulic Oil Filter.....	H-5503
Hydraulic Oil Filter.....	H-5504
Hydraulic Oil Filter.....	HC-5505
Hydraulic Oil Filter.....	H-55270
Hydraulic Oil Filter.....	H-5526
Hydraulic Oil Filter.....	HC-55170
Hydraulic Oil Filter.....	H-55280
777D HAA (DUMP TRUCKS) S/N: 2YW1-UP	
Air Filter Secondary.....	A-5715
Fuel Filter.....	FC-5510
Hydraulic Oil Filter.....	H-55280
Hydraulic Oil Filter.....	H-5526
Hydraulic Oil Filter.....	H-55270
Hydraulic Oil Filter.....	H-5504
Hydraulic Oil Filter.....	H-5503
777F (DUMP TRUCKS) CAT S/N: JRP1-UP , 2007-UP	
Air Filter Set.....	A-7627-S
Air Filter Primary.....	A-8686
Air Filter Secondary.....	A-7626
Fuel Filter.....	FC-5510
Hydraulic Oil Filter.....	H-5001
Hydraulic Oil Filter.....	H-5503
Hydraulic Oil Filter.....	H-5526
Hydraulic Oil Filter.....	H-55280
Hydraulic Oil Filter.....	HC-5505
Hydraulic Oil Filter.....	HC-55170
Oil Filter Full Flow.....	C-5516
777F (DUMP TRUCKS) CAT S/N: LJW2110-UP , 2007-UP	
Air Filter Secondary.....	A-7626
Air Filter Primary.....	A-8686
Air Filter Set.....	A-7627-S
Fuel Filter.....	FC-5510
Hydraulic Oil Filter.....	HC-55170
Hydraulic Oil Filter.....	HC-5505

MODEL/APPLICATION	SAKURA NO
CATERPILLAR	
777F (DUMP TRUCKS) CAT S/N: L3W2110-UP , 2007-UP	
Hydraulic Oil Filter.....	H-55280
Hydraulic Oil Filter.....	H-5526
Hydraulic Oil Filter.....	H-5503
Hydraulic Oil Filter.....	H-5001
Oil Filter Full Flow.....	C-5516
777F (DUMP TRUCKS) CAT C32	
Hydraulic Oil Filter Transmission..	EH-55010
777D US (DUMP TRUCKS) CAT 3508B (S/N: 3PR1-UP) , 2005-UP	
Air Filter.....	AH-7001
Air Filter Secondary.....	A-5594
Air Filter Set.....	A-5595-S
Air Filter Primary.....	A-5593
Fuel Filter.....	F-5505
Fuel Filter.....	FC-5510
Hydraulic Oil Filter.....	H-5503
Hydraulic Oil Filter.....	H-5504
779 (DUMP TRUCKS)	
Air Filter Secondary.....	A-5526
Air Filter Set.....	A-5557-S
Air Filter Primary.....	A-5557
Hydraulic Oil Filter.....	H-5503
783B (DUMP TRUCKS) CAT 3512 (S/N: 5YM-UP)	
Air Filter Secondary.....	A-5715
Fuel Filter.....	FC-5506
Hydraulic Oil Filter.....	H-5503
Hydraulic Oil Filter.....	H-5504
Hydraulic Oil Filter.....	H-55270
784B (DUMP TRUCKS) S/N: 1HW-UP	
Air Filter Secondary.....	A-5715
Air Filter.....	A-5547
Fuel Filter.....	FC-5510
Fuel Filter.....	FC-5506
Hydraulic Oil Filter.....	H-5504
Hydraulic Oil Filter.....	H-55270
Hydraulic Oil Filter.....	H-5503
784B (DUMP TRUCKS) S/N: 6HK-UP	
Air Filter Secondary.....	A-5715
Air Filter.....	A-5547
Fuel Filter.....	FC-5510
Fuel Filter.....	FC-5506
Hydraulic Oil Filter.....	H-5504
Hydraulic Oil Filter.....	H-5503
Hydraulic Oil Filter.....	H-55270

MODEL/APPLICATION	SAKURA NO
CATERPILLAR	
784B (DUMP TRUCKS) S/N: 8GB-UP	
Air Filter Secondary.....	A-5715
Air Filter.....	A-5547
Fuel Filter.....	FC-5506
Fuel Filter.....	FC-5510
Hydraulic Oil Filter.....	H-5504
Hydraulic Oil Filter.....	H-55270
Hydraulic Oil Filter.....	H-5503
784C (DUMP TRUCKS) S/N: 2PZ1-UP	
Air Filter Secondary.....	A-5715
Fuel Filter.....	FC-5510
Fuel/Water Separator.....	SF-1907
Hydraulic Oil Filter.....	H-5503
Hydraulic Oil Filter.....	H-5504
Hydraulic Oil Filter.....	H-55270
Hydraulic Oil Filter.....	H-5526
Hydraulic Oil Filter.....	H-55280
785 (DUMP TRUCKS) CAT 3512 (S/N: 8GB1-UP)	
Air Filter.....	A-5547
Air Filter Secondary.....	A-5715
Air Filter.....	AH-7001
Fuel Filter.....	FC-5510
Hydraulic Oil Filter.....	H-55270
Hydraulic Oil Filter.....	H-5504
Hydraulic Oil Filter.....	H-5503
785B (DUMP TRUCKS) CAT 3512 (S/N: 6HK1-UP)	
Air Filter.....	AH-7001
Air Filter Secondary.....	A-5715
Air Filter.....	A-5547
Fuel Filter.....	F-5505
Fuel Filter.....	FC-5510
Hydraulic Oil Filter.....	H-5503
Hydraulic Oil Filter.....	H-5504
Hydraulic Oil Filter.....	H-55270
785B (DUMP TRUCKS) CAT 3512 TA-EUI (S/N: 6HK433-UP)	
Air Filter Secondary.....	A-5715
Fuel Filter.....	FC-5510
Hydraulic Oil Filter.....	H-5526
Hydraulic Oil Filter.....	H-55280
Hydraulic Oil Filter.....	H-55270
Hydraulic Oil Filter.....	H-5504
Hydraulic Oil Filter.....	H-5503
785B (DUMP TRUCKS) S/N: 1HW-UP	
Air Filter.....	A-5547
Air Filter Secondary.....	A-5715
Fuel Filter.....	FC-5510
Fuel Filter.....	FC-5506
Hydraulic Oil Filter.....	H-55270
Hydraulic Oil Filter.....	H-5503
785B (DUMP TRUCKS) S/N: 6HK00123-6HK00129	
Air Filter.....	A-5547
Air Filter Secondary.....	A-5715
Fuel Filter.....	FC-5510
Fuel Filter.....	FC-5506
Hydraulic Oil Filter.....	H-55270
Hydraulic Oil Filter.....	H-5503
Hydraulic Oil Filter.....	H-5504

MODEL/APPLICATION	SAKURA NO
CATERPILLAR	
Air Filter Secondary.....	A-5715
Fuel Filter.....	FC-5506
Hydraulic Oil Filter.....	H-5504
Hydraulic Oil Filter.....	H-5503
Hydraulic Oil Filter.....	H-55270
Oil Filter Full Flow.....	C-5516
785B (DUMP TRUCKS) S/N: 6HK00216-6HK00216	
Air Filter Secondary.....	A-5715
Fuel Filter.....	FC-5506
Hydraulic Oil Filter.....	H-55270
Hydraulic Oil Filter.....	H-5503
Hydraulic Oil Filter.....	H-5504
Oil Filter Full Flow.....	C-5516
785B (DUMP TRUCKS) S/N: 6HK-UP	
Air Filter Secondary.....	A-5715
Air Filter.....	A-5547
Fuel Filter.....	FC-5506
Fuel Filter.....	FC-5510
Hydraulic Oil Filter.....	H-5504
Hydraulic Oil Filter.....	H-5503
Hydraulic Oil Filter.....	H-55270
785B (DUMP TRUCKS) S/N: 8GB-UP	
Air Filter Secondary.....	A-5715
Air Filter.....	A-5547
Fuel Filter.....	FC-5510
Fuel Filter.....	FC-5506
Hydraulic Oil Filter.....	H-55270
Hydraulic Oil Filter.....	H-5503
Hydraulic Oil Filter.....	H-5504
785C (DUMP TRUCKS) CAT 3516B (S/N: 1HW1-UP) , 2005-UP	
Air Filter Secondary.....	A-5715
Air Filter Secondary.....	A-9205
Air Filter.....	AH-7001
Cabin Air Filter.....	CA-55060
Fuel Filter.....	FC-5510
Fuel Filter Secondary.....	FC-5507
Fuel Filter.....	F-5505
Fuel/Water Separator.....	SF-1907
Hydraulic Oil Filter.....	H-5504
Hydraulic Oil Filter.....	H-5503
Hydraulic Oil Filter.....	H-5526
785C (DUMP TRUCKS) CAT 3516B (S/N: 5AZ1-UP) , 2005-UP	
Air Filter.....	AH-7001
Air Filter Secondary.....	A-9205
Cabin Air Filter.....	CA-55060
Fuel Filter.....	F-5505
Fuel Filter.....	FC-5510
Hydraulic Oil Filter.....	H-5503
Hydraulic Oil Filter.....	H-5504
785C (DUMP TRUCKS) CAT 3516B (S/N: APX1-UP) , 2005-UP	
Air Filter Secondary.....	A-5715
Fuel Filter.....	F-5505
Fuel Filter.....	FC-5510

MODEL/APPLICATION	SAKURA NO
CATERPILLAR	
785C (DUMP TRUCKS) CAT 3516B (S/N: APX1-UP) , 2005-UP	
Hydraulic Oil Filter.....	H-5504
Hydraulic Oil Filter.....	H-5503
785C (DUMP TRUCKS) CAT 3512	
Fuel/Water Separator.....	SFC-55280
Fuel/Water Separator.....	SFC-55281
785C (DUMP TRUCKS) CAT 3512 TA-EUI (S/N: 1HW1-UP)	
Air Filter Secondary.....	A-5715
Fuel Filter.....	FC-5510
Hydraulic Oil Filter.....	H-55280
Hydraulic Oil Filter.....	H-55270
Hydraulic Oil Filter.....	H-5504
Hydraulic Oil Filter.....	H-5503
785C (DUMP TRUCKS) CAT 3512 TA-EUI (S/N: 5AZ1-UP)	
Air Filter Secondary.....	A-9205
Fuel Filter.....	FC-5510
Hydraulic Oil Filter.....	H-5503
Hydraulic Oil Filter.....	H-5504
Hydraulic Oil Filter.....	H-55270
Hydraulic Oil Filter.....	H-55280
Hydraulic Oil Filter.....	H-5526
785D (DUMP TRUCKS) CAT 3512	
Fuel/Water Separator.....	SFC-55281
Fuel/Water Separator.....	SFC-55280
786 (DUMP TRUCKS) S/N: 81A1-UP	
Oil Filter Full Flow.....	O-5503
787B (DUMP TRUCKS) CAT S/N: 2PK450-UP	
Air Filter.....	A-5547
Air Filter Secondary.....	A-9205
Fuel Filter.....	FC-5510
Hydraulic Oil Filter.....	H-5503
Hydraulic Oil Filter.....	H-5506
Hydraulic Oil Filter.....	H-55270
Hydraulic Oil Filter.....	H-5526
Hydraulic Oil Filter.....	H-55280
Hydraulic Oil Filter.....	H-5503
787B (DUMP TRUCKS) CAT S/N: 9TM1-UP	
Air Filter Secondary.....	A-9205
Air Filter.....	A-5547
Fuel Filter.....	FC-5510
Hydraulic Oil Filter.....	H-55280
Hydraulic Oil Filter.....	H-5526
Hydraulic Oil Filter.....	H-55270
Hydraulic Oil Filter.....	H-5506
Hydraulic Oil Filter.....	H-5503
789 (DUMP TRUCKS) CAT 3516 (S/N: 2BW-UP)	
Air Filter Secondary.....	A-9205
Fuel Filter.....	FC-5510
Fuel Filter Secondary.....	FC-5507
Fuel Filter.....	F-5505
Fuel1/Water Separator.....	SF-1907
Hydraulic Oil Filter.....	H-5506
Hydraulic Oil Filter.....	H-5503
Hydraulic Oil Filter.....	H-5504

MODEL/APPLICATION	SAKURA NO
CATERPILLAR	
Fuel Filter.....	FC-5506
Hydraulic Oil Filter.....	H-5506
Hydraulic Oil Filter.....	H-5503
Hydraulic Oil Filter.....	H-5504
789 (DUMP TRUCKS) CAT 3516 (S/N: 7EK-UP)	
Air Filter Secondary.....	A-9205
Fuel Filter.....	FC-5506
Fuel Filter Secondary.....	FC-5507
Fuel Filter.....	FC-5510
Hydraulic Oil Filter.....	H-5503
Hydraulic Oil Filter.....	H-5506
Hydraulic Oil Filter.....	H-5504
789 (DUMP TRUCKS) CAT 3516 (S/N: 9ZC1-UP)	
Air Filter Secondary.....	A-9205
Air Filter.....	A-5547
Air Filter.....	AH-7001
Coolant Filter.....	WC-5707
Fuel Filter.....	F-5505
Fuel Filter.....	FC-5510
Hydraulic Oil Filter.....	H-5504
Hydraulic Oil Filter.....	H-55270
Hydraulic Oil Filter.....	H-5506
Hydraulic Oil Filter.....	H-5503
789 (DUMP TRUCKS) CAT 3516 (S/N: 9ZC-UP)	
Air Filter Secondary.....	A-9205
Fuel Filter.....	FC-5506
Fuel Filter Secondary.....	FC-5507
Fuel Filter.....	FC-5510
Hydraulic Oil Filter.....	H-5504
Hydraulic Oil Filter.....	H-5503
Hydraulic Oil Filter.....	H-5506
Hydraulic Oil Filter.....	H-5503
789B (DUMP TRUCKS) CAT 3516 (S/N: 7EK1-UP)	
Air Filter.....	A-5547
Air Filter.....	AH-7001
Air Filter Secondary.....	A-9205
Coolant Filter.....	WC-5707
Fuel Filter.....	F-5505
Fuel Filter.....	FC-5510
Hydraulic Oil Filter.....	H-5504
Hydraulic Oil Filter.....	H-5503
Hydraulic Oil Filter.....	H-5506
Hydraulic Oil Filter.....	H-55270
789C (DUMP TRUCKS) CAT 3516 (S/N: 2BW1-UP) , 2005-UP	
Air Filter Secondary.....	A-9205
Air Filter.....	AH-7001
Cabin Air Filter.....	CA-55060
Fuel Filter.....	FC-5510
Fuel Filter Secondary.....	FC-5507
Fuel Filter.....	F-5505
Fuel1/Water Separator.....	SF-1907
Hydraulic Oil Filter.....	H-5506
Hydraulic Oil Filter.....	H-5503
Hydraulic Oil Filter.....	H-5504

MODEL/APPLICATION	SAKURA NO
CATERPILLAR	
789C (DUMP TRUCKS) CAT 3516 (S/N: 2BW1-UP)	
Fuel/Water Separator.....	SFC-55280
Fuel/Water Separator.....	SFC-55281
789C (DUMP TRUCKS) CAT 3516TA EUI (S/N: 2BW1-UP)	
Air Filter Secondary.....	A-9205
Fuel Filter.....	FC-5510
Hydraulic Oil Filter.....	H-5504
Hydraulic Oil Filter.....	H-5503
Hydraulic Oil Filter.....	H-55270
Hydraulic Oil Filter.....	H-5526
Hydraulic Oil Filter.....	H-55280
Hydraulic Oil Filter.....	H-5506
793 (DUMP TRUCKS) CAT 3516 (S/N: 3S31-UP)	
Air Filter.....	A-5547
Air Filter.....	AH-7001
Air Filter Secondary.....	A-7902
Fuel Filter.....	F-5505
Fuel Filter.....	FC-5510
Hydraulic Oil Filter.....	H-5504
Hydraulic Oil Filter.....	H-5503
Hydraulic Oil Filter.....	H-5506
Hydraulic Oil Filter.....	H-55280
793 (DUMP TRUCKS) S/N: 3S36-UP	
Air Filter Secondary.....	A-7902
Fuel Filter.....	FC-5506
Fuel Filter.....	FC-5510
Hydraulic Oil Filter.....	H-5506
Hydraulic Oil Filter.....	H-5504
Oil Filter Full Flow.....	C-5516
793B (DUMP TRUCKS) CAT 3516 (S/N: 1HL1-UP)	
Air Filter.....	A-5547
Air Filter.....	AH-7001
Air Filter Secondary.....	A-7902
Fuel Filter.....	F-5505
Fuel Filter.....	FC-5510
Hydraulic Oil Filter.....	H-55280
Hydraulic Oil Filter.....	H-5506
Hydraulic Oil Filter.....	H-5503
Hydraulic Oil Filter.....	H-5504
Hydraulic Oil Filter.....	HC-5506
Hydraulic Oil Filter.....	HC-5503
793B (DUMP TRUCKS) CAT 3516 (S/N: 2HL-UP)	
Air Filter Secondary.....	A-7902
Air Filter.....	A-5547
Hydraulic Oil Filter.....	H-5503
Hydraulic Oil Filter.....	H-5504
793C (DUMP TRUCKS) CAT 3516 (S/N: 4AR1-UP) , 2005-UP	
Air Filter Secondary.....	A-7902
Fuel Filter.....	F-5505
Fuel Filter.....	FC-5510
Hydraulic Oil Filter.....	H-5504

MODEL/APPLICATION	SAKURA NO	MODEL/APPLICATION	SAKURA NO	MODEL/APPLICATION	SAKURA NO
CATERPILLAR		CATERPILLAR		CATERPILLAR	
793C (DUMP TRUCKS) CAT 3516 (S/N: 4AR1-UP) , 2005-UP Hydraulic Oil Filter..... H-5503 Hydraulic Oil Filter..... H-5506 Hydraulic Oil Filter..... H-5526 Hydraulic Oil Filter..... HC-5503 Hydraulic Oil Filter..... HC-5506		Hydraulic Oil Filter..... HC-5506 Hydraulic Oil Filter..... H-5506 Hydraulic Oil Filter..... H-5504 793D (DUMP TRUCKS) CAT S/N: 7TR1-UP Air Filter Secondary..... A-7902 Cabin Air Filter..... CA-55060 Fuel Filter..... FC-5510 Fuel Filter Secondary..... FC-5507 Hydraulic Oil Filter..... H-55270 Hydraulic Oil Filter..... H-5526 Hydraulic Oil Filter..... H-55280 Hydraulic Oil Filter..... H-5503		Air Filter Secondary..... A-6007 Air Filter Set..... A-6118-S Air Filter Primary..... A-6006 Fuel Filter..... F-5505 Fuel Filter..... FC-5516 Fuel Filter Secondary..... FC-5515 Fuel Filter Secondary..... FC-55151 Fuel Filter..... FC-5508 Hydraulic Oil Filter..... H-5505 Hydraulic Oil Filter..... HC-5505 Oil Filter Full Flow..... C-5510	
793C (DUMP TRUCKS) CAT 3516 (S/N: 4GZ1-UP) , 2005-UP Air Filter Secondary..... A-7902 Fuel Filter..... FC-5510 Fuel Filter..... F-5505 Hydraulic Oil Filter..... HC-5506 Hydraulic Oil Filter..... HC-5503 Hydraulic Oil Filter..... H-5526 Hydraulic Oil Filter..... H-5506 Hydraulic Oil Filter..... H-5503 Hydraulic Oil Filter..... H-5504		793D (DUMP TRUCKS) CAT S/N: 8WM1-UP Air Filter Secondary..... A-7902 Cabin Air Filter..... CA-55060 Fuel Filter Secondary..... FC-5507 Fuel Filter..... FC-5510 Hydraulic Oil Filter..... H-5503 Hydraulic Oil Filter..... H-55280 Hydraulic Oil Filter..... H-5526 Hydraulic Oil Filter..... H-55270		814 (COMPACTORS) S/N: 14R1-UP Air Filter Secondary..... A-5510 Air Filter Set..... A-5522-S Air Filter Primary..... A-5549M Air Filter Primary..... A-5549 Air Filter Primary..... A-5509 Air Filter Secondary..... A-5550 Air Filter Set..... A-5549M-S Fuel Filter Secondary..... FC-5507 Fuel Filter..... FC-5510 Hydraulic Oil Filter..... H-5503 Hydraulic Oil Filter..... H-5504 Oil Filter Full Flow..... C-5510	
793C (DUMP TRUCKS) CAT 3516 (S/N: ATY1-UP) , 2005-UP Air Filter Secondary..... A-7902 Fuel Filter..... F-5505 Fuel Filter..... FC-5510 Fuel/Water Separator..... SF-1907 Hydraulic Oil Filter..... H-55270 Hydraulic Oil Filter..... HC-5506 Hydraulic Oil Filter..... H-5504 Hydraulic Oil Filter..... H-5503 Hydraulic Oil Filter..... H-5506		793D (DUMP TRUCKS) CAT S/N: FDB1-UP Air Filter Secondary..... A-7902 Cabin Air Filter..... CA-55060 Fuel Filter..... FC-5510 Fuel Filter Secondary..... FC-5507 Hydraulic Oil Filter..... H-55270 Hydraulic Oil Filter..... H-5526 Hydraulic Oil Filter..... H-55280 Hydraulic Oil Filter..... H-5503		814 (COMPACTORS) S/N: 90P1-156 Air Filter Secondary..... A-5520 Air Filter Set..... A-5544-S Air Filter Primary..... A-5558 Air Filter Primary..... A-5543 Air Filter Secondary..... A-5559 Fuel Filter Secondary..... FC-5507 Hydraulic Oil Filter..... H-5504 Hydraulic Oil Filter..... H-5503 Oil Filter Full Flow..... O-5502	
793C (DUMP TRUCKS) CAT 3516B EUI (S/N: 4AR1-UP) Air Filter Secondary..... A-7902 Fuel Filter..... FC-5510 Hydraulic Oil Filter..... H-5506 Hydraulic Oil Filter..... H-5503 Hydraulic Oil Filter..... H-5504 Hydraulic Oil Filter..... HC-5512 Hydraulic Oil Filter..... H-5526 Hydraulic Oil Filter..... H-55280 Hydraulic Oil Filter..... H-55270 Hydraulic Oil Filter..... HC-5506		797 (DUMP TRUCKS) CAT 3524B (S/N: 5YW1-UP) , 2005-UP Air Filter Secondary..... A-7902 Air Filter Secondary..... A-9205 Cabin Air Filter..... CA-55060 Fuel Filter..... FC-5510 Hydraulic Oil Filter..... H-5001 Hydraulic Oil Filter..... H-5503 Hydraulic Oil Filter..... H-5504		814 (COMPACTORS) S/N: 90P157-UP Air Filter Primary..... A-5549M Air Filter Set..... A-5522-S Air Filter Secondary..... A-5510 Air Filter Primary..... A-5549 Air Filter Primary..... A-5509 Air Filter Set..... A-5549M-S Air Filter Secondary..... A-5550 Fuel Filter Secondary..... FC-5507 Fuel Filter..... FC-5510 Hydraulic Oil Filter..... H-5503 Hydraulic Oil Filter..... H-5504 Oil Filter Full Flow..... C-5510	
793C (DUMP TRUCKS) CAT 3516B EUI (S/N: 4GZ1-UP) Air Filter Secondary..... A-7902 Fuel Filter..... FC-5510 Hydraulic Oil Filter..... H-5504 Hydraulic Oil Filter..... H-5503 Hydraulic Oil Filter..... H-5506 Hydraulic Oil Filter..... HC-5506 Hydraulic Oil Filter..... H-55270 Hydraulic Oil Filter..... H-55280 Hydraulic Oil Filter..... H-5526 Hydraulic Oil Filter..... HC-5512		797 (DUMP TRUCKS) CAT 3524B EUI (S/N: JSM1-UP) , 2004-UP Fuel Filter..... FC-5510 Hydraulic Oil Filter..... H-5503 Hydraulic Oil Filter..... H-5001		814B (DOZERS) 08Z3945-25424 Oil Filter Full Flow..... C-5506	
793C (DUMP TRUCKS) CAT 3516B EUI (S/N: ATY1-UP) Air Filter Secondary..... A-7902 Fuel Filter..... FC-5510 Hydraulic Oil Filter..... HC-5512 Hydraulic Oil Filter..... H-55270		797B (DUMP TRUCKS) CAT 3524B EUI (S/N: JSM1-UP) , 2004-UP Fuel Filter..... FC-5510 Hydraulic Oil Filter..... H-5503 Hydraulic Oil Filter..... H-5001		814B (DOZERS) CAT (S/N: 08Z25425-26313) Fuel Filter..... FC-5501 Oil Filter Full Flow..... C-5510	
793C (DUMP TRUCKS) CAT 3516B EUI (S/N: ATY1-UP) Air Filter Secondary..... A-7902 Fuel Filter..... FC-5510 Hydraulic Oil Filter..... HC-5512 Hydraulic Oil Filter..... H-55270		7WK (EXCAVATORS)			

MODEL/APPLICATION	SAKURA NO
CATERPILLAR	
814B (DOZERS) CAT (S/N: 08Z26314-UP)	
Fuel Filter Secondary.....	FC-5507
Oil Filter Full Flow.....	C-5510
814B (DOZERS) CAT (S/N: 08Z3945-25424)	
Fuel Filter.....	FC-5501
Oil Filter Full Flow.....	C-5510
Oil Filter Full Flow.....	C-5522
814B (DOZERS) S/N: 16Z1-274	
Air Filter Primary.....	A-5509
Air Filter Set.....	A-5522-S
Air Filter Secondary.....	A-5522
Air Filter.....	A-5546
Hydraulic Oil Filter.....	H-5506
Hydraulic Oil Filter.....	H-55270
814B (DOZERS) S/N: 16Z1-UP	
Air Filter.....	A-5546
Air Filter Primary.....	A-5549M
Air Filter Set.....	A-5549M-S
Air Filter Secondary.....	A-5522
Air Filter Primary.....	A-5549
Air Filter Set.....	A-5522-S
Air Filter Primary.....	A-5509
Air Filter Secondary.....	A-5550
Fuel Filter.....	F-5505
Fuel Filter Secondary.....	FC-5507
Hydraulic Oil Filter.....	H-5506
Hydraulic Oil Filter.....	H-5504
Oil Filter Full Flow.....	C-5510
814B (DOZERS) S/N: 16Z275-306	
Air Filter Primary.....	A-5509
Air Filter Set.....	A-5522-S
Air Filter Secondary.....	A-5550
Air Filter Primary.....	A-5549
Air Filter Secondary.....	A-5522
Air Filter Set.....	A-5549M-S
Air Filter Primary.....	A-5549M
Air Filter.....	A-5546
Hydraulic Oil Filter.....	H-55270
Hydraulic Oil Filter.....	H-5506
814B (DOZERS) S/N: 16Z307-UP	
Air Filter Secondary.....	A-5550
Air Filter Set.....	A-5522-S
Air Filter Primary.....	A-5509
Air Filter.....	A-5546
Air Filter Primary.....	A-5549M
Air Filter Set.....	A-5549M-S
Air Filter Secondary.....	A-5522
Air Filter Primary.....	A-5549
Hydraulic Oil Filter.....	H-5506
Hydraulic Oil Filter.....	H-55270
814F (DOZERS) CAT (S/N: 08Z86460-UP)	

MODEL/APPLICATION	SAKURA NO
CATERPILLAR	
Fuel Filter Secondary.....	FC-5507
Oil Filter Full Flow.....	C-5522
Oil Filter Full Flow.....	C-5510
814F (DOZERS) CAT (S/N: 3PD1-UP)	
Fuel Filter.....	FC-5517
Oil Filter Full Flow.....	C-5516
814F (DOZERS) CAT (S/N: 6NC1-UP)	
Fuel Filter.....	FC-5509
Fuel Filter Secondary.....	FC-5507
Oil Filter Full Flow.....	C-5522
Oil Filter Full Flow.....	C-5516
814F (DOZERS) CAT (S/N: 9DM1-UP)	
Air Filter Primary.....	A-5558
Air Filter Secondary.....	A-5559
Cabin Air Filter.....	CA-55070
Hydraulic Oil Filter.....	H-55270
Hydraulic Oil Filter.....	H-5506
814F (DOZERS) CAT (S/N: BGF1-UP)	
Air Filter Secondary.....	A-5556
Air Filter Primary.....	A-5555
Air Filter Set.....	A-5555-S
Cabin Air Filter.....	CA-55070
Hydraulic Oil Filter.....	H-5506
Hydraulic Oil Filter.....	H-55270
814F II (DOZERS) CAT S/N: BXG1-UP	
Air Filter Primary.....	A-5555
Air Filter Set.....	A-5555-S
Air Filter Secondary.....	A-5556
Cabin Air Filter.....	CA-55070
Fuel Filter.....	FC-5517
Hydraulic Oil Filter.....	H-5506
Hydraulic Oil Filter.....	H-55270
814F II (DOZERS) CAT S/N: THX286-UP	
Air Filter Secondary.....	A-5556
Air Filter Set.....	A-5555-S
Air Filter Primary.....	A-5555
Cabin Air Filter.....	CA-55070
Fuel Filter.....	FC-5517
Hydraulic Oil Filter.....	H-55270
Hydraulic Oil Filter.....	H-5506
815 (COMPACTORS)	
Fuel Filter.....	F-5503
815 (COMPACTORS) S/N: 15R1 EXC. 91P925-UP	
Air Filter Set.....	A-5522-S
Air Filter Secondary.....	A-5510
Air Filter Primary.....	A-5509
Air Filter Secondary.....	A-5550
Air Filter Set.....	A-5522-S
Fuel Filter Secondary.....	FC-5507
Hydraulic Oil Filter.....	H-5504
Hydraulic Oil Filter.....	H-5503
Oil Filter Full Flow.....	C-5510
Oil Filter Full Flow.....	O-5502
815 (COMPACTORS) S/N: 91P1-91P243	
Air Filter Secondary.....	A-5520
Air Filter Primary.....	A-5558
Air Filter Set.....	A-5544-S
Air Filter Primary.....	A-5543
Air Filter Secondary.....	A-5559
Fuel Filter Secondary.....	FC-5507
Hydraulic Oil Filter.....	H-5504
Hydraulic Oil Filter.....	H-5503
Oil Filter Full Flow.....	O-5502
815 (COMPACTORS) S/N: 91P244-919	
Air Filter Set.....	A-5522-S
Air Filter Secondary.....	A-5510
Air Filter Primary.....	A-5509
Air Filter Secondary.....	A-5550
Air Filter Set.....	A-5549M-S
Air Filter Primary.....	A-5549M
Air Filter Primary.....	A-5549
Fuel Filter Secondary.....	FC-5507
Hydraulic Oil Filter.....	H-5503
Hydraulic Oil Filter.....	H-5504
Oil Filter Full Flow.....	O-5501
Oil Filter Full Flow.....	C-5510
Oil Filter Full Flow.....	O-5502
815 (COMPACTORS) S/N: 91P920-UP	
Air Filter Primary.....	A-5549
Air Filter Primary.....	A-5549M
Air Filter Set.....	A-5549M-S
Air Filter Secondary.....	A-5550
Air Filter Primary.....	A-5509
Air Filter Secondary.....	A-5510
Air Filter Set.....	A-5522-S
Fuel Filter Secondary.....	FC-5507
Hydraulic Oil Filter.....	H-5504
Hydraulic Oil Filter.....	H-5503
Oil Filter Full Flow.....	C-5510
815 (COMPACTORS) S/N: 91P925-925	
Air Filter Set.....	A-5522-S

MODEL/APPLICATION	SAKURA NO
CATERPILLAR	
Fuel Filter Secondary.....	FC-5507
Hydraulic Oil Filter.....	H-5504
Hydraulic Oil Filter.....	H-5503
Oil Filter Full Flow.....	C-5510
815 (COMPACTORS) S/N: 15R1-UP	
Air Filter Primary.....	A-5549
Air Filter Primary.....	A-5549M
Air Filter Set.....	A-5549M-S
Air Filter Secondary.....	A-5550
Air Filter Primary.....	A-5509
Air Filter Secondary.....	A-5510
Air Filter Set.....	A-5522-S
Fuel Filter Secondary.....	FC-5507
Hydraulic Oil Filter.....	H-5503
Hydraulic Oil Filter.....	H-5504
Oil Filter Full Flow.....	C-5510
815 (COMPACTORS) S/N: 91P1-91P243	
Air Filter Secondary.....	A-5520
Air Filter Primary.....	A-5558
Air Filter Set.....	A-5544-S
Air Filter Primary.....	A-5543
Air Filter Secondary.....	A-5559
Fuel Filter Secondary.....	FC-5507
Hydraulic Oil Filter.....	H-5504
Hydraulic Oil Filter.....	H-5503
Oil Filter Full Flow.....	O-5502
815 (COMPACTORS) S/N: 91P244-919	
Air Filter Set.....	A-5522-S
Air Filter Secondary.....	A-5510
Air Filter Primary.....	A-5509
Air Filter Secondary.....	A-5550
Air Filter Set.....	A-5549M-S
Air Filter Primary.....	A-5549M
Air Filter Primary.....	A-5549
Fuel Filter Secondary.....	FC-5507
Hydraulic Oil Filter.....	H-5503
Hydraulic Oil Filter.....	H-5504
Oil Filter Full Flow.....	O-5501
Oil Filter Full Flow.....	C-5510
Oil Filter Full Flow.....	O-5502
815 (COMPACTORS) S/N: 91P920-UP	
Air Filter Primary.....	A-5549
Air Filter Primary.....	A-5549M
Air Filter Set.....	A-5549M-S
Air Filter Secondary.....	A-5550
Air Filter Primary.....	A-5509
Air Filter Secondary.....	A-5510
Air Filter Set.....	A-5522-S
Fuel Filter Secondary.....	FC-5507
Hydraulic Oil Filter.....	H-5504
Hydraulic Oil Filter.....	H-5503
Oil Filter Full Flow.....	C-5510
815 (COMPACTORS) S/N: 91P925-925	
Air Filter Set.....	A-5522-S

Sakura Filter

ENGINE APPLICATION

MODEL/APPLICATION	SAKURA NO	MODEL/APPLICATION	SAKURA NO	MODEL/APPLICATION	SAKURA NO
CATERPILLAR		CATERPILLAR		CATERPILLAR	
815 (COMPACTORS) S/N: 91P925-925 Air Filter Secondary..... A-5510 Air Filter Primary..... A-5509 Air Filter Secondary..... A-5550 Air Filter Set..... A-5549M-S Air Filter Primary..... A-5549M Air Filter Primary..... A-5549 Fuel Filter Secondary..... FC-5507 Hydraulic Oil Filter..... H-5504 Hydraulic Oil Filter..... H-5503 Oil Filter Full Flow..... O-5502 Oil Filter Full Flow..... O-5501 Oil Filter Full Flow..... C-5510		815F (COMPACTORS) w/C9 Eng. Fuel/Water Separator..... SFC-55170 815F II (COMPACTORS) CAT S/N: BYN1-UP Air Filter Secondary..... A-5556 Air Filter Primary..... A-5555 Air Filter Set..... A-5555-S Cabin Air Filter..... CA-55070 Fuel Filter..... FC-5517 Hydraulic Oil Filter..... H-5506 Hydraulic Oil Filter..... H-55270 815F II (COMPACTORS) CAT S/N: THX1-UP Air Filter Set..... A-5555-S Air Filter Primary..... A-5555 Air Filter Secondary..... A-5556 Cabin Air Filter..... CA-55070 Fuel Filter..... FC-5517 Hydraulic Oil Filter..... H-55270 Hydraulic Oil Filter..... H-5506		Air Filter Secondary..... A-5522 Air Filter Primary..... A-5549 Air Filter Primary..... A-5549M Air Filter Set..... A-5549M-S Air Filter Secondary..... A-5550 Air Filter..... A-5546 Fuel Filter..... F-5505 Fuel Filter Secondary..... FC-5507 Hydraulic Oil Filter..... H-5504 Hydraulic Oil Filter..... H-5506 Hydraulic Oil Filter..... H-55270 Oil Filter Full Flow..... C-5510 816F (COMPACTORS) 3176C Fuel/Water Separator..... SFC-55170 816F (COMPACTORS) w/C9 Eng. Fuel/Water Separator..... SFC-55170 816F II (COMPACTORS) CAT S/N: BZR1-UP Air Filter Secondary..... A-5556 Air Filter Set..... A-5555-S Air Filter Primary..... A-5555 Cabin Air Filter..... CA-55070 Fuel Filter..... FC-5517 Hydraulic Oil Filter..... H-5506 Hydraulic Oil Filter..... H-55270 816F II (COMPACTORS) CAT S/N: THX1-UP Air Filter Primary..... A-5555 Air Filter Set..... A-5555-S Air Filter Secondary..... A-5556 Cabin Air Filter..... CA-55070 Fuel Filter..... FC-5517 Hydraulic Oil Filter..... H-55270 Hydraulic Oil Filter..... H-5506	
815 (COMPACTORS) S/N: EXC. 91P-UP Air Filter Primary..... A-5549 Air Filter Primary..... A-5549M Air Filter Set..... A-5549M-S Air Filter Secondary..... A-5550 Air Filter Primary..... A-5509 Air Filter Secondary..... A-5510 Air Filter Set..... A-5522-S Fuel Filter Secondary..... FC-5507 Hydraulic Oil Filter..... H-5504 Hydraulic Oil Filter..... H-5503 Oil Filter Full Flow..... C-5510 Oil Filter Full Flow..... O-5501 Oil Filter Full Flow..... O-5502		816 (COMPACTORS) S/N: 15U1-UP Air Filter Set..... A-5522-S Air Filter Secondary..... A-5510 Air Filter Primary..... A-5509 Fuel Filter..... FC-5501 Hydraulic Oil Filter..... H-5502 Hydraulic Oil Filter..... H-5508 Hydraulic Oil Filter..... H-5504 Oil Filter Full Flow..... C-5510 816 (COMPACTORS) S/N: 15Z1-UP Air Filter Primary..... A-5509 Air Filter Set..... A-5522-S Air Filter Secondary..... A-5522 Fuel Filter..... FC-5519 Hydraulic Oil Filter..... H-5504 Hydraulic Oil Filter..... H-5506 Oil Filter Full Flow..... C-5510 816 (COMPACTORS) S/N: 57U1-UP Air Filter Set..... A-5522-S Air Filter Secondary..... A-5510 Air Filter Primary..... A-5509 Air Filter Secondary..... A-5550 Air Filter Set..... A-5549M-S Air Filter Primary..... A-5549M Air Filter Primary..... A-5549 Fuel Filter Secondary..... FC-5507 Hydraulic Oil Filter..... H-5502 Hydraulic Oil Filter..... H-5504 Hydraulic Oil Filter..... H-5508 Oil Filter Full Flow..... C-5510 816B (COMPACTORS) S/N: 15Z1-UP Air Filter Primary..... A-5509 Air Filter Set..... A-5522-S		816 (COMPACTORS) S/N: 15U1-UP Air Filter Set..... A-5522-S Air Filter Secondary..... A-5510 Air Filter Primary..... A-5509 Fuel Filter..... FC-5501 Hydraulic Oil Filter..... H-5502 Hydraulic Oil Filter..... H-5508 Hydraulic Oil Filter..... H-5504 Oil Filter Full Flow..... C-5510 816 (COMPACTORS) S/N: 15Z1-UP Air Filter Primary..... A-5509 Air Filter Set..... A-5522-S 816B (COMPACTORS) S/N: 15Z1-UP Air Filter Primary..... A-5509 Air Filter Set..... A-5522-S	
815 (COMPACTORS) w/3306 Eng. Hydraulic Oil Filter..... H-55320 815B (COMPACTORS) S/N: 17Z1-UP Air Filter Primary..... A-5509 Air Filter Set..... A-5522-S Air Filter Secondary..... A-5522 Air Filter Primary..... A-5549 Air Filter Primary..... A-5549M Air Filter Set..... A-5549M-S Air Filter Secondary..... A-5550 Air Filter..... A-5546 Fuel Filter..... F-5505 Fuel Filter Secondary..... FC-5507 Hydraulic Oil Filter..... H-5504 Hydraulic Oil Filter..... H-5506 Oil Filter Full Flow..... C-5510		815F (COMPACTORS) 3176C Fuel/Water Separator..... SFC-55170 815F (COMPACTORS) CAT 3176C ATAAC (S/N: 1GN1-UP) Air Filter Primary..... A-5558 Air Filter Secondary..... A-5559 Fuel Filter Secondary..... FC-5507 Hydraulic Oil Filter..... H-5506 Hydraulic Oil Filter..... H-5504		824C (DOZERS) CAT 3406 Air Filter Set..... A-44150-S Air Filter Primary..... A-44150 824C (DOZERS) CAT (S/N: 11N1-UP) Fuel Filter..... FC-5509 Fuel Filter..... FC-5519 824C (DOZERS) CAT (S/N: 70V14539-16375) Fuel Filter..... FC-5509 824C (DOZERS) CAT (S/N: 70V16376-UP) Fuel Filter..... FC-5509 824C (DOZERS) CAT (S/N: BKN1-UP) Fuel Filter..... FC-5509 Fuel Filter..... FC-5517 824C (DOZERS) S/N: 29G1-UP Air Filter Set..... A-5522-S	

Sakura Filter

ENGINE APPLICATION

MODEL/APPLICATION	SAKURA NO	MODEL/APPLICATION	SAKURA NO	MODEL/APPLICATION	SAKURA NO
CATERPILLAR		CATERPILLAR		CATERPILLAR	
824C (DOZERS) S/N: 29G1-UP		Hydraulic Oil Filter.....	H-55270	Air Filter Primary.....	A-5555
Air Filter Secondary.....	A-5510	824C (DOZERS) S/N: 85X1584-UP		Air Filter Secondary.....	A-5556
Air Filter Primary.....	A-5509	Air Filter Secondary.....	A-5534	Fuel Filter.....	FC-5517
Air Filter Secondary.....	A-5550	Air Filter.....	A-5546	Fuel Filter.....	FC-5509
Air Filter Set.....	A-5549M-S	Air Filter Primary.....	A-5535	Fuel/Water Separator Secondary..	SFC-5504-10B
Air Filter Primary.....	A-5549M	Air Filter Set.....	A-5573-S	Fuel/Water Separator Secondary..	SFC-5504-10
Air Filter Primary.....	A-5549	Hydraulic Oil Filter.....	H-5504	Hydraulic Oil Filter.....	H-5506
Fuel Filter.....	F-5501	Hydraulic Oil Filter.....	H-55270	Hydraulic Oil Filter.....	H-55280
Hydraulic Oil Filter.....	H-5503	Hydraulic Oil Filter.....	H-5506	Hydraulic Oil Filter.....	H-5526
Oil Filter Full Flow.....	O-5503	824C (DOZERS) S/N: 85X1-UP		Oil Filter Full Flow.....	C-5516
824C (DOZERS) S/N: 36H1-UP		Air Filter Set.....	A-5573-S	824H (DOZERS) CAT S/N: ASX1-299-UP	
Air Filter Primary.....	A-5558	Air Filter Primary.....	A-5535	Air Filter Primary.....	A-5593
Air Filter Secondary.....	A-5559	Air Filter.....	A-5546	Air Filter Set.....	A-5595-S
Air Filter Primary.....	A-5543	Air Filter Primary.....	A-5501	Air Filter Secondary.....	A-5594
Air Filter Set.....	A-5544-S	Air Filter Secondary.....	A-5534	Air Filter.....	A-5584
Air Filter Secondary.....	A-5520	Air Filter Secondary.....	A-5502	Fuel Filter.....	FC-5517
Fuel Filter.....	F-5501	Fuel Filter.....	F-5505	Hydraulic Oil Filter.....	H-5506
Hydraulic Oil Filter.....	H-5503	Fuel Filter.....	FC-5519	Hydraulic Oil Filter.....	H-55280
Oil Filter Full Flow.....	O-5503	Fuel Filter.....	FC-5509	Hydraulic Oil Filter.....	H-5526
824C (DOZERS) S/N: 85X1045-1158		Hydraulic Oil Filter.....	H-5506	824H (DOZERS) CAT S/N: ASX300-UP	
Air Filter Secondary.....	A-5502	Hydraulic Oil Filter.....	H-5504	Air Filter.....	A-5584
Air Filter Primary.....	A-5501	Oil Filter Full Flow.....	C-5516	Air Filter Secondary.....	A-5594
Air Filter.....	A-5546	824C (DOZERS) S/N: 85X564-836		Air Filter Set.....	A-5595-S
Hydraulic Oil Filter.....	H-55270	Air Filter Secondary.....	A-5502	Air Filter Primary.....	A-5593
824C (DOZERS) S/N: 85X1159-1159		Air Filter Primary.....	A-5501	Fuel Filter.....	FC-5517
Air Filter Primary.....	A-5501	Air Filter Secondary.....	A-5502	Hydraulic Oil Filter.....	H-5526
Air Filter Secondary.....	A-5502	Air Filter.....	A-5546	Hydraulic Oil Filter.....	H-55280
Hydraulic Oil Filter.....	H-55270	Hydraulic Oil Filter.....	H-55270	Hydraulic Oil Filter.....	H-5526
Hydraulic Oil Filter.....	H-5506	824C (DOZERS) S/N: 85X837-1044		824H (DOZERS) CAT S/N: LHX1-UP	
824C (DOZERS) S/N: 85X1160-1175		Air Filter.....	A-5546	Air Filter Primary.....	A-5593
Air Filter Secondary.....	A-5502	Air Filter Primary.....	A-5501	Air Filter Set.....	A-5595-S
Air Filter Primary.....	A-5501	Air Filter Secondary.....	A-5502	Air Filter Secondary.....	A-5594
Air Filter.....	A-5546	Hydraulic Oil Filter.....	H-55270	Air Filter.....	A-5584
Hydraulic Oil Filter.....	H-55270	824C (DOZERS) w/3406 Eng.		Fuel Filter.....	FC-5517
824C (DOZERS) S/N: 85X1176-1193		Air Filter Set.....	A-5573M-S	Hydraulic Oil Filter.....	H-5506
Air Filter.....	A-5546	Air Filter Primary.....	A-5535M	Hydraulic Oil Filter.....	H-55280
Air Filter Primary.....	A-5501	824G II (DOZERS) CAT S/N: AWM1-UP		Hydraulic Oil Filter.....	H-5526
Air Filter Secondary.....	A-5502	Air Filter Secondary.....	A-5556	Hydraulic Oil Filter.....	H-5506
Hydraulic Oil Filter.....	H-55270	Air Filter Primary.....	A-5555	824H (DOZERS) CAT S/N: ZBD1-UP	
Hydraulic Oil Filter.....	H-5506	Air Filter Set.....	A-5555-S	Air Filter.....	A-5584
824C (DOZERS) S/N: 85X1194-1583		Air Filter.....	A-5584	Air Filter Secondary.....	A-5594
Air Filter Secondary.....	A-5502	Fuel Filter.....	FC-5509	Air Filter Set.....	A-5595-S
Air Filter Primary.....	A-5501	Fuel/Water Separator Secondary..	SFC-5504-10B	Air Filter Primary.....	A-5593
Air Filter.....	A-5546	Fuel/Water Separator Secondary..	SFC-5504-10	Fuel Filter.....	FC-5517
Hydraulic Oil Filter.....	H-5506	Hydraulic Oil Filter.....	H-5506	Hydraulic Oil Filter.....	H-5526
Hydraulic Oil Filter.....	H-55270	Hydraulic Oil Filter.....	H-5526	Hydraulic Oil Filter.....	H-55280
Hydraulic Oil Filter.....	H-5504	Hydraulic Oil Filter.....	H-55280	Hydraulic Oil Filter.....	H-5506
824C (DOZERS) S/N: 85X1-563		Oil Filter Full Flow.....	C-5516	824G (DOZERS) CAT (S/N: 41Z212-UP)	
Air Filter Primary.....	A-5501	824G II (DOZERS) CAT S/N: BKN1-UP		Fuel Filter.....	FC-5509
Air Filter Secondary.....	A-5502	Air Filter.....	A-5584	Oil Filter Full Flow.....	C-5516
824C (DOZERS) S/N: 85X1-563		Air Filter Set.....	A-5555-S	824G (DOZERS)	
Air Filter Primary.....	A-5501	Air Filter.....	A-5584	Air Filter Set.....	A-5573M-S
Air Filter Secondary.....	A-5502	Air Filter Set.....	A-5555-S	Air Filter Primary.....	A-5535M

MODEL/APPLICATION	SAKURA NO	MODEL/APPLICATION	SAKURA NO	MODEL/APPLICATION	SAKURA NO
CATERPILLAR		CATERPILLAR		CATERPILLAR	
824G (DOZERS)		825C (COMPACTORS) w/3406 Eng.		Air Filter Set.....	A-5595-S
Air Filter Primary.....	A-5555	Air Filter Set.....	A-5573M-S	Air Filter Secondary.....	A-5594
Fuel Filter.....	FC-5509	Air Filter Primary.....	A-5535M	Air Filter Primary.....	A-5593
Oil Filter Full Flow.....	C-5516			Air Filter.....	A-5584
		825G (COMPACTORS) CAT 3406E ATAAC		Fuel Filter.....	FC-5517
824G (DOZERS) S/N: 45N1-320		Air Filter Secondary.....	A-5556	Hydraulic Oil Filter.....	H-55280
Air Filter Primary.....	A-5535	Air Filter Primary.....	A-5555	Hydraulic Oil Filter.....	H-5526
Air Filter.....	A-5584	Air Filter Set.....	A-5555-S	Hydraulic Oil Filter.....	H-5506
Air Filter Set.....	A-5573-S	Fuel Filter.....	FC-5506		
Air Filter Secondary.....	A-5534	Hydraulic Oil Filter.....	H-5506	825H (COMPACTORS) CAT S/N: ZHC1-UP	
Hydraulic Oil Filter.....	H-5506	Hydraulic Oil Filter.....	H-5504	Air Filter.....	A-5584
Hydraulic Oil Filter.....	H-55270			Air Filter Primary.....	A-5593
		825G (COMPACTORS) CAT 3406E ATAAC (S/N: 6RN1-UP)		Air Filter Secondary.....	A-5594
824G (DOZERS) S/N: 45N321-UP		Air Filter Set.....	A-5555-S	Air Filter Set.....	A-5595-S
Air Filter Primary.....	A-5555	Air Filter Primary.....	A-5555	Fuel Filter.....	FC-5517
Air Filter Set.....	A-5555-S	Air Filter Secondary.....	A-5556	Hydraulic Oil Filter.....	H-5506
Air Filter.....	A-5584	Air Filter.....	A-5584	Hydraulic Oil Filter.....	H-5526
Air Filter Secondary.....	A-5556	Air Filter Set.....	A-5573-S	Hydraulic Oil Filter.....	H-55280
Hydraulic Oil Filter.....	H-55270	Air Filter Secondary.....	A-5534		
Hydraulic Oil Filter.....	H-5506	Air Filter Primary.....	A-5535	825H (COMPACTORS) W/C15 ENG.	
		Coolant Filter.....	WC-5707	Fuel/Water Separator.....	SFC-55170
824K (DOZERS) W/C15 ENG.		Coolant Filter.....	WC-5705		
Fuel/Water Separator.....	SFC-55250	Fuel Filter.....	FC-5509	825K (COMPACTORS) W/C15 ENG.	
		Fuel Filter.....	F-5505	Fuel/Water Separator.....	SFC-55250
825 (COMPACTORS) S/N: 43N1-43N493		Hydraulic Oil Filter.....	H-5504		
Air Filter Secondary.....	A-5520	Hydraulic Oil Filter.....	H-55270	826 (COMPACTORS) S/N: 58U1-UP	
Air Filter Primary.....	A-5543	Hydraulic Oil Filter.....	H-5506	Air Filter Secondary.....	A-5520
Air Filter Primary.....	A-5558	Oil Filter Full Flow.....	C-5516	Air Filter Set.....	A-5544-S
Air Filter Set.....	A-5544-S			Air Filter Primary.....	A-5543
Air Filter Secondary.....	A-5559	825G (COMPACTORS) w/3406 Eng.		Hydraulic Oil Filter.....	H-5503
Hydraulic Oil Filter.....	H-5503	Air Filter Primary.....	A-5535M	Oil Filter Full Flow.....	O-5503
Oil Filter Full Flow.....	O-5503	Air Filter Set.....	A-5573M-S		
				826B (COMPACTORS) S/N: 58U1-UP	
825 (COMPACTORS) S/N: 43N494-UP		825G II (COMPACTORS) CAT 3406 (S/N: AXB1-437)		Air Filter Secondary.....	A-5520
Air Filter Secondary.....	A-5559	Hydraulic Oil Filter.....	H-5506	Air Filter Primary.....	A-5543
Air Filter Set.....	A-5544-S			Air Filter Set.....	A-5544-S
Air Filter Primary.....	A-5558	825G II (COMPACTORS) CAT 3406 (S/N: AXB1-UP)		Air Filter Primary.....	A-5558
Air Filter Primary.....	A-5543	Air Filter Set.....	A-5555-S	Air Filter Secondary.....	A-5559
Air Filter Secondary.....	A-5520	Air Filter Primary.....	A-5555	Fuel Filter Secondary.....	FC-5507
Fuel Filter Secondary.....	FC-5507	Air Filter Secondary.....	A-5556	Hydraulic Oil Filter.....	H-5503
Hydraulic Oil Filter.....	H-5503	Air Filter.....	A-5584	Oil Filter Full Flow.....	O-5503
Oil Filter Full Flow.....	O-5503	Fuel Filter.....	FC-5517		
		Hydraulic Oil Filter.....	H-5526	826C (COMPACTORS) S/N: 87X1-UP	
825C (COMPACTORS) S/N: 86X1-UP		Oil Filter Full Flow.....	C-5516	Air Filter Secondary.....	A-5534
Air Filter Secondary.....	A-5534			Air Filter Secondary.....	A-5502
Air Filter Primary.....	A-5501	825H (COMPACTORS) CAT S/N: AZW1-299-UP		Air Filter Primary.....	A-5501
Air Filter Secondary.....	A-5502	Air Filter.....	A-5584	Air Filter.....	A-5546
Air Filter.....	A-5546	Air Filter Primary.....	A-5593	Air Filter Primary.....	A-5535
Air Filter Primary.....	A-5535	Air Filter Secondary.....	A-5594	Air Filter Set.....	A-5573-S
Air Filter Set.....	A-5573-S	Air Filter Set.....	A-5595-S	Fuel Filter.....	FC-5509
Fuel Filter.....	F-5505	Fuel Filter.....	FC-5517	Fuel Filter.....	FC-5519
Fuel Filter.....	FC-5509	Hydraulic Oil Filter.....	H-5506	Hydraulic Oil Filter.....	H-5504
Hydraulic Oil Filter.....	H-5504	Hydraulic Oil Filter.....	H-5526	Hydraulic Oil Filter.....	H-5506
Hydraulic Oil Filter.....	H-5506	Hydraulic Oil Filter.....	H-55280	Oil Filter Full Flow.....	C-5516
Oil Filter Full Flow.....	C-5516				
		825H (COMPACTORS) CAT S/N: LHX1-UP		826C (COMPACTORS) w/3406 Eng.	
Air Filter Secondary.....	A-5534	Air Filter.....	A-5584	Air Filter Set.....	A-5573M-S
Air Filter Primary.....	A-5501	Air Filter Primary.....	A-5593	Air Filter Primary.....	A-5535M
Air Filter Secondary.....	A-5502	Air Filter Secondary.....	A-5594		
Air Filter.....	A-5546	Air Filter Set.....	A-5595-S		
Air Filter Primary.....	A-5535	Fuel Filter.....	FC-5517		
Air Filter Set.....	A-5573-S	Hydraulic Oil Filter.....	H-5506		
Fuel Filter.....	F-5505	Hydraulic Oil Filter.....	H-5526		
Fuel Filter.....	FC-5509	Hydraulic Oil Filter.....	H-55280		
Hydraulic Oil Filter.....	H-5504				
Hydraulic Oil Filter.....	H-5506				
Oil Filter Full Flow.....	C-5516				

MODEL/APPLICATION	SAKURA NO	MODEL/APPLICATION	SAKURA NO	MODEL/APPLICATION	SAKURA NO
CATERPILLAR		CATERPILLAR		CATERPILLAR	
826G <i>(COMPACTORS)</i> w/3406 Eng. Air Filter Primary..... A-5535M Air Filter Set..... A-5573M-S 826G II <i>(COMPACTORS)</i> CAT S/N: AYH1-UP Air Filter Primary..... A-5555 Air Filter Set..... A-5555-S Air Filter Secondary..... A-5556 Air Filter..... A-5584 Fuel Filter..... FC-5517 Fuel Filter..... FC-5509 Fuel/Water Separator Secondary.. SFC-5504-10B Fuel/Water Separator Secondary.. SFC-5504-10 Hydraulic Oil Filter..... H-5506 Hydraulic Oil Filter..... H-55280 Hydraulic Oil Filter..... H-5526 Oil Filter Full Flow..... C-5516 826G II <i>(COMPACTORS)</i> CAT S/N: BKN1-UP Air Filter..... A-5584 Air Filter Secondary..... A-5556 Air Filter Set..... A-5555-S Air Filter Primary..... A-5555 Fuel Filter..... FC-5509 Fuel Filter..... FC-5517 Fuel/Water Separator Secondary.. SFC-5504-10B Fuel/Water Separator Secondary.. SFC-5504-10 Hydraulic Oil Filter..... H-5526 Hydraulic Oil Filter..... H-55280 Hydraulic Oil Filter..... H-5506 Oil Filter Full Flow..... C-5516 826G II <i>(COMPACTORS)</i> w/3406 Eng. Fuel/Water Separator..... SFC-55170 826H <i>(COMPACTORS)</i> CAT (S/N: LHX1-UP) Fuel Filter..... FC-5517 826H <i>(COMPACTORS)</i> S/N: AWF1-UP Air Filter..... A-5584 Air Filter Primary..... A-5593 Air Filter Set..... A-5595-S Air Filter Secondary..... A-5594 Hydraulic Oil Filter..... H-5506 Hydraulic Oil Filter..... H-5526 Hydraulic Oil Filter..... H-55280 826H <i>(COMPACTORS)</i> S/N: ZXT1-UP Air Filter Set..... A-5595-S Air Filter Primary..... A-5593 Air Filter..... A-5584 Air Filter Secondary..... A-5594 Hydraulic Oil Filter..... H-5526 Hydraulic Oil Filter..... H-55280 Hydraulic Oil Filter..... H-5506		826H <i>(COMPACTORS)</i> W/C15 ENG. Fuel/Water Separator..... SFC-55170 826K <i>(COMPACTORS)</i> W/C15 ENG. Fuel/Water Separator..... SFC-55250 82DC <i>(DOZERS)</i> Air Filter Primary..... A-5501 Air Filter Secondary..... A-5502 Coolant Filter..... WC-5707 Fuel Filter..... FC-5502 Hydraulic Oil Filter..... H-5506 Hydraulic Oil Filter..... H-5504 Oil Filter Full Flow..... C-5516 834B <i>(DOZERS)</i> CAT (S/N: 48W15340-19874) Fuel Filter..... FC-5509 834B <i>(DOZERS)</i> CAT (S/N: 48W19875-26423) Fuel Filter..... FC-5509 834B <i>(DOZERS)</i> CAT (S/N: 48W26424-UP) Fuel Filter..... FC-5509 834B <i>(DOZERS)</i> CAT (S/N: 48W9818-15339) Fuel Filter..... FC-5509 834B <i>(DOZERS)</i> CAT (S/N: 99C1-UP) Fuel Filter..... FC-5509 Fuel/Water Separator Secondary.. SFC-5504-10B Fuel/Water Separator Secondary.. SFC-5504-10 834B <i>(DOZERS)</i> CAT 3408 (S/N: 92Z1-UP) Air Filter Set..... A-5521-S Air Filter Primary..... A-5521 Fuel Filter..... FC-5509 Hydraulic Oil Filter..... H-5504 Hydraulic Oil Filter..... H-5509 Oil Filter Full Flow..... C-5516 834B <i>(DOZERS)</i> CAT 3408E (S/N: 92Z1-UP) Air Filter Primary..... A-5521 Air Filter Set..... A-5521-S Fuel Filter..... FC-5509 Hydraulic Oil Filter..... H-5509 Hydraulic Oil Filter..... H-5504 Oil Filter Full Flow..... C-5516 834B <i>(DOZERS)</i> S/N: 7BR1-UP Air Filter Secondary..... A-5556 Air Filter Set..... A-5555-S Air Filter Primary..... A-5555 Hydraulic Oil Filter..... H-5509 Hydraulic Oil Filter..... HC-5504 Hydraulic Oil Filter..... H-55270		834B <i>(DOZERS)</i> S/N: 92Z1-327 Air Filter Secondary..... A-5529 Air Filter Set..... A-5521-S Air Filter Primary..... A-5521 Hydraulic Oil Filter..... H-55270 834B <i>(DOZERS)</i> S/N: 92Z328-328 Air Filter Primary..... A-5521 Air Filter Set..... A-5521-S Air Filter Secondary..... A-5529 Hydraulic Oil Filter..... H-55270 834B <i>(DOZERS)</i> S/N: 92Z329-378 Hydraulic Oil Filter..... H-55270 834B <i>(DOZERS)</i> S/N: 92Z379-UP Hydraulic Oil Filter..... H-55270 Hydraulic Oil Filter..... H-5509 834G <i>(DOZERS)</i> CAT (S/N: 7RC1515-UP) Fuel Filter..... FC-5509 834G <i>(DOZERS)</i> CAT (S/N: BNT10129-UP) Fuel Filter..... FC-5509 834G <i>(DOZERS)</i> CAT S/N: 7RC1-1514 Fuel Filter..... FC-5509 Oil Filter Full Flow..... C-5516 834G <i>(DOZERS)</i> CAT S/N: BNT1-10128 Fuel Filter..... FC-5509 Oil Filter Full Flow..... C-5516 834G <i>(DOZERS)</i> S/N: BPC1-UP Air Filter..... A-5584 Air Filter Set..... A-5565-S Air Filter Secondary..... A-5563 Air Filter Primary..... A-5564 Fuel/Water Separator Secondary.. SFC-5504-10 Fuel/Water Separator Secondary.. SFC-5504-10B Hydraulic Oil Filter..... HC-5504 Hydraulic Oil Filter..... HC-5512 834H <i>(DOZERS)</i> CAT (S/N: RHX1-UP) Fuel Filter..... FC-5517 Fuel Filter..... FC-5510 Oil Filter Full Flow..... C-7906 834H <i>(DOZERS)</i> CAT C18TA ACERT Cabin Air Filter..... CA-55120 834H <i>(DOZERS)</i> S/N: BTX1-UP Air Filter..... A-5584 Air Filter Primary..... A-5593 Air Filter Secondary..... A-5594	

MODEL/APPLICATION	SAKURA NO	MODEL/APPLICATION	SAKURA NO	MODEL/APPLICATION	SAKURA NO
CATERPILLAR		CATERPILLAR		CATERPILLAR	
834H (DOZERS) S/N: BTX1-UP		Hydraulic Oil Filter Suction.....	H-5516	Hydraulic Oil Filter.....	HC-5512
Air Filter Set.....	A-5595-S	836 (COMPACTORS) CAT 3408 (S/N: 7FR1-263-UP)		Hydraulic Oil Filter.....	HC-5504
Hydraulic Oil Filter.....	HC-5504	Air Filter Set.....	A-5521-S	836H (COMPACTORS) S/N: BXD430-UP	
Hydraulic Oil Filter.....	HC-5512	Air Filter Primary.....	A-5521	Air Filter Secondary.....	A-5594
834H (DOZERS) S/N: XDC1-UP		Air Filter Secondary.....	A-5529	Air Filter Set.....	A-5595-S
Air Filter.....	A-5584	Fuel Filter.....	FC-5509	Air Filter Primary.....	A-5593
Air Filter Set.....	A-5595-S	Fuel/Water Separator Secondary..	SFC-5504-10B	Air Filter.....	A-5584
Air Filter Secondary.....	A-5594	Fuel/Water Separator Secondary... SFC-5504-10		Hydraulic Oil Filter.....	HC-5504
Air Filter Primary.....	A-5593	Hydraulic Oil Filter.....	H-5504	836H (COMPACTORS) S/N: XTRI-UP	
Hydraulic Oil Filter.....	HC-5512	Hydraulic Oil Filter.....	H-5509	Air Filter.....	A-5584
Hydraulic Oil Filter.....	HC-5504	Oil Filter Full Flow.....	C-5516	Air Filter Primary.....	A-5593
834H (DOZERS) w/C18 Eng.		836 (COMPACTORS) CAT 3408 (S/N: 7FR1-264-UP)		Air Filter Set.....	A-5595-S
Fuel/Water Separator.....	SFC-55250	Air Filter Primary.....	A-5555	Air Filter Secondary.....	A-5594
834 (DOZERS) S/N: 43E1-UP		Air Filter Set.....	A-5555-S	Hydraulic Oil Filter.....	HC-5504
Air Filter Secondary.....	A-5520	Air Filter Secondary.....	A-5556	Hydraulic Oil Filter.....	HC-5512
Air Filter Set.....	A-5544-S	Fuel Filter.....	FC-5509	836H (COMPACTORS) w/C18 Eng.	
Air Filter Primary.....	A-5558	Fuel/Water Separator Secondary... SFC-5504-10		Fuel/Water Separator.....	SFC-55250
Air Filter Primary.....	A-5543	Fuel/Water Separator Secondary.. SFC-5504-10B		836C (COMPACTORS) S/N: 7FR1-225	
Air Filter Secondary.....	A-5559	Hydraulic Oil Filter.....	H-5509	Air Filter Secondary.....	A-5556
Fuel Filter.....	F-5501	Hydraulic Oil Filter.....	H-5504	Air Filter Set.....	A-5555-S
Hydraulic Oil Filter.....	H-5503	Oil Filter Full Flow.....	C-5516	Air Filter Primary.....	A-5555
Oil Filter Full Flow.....	0-5503	836 (COMPACTORS) S/N: 3RL1-UP		Fuel Filter.....	FC-5509
834 (DOZERS) S/N: 92Z1-UP		Air Filter Secondary.....	A-5529	Hydraulic Oil Filter.....	H-5504
Air Filter Primary.....	A-5521	Air Filter Primary.....	A-5521	Oil Filter Full Flow.....	C-5516
Air Filter Set.....	A-5521-S	Air Filter Set.....	A-5521-S	836K (COMPACTORS) w/C18 Eng.	
Air Filter Secondary.....	A-5529	Fuel Filter.....	F-5505	Fuel/Water Separator.....	SFC-55250
Oil Filter Full Flow.....	C-5516	Fuel Filter.....	FC-5509	844 (DOZERS) CAT 3412E	
834K (DOZERS) w/C18 Eng.		Hydraulic Oil Filter.....	H-55270	Air Filter Secondary.....	A-5556
Fuel/Water Separator.....	SFC-55250	Hydraulic Oil Filter.....	H-5504	Air Filter Primary.....	A-5555
835 (COMPACTORS) S/N: 44N1-298		Hydraulic Oil Filter.....	H-5509	Air Filter Set.....	A-5555-S
Air Filter Secondary.....	A-5520	Oil Filter Full Flow.....	C-5516	Fuel Filter.....	FC-5509
Air Filter Secondary.....	A-5559	836G (COMPACTORS) CAT 3456 DITA (S/N: 7MZ1-UP)		Hydraulic Oil Filter.....	H-5506
Air Filter Primary.....	A-5543	Air Filter.....	A-5584	Oil Filter Full Flow.....	C-5516
Air Filter Primary.....	A-5558	Air Filter Primary.....	A-5564	844 (DOZERS) CAT (S/N: 5JJ4077-4369)	
Air Filter Secondary.....	A-5558	Air Filter Secondary.....	A-5563	Fuel Filter.....	FC-5509
Air Filter Set.....	A-5544-S	Air Filter Set.....	A-5565-S	Hydraulic Oil Filter.....	H-5506
Fuel Filter Secondary.....	FC-5507	Fuel Filter.....	FC-5509	Oil Filter Full Flow.....	C-5516
Hydraulic Oil Filter.....	H-5503	Fuel/Water Separator Secondary... SFC-5504-10		844 (DOZERS) CAT S/N: 5JJ251-4071	
Oil Filter Full Flow.....	0-5503	Fuel/Water Separator Secondary.. SFC-5504-10B		Oil Filter Full Flow.....	C-5516
835 (COMPACTORS) S/N: 44N299-UP		Hydraulic Oil Filter.....	HC-5504	Oil Filter Full Flow.....	C-5516
Air Filter Set.....	A-5544-S	Hydraulic Oil Filter.....	HC-5503	844 (DOZERS) CAT S/N: 5JJ4370-UP	
Air Filter Primary.....	A-5558	Hydraulic Oil Filter.....	HC-5512	Oil Filter Full Flow.....	C-5510
Air Filter Primary.....	A-5543	Hydraulic Oil Filter.....	HC-5506	Oil Filter Full Flow.....	C-5516
Air Filter Secondary.....	A-5559	Oil Filter Full Flow.....	C-5516	844 (DOZERS) CAT S/N: 80M861-UP	
Air Filter Secondary.....	A-5520	836H (COMPACTORS) CAT (S/N: RHX1-UP)		Oil Filter Full Flow.....	C-5516
Fuel Filter Secondary.....	FC-5507	Fuel Filter.....	FC-5510	Oil Filter Full Flow.....	C-5510
Hydraulic Oil Filter.....	H-5503	Fuel Filter.....	FC-5517	844 (DOZERS) CAT S/N: 80M861-UP	
Oil Filter Full Flow.....	0-5503	Oil Filter Full Flow.....	C-7906	Oil Filter Full Flow.....	C-5516
835K (DOZERS) CAT C18 ACERT		836H (COMPACTORS) S/N: BXD1-429-UP		Oil Filter Full Flow.....	C-5510
		Air Filter.....	A-5584	844 (DOZERS) CAT 3412 TAE	
		Air Filter Primary.....	A-5593		
		Air Filter Set.....	A-5595-S		
		Air Filter Secondary.....	A-5594		

Sakura Filter

ENGINE APPLICATION

MODEL/APPLICATION	SAKURA NO	MODEL/APPLICATION	SAKURA NO	MODEL/APPLICATION	SAKURA NO
CATERPILLAR		CATERPILLAR		CATERPILLAR	
844 (DOZERS) CAT 3412 TAE Cabin Air Filter..... CA-55120		Air Filter Secondary..... A-5556 Fuel Filter..... FC-5510 Hydraulic Oil Filter..... H-55280 Hydraulic Oil Filter..... H-5506 Hydraulic Oil Filter..... H-5526 Hydraulic Oil Filter..... HC-5504 Oil Filter Full Flow..... C-5516		Hydraulic Oil Filter..... H-55280 Hydraulic Oil Filter..... HC-5504	
844 (DOZERS) S/N: 2KZ1-UP Air Filter Secondary..... A-5556 Air Filter Set..... A-5555-S Air Filter Primary..... A-5555 Fuel/Water Separator Secondary.. SFC-5504-10B Fuel/Water Separator Secondary.. SFC-5504-10 Hydraulic Oil Filter..... H-5506 Hydraulic Oil Filter..... H-5526		844H (DOZERS) CAT C27TA ACERT Cabin Air Filter..... CA-55120		854K (DOZERS) CAT C32TA ACERT Cabin Air Filter..... CA-55120	
844 (DOZERS) S/N: BBN1-UP Air Filter Primary..... A-5555 Air Filter Set..... A-5555-S Air Filter Secondary..... A-5556 Fuel/Water Separator Secondary.. SFC-5504-10 Fuel/Water Separator Secondary.. SFC-5504-10B Hydraulic Oil Filter..... H-5526 Hydraulic Oil Filter..... H-55280 Hydraulic Oil Filter..... H-5506		844K (DOZERS) CAT C27 Fuel/Water Separator..... SFC-55250		85C (TRACTORS) CAT 3176 Hydraulic Oil Filter..... H-5507	
844H (DOZERS) CAT S/N: BTW1-UP Air Filter Secondary..... A-5556 Air Filter Set..... A-5555-S Air Filter Primary..... A-5555 Fuel Filter..... FC-5510 Hydraulic Oil Filter..... H-55280 Hydraulic Oil Filter..... HC-5504 Hydraulic Oil Filter..... H-5526 Hydraulic Oil Filter..... H-5506 Oil Filter Full Flow..... C-5516		854G (DOZERS) CAT (S/N: 2GR1-2632-UP) Air Filter Secondary..... A-5715 Air Filter Primary..... A-44220 Air Filter Secondary..... A-44230 Air Filter Set..... A-44240-S Air Filter Secondary..... A-5594 Air Filter Set..... A-5595-S Air Filter Primary..... A-5593 Fuel Filter..... FC-5510		85D (TRACTORS) CAT S/N: 4GR1-UP Air Filter Primary..... A-5555 Air Filter Set..... A-5555-S Air Filter Secondary..... A-5556 Fuel Filter..... FC-5517 Fuel Filter..... FC-5509 Fuel/Water Separator Secondary.. SFC-5504-10 Fuel/Water Separator Secondary.. SFC-5504-10B Hydraulic Oil Filter..... HC-5512 Hydraulic Oil Filter..... HC-5506 Hydraulic Oil Filter..... HC-5503 Oil Filter Full Flow..... C-5516	
844H (DOZERS) CAT S/N: EHX1-2415-UP Air Filter Primary..... A-5555 Air Filter Set..... A-5555-S Air Filter Secondary..... A-5556 Fuel Filter..... FC-5510 Hydraulic Oil Filter..... H-5506 Hydraulic Oil Filter..... H-5526 Hydraulic Oil Filter..... HC-5504 Hydraulic Oil Filter..... H-55280 Oil Filter Full Flow..... C-5516		854G (DOZERS) CAT (S/N: 2GR2633-UP) Air Filter Primary..... A-5593 Air Filter Set..... A-5595-S Air Filter Secondary..... A-5594 Air Filter Set..... A-44240-S Air Filter Secondary..... A-44230 Air Filter Primary..... A-44220 Air Filter Secondary..... A-5715 Fuel Filter..... FC-5510		85D (TRACTORS) CAT S/N: 6AR1-UP Air Filter Secondary..... A-5556 Air Filter Set..... A-5555-S Air Filter Primary..... A-5555 Fuel Filter..... FC-5509 Fuel Filter..... FC-5517 Fuel/Water Separator Secondary.. SFC-5504-10B Fuel/Water Separator Secondary.. SFC-5504-10 Hydraulic Oil Filter..... HC-5503 Hydraulic Oil Filter..... HC-5506 Hydraulic Oil Filter..... HC-5512 Oil Filter Full Flow..... C-5516	
844H (DOZERS) CAT S/N: EHX2416-2486-UP Air Filter Secondary..... A-5556 Air Filter Set..... A-5555-S Air Filter Primary..... A-5555 Fuel Filter..... FC-5510 Hydraulic Oil Filter..... H-55280 Hydraulic Oil Filter..... HC-5504 Hydraulic Oil Filter..... H-5526 Hydraulic Oil Filter..... H-5506		854G (DOZERS) CAT 3508TA Cabin Air Filter..... CA-55120		85E (TRACTORS) CAT 3196 Hydraulic Oil Filter..... H-5507	
844H (DOZERS) CAT S/N: EHX2487-UP Air Filter Primary..... A-5555 Air Filter Set..... A-5555-S		854G (DOZERS) S/N: 1JW1-237-UP Hydraulic Oil Filter..... H-55280 Hydraulic Oil Filter..... HC-5512 Hydraulic Oil Filter..... H-5526		85E (TRACTORS) CAT S/N: 6AR1190-2131-UP Fuel Filter..... FC-5517 Oil Filter Full Flow..... C-5516	
		854G (DOZERS) S/N: 1JW238-UP Hydraulic Oil Filter..... H-5526 Hydraulic Oil Filter..... HC-5512 Hydraulic Oil Filter..... H-55280 Hydraulic Oil Filter..... HC-5504		85E (TRACTORS) CAT S/N: 6AR2132-2142-UP Fuel Filter..... FC-5517 Oil Filter Full Flow..... C-5516	
		854G (DOZERS) S/N: A4W1-UP Hydraulic Oil Filter..... HC-5504 Hydraulic Oil Filter..... H-55280 Hydraulic Oil Filter..... HC-5512 Hydraulic Oil Filter..... H-5526		85E (TRACTORS) CAT S/N: 6AR2143-2645-UP Fuel Filter..... FC-5517 Oil Filter Full Flow..... C-5516	
		854G (DOZERS) S/N: AMP1-UP Hydraulic Oil Filter..... H-5526 Hydraulic Oil Filter..... HC-5512		85E (TRACTORS) CAT S/N: 6AR2646-UP Fuel Filter..... FC-5517 Oil Filter Full Flow..... C-5516	
				85E (TRACTORS) CAT S/N: 6AR850-1189-UP Fuel Filter..... FC-5517 Oil Filter Full Flow..... C-5516	

MODEL/APPLICATION	SAKURA NO
CATERPILLAR	
85E (TRACTORS) S/N: 1N1M1-UP	
Air Filter Primary.....	A-5555
Air Filter Secondary.....	A-5556
Air Filter Set.....	A-5555-S
Fuel/Water Separator Secondary..	SFC-5504-10B
Fuel/Water Separator Secondary..	SFC-5504-10
Hydraulic Oil Filter.....	HC-5503
Hydraulic Oil Filter.....	HC-5506
Hydraulic Oil Filter.....	HC-5512
85E (TRACTORS) S/N: 15M1-UP	
Air Filter Set.....	A-5555-S
Air Filter Secondary.....	A-5556
Air Filter Primary.....	A-5555
Fuel/Water Separator Secondary..	SFC-5504-10
Fuel/Water Separator Secondary..	SFC-5504-10B
Hydraulic Oil Filter.....	HC-5512
Hydraulic Oil Filter.....	HC-5506
Hydraulic Oil Filter.....	HC-5503
85E (TRACTORS) S/N: 6J51-UP	
Air Filter Primary.....	A-5555
Air Filter Secondary.....	A-5556
Air Filter Set.....	A-5555-S
Fuel/Water Separator Secondary..	SFC-5504-10B
Fuel/Water Separator Secondary..	SFC-5504-10
Hydraulic Oil Filter.....	HC-5503
Hydraulic Oil Filter.....	HC-5506
Hydraulic Oil Filter.....	HC-5512
85E (TRACTORS) S/N: 6K51-UP	
Air Filter Set.....	A-5555-S
Air Filter Secondary.....	A-5556
Air Filter Primary.....	A-5555
Fuel/Water Separator Secondary..	SFC-5504-10
Fuel/Water Separator Secondary..	SFC-5504-10B
Hydraulic Oil Filter.....	HC-5512
Hydraulic Oil Filter.....	HC-5506
Hydraulic Oil Filter.....	HC-5503
902 (LOADERS) CAT 3024 (S/N: 7E51-UP)	
Air Filter Secondary.....	A-8599
Air Filter Primary.....	A-8505
Hydraulic Oil Filter.....	HC-5504
Oil Filter Full Flow.....	C-5504
Oil Filter Full Flow.....	C-1906
906 (LOADERS) CAT (S/N: 3NW30383-UP)	
Oil Filter Full Flow.....	C-5101
906 (LOADERS) CAT (S/N: CJS1-UP)	
Oil Filter Full Flow.....	C-5504
906 (LOADERS) CAT 3044C (S/N: 6Z51-UP)	
Air Filter Primary.....	A-8505
Air Filter Secondary.....	A-8599

MODEL/APPLICATION	SAKURA NO
CATERPILLAR	
Hydraulic Oil Filter.....	HC-5504
Oil Filter Full Flow.....	C-5504
906 (LOADERS) S/N: MER1-UP	
Air Filter Set.....	A-5541M-S
Air Filter Secondary.....	A-5540
Air Filter Primary.....	A-5541M
Air Filter Primary.....	A-5541
Air Filter Primary.....	A-76231
Hydraulic Oil Filter.....	HC-5504
906H (LOADERS) CAT 3044C , 2007-UP	
Air Filter Primary.....	A-5541
Air Filter Primary.....	A-5541M
Air Filter Secondary.....	A-5540
Air Filter Set.....	A-5541M-S
Air Filter Primary.....	A-76231
Hydraulic Oil Filter.....	HC-5504
908 (LOADERS) CAT (S/N: 7B31-UP)	
Air Filter Set.....	A-5675-S
Air Filter Primary.....	A-5673
Air Filter Secondary.....	A-8670
Oil Filter Full Flow.....	C-5101
Oil Filter Full Flow.....	C-5102
908 (LOADERS) CAT (S/N: CJS1-UP)	
Oil Filter Full Flow.....	C-5504
908 (LOADERS) CAT 3044C (S/N: 8B51-UP)	
Air Filter Primary.....	A-5541M
Air Filter Primary.....	A-5541
Air Filter Primary.....	A-76231
Air Filter Secondary.....	A-5540
Air Filter Set.....	A-5541M-S
Hydraulic Oil Filter.....	HC-5504
Oil Filter Full Flow.....	C-5102
908 (LOADERS) CAT 7B31-UP	
Air Filter Secondary.....	A-56741
Air Filter Set.....	A-56731-S
Air Filter Primary.....	A-56731
908 (LOADERS) S/N: TAR1-UP	
Air Filter Primary.....	A-76231
Air Filter Secondary.....	A-5540
Air Filter Set.....	A-5541M-S
Air Filter Primary.....	A-5541
Air Filter Primary.....	A-5541M
Hydraulic Oil Filter.....	HC-5504
910 (LOADERS) S/N: 40Y1-UP	
Air Filter Set.....	A-5542-S
Air Filter Secondary.....	A-5525
Air Filter Primary.....	A-5542
Fuel Filter.....	FC-5503
Hydraulic Oil Filter.....	H-5504
Oil Filter Full Flow.....	C-5504
910 (LOADERS) S/N: 1YK1-1999	
Oil Filter Full Flow.....	C-5505
910F (LOADERS) CAT 3114T (S/N: 1KF-UP)	
Air Filter Secondary.....	A-5525
Air Filter Set.....	A-5542-S
Air Filter Primary.....	A-5542
Air Filter Set.....	A-5663-S
Air Filter Primary.....	A-5627
Air Filter Secondary.....	A-6008

MODEL/APPLICATION	SAKURA NO
CATERPILLAR	
910 (LOADERS) S/N: 41Y1-UP	
Air Filter Primary.....	A-5542
Air Filter Secondary.....	A-5525
Air Filter Set.....	A-5542-S
Fuel Filter.....	FC-5503
Fuel Filter Secondary.....	FC-5507
Hydraulic Oil Filter.....	H-5504
Oil Filter Full Flow.....	C-5519
910 (LOADERS) S/N: 45Y22861-33060	
Air Filter Set.....	A-5542-S
Air Filter Secondary.....	A-5525
Air Filter Primary.....	A-5542
Fuel Filter.....	FC-5503
Hydraulic Oil Filter.....	H-5504
Oil Filter Full Flow.....	C-5519
Oil Filter Full Flow.....	C-5504
910 (LOADERS) S/N: 45Y33061-UP	
Air Filter Primary.....	A-5542
Air Filter Secondary.....	A-5525
Air Filter Set.....	A-5542-S
Fuel Filter.....	FC-5503
Hydraulic Oil Filter.....	H-5504
Oil Filter Full Flow.....	C-5519
Oil Filter Full Flow.....	C-5504
910 (LOADERS) S/N: 80U1-UP	
Air Filter Set.....	A-5542-S
Air Filter Secondary.....	A-5525
Air Filter Primary.....	A-5542
Fuel Filter.....	FC-5503
Hydraulic Oil Filter.....	H-5504
Oil Filter Full Flow.....	C-5519
Oil Filter Full Flow.....	C-5504
910 (LOADERS) w/3204 Eng.	
Air Filter Secondary.....	A-5590
910E (LOADERS) S/N: 1SF1-1103	
Air Filter Set.....	A-5511-S
Air Filter Primary.....	A-5511
Fuel Filter.....	F-5505
Fuel Filter Secondary.....	FC-5507
Hydraulic Oil Filter.....	H-5510
Oil Filter Full Flow.....	C-5505
910E (LOADERS) S/N: 1YK1-1999	
Oil Filter Full Flow.....	C-5505
910F (LOADERS) CAT 3114T (S/N: 1KF-UP)	
Air Filter Secondary.....	A-5525
Air Filter Set.....	A-5542-S
Air Filter Primary.....	A-5542
Air Filter Set.....	A-5663-S
Air Filter Primary.....	A-5627
Air Filter Secondary.....	A-6008

MODEL/APPLICATION	SAKURA NO
CATERPILLAR	
910F (LOADERS) CAT 3114T (S/N: 1KF-UP)	
Fuel Filter.....	F-5505
Fuel Filter.....	FC-5501
Fuel Filter.....	FC-5516
Fuel Filter Secondary.....	FC-55151
Fuel Filter Secondary.....	FC-5515
Hydraulic Oil Filter.....	H-5504
Oil Filter Full Flow.....	C-5505
910F (LOADERS) CAT 3114T (S/N: 1SF-UP)	
Air Filter Secondary.....	A-6008
Air Filter Primary.....	A-5627
Air Filter Set.....	A-5663-S
Air Filter Primary.....	A-5542
Air Filter Set.....	A-5542-S
Air Filter Secondary.....	A-5525
Fuel Filter Secondary.....	FC-5515
Fuel Filter Secondary.....	FC-55151
Fuel Filter.....	FC-5516
Fuel Filter.....	FC-5501
Fuel Filter.....	F-5505
Hydraulic Oil Filter.....	H-5504
Oil Filter Full Flow.....	C-5505
910F (LOADERS) S/N: 1KF1171-UP	
Fuel Filter Secondary.....	FC-5515
Fuel Filter.....	FC-5516
Fuel Filter Secondary.....	FC-55151
Oil Filter Full Flow.....	C-5505
910F (LOADERS) S/N: 1SF1100-UP	
Oil Filter Full Flow.....	C-5505
910F (LOADERS) S/N: 1SF1104-UP	
Air Filter Set.....	A-5663-S
Air Filter Primary.....	A-5627
Air Filter Secondary.....	A-6008
Fuel Filter Secondary.....	FC-5515
Fuel Filter.....	F-5505
Fuel Filter Secondary.....	FC-55151
Fuel Filter.....	FC-5516
Hydraulic Oil Filter.....	HC-5504
Hydraulic Oil Filter.....	H-5510
Oil Filter Full Flow.....	C-5505
910F (LOADERS) S/N: 1YK2000-UP	
Fuel Filter.....	FC-5516
Fuel Filter Secondary.....	FC-55151
Fuel Filter Secondary.....	FC-5515
Oil Filter Full Flow.....	C-5505
910G (LOADERS) S/N: AKR1-UP	
Air Filter Set.....	A-5541M-S
Air Filter Primary.....	A-5541
Air Filter Primary.....	A-5541M
Air Filter Primary.....	A-76231
Hydraulic Oil Filter.....	HC-5504

MODEL/APPLICATION	SAKURA NO
CATERPILLAR	
914 (LOADERS) PERKINS	
Air Filter Primary.....	A-5627
Air Filter Set.....	A-5663-S
Hydraulic Oil Filter.....	HC-5504
Oil Filter Full Flow.....	C-5102
914G (LOADERS) CAT 7BJ1-UP , 2011	
Air Filter Set.....	A-56731-S
Air Filter Secondary.....	A-56741
Air Filter Primary.....	A-56731
914G (LOADERS) S/N: 7ZM440-653-UP , 2001-2014	
Air Filter Primary.....	A-5627
Air Filter Primary.....	A-76231
Air Filter Set.....	A-5541M-S
Air Filter Set.....	A-5663-S
Air Filter Primary.....	A-5541M
Air Filter Primary.....	A-5541
Air Filter Secondary.....	A-5540
Hydraulic Oil Filter.....	HC-5504
914G (LOADERS) CAT (S/N: 5HK11200-11200-UP)	
Oil Filter Full Flow.....	C-5102
914G (LOADERS) CAT (S/N: 5HK11201-UP)	
Oil Filter Full Flow.....	C-5102
914G (LOADERS) CAT (S/N: 7BJ1-UP)	
Air Filter Set.....	A-5675-S
Air Filter Primary.....	A-5673
Air Filter Secondary.....	A-8670
Oil Filter Full Flow.....	C-5102
Oil Filter Full Flow.....	C-5101
914G (LOADERS) CAT (S/N: CRS1-UP)	
Oil Filter Full Flow.....	C-5102
914G (LOADERS) CAT 3054C DIT (S/N: 7ZM1-UP)	
Air Filter Primary.....	A-76231
Air Filter Primary.....	A-5627
Air Filter Set.....	A-5541M-S
Air Filter Set.....	A-5663-S
Air Filter Primary.....	A-5541M
Air Filter Primary.....	A-5541
Air Filter Secondary.....	A-5540
Hydraulic Oil Filter.....	HC-5504
Oil Filter Full Flow.....	C-5102
914G (LOADERS) CAT 3054C DIT (S/N: 9WM1-UP)	
Air Filter Secondary.....	A-5540
Air Filter Primary.....	A-5541
Air Filter Primary.....	A-5541M
Air Filter Set.....	A-5663-S
Air Filter Set.....	A-5541M-S
Air Filter Primary.....	A-5627
Air Filter Primary.....	A-76231

MODEL/APPLICATION	SAKURA NO
CATERPILLAR	
Hydraulic Oil Filter.....	HC-5504
Oil Filter Full Flow.....	C-5102
914G (LOADERS) S/N: 7ZM225-439-UP	
Air Filter Primary.....	A-5627
Air Filter Set.....	A-5663-S
Hydraulic Oil Filter.....	HC-5504
914G (LOADERS) S/N: 7ZM654-UP	
Air Filter Secondary.....	A-5540
Air Filter Primary.....	A-5541M
Air Filter Primary.....	A-5541
Air Filter Primary.....	A-5627
Air Filter Set.....	A-5663-S
Air Filter Set.....	A-5541M-S
Air Filter Primary.....	A-76231
Hydraulic Oil Filter.....	HC-5504
914G (LOADERS) S/N: 9WM363-1012-UP	
Air Filter Set.....	A-5663-S
Air Filter Primary.....	A-5627
Hydraulic Oil Filter.....	HC-5504
914G (LOADERS) S/N: PDF1-UP	
Air Filter Primary.....	A-5541
Air Filter Primary.....	A-5541M
Air Filter Secondary.....	A-5540
Air Filter Set.....	A-5541M-S
Air Filter Primary.....	A-76231
Hydraulic Oil Filter.....	HC-5504
916 (LOADERS) CAT (S/N: 45V42589-UP)	
Fuel Filter.....	FC-5501
Oil Filter Full Flow.....	C-5505
916 (LOADERS) CAT 3204 (S/N: 2XB1-UP)	
Air Filter.....	A-5530
Air Filter Set.....	A-55071-S
Air Filter Set.....	A-5507-S
Air Filter Primary.....	A-5507
Fuel Filter Secondary.....	FC-5507
Fuel Filter.....	F-5505
Hydraulic Oil Filter.....	H-5506
Oil Filter Full Flow.....	C-5505
916 (LOADERS) CAT 3204 (S/N: 5KC1-UP)	
Air Filter Primary.....	A-5507
Air Filter Set.....	A-5507-S
Air Filter Set.....	A-55071-S
Air Filter.....	A-5530
Fuel Filter.....	F-5505
Fuel Filter Secondary.....	FC-5507
Hydraulic Oil Filter.....	H-5506
Oil Filter Full Flow.....	C-5505
916 (LOADERS) CAT 3204 (S/N: 9WB1-UP)	
Air Filter.....	A-5530
Air Filter Set.....	A-55071-S

Sakura Filter

ENGINE APPLICATION

MODEL/APPLICATION	SAKURA NO
CATERPILLAR	
916 (LOADERS) CAT 3204 (S/N: 9WB1-UP)	
Air Filter Set.....	A-5507-S
Air Filter Primary.....	A-5507
Fuel Filter Secondary.....	FC-5507
Fuel Filter.....	F-5505
Hydraulic Oil Filter.....	H-5506
Oil Filter Full Flow.....	C-5505
916 (LOADERS) S/N: 9WB2005-UP	
Air Filter Primary.....	A-5507
Air Filter Set.....	A-5507-S
Air Filter Set.....	A-55071-S
Air Filter.....	A-5530
Fuel Filter.....	F-5505
Fuel Filter Secondary.....	FC-5507
Hydraulic Oil Filter.....	H-5506
Oil Filter Full Flow.....	C-5505
918F (LOADERS) CAT (S/N: 2FG4905-UP)	
Fuel Filter Secondary.....	FC-5507
Fuel Filter Secondary.....	FC-5515
Fuel Filter Secondary.....	FC-55151
Fuel Filter.....	FC-5516
Oil Filter Full Flow.....	C-5505
918F (LOADERS) CAT S/N: 2FG1500-4904-UP	
Fuel Filter Secondary.....	FC-5507
Oil Filter Full Flow.....	C-5505
918F (LOADERS) CAT S/N: 97Z152-UP	
Fuel Filter Secondary.....	FC-5507
Oil Filter Full Flow.....	C-5505
918F (LOADERS) S/N: 2CK1-UP	
Air Filter Set.....	A-5568-S
Air Filter Primary.....	A-5566
Air Filter Secondary.....	A-5567
Fuel Filter.....	F-5505
Fuel Filter Secondary.....	FC-5507
Hydraulic Oil Filter.....	HC-5504
Hydraulic Oil Filter.....	H-5506
Oil Filter Full Flow.....	C-5505
918F (LOADERS) S/N: 3TJ1-UP	
Air Filter Secondary.....	A-5567
Air Filter Primary.....	A-5566
Air Filter Set.....	A-5568-S
Fuel Filter.....	F-5505
Fuel Filter Secondary.....	FC-5515
Fuel Filter.....	FC-5516
Fuel Filter Secondary.....	FC-55151
Hydraulic Oil Filter.....	HC-5504
Hydraulic Oil Filter.....	H-5506
Oil Filter Full Flow.....	C-5505
918F (LOADERS) S/N: 5DL1-UP	

MODEL/APPLICATION	SAKURA NO
CATERPILLAR	
Air Filter Set.....	A-5568-S
Air Filter Primary.....	A-5566
Air Filter Secondary.....	A-5567
Fuel Filter.....	F-5505
Fuel Filter Secondary.....	FC-5507
Hydraulic Oil Filter.....	HC-5504
Hydraulic Oil Filter.....	H-5506
Oil Filter Full Flow.....	C-5505
920 (LOADERS)	
Air Filter Primary.....	A-44180
Air Filter Set.....	A-44180-S
920 (LOADERS) S/N: 62K11414-UP	
Air Filter Primary.....	A-5507
Air Filter Secondary.....	A-5567
Air Filter Secondary.....	A-5508
Air Filter Set.....	A-55071-S
Air Filter Set.....	A-5507-S
Air Filter Primary.....	A-5566
Air Filter Set.....	A-5568-S
Fuel Filter Secondary.....	FC-5507
Hydraulic Oil Filter.....	H-5504
Oil Filter Full Flow.....	C-5510
920 (LOADERS) S/N: 62K1-3389	
Air Filter Primary.....	A-5507
Air Filter Set.....	A-5568-S
Air Filter Primary.....	A-5566
Air Filter Set.....	A-5507-S
Air Filter Set.....	A-55071-S
Air Filter Secondary.....	A-5508
Air Filter Secondary.....	A-5567
Fuel Filter Secondary.....	FC-5507
Hydraulic Oil Filter.....	H-5504
Hydraulic Oil Filter.....	H-5503
Oil Filter Full Flow.....	O-5502
920 (LOADERS) S/N: 62K3390-11413	
Air Filter Primary.....	A-5507
Air Filter Secondary.....	A-5567
Air Filter Secondary.....	A-5508
Air Filter Set.....	A-55071-S
Air Filter Set.....	A-5507-S
Air Filter Primary.....	A-5566
Air Filter Set.....	A-5568-S
Fuel Filter Secondary.....	FC-5507
Hydraulic Oil Filter.....	H-5503
Hydraulic Oil Filter.....	H-5504
Oil Filter Full Flow.....	C-5510
920 (LOADERS) S/N: 62K3394	
Air Filter Set.....	A-5568-S
Air Filter Primary.....	A-5566
Air Filter Set.....	A-5507-S
Air Filter Set.....	A-55071-S
Air Filter Secondary.....	A-5508
Air Filter Secondary.....	A-5567
Air Filter Primary.....	A-5507

MODEL/APPLICATION	SAKURA NO
CATERPILLAR	
Fuel Filter Secondary.....	FC-5507
Hydraulic Oil Filter.....	H-5504
Hydraulic Oil Filter.....	H-5503
Oil Filter Full Flow.....	C-5510
920 (LOADERS) S/N: 62K3394-62K3394	
Air Filter Secondary.....	A-5567
Air Filter Secondary.....	A-5508
Air Filter Set.....	A-55071-S
Air Filter Set.....	A-5507-S
Air Filter Primary.....	A-5566
Air Filter Set.....	A-5568-S
Air Filter Primary.....	A-5507
Fuel Filter Secondary.....	FC-5507
Hydraulic Oil Filter.....	H-5503
Hydraulic Oil Filter.....	H-5504
Oil Filter Full Flow.....	O-5502
920 (LOADERS) S/N: 75J1-UP	
Air Filter Set.....	A-5507-S
Air Filter Set.....	A-55071-S
Air Filter Secondary.....	A-5508
Air Filter Primary.....	A-5507
Fuel Filter Secondary.....	FC-5507
Hydraulic Oil Filter.....	H-5504
Hydraulic Oil Filter.....	H-5503
Oil Filter Full Flow.....	C-5510
Oil Filter Full Flow.....	O-5502
920 (LOADERS) w/3304 Eng.	
Hydraulic Oil Filter.....	H-55320
922A (LOADERS)	
Air Filter Primary.....	A-5511
Air Filter Set.....	A-5511-S
Air Filter Secondary.....	A-5512
Air Filter Secondary.....	A-5508
Air Filter Set.....	A-55071-S
Air Filter Set.....	A-5507-S
Air Filter Primary.....	A-5507
Air Filter Set.....	A-5568-S
Air Filter Primary.....	A-5566
Air Filter Secondary.....	A-5567
Fuel Filter.....	F-5505
Fuel Filter Secondary.....	FC-5507
Hydraulic Oil Filter.....	H-5503
Oil Filter Full Flow.....	O-5502
922B (LOADERS) S/N: 59A1-UP	
Air Filter Secondary.....	A-5512
Air Filter Set.....	A-5511-S
Air Filter Primary.....	A-5511
Fuel Filter.....	F-5501
Hydraulic Oil Filter.....	H-5503
Oil Filter Full Flow.....	O-5502
922B (LOADERS) S/N: 88J1-UP	
Air Filter Primary.....	A-5507
Air Filter Set.....	A-5507-S

MODEL/APPLICATION	SAKURA NO
CATERPILLAR	
922B (LOADERS) S/N: 8831-UP	
Air Filter Set.....	A-55071-S
Air Filter Secondary.....	A-5508
Air Filter Secondary.....	A-5567
Air Filter Primary.....	A-5566
Air Filter Set.....	A-5568-S
Fuel Filter Secondary.....	FC-5507
Hydraulic Oil Filter.....	H-5503
Oil Filter Full Flow.....	O-5502
922B (LOADERS) S/N: 94A1-UP	
Air Filter Primary.....	A-5511
Air Filter Set.....	A-5511-S
Air Filter Secondary.....	A-5512
Fuel Filter.....	F-5501
Hydraulic Oil Filter.....	H-5503
Oil Filter Full Flow.....	O-5502
922C (LOADERS) CAT (S/N: 73W1-UP)	
Fuel Filter.....	FC-5509
922C (LOADERS) S/N: 49Z1-UP	
Air Filter Primary.....	A-5521
Air Filter Set.....	A-5521-S
Air Filter Secondary.....	A-5529
Fuel Filter.....	FC-5509
Hydraulic Oil Filter.....	H-5504
Hydraulic Oil Filter.....	H-5509
Hydraulic Oil Filter.....	H-5508
Hydraulic Oil Filter.....	H-5502
Hydraulic Oil Filter.....	H-55280
Hydraulic Oil Filter.....	H-55270
Oil Filter Full Flow.....	C-5516
922 (LOADERS) S/N: 63A-UP	
Air Filter Primary.....	A-5511
Air Filter Set.....	A-5511-S
Air Filter Secondary.....	A-5512
Hydraulic Oil Filter.....	H-5503
Oil Filter Full Flow.....	O-5501
924F (LOADERS) CAT (S/N: 2FG6235-UP)	
Fuel Filter.....	FC-5516
Fuel Filter Secondary.....	FC-55151
Fuel Filter Secondary.....	FC-5515
Oil Filter Full Flow.....	C-5522
924F (LOADERS) CAT (S/N: 4RR1-689-UP)	
Fuel Filter Secondary.....	FC-5515
Fuel Filter Secondary.....	FC-55151
Fuel Filter.....	FC-5516
Oil Filter Full Flow.....	C-5522
Oil Filter Full Flow.....	C-5505
924F (LOADERS) CAT (S/N: 4RR690-UP)	
Fuel Filter.....	FC-5516

MODEL/APPLICATION	SAKURA NO
CATERPILLAR	
Fuel Filter Secondary.....	FC-55151
Fuel Filter Secondary.....	FC-5515
Oil Filter Full Flow.....	C-5505
Oil Filter Full Flow.....	C-5522
924F (LOADERS) CAT (S/N: 97Z1-1449-UP)	
Fuel Filter Secondary.....	FC-5507
Oil Filter Full Flow.....	C-5522
Oil Filter Full Flow.....	C-5505
924F (LOADERS) CAT (S/N: 97Z1450-3227-UP)	
Fuel Filter Secondary.....	FC-5507
Fuel Filter Secondary.....	FC-5515
Fuel Filter Secondary.....	FC-55151
Fuel Filter.....	FC-5516
Oil Filter Full Flow.....	C-5505
Oil Filter Full Flow.....	C-5522
924F (LOADERS) CAT (S/N: 97Z3228-5312-UP)	
Fuel Filter.....	FC-5516
Fuel Filter Secondary.....	FC-55151
Fuel Filter Secondary.....	FC-5515
Fuel Filter Secondary.....	FC-5507
Oil Filter Full Flow.....	C-5522
Oil Filter Full Flow.....	C-5505
924F (LOADERS) CAT (S/N: 97Z5313-UP)	
Fuel Filter Secondary.....	FC-5507
Fuel Filter Secondary.....	FC-5515
Fuel Filter Secondary.....	FC-55151
Fuel Filter.....	FC-5516
Oil Filter Full Flow.....	C-5505
Oil Filter Full Flow.....	C-5522
924F (LOADERS) S/N: 4YN1463-1533-UP	
Air Filter Set.....	A-5568-S
Air Filter Primary.....	A-5566
Air Filter Secondary.....	A-5567
Cabin Air Filter.....	CA-55070
Hydraulic Oil Filter.....	HC-5504
Hydraulic Oil Filter.....	H-5506
924F (LOADERS) S/N: 4YN1-482-UP	
Air Filter Secondary.....	A-5567
Air Filter Primary.....	A-5566
Air Filter Set.....	A-5568-S
Cabin Air Filter.....	CA-55070
Hydraulic Oil Filter.....	H-5506
Hydraulic Oil Filter.....	HC-5508
924F (LOADERS) S/N: 4YN1534-UP	
Air Filter Set.....	A-5568-S
Air Filter Primary.....	A-5566
Air Filter Secondary.....	A-5567
Cabin Air Filter.....	CA-55070
Hydraulic Oil Filter.....	HC-5504
Hydraulic Oil Filter.....	H-5506

MODEL/APPLICATION	SAKURA NO
CATERPILLAR	
924F (LOADERS) S/N: 4YN1-UP	
Air Filter Secondary.....	A-5567
Air Filter Primary.....	A-5566
Air Filter Set.....	A-5568-S
Fuel Filter.....	F-5505
Fuel Filter Secondary.....	FC-5515
Fuel Filter.....	FC-5516
Fuel Filter Secondary.....	FC-55151
Hydraulic Oil Filter.....	HC-5504
Hydraulic Oil Filter.....	H-5506
Oil Filter Full Flow.....	C-5505
Oil Filter Full Flow.....	C-5510
924F (LOADERS) S/N: 4YN483-1462-UP	
Air Filter Set.....	A-5568-S
Air Filter Primary.....	A-5566
Air Filter Secondary.....	A-5567
Hydraulic Oil Filter.....	HC-5504
Hydraulic Oil Filter.....	H-5506
924F (LOADERS) S/N: 5NN1-UP	
Air Filter Primary.....	A-5566
Air Filter Set.....	A-5568-S
Air Filter Secondary.....	A-5567
Cabin Air Filter.....	CA-55070
Fuel Filter.....	F-5505
Fuel Filter Secondary.....	FC-5515
Fuel Filter Secondary.....	FC-55151
Fuel Filter.....	FC-5516
Hydraulic Oil Filter.....	HC-5504
Hydraulic Oil Filter.....	H-5506
Oil Filter Full Flow.....	C-5505
Oil Filter Full Flow.....	C-5510
924F (LOADERS) S/N: 6MN1-457-UP	
Air Filter Set.....	A-5568-S
Air Filter Primary.....	A-5566
Air Filter Secondary.....	A-5567
Cabin Air Filter.....	CA-55070
Hydraulic Oil Filter.....	HC-5508
Hydraulic Oil Filter.....	H-5506
924F (LOADERS) S/N: 6MN1-UP	
Air Filter Secondary.....	A-5567
Air Filter Primary.....	A-5566
Air Filter Set.....	A-5568-S
Fuel Filter Secondary.....	FC-5515
Fuel Filter.....	FC-5516
Fuel Filter Secondary.....	FC-55151
Hydraulic Oil Filter.....	HC-5504
Hydraulic Oil Filter.....	H-5506
Oil Filter Full Flow.....	C-5505
924F (LOADERS) S/N: 6MN458-UP	
Air Filter Set.....	A-5568-S
Air Filter Primary.....	A-5566
Air Filter Secondary.....	A-5567

MODEL/APPLICATION	SAKURA NO	MODEL/APPLICATION	SAKURA NO	MODEL/APPLICATION	SAKURA NO
CATERPILLAR		CATERPILLAR		CATERPILLAR	
924F (LOADERS) S/N: 6MN458-UP		Air Filter Primary.....	AS-8577	Air Filter Primary.....	AS-8577
Cabin Air Filter.....	CA-55070	Air Filter Secondary.....	A-8578	Hydraulic Oil Filter.....	HC-5504
Hydraulic Oil Filter.....	HC-5504	Hydraulic Oil Filter.....	HC-5504		
Hydraulic Oil Filter.....	H-5506	Oil Filter Full Flow.....	C-5101	924G (LOADERS) S/N: RBB833-899-UP	
924F (LOADERS) S/N: 7PN1-UP		924G (LOADERS) CAT 3056E ATAAC (S/N: AAN1-UP)		Air Filter Primary.....	AS-8577
Air Filter Primary.....	A-5566	Air Filter Secondary.....	A-8578	Air Filter Primary.....	A-5105
Air Filter Set.....	A-5568-S	Air Filter Primary.....	AS-8577	Air Filter Secondary.....	A-8578
Air Filter Secondary.....	A-5567	Hydraulic Oil Filter.....	HC-5504	Air Filter Secondary.....	A-5106
Fuel Filter.....	F-5505	Oil Filter Full Flow.....	C-5101	Hydraulic Oil Filter.....	HC-5504
Fuel Filter Secondary.....	FC-5515	924G (LOADERS) S/N: 3PZ1-UP		924G (LOADERS) S/N: RBB900-1048-UP	
Fuel Filter Secondary.....	FC-55151	Air Filter Secondary.....	A-8578	Air Filter Secondary.....	A-8578
Fuel Filter.....	FC-5516	Air Filter Primary.....	AS-8577	Air Filter Primary.....	AS-8577
Hydraulic Oil Filter.....	HC-5504	Hydraulic Oil Filter.....	HC-5504	Hydraulic Oil Filter.....	HC-5504
Hydraulic Oil Filter.....	H-5506	924G (LOADERS) S/N: 9SW1-UP		924G (LOADERS) S/N: WMB1-UP	
Oil Filter Full Flow.....	C-5505	Air Filter Secondary.....	A-8578	Air Filter Secondary.....	A-8578
924G (LOADERS) CAT (S/N: 8XJ1-UP)		Air Filter Primary.....	AS-8577	Air Filter Secondary.....	A-5106
Oil Filter Full Flow.....	C-5101	Hydraulic Oil Filter.....	HC-5504	Air Filter Primary.....	AS-8577
924G (LOADERS) CAT (S/N: CPT1-UP)		924G (LOADERS) S/N: AAN1035-UP		Air Filter Primary.....	A-5105
Fuel Filter.....	FC-5517	Air Filter Secondary.....	A-8578	Hydraulic Oil Filter.....	HC-5504
Oil Filter Full Flow.....	C-5101	Air Filter Primary.....	AS-8577	924GZ (LOADERS) CAT (S/N: 8XJ1-UP)	
Oil Filter Full Flow.....	C-5522	Hydraulic Oil Filter.....	HC-5504	Oil Filter Full Flow.....	C-5101
924G (LOADERS) CAT 3056E ATAAC (S/N: 3DZ1-UP)		924G (LOADERS) S/N: AAN675-1034-UP		924GZ (LOADERS) CAT (S/N: CPT1-UP)	
Air Filter Secondary.....	A-8578	Air Filter Secondary.....	A-8578	Fuel Filter.....	FC-5517
Air Filter Primary.....	AS-8577	Air Filter Primary.....	AS-8577	Oil Filter Full Flow.....	C-5101
Hydraulic Oil Filter.....	HC-5504	Air Filter Secondary.....	A-8578	Oil Filter Full Flow.....	C-5522
Oil Filter Full Flow.....	C-5101	Hydraulic Oil Filter.....	HC-5504	924GZ (LOADERS) CAT 3056 (S/N: DFZ1-UP)	
924G (LOADERS) CAT 3056E ATAAC (S/N: 3PZ1-UP)		924G (LOADERS) S/N: DDA1-UP		Air Filter Secondary.....	A-8578
Air Filter Primary.....	AS-8577	Air Filter Primary.....	AS-8577	Air Filter Primary.....	AS-8577
Air Filter Secondary.....	A-8578	Air Filter Primary.....	AS-8577	Hydraulic Oil Filter.....	HC-5504
Hydraulic Oil Filter.....	HC-5504	Hydraulic Oil Filter.....	HC-5504	Oil Filter Full Flow.....	C-5510
Oil Filter Full Flow.....	C-5101	924G (LOADERS) S/N: EEB1-UP		924GZ (LOADERS) CAT 3056 (S/N: WGX1-UP)	
924G (LOADERS) CAT 3056E ATAAC (S/N: 6W1-UP)		Air Filter Secondary.....	A-8578	Air Filter Primary.....	AS-8577
Air Filter Secondary.....	A-8578	Air Filter Primary.....	A-5105	Air Filter Secondary.....	A-8578
Air Filter Primary.....	AS-8577	Air Filter Secondary.....	A-8578	Hydraulic Oil Filter.....	HC-5504
Hydraulic Oil Filter.....	HC-5504	Air Filter Secondary.....	A-5106	Oil Filter Full Flow.....	C-5510
Oil Filter Full Flow.....	C-5101	Hydraulic Oil Filter.....	HC-5504	924GZ (LOADERS) CAT 3056E ATAAC (S/N: AAB451-UP)	
924G (LOADERS) CAT 3056E ATAAC (S/N: 6YW1-UP)		924G (LOADERS) S/N: RBB1049-UP		Air Filter Secondary.....	A-8578
Air Filter Secondary.....	A-8578	Air Filter Primary.....	A-5105	Air Filter Primary.....	AS-8577
Air Filter Primary.....	AS-8577	Air Filter Primary.....	AS-8577	Hydraulic Oil Filter.....	HC-5504
Hydraulic Oil Filter.....	HC-5504	Air Filter Secondary.....	A-5106	924GZ (LOADERS) S/N: AAB1-319-UP	
Oil Filter Full Flow.....	C-5101	Air Filter Secondary.....	A-5106	Air Filter Primary.....	AS-8577
924G (LOADERS) CAT 3056E ATAAC (S/N: 9SW1-UP)		Air Filter Primary.....	A-5105	Air Filter Secondary.....	A-8578
Air Filter Secondary.....	A-8578	Air Filter Primary.....	AS-8577	Hydraulic Oil Filter.....	HC-5504
Air Filter Primary.....	AS-8577	Air Filter Secondary.....	A-8578	924GZ (LOADERS) S/N: AAB320-450-UP	
Hydraulic Oil Filter.....	HC-5504	Hydraulic Oil Filter.....	HC-5504	Air Filter Secondary.....	A-8578
Oil Filter Full Flow.....	C-5101	924G (LOADERS) S/N: RBB1-832-UP		Air Filter Primary.....	AS-8577
924G (LOADERS) CAT 3056E ATAAC (S/N: AAB1-UP)		Air Filter Secondary.....	A-8578	Hydraulic Oil Filter.....	HC-5504
Air Filter Secondary.....	A-8578				

MODEL/APPLICATION	SAKURA NO	MODEL/APPLICATION	SAKURA NO	MODEL/APPLICATION	SAKURA NO
CATERPILLAR		CATERPILLAR		CATERPILLAR	
924GZ (LOADERS) S/N: RTA1-390-UP Air Filter Primary..... AS-8577 Air Filter Secondary..... A-8578 Hydraulic Oil Filter..... HC-5504		Air Filter Set..... A-5507-S Air Filter Set..... A-55071-S Air Filter..... A-5530 Air Filter Primary..... A-5507 Hydraulic Oil Filter..... H-5501 Hydraulic Oil Filter..... H-5506		Air Filter..... A-5530 Hydraulic Oil Filter..... H-5501 Hydraulic Oil Filter..... H-5506	
924GZ (LOADERS) S/N: RTA391-461-UP Air Filter Secondary..... A-5106 Air Filter Primary..... A-5105 Air Filter Secondary..... A-8578 Air Filter Primary..... AS-8577 Hydraulic Oil Filter..... HC-5504		926 (LOADERS) S/N: 4NB-UP Air Filter Secondary..... A-5567 Air Filter Primary..... A-5566 Air Filter Set..... A-5568-S Air Filter Primary..... A-5507 Air Filter..... A-5530 Air Filter Set..... A-55071-S Air Filter Set..... A-5507-S Fuel Filter Secondary..... FC-5507 Fuel Filter..... FC-5501 Hydraulic Oil Filter..... H-5506 Oil Filter Full Flow..... C-5505		926 (LOADERS) S/N: 94Z1821-2050-UP Air Filter..... A-5530 Air Filter Primary..... A-5507 Air Filter Set..... A-5507-S Air Filter Set..... A-55071-S Hydraulic Oil Filter..... H-5506 Hydraulic Oil Filter..... H-5501	
924GZ (LOADERS) S/N: RTA462-496-UP Air Filter Primary..... AS-8577 Air Filter Secondary..... A-8578 Hydraulic Oil Filter..... HC-5504		926 (LOADERS) S/N: 7TC1-833 Air Filter Secondary..... A-5525 Air Filter Primary..... A-5542 Air Filter Set..... A-5542-S Fuel Filter..... FC-5503 Oil Filter Full Flow..... C-5505		926 (LOADERS) S/N: 94Z2051-UP Air Filter Set..... A-55071-S Air Filter Set..... A-5507-S Air Filter Primary..... A-5507 Air Filter..... A-5530 Hydraulic Oil Filter..... H-5501 Hydraulic Oil Filter..... H-5506	
924GZ (LOADERS) S/N: RTA497-UP Air Filter Primary..... A-5105 Air Filter Secondary..... A-5106 Air Filter Secondary..... A-8578 Air Filter Primary..... AS-8577 Hydraulic Oil Filter..... HC-5504		926 (LOADERS) S/N: 8NB1-UP Air Filter..... A-5530 Air Filter Primary..... A-5507 Air Filter Set..... A-5507-S Air Filter Set..... A-55071-S Fuel Filter Secondary..... FC-5507 Fuel Filter..... F-5505 Hydraulic Oil Filter..... H-5506 Oil Filter Full Flow..... C-5505		926E (LOADERS) CAT 3204 (S/N: 4NB1-3611-UP) Air Filter..... A-5530 Air Filter Primary..... A-5507 Air Filter Set..... A-5507-S Air Filter Set..... A-55071-S Fuel Filter..... F-5505 Fuel Filter Secondary..... FC-5507 Hydraulic Oil Filter..... H-5506 Oil Filter Full Flow..... C-5505 Oil Filter Full Flow..... C-5510	
926 (LOADERS) CAT (S/N: 45V39562-UP) Fuel Filter..... FC-5501 Oil Filter Full Flow..... C-5505		926 (LOADERS) S/N: 8NB1-UP Air Filter..... A-5530 Air Filter Primary..... A-5507 Air Filter Set..... A-5507-S Air Filter Set..... A-55071-S Fuel Filter Secondary..... FC-5507 Fuel Filter..... F-5505 Hydraulic Oil Filter..... H-5506 Oil Filter Full Flow..... C-5505		926E (LOADERS) CAT 3204 (S/N: 4NB3612-UP) Air Filter Set..... A-55071-S Air Filter Set..... A-5507-S Air Filter Primary..... A-5507 Air Filter..... A-5530 Fuel Filter Secondary..... FC-5507 Fuel Filter..... F-5505 Hydraulic Oil Filter..... H-5506 Oil Filter Full Flow..... C-5510 Oil Filter Full Flow..... C-5505	
926 (LOADERS) S/N: 4NB1026-1026-UP Hydraulic Oil Filter..... H-5501		926 (LOADERS) S/N: 94Z1-1716-UP Air Filter Set..... A-55071-S Air Filter Set..... A-5507-S Air Filter Primary..... A-5507 Air Filter..... A-5530 Hydraulic Oil Filter..... H-5501 Hydraulic Oil Filter..... H-5506		926E (LOADERS) CAT 3204 (S/N: 7TC1-UP) Air Filter..... A-5530 Air Filter Primary..... A-5507 Air Filter Set..... A-5507-S Air Filter Set..... A-55071-S Fuel Filter..... F-5505 Fuel Filter Secondary..... FC-5507 Hydraulic Oil Filter..... H-5506 Oil Filter Full Flow..... C-5510 Oil Filter Full Flow..... C-5505	
926 (LOADERS) S/N: 4NB1027-1027-UP Hydraulic Oil Filter..... H-5501		926 (LOADERS) S/N: 4NB1028-1588-UP Hydraulic Oil Filter..... H-5501		926E (LOADERS) CAT 3204 (S/N: 8NB1-1542-UP) Air Filter..... A-5530 Air Filter Primary..... A-5507 Air Filter Set..... A-5507-S Air Filter Set..... A-55071-S Fuel Filter..... F-5505 Fuel Filter Secondary..... FC-5507 Hydraulic Oil Filter..... H-5506 Oil Filter Full Flow..... C-5505 Oil Filter Full Flow..... C-5510	
926 (LOADERS) S/N: 4NB1589-1605-UP Hydraulic Oil Filter..... H-5501		926 (LOADERS) S/N: 4NB1606-1840-UP Hydraulic Oil Filter..... H-5501		926E (LOADERS) CAT 3204 (S/N: 94Z1717-1820-UP) Air Filter Set..... A-55071-S Air Filter Set..... A-5507-S Air Filter Primary..... A-5507 Air Filter Set..... A-5507-S Air Filter Set..... A-55071-S Fuel Filter..... F-5505 Fuel Filter Secondary..... FC-5507 Hydraulic Oil Filter..... H-5506 Oil Filter Full Flow..... C-5505	
926 (LOADERS) S/N: 4NB1841-3028-UP Air Filter Primary..... A-5507 Air Filter..... A-5530 Air Filter Set..... A-55071-S Air Filter Set..... A-5507-S Hydraulic Oil Filter..... H-5501		926 (LOADERS) S/N: 94Z1717-1820-UP Air Filter Set..... A-55071-S Air Filter Set..... A-5507-S Air Filter Primary..... A-5507 Air Filter Set..... A-5507-S Air Filter Set..... A-55071-S Fuel Filter..... F-5505 Fuel Filter Secondary..... FC-5507 Hydraulic Oil Filter..... H-5506 Oil Filter Full Flow..... C-5505		926E (LOADERS) CAT 3204 (S/N: 8NB1-1542-UP) Air Filter Set..... A-55071-S Air Filter Set..... A-5507-S Air Filter Primary..... A-5507 Air Filter..... A-5530	
926 (LOADERS) S/N: 4NB3029-UP		926 (LOADERS) S/N: 94Z1717-1820-UP Air Filter Set..... A-55071-S Air Filter Set..... A-5507-S Air Filter Primary..... A-5507			

MODEL/APPLICATION	SAKURA NO
CATERPILLAR	
926E (LOADERS) CAT 3204 (S/N: 8NB1-1542-UP)	
Fuel Filter Secondary.....	FC-5507
Fuel Filter.....	F-5505
Hydraulic Oil Filter.....	H-5506
Oil Filter Full Flow.....	C-5510
Oil Filter Full Flow.....	C-5505
926E (LOADERS) CAT 3204 (S/N: 8NB1543-UP)	
Air Filter.....	A-5530
Air Filter Primary.....	A-5507
Air Filter Set.....	A-5507-S
Air Filter Set.....	A-55071-S
Fuel Filter.....	F-5505
Fuel Filter Secondary.....	FC-5507
Hydraulic Oil Filter.....	H-5506
Oil Filter Full Flow.....	C-5505
Oil Filter Full Flow.....	C-5510
926E (LOADERS) S/N: 8NB2452-UP	
Air Filter.....	A-5530
Air Filter Set.....	A-55071-S
Air Filter Set.....	A-5507-S
Air Filter Primary.....	A-5507
Fuel Filter Secondary.....	FC-5507
Fuel Filter.....	F-5505
Oil Filter Full Flow.....	C-5505
928F (LOADERS) CAT S/N: 4TF14750-UP	
Fuel Filter.....	FC-5516
Fuel Filter Secondary.....	FC-5515
Fuel Filter Secondary.....	FC-55151
Oil Filter Full Flow.....	C-5522
928F (LOADERS) CAT S/N: 6RR177-657-UP	
Fuel Filter Secondary.....	FC-5515
Fuel Filter.....	FC-5516
Fuel Filter Secondary.....	FC-55151
Oil Filter Full Flow.....	C-5522
928F (LOADERS) CAT S/N: 6RR658-UP	
Fuel Filter Secondary.....	FC-55151
Fuel Filter.....	FC-5516
Fuel Filter Secondary.....	FC-5515
Oil Filter Full Flow.....	C-5522
928F (LOADERS) CAT S/N: 98Z15832-UP	
Fuel Filter Secondary.....	FC-5515
Fuel Filter.....	FC-5516
Fuel Filter Secondary.....	FC-55151
Oil Filter Full Flow.....	C-5522
928F (LOADERS) CAT S/N: 98Z4533-15831-UP	

MODEL/APPLICATION	SAKURA NO
CATERPILLAR	
Fuel Filter Secondary.....	FC-55151
Fuel Filter.....	FC-5516
Fuel Filter Secondary.....	FC-5515
Oil Filter Full Flow.....	C-5522
928F (LOADERS) CAT S/N: 98Z820-4532-UP	
Fuel Filter.....	FC-5501
Oil Filter Full Flow.....	C-5522
928F (LOADERS) S/N: 2XL1-578-UP	
Air Filter Set.....	A-5568-S
Air Filter Primary.....	A-5566
Air Filter Secondary.....	A-5567
Cabin Air Filter.....	CA-55070
Hydraulic Oil Filter.....	HC-5504
Hydraulic Oil Filter.....	H-5506
928F (LOADERS) S/N: 2XL1757-UP	
Air Filter Secondary.....	A-5567
Air Filter Primary.....	A-5566
Air Filter Set.....	A-5568-S
Cabin Air Filter.....	CA-55070
Hydraulic Oil Filter.....	H-5506
928F (LOADERS) S/N: 2XL1-UP	
Air Filter Set.....	A-5568-S
Air Filter Primary.....	A-5566
Air Filter Secondary.....	A-5567
Fuel Filter Secondary.....	FC-55151
Fuel Filter.....	F-5505
Fuel Filter Secondary.....	FC-5515
Fuel Filter.....	FC-5516
Hydraulic Oil Filter.....	HC-5504
Hydraulic Oil Filter.....	H-5506
Oil Filter Full Flow.....	C-5510
928F (LOADERS) S/N: 2XL579-1756-UP	
Air Filter Secondary.....	A-5567
Air Filter Primary.....	A-5566
Air Filter Set.....	A-5568-S
Cabin Air Filter.....	CA-55070
Hydraulic Oil Filter.....	HC-5504
Hydraulic Oil Filter.....	H-5506
928F (LOADERS) S/N: 7YM1-UP	
Fuel Filter Secondary.....	FC-55151
Fuel Filter.....	FC-5516
Fuel Filter Secondary.....	FC-5515
Hydraulic Oil Filter.....	HC-5508
Hydraulic Oil Filter.....	H-5506
Oil Filter Full Flow.....	C-5510
928F (LOADERS) S/N: 8AK11-UP	
Air Filter Set.....	A-5568-S
Air Filter Primary.....	A-5566
Air Filter Secondary.....	A-5567
Fuel Filter Secondary.....	FC-5515
Fuel Filter.....	FC-5516

MODEL/APPLICATION	SAKURA NO
CATERPILLAR	
Fuel Filter Secondary.....	FC-55151
Hydraulic Oil Filter.....	H-5506
Hydraulic Oil Filter.....	HC-5508
Oil Filter Full Flow.....	C-5510
928F (LOADERS) S/N: 8AK1-494-UP	
Air Filter Secondary.....	A-5567
Air Filter Primary.....	A-5566
Air Filter Set.....	A-5568-S
Cabin Air Filter.....	CA-55070
Hydraulic Oil Filter.....	HC-5508
Hydraulic Oil Filter.....	H-5506
928F (LOADERS) S/N: 8AK1-699	
Air Filter Set.....	A-5568-S
Air Filter Primary.....	A-5566
Air Filter Secondary.....	A-5567
Fuel Filter.....	F-5505
Hydraulic Oil Filter.....	HC-5504
Hydraulic Oil Filter.....	H-5506
Oil Filter Full Flow.....	C-5510
928F (LOADERS) S/N: 8AK495-867-UP	
Air Filter Secondary.....	A-5567
Air Filter Primary.....	A-5566
Air Filter Set.....	A-5568-S
Cabin Air Filter.....	CA-55070
Hydraulic Oil Filter.....	HC-5508
Hydraulic Oil Filter.....	H-5506
928F (LOADERS) S/N: 8AK700-UP	
Air Filter Set.....	A-5568-S
Air Filter Primary.....	A-5566
Air Filter Secondary.....	A-5567
Fuel Filter.....	FC-5516
Fuel Filter Secondary.....	FC-5515
Fuel Filter Secondary.....	FC-55151
Fuel Filter.....	F-5505
Hydraulic Oil Filter.....	HC-5504
Hydraulic Oil Filter.....	H-5506
Oil Filter Full Flow.....	C-5510
928F (LOADERS) S/N: 8AK868-UP	
Air Filter Secondary.....	A-5567
Air Filter Primary.....	A-5566
Air Filter Set.....	A-5568-S
Cabin Air Filter.....	CA-55070
Hydraulic Oil Filter.....	H-5506
928G (LOADERS) CAT (S/N: 98Z1-130-UP)	
Fuel Filter Secondary.....	FC-55151
Fuel Filter Secondary.....	FC-5515
Fuel Filter.....	FC-5516
928G (LOADERS) CAT (S/N: 98Z131-UP)	
Fuel Filter.....	FC-5516
Fuel Filter.....	FC-5508
Fuel Filter Secondary.....	FC-5515

MODEL/APPLICATION	SAKURA NO	MODEL/APPLICATION	SAKURA NO	MODEL/APPLICATION	SAKURA NO
CATERPILLAR		CATERPILLAR		CATERPILLAR	
928G (LOADERS) CAT (S/N: 98Z131-UP) Fuel Filter Secondary..... FC-55151		928G (LOADERS) S/N: 6XR1-885-UP Air Filter Primary..... A-5566 Air Filter Secondary..... A-5567 Air Filter Set..... A-5568-S Hydraulic Oil Filter..... HC-5504		Fuel Filter..... F-5505 Fuel Filter Secondary..... FC-5507 Hydraulic Oil Filter..... H-5526 Hydraulic Oil Filter..... H-55280 Hydraulic Oil Filter..... H-5503 Oil Filter Full Flow..... C-5510	
928G (LOADERS) CAT (S/N: CPT1-UP) Fuel Filter..... FC-5517 Oil Filter Full Flow..... C-5522 Oil Filter Full Flow..... C-5101		928G (LOADERS) S/N: 6XR886-1542-UP Air Filter Set..... A-5568-S Air Filter Secondary..... A-5567 Air Filter Primary..... A-5566 Hydraulic Oil Filter..... HC-5504		930 (LOADERS) S/N: 41K1-2326 Air Filter Secondary..... A-5508 Air Filter Set..... A-55071-S Air Filter Set..... A-5507-S Air Filter Primary..... A-5507 Air Filter Set..... A-5568-S Air Filter Secondary..... A-5567 Air Filter Primary..... A-5566 Fuel Filter Secondary..... FC-5507 Hydraulic Oil Filter..... H-5503 Hydraulic Oil Filter..... H-5504 Oil Filter Full Flow..... C-5510	
928G (LOADERS) CAT 3056E ATAAC (S/N: 6XR1-UP) Air Filter Primary..... AS-8577 Air Filter Secondary..... A-8578 Fuel Filter Secondary..... FC-55151 Fuel Filter Secondary..... FC-5515 Fuel Filter..... FC-5508 Fuel Filter..... FC-5516 Hydraulic Oil Filter..... HC-5504 Oil Filter Full Flow..... C-5510		928G (LOADERS) S/N: 7SR1-1380-UP Air Filter Primary..... A-5566 Air Filter Secondary..... A-5567 Air Filter Set..... A-5568-S Hydraulic Oil Filter..... HC-5504		930 (LOADERS) S/N: 41K2327-5314 Air Filter Primary..... A-5566 Air Filter Secondary..... A-5567 Air Filter Set..... A-5568-S Air Filter Primary..... A-5507 Air Filter Set..... A-5507-S Air Filter Set..... A-55071-S Air Filter Secondary..... A-5508 Fuel Filter Secondary..... FC-5507 Hydraulic Oil Filter..... H-5504 Hydraulic Oil Filter..... H-5503 Oil Filter Full Flow..... C-5510	
928G (LOADERS) CAT 3056E ATAAC (S/N: 6XR-UP) Air Filter Secondary..... A-8578 Air Filter Primary..... AS-8577 Fuel Filter Secondary..... FC-5515 Fuel Filter Secondary..... FC-55151 Fuel Filter..... FC-5516 Hydraulic Oil Filter..... HC-5508 Hydraulic Oil Filter..... HC-5504 Oil Filter Full Flow..... C-5510		928G (LOADERS) S/N: 7SR1381-UP Air Filter Set..... A-5568-S Air Filter Secondary..... A-5567 Air Filter Primary..... A-5566 Hydraulic Oil Filter..... HC-5504		930 (LOADERS) S/N: 41K2327-5314 Air Filter Primary..... A-5566 Air Filter Secondary..... A-5567 Air Filter Set..... A-5568-S Air Filter Primary..... A-5507 Air Filter Set..... A-5507-S Air Filter Set..... A-55071-S Air Filter Secondary..... A-5508 Fuel Filter Secondary..... FC-5507 Hydraulic Oil Filter..... H-5504 Hydraulic Oil Filter..... H-5503 Oil Filter Full Flow..... C-5510	
928G (LOADERS) CAT 3056E ATAAC (S/N: 7SR1-UP) Air Filter Primary..... AS-8577 Air Filter Secondary..... A-8578 Fuel Filter Secondary..... FC-55151 Fuel Filter Secondary..... FC-5515 Fuel Filter..... FC-5516 Hydraulic Oil Filter..... HC-5504 Oil Filter Full Flow..... C-5510		928G (LOADERS) S/N: DJD1-UP Air Filter Primary..... A-5105 Air Filter Secondary..... A-5106 Air Filter Primary..... AS-8577 Air Filter Secondary..... A-8578 Hydraulic Oil Filter..... HC-5504		930 (LOADERS) S/N: 73M1-UP Air Filter Secondary..... A-5508 Air Filter Set..... A-55071-S Air Filter Set..... A-5507-S Air Filter Primary..... A-5507 Air Filter Set..... A-5568-S Air Filter Secondary..... A-5567 Air Filter Primary..... A-5566 Fuel Filter Secondary..... FC-5507 Hydraulic Oil Filter..... H-5503 Hydraulic Oil Filter..... H-5504 Oil Filter Full Flow..... C-5510	
928G (LOADERS) CAT S/N: 4TF25000-UP Fuel Filter Secondary..... FC-5515 Fuel Filter Secondary..... FC-55151 Fuel Filter..... FC-5516 Fuel Filter..... FC-5508 Oil Filter Full Flow..... C-5522		928G (LOADERS) S/N: WL61-UP Air Filter Secondary..... A-5106 Air Filter Primary..... A-5105 Air Filter Secondary..... A-8578 Air Filter Primary..... AS-8577 Hydraulic Oil Filter..... HC-5504		930 (LOADERS) S/N: 73M1-UP Air Filter Secondary..... A-5508 Air Filter Set..... A-55071-S Air Filter Set..... A-5507-S Air Filter Primary..... A-5507 Air Filter Set..... A-5568-S Air Filter Secondary..... A-5567 Air Filter Primary..... A-5566 Fuel Filter Secondary..... FC-5507 Hydraulic Oil Filter..... H-5503 Hydraulic Oil Filter..... H-5504 Oil Filter Full Flow..... C-5510	
928G (LOADERS) CAT S/N: 6RR1-UP Fuel Filter..... FC-5508 Fuel Filter..... FC-5516 Fuel Filter Secondary..... FC-55151 Fuel Filter Secondary..... FC-5515 Oil Filter Full Flow..... C-5522		930 (LOADERS) S/N: 17B1-219 Air Filter Primary..... A-5507 Air Filter Set..... A-5568-S Air Filter Primary..... A-5566 Air Filter Secondary..... A-5567 Air Filter Secondary..... A-5508 Air Filter Set..... A-55071-S Air Filter Set..... A-5507-S Fuel Filter..... F-5505 Hydraulic Oil Filter..... H-5503 Oil Filter Full Flow..... C-5510		930 (LOADERS) S/N: 79J1-UP Air Filter Primary..... A-5566 Air Filter Secondary..... A-5567 Air Filter Set..... A-5568-S Air Filter Primary..... A-5507 Air Filter Set..... A-5507-S Air Filter Set..... A-55071-S Air Filter Secondary..... A-5508 Fuel Filter Secondary..... FC-5507 Hydraulic Oil Filter..... H-5504 Hydraulic Oil Filter..... H-5503 Oil Filter Full Flow..... C-5510	
928G (LOADERS) S/N: 6XR1543-UP Air Filter Set..... A-5568-S Air Filter Secondary..... A-5567 Air Filter Primary..... A-5566 Hydraulic Oil Filter..... HC-5504		930 (LOADERS) S/N: 17B220-999 Air Filter Set..... A-5507-S Air Filter Set..... A-55071-S Air Filter Secondary..... A-5508 Air Filter Primary..... A-5507 Air Filter..... A-5530			

Sakura Filter

ENGINE APPLICATION

MODEL/APPLICATION	SAKURA NO
CATERPILLAR	
930G (LOADERS) CAT S/N: CPT1-UP , 2007-UP	
Air Filter Secondary.....	A-5106
Air Filter Primary.....	A-5105
Air Filter Secondary.....	A-8578
Air Filter Primary.....	AS-8577
Fuel Filter.....	FC-5517
Hydraulic Oil Filter.....	HC-5504
Oil Filter Full Flow.....	C-5522
Oil Filter Full Flow.....	C-5101
930G (LOADERS) CAT S/N: TFW1-UP , 2007-UP	
Air Filter Secondary.....	A-8578
Air Filter Primary.....	A-5105
Air Filter Secondary.....	A-5106
Air Filter Primary.....	AS-8577
Fuel Filter.....	FC-5517
Hydraulic Oil Filter.....	HC-5504
Oil Filter Full Flow.....	C-5101
Oil Filter Full Flow.....	C-5522
930G (LOADERS) CAT S/N: TWR1-786-UP , 2007-UP	
Air Filter Secondary.....	A-5106
Air Filter Primary.....	A-5105
Air Filter Secondary.....	A-8578
Air Filter Primary.....	AS-8577
Fuel Filter.....	FC-5517
Hydraulic Oil Filter.....	HC-5504
Oil Filter Full Flow.....	C-5522
Oil Filter Full Flow.....	C-5101
930G (LOADERS) CAT S/N: TWR787-UP , 2007-UP	
Air Filter Primary.....	A-5105
Air Filter Secondary.....	A-5106
Fuel Filter.....	FC-5517
Hydraulic Oil Filter.....	HC-5504
Oil Filter Full Flow.....	C-5101
Oil Filter Full Flow.....	C-5522
930R (LOADERS) CAT 3304	
Air Filter Primary.....	A-44180
Air Filter Set.....	A-44180-S
930R (LOADERS) CAT (S/N: 4YD1-1221)	
Fuel Filter.....	FC-5501
Oil Filter Full Flow.....	C-5510
930R (LOADERS) CAT (S/N: 4YD1222-2199)	
Fuel Filter.....	FC-5501
Oil Filter Full Flow.....	C-5510
Oil Filter Full Flow.....	C-5522
930R (LOADERS) CAT (S/N: 4YD2200-UP)	
Fuel Filter.....	FC-5501
Oil Filter Full Flow.....	C-5522
930R (LOADERS) S/N: 57Z1275-3999	
Air Filter Primary.....	A-5507
Air Filter Set.....	A-55071-S
Air Filter.....	A-5530

MODEL/APPLICATION	SAKURA NO
CATERPILLAR	
Air Filter Set.....	A-5507-S
Air Filter Set.....	A-55071-S
Air Filter Primary.....	A-5507
Air Filter Secondary.....	A-5508
Hydraulic Oil Filter.....	H-5501
Hydraulic Oil Filter.....	H-5503
930R (LOADERS) S/N: 57Z1-3016	
Air Filter Primary.....	A-5507
Air Filter Set.....	A-55071-S
Air Filter Set.....	A-5507-S
Air Filter Secondary.....	A-5508
Fuel Filter.....	F-5505
Fuel Filter Secondary.....	FC-5507
Hydraulic Oil Filter.....	H-55280
Hydraulic Oil Filter.....	H-5526
Hydraulic Oil Filter.....	H-5503
Oil Filter Full Flow.....	C-5510
930R (LOADERS) S/N: 57Z1-3999	
Air Filter Set.....	A-5507-S
Air Filter Set.....	A-55071-S
Air Filter Primary.....	A-5507
Air Filter Secondary.....	A-5567
Air Filter Primary.....	A-5566
Air Filter Set.....	A-5568-S
Air Filter Secondary.....	A-5508
Fuel Filter Secondary.....	FC-5507
Hydraulic Oil Filter.....	H-5503
Oil Filter Full Flow.....	C-5510
930R (LOADERS) S/N: 57Z1-971	
Hydraulic Oil Filter.....	H-5501
Hydraulic Oil Filter.....	H-5503
930R (LOADERS) S/N: 57Z3017-3999	
Air Filter Primary.....	A-5507
Air Filter Set.....	A-55071-S
Air Filter Set.....	A-5507-S
Air Filter Secondary.....	A-5508
Fuel Filter Secondary.....	FC-5507
Fuel Filter.....	F-5505
Hydraulic Oil Filter.....	H-5526
Hydraulic Oil Filter.....	H-55280
Hydraulic Oil Filter.....	H-5503
Oil Filter Full Flow.....	C-5510
930R (LOADERS) S/N: 57Z4000-4612	
Air Filter Set.....	A-5507-S
Air Filter.....	A-5530
Air Filter Set.....	A-55071-S
Air Filter Primary.....	A-5507
Hydraulic Oil Filter.....	H-5501
Hydraulic Oil Filter.....	H-5503
930R (LOADERS) S/N: 57Z4613-UP	
Air Filter Primary.....	A-5507
Air Filter Set.....	A-55071-S
Air Filter.....	A-5530

MODEL/APPLICATION	SAKURA NO
CATERPILLAR	
Air Filter Set.....	A-5507-S
Hydraulic Oil Filter.....	H-5503
Hydraulic Oil Filter.....	H-5501
930R (LOADERS) S/N: 57Z972-1274	
Air Filter Secondary.....	A-5508
Air Filter Set.....	A-5507-S
Air Filter Set.....	A-55071-S
Air Filter Primary.....	A-5507
Hydraulic Oil Filter.....	H-5501
Hydraulic Oil Filter.....	H-5503
930T (LOADERS) S/N: 17B1000-2010	
Air Filter.....	A-5530
Air Filter Set.....	A-5507-S
Air Filter Primary.....	A-5507
Air Filter Set.....	A-55071-S
Fuel Filter.....	F-5505
Fuel Filter Secondary.....	FC-5507
Hydraulic Oil Filter.....	H-5503
Hydraulic Oil Filter.....	H-5526
Hydraulic Oil Filter.....	H-55280
Oil Filter Full Flow.....	C-5510
930T (LOADERS) S/N: 57Z4000-UP	
Air Filter.....	A-5530
Air Filter Primary.....	A-5507
Air Filter Set.....	A-5507-S
Air Filter Set.....	A-55071-S
Fuel Filter Secondary.....	FC-5507
Fuel Filter.....	F-5505
Hydraulic Oil Filter.....	H-55280
Hydraulic Oil Filter.....	H-5526
Hydraulic Oil Filter.....	H-5503
Oil Filter Full Flow.....	C-5510
930T SERIES II (LOADERS) S/N: 17B2011-UP	
Air Filter Primary.....	A-5509
Air Filter.....	A-5530
Air Filter Set.....	A-5522-S
Fuel Filter.....	F-5505
Fuel Filter Secondary.....	FC-5507
Hydraulic Oil Filter.....	H-55280
Hydraulic Oil Filter.....	H-5526
Hydraulic Oil Filter.....	H-5503
Oil Filter Full Flow.....	C-5510
931 (LOADERS) S/N: 10N1-UP	
Air Filter Secondary.....	A-5525
Air Filter Set.....	A-5542-S
Air Filter Primary.....	A-5542
Fuel Filter.....	FC-5503
Hydraulic Oil Filter.....	H-5504
Oil Filter Full Flow.....	C-5504
931 (LOADERS) S/N: 78U1-UP	
Air Filter Primary.....	A-5542
Air Filter Set.....	A-5542-S

MODEL/APPLICATION	SAKURA NO
CATERPILLAR	
931 (LOADERS) S/N: 78U1-UP	
Air Filter Secondary.....	A-5525
Fuel Filter.....	FC-5503
Hydraulic Oil Filter.....	H-5504
Oil Filter Full Flow.....	C-5504
931 (LOADERS) S/N: 81U1-UP	
Air Filter Secondary.....	A-5525
Air Filter Set.....	A-5542-S
Air Filter Primary.....	A-5542
Fuel Filter.....	FC-5503
Oil Filter Full Flow.....	C-5504
931 (LOADERS) w/3204 Eng.	
Air Filter Secondary.....	A-5590
931B (LOADERS) CAT 3204	
Air Filter Secondary.....	A-5525
Air Filter Primary.....	A-5542
Air Filter Set.....	A-5542-S
Fuel Filter.....	FC-5503
Hydraulic Oil Filter.....	H-5504
Oil Filter Full Flow.....	C-5519
931B (LOADERS) S/N: 25Y1-UP	
Air Filter Set.....	A-5542-S
Air Filter Primary.....	A-5542
Air Filter Secondary.....	A-5525
Fuel Filter.....	FC-5503
Hydraulic Oil Filter.....	H-5504
Hydraulic Oil Filter.....	H-55270
Oil Filter Full Flow.....	C-5519
931B (LOADERS) S/N: 26Y1-UP	
Air Filter Secondary.....	A-5525
Air Filter Primary.....	A-5542
Air Filter Set.....	A-5542-S
Fuel Filter.....	FC-5503
Hydraulic Oil Filter.....	H-55270
Hydraulic Oil Filter.....	H-5504
Oil Filter Full Flow.....	C-5519
931B (LOADERS) S/N: 29Y1-UP	
Air Filter Primary.....	A-5542
Air Filter Secondary.....	A-5525
Air Filter Set.....	A-5542-S
Fuel Filter.....	FC-5503
Hydraulic Oil Filter.....	H-5504
Oil Filter Full Flow.....	C-5519
931B (LOADERS) S/N: 30Y1-UP	
Air Filter Set.....	A-5542-S
Air Filter Secondary.....	A-5525
Air Filter Primary.....	A-5542
Fuel Filter.....	FC-5503
Hydraulic Oil Filter.....	H-5504
Hydraulic Oil Filter.....	H-55270

MODEL/APPLICATION	SAKURA NO
CATERPILLAR	
Oil Filter Full Flow.....	C-5519
931B (LOADERS) S/N: 4SC1-UP	
Air Filter Set.....	A-5542-S
Air Filter Primary.....	A-5542
Air Filter Secondary.....	A-5525
Fuel Filter.....	FC-5503
Hydraulic Oil Filter.....	H-55270
Hydraulic Oil Filter.....	H-5504
Oil Filter Full Flow.....	C-5519
931B (LOADERS) S/N: 6EC1-UP	
Air Filter Set.....	A-5542-S
Air Filter Secondary.....	A-5525
Air Filter Primary.....	A-5542
Fuel Filter.....	FC-5503
Hydraulic Oil Filter.....	H-5504
Hydraulic Oil Filter.....	H-55270
Oil Filter Full Flow.....	C-5519
931B (LOADERS) w/3204 Eng.	
Air Filter Secondary.....	A-5590
Hydraulic Oil Filter.....	H-55320
931C (LOADERS) S/N: 2B31-UP	
Air Filter Secondary.....	A-5525
Air Filter Set.....	A-5542-S
Air Filter Primary.....	A-5542
Fuel Filter.....	FC-5503
Fuel Filter Secondary.....	FC-5507
Hydraulic Oil Filter.....	H-55270
Oil Filter Full Flow.....	C-5519
931C (LOADERS) S/N: 5LG1-UP	
Air Filter Primary.....	A-5542
Air Filter Set.....	A-5542-S
Air Filter Secondary.....	A-5525
Fuel Filter Secondary.....	FC-5507
Fuel Filter.....	FC-5503
Hydraulic Oil Filter.....	H-55270
Oil Filter Full Flow.....	C-5519
931C (LOADERS) S/N: 6RF1-UP	
Air Filter Secondary.....	A-5525
Air Filter Set.....	A-5542-S
Air Filter Primary.....	A-5542
Fuel Filter.....	FC-5503
Hydraulic Oil Filter.....	H-5504
Oil Filter Full Flow.....	C-5519
931C (LOADERS) S/N: 7HF1-UP	
Air Filter Set.....	A-5542-S
Air Filter Secondary.....	A-5525
Air Filter Primary.....	A-5542
Fuel Filter Secondary.....	FC-5507
Hydraulic Oil Filter.....	H-5504
Hydraulic Oil Filter.....	H-55270
Oil Filter Full Flow.....	C-5519

MODEL/APPLICATION	SAKURA NO
CATERPILLAR	
931C (LOADERS) S/N: 8AF1-UP	
Air Filter Primary.....	A-5542
Air Filter Secondary.....	A-5525
Air Filter Set.....	A-5542-S
Fuel Filter Secondary.....	FC-5507
Hydraulic Oil Filter.....	H-55270
Hydraulic Oil Filter.....	H-5504
Oil Filter Full Flow.....	C-5519
931C (LOADERS) w/3204 Eng.	
Air Filter Secondary.....	A-5590
Hydraulic Oil Filter.....	H-55320
933 (LOADERS) CAT (S/N: 5XK1-UP)	
Fuel Filter.....	FC-1010
Fuel Filter.....	FC-5516
Fuel Filter Secondary.....	FC-5515
Fuel Filter Secondary.....	FC-55151
Oil Filter Full Flow.....	C-5504
933 (LOADERS) S/N: 11A-UP	
Oil Filter Full Flow.....	O-5501
933 (LOADERS) S/N: 16G1-UP	
Air Filter Primary.....	A-5542
Air Filter Set.....	A-5542-S
Air Filter Secondary.....	A-5525
Hydraulic Oil Filter.....	H-55270
Hydraulic Oil Filter.....	H-5504
Oil Filter Full Flow.....	C-5504
933 (LOADERS) S/N: 2331-UP	
Air Filter Secondary.....	A-5525
Air Filter Set.....	A-5542-S
Air Filter Primary.....	A-5542
Hydraulic Oil Filter.....	H-5504
Hydraulic Oil Filter.....	H-55270
Oil Filter Full Flow.....	C-5504
933 (LOADERS) S/N: 59D1-UP	
Air Filter Secondary.....	A-5525
Air Filter Primary.....	A-5542
Air Filter Set.....	A-5542-S
Hydraulic Oil Filter.....	H-55270
Hydraulic Oil Filter.....	H-5504
Oil Filter Full Flow.....	C-5504
933 (LOADERS) S/N: 8FL1-392	
Air Filter Secondary.....	A-5525
Air Filter Set.....	A-5542-S
Air Filter Primary.....	A-5542
Cabin Air Filter.....	CA-55070
Hydraulic Oil Filter.....	H-5501
Hydraulic Oil Filter.....	H-5504
933 (LOADERS) S/N: 8FL1-UP	

Sakura Filter

ENGINE APPLICATION

MODEL/APPLICATION	SAKURA NO	MODEL/APPLICATION	SAKURA NO	MODEL/APPLICATION	SAKURA NO
CATERPILLAR		CATERPILLAR		CATERPILLAR	
933 (LOADERS) S/N: 8FL1-UP Air Filter Primary..... A-5542 Air Filter Set..... A-5542-S Air Filter Secondary..... A-5525 Hydraulic Oil Filter..... H-5504 Hydraulic Oil Filter..... H-55270 Oil Filter Full Flow..... C-5504		933C (LOADERS) CAT S/N: 4MS1-UP Air Filter Secondary..... A-5525 Air Filter Set..... A-5542-S Air Filter Primary..... A-5542 Cabin Air Filter..... CA-55070 Fuel Filter Secondary..... FC-55151 Fuel Filter Secondary..... FC-5515 Fuel Filter..... FC-5516 Fuel Filter..... FC-1010 Hydraulic Oil Filter..... HC-5504 Oil Filter Full Flow..... C-5504		935C (LOADERS) S/N: 8CF1-UP Air Filter Primary..... A-5542 Air Filter Set..... A-5542-S Air Filter Secondary..... A-5525 Fuel Filter Secondary..... FC-5507 Hydraulic Oil Filter..... H-5504 Oil Filter Full Flow..... C-5519	
933 (LOADERS) S/N: 8FL393-UP Air Filter Secondary..... A-5525 Air Filter Set..... A-5542-S Air Filter Primary..... A-5542 Cabin Air Filter..... CA-55070 Hydraulic Oil Filter..... H-5501 Hydraulic Oil Filter..... H-5504		933C (LOADERS) CAT S/N: 5JS1-UP Air Filter Primary..... A-5542 Air Filter Set..... A-5542-S Air Filter Secondary..... A-5525 Cabin Air Filter..... CA-55070 Fuel Filter..... FC-1010 Fuel Filter..... FC-5516 Fuel Filter Secondary..... FC-5515 Fuel Filter Secondary..... FC-55151 Hydraulic Oil Filter..... HC-5504 Oil Filter Full Flow..... C-5504		935C (LOADERS) w/3204 Eng. Air Filter Secondary..... A-5590 Hydraulic Oil Filter..... H-55320	
933 (LOADERS) S/N: 9EL109-UP Air Filter Primary..... A-5542 Air Filter Set..... A-5542-S Air Filter Secondary..... A-5525 Cabin Air Filter..... CA-55070 Hydraulic Oil Filter..... H-5504 Hydraulic Oil Filter..... H-5501		933C (LOADERS) CAT S/N: 5JS1-UP Air Filter Primary..... A-5542 Air Filter Set..... A-5542-S Air Filter Secondary..... A-5525 Cabin Air Filter..... CA-55070 Fuel Filter..... FC-1010 Fuel Filter..... FC-5516 Fuel Filter Secondary..... FC-5515 Fuel Filter Secondary..... FC-55151 Hydraulic Oil Filter..... HC-5504 Oil Filter Full Flow..... C-5504		935CII (LOADERS) CAT (S/N: 45V90750-UP) Fuel Filter..... FC-5501 Oil Filter Full Flow..... C-5519	
933 (LOADERS) S/N: 9EL1-108 Air Filter Secondary..... A-5525 Air Filter Set..... A-5542-S Air Filter Primary..... A-5542 Cabin Air Filter..... CA-55070 Hydraulic Oil Filter..... H-5501 Hydraulic Oil Filter..... H-5504		933C (LOADERS) CAT S/N: 5XK1-UP Air Filter Secondary..... A-5525 Air Filter Set..... A-5542-S Air Filter Primary..... A-5542 Cabin Air Filter..... CA-55070 Fuel Filter Secondary..... FC-55151 Fuel Filter Secondary..... FC-5515 Fuel Filter..... FC-5516 Fuel Filter..... FC-1010 Hydraulic Oil Filter..... HC-5504 Oil Filter Full Flow..... C-5504		935CII (LOADERS) CAT (S/N: 7YJ1-2721-UP) Fuel Filter Secondary..... FC-5507 Fuel Filter..... FC-5501 Oil Filter Full Flow..... C-5519 Oil Filter Full Flow..... C-5505	
933 (LOADERS) S/N: 9EL1-UP Air Filter Primary..... A-5542 Air Filter Set..... A-5542-S Air Filter Secondary..... A-5525 Hydraulic Oil Filter..... H-5504 Hydraulic Oil Filter..... H-55270 Oil Filter Full Flow..... C-5504		933C (LOADERS) CAT S/N: 5XK1-UP Air Filter Secondary..... A-5525 Air Filter Set..... A-5542-S Air Filter Primary..... A-5542 Cabin Air Filter..... CA-55070 Fuel Filter Secondary..... FC-55151 Fuel Filter Secondary..... FC-5515 Fuel Filter..... FC-5516 Fuel Filter..... FC-1010 Hydraulic Oil Filter..... HC-5504 Oil Filter Full Flow..... C-5504		935CII (LOADERS) CAT (S/N: 7YJ2722-UP) Fuel Filter..... FC-5501 Fuel Filter Secondary..... FC-5507 Oil Filter Full Flow..... C-5505 Oil Filter Full Flow..... C-5519	
933 (LOADERS) S/N: 9EL1-UP Air Filter Primary..... A-5542 Air Filter Set..... A-5542-S Air Filter Secondary..... A-5525 Hydraulic Oil Filter..... H-5504 Hydraulic Oil Filter..... H-55270 Oil Filter Full Flow..... C-5504		935B (LOADERS) S/N: 3DF1-UP Air Filter Secondary..... A-5525 Air Filter Primary..... A-5542 Air Filter Set..... A-5542-S Fuel Filter..... FC-5503 Hydraulic Oil Filter..... H-55270 Hydraulic Oil Filter..... H-5504 Oil Filter Full Flow..... C-5519		936 (LOADERS) CAT (S/N: 12Z1-UP) Air Filter Secondary..... A-5522 Air Filter Set..... A-5522-S Air Filter Primary..... A-5509 Fuel Filter Secondary..... FC-5507 Oil Filter Full Flow..... C-5522	
933 (LOADERS) w/3046 Eng. Air Filter Secondary..... A-5590 Hydraulic Oil Filter..... H-55320		935B (LOADERS) w/3204 Eng. Air Filter Secondary..... A-5590 Hydraulic Oil Filter..... H-55320		936 (LOADERS) S/N: 33Z1-3090 Air Filter Secondary..... A-5522 Air Filter Primary..... A-5509 Air Filter Set..... A-5522-S Fuel Filter Secondary..... FC-5507 Fuel Filter..... F-5505 Hydraulic Oil Filter..... H-5506 Oil Filter Full Flow..... C-5510	
933C (LOADERS) CAT 3046 (S/N: 4MS1-UP) Air Filter Secondary..... A-5525 Air Filter Set..... A-5542-S Air Filter Primary..... A-5542 Hydraulic Oil Filter..... HC-5504 Oil Filter Full Flow..... C-5504		933C (LOADERS) S/N: 5D31-UP Air Filter Secondary..... A-5525 Air Filter Set..... A-5542-S Air Filter Primary..... A-5542 Fuel Filter..... FC-5503 Hydraulic Oil Filter..... H-5504 Oil Filter Full Flow..... C-5519		936 (LOADERS) S/N: 33Z1-UP Hydraulic Oil Filter..... H-5501	
933C (LOADERS) CAT 3046 (S/N: 5JS1-UP) Air Filter Primary..... A-5542 Air Filter Set..... A-5542-S Air Filter Secondary..... A-5525 Hydraulic Oil Filter..... HC-5504 Oil Filter Full Flow..... C-5504		933C (LOADERS) S/N: 5D31-UP Air Filter Secondary..... A-5525 Air Filter Set..... A-5542-S Air Filter Primary..... A-5542 Fuel Filter..... FC-5503 Hydraulic Oil Filter..... H-5504 Oil Filter Full Flow..... C-5519		936 (LOADERS) S/N: 45Z1-1359 Hydraulic Oil Filter..... H-5501	

MODEL/APPLICATION	SAKURA NO
CATERPILLAR	
936 (LOADERS) S/N: 45Z1-3056	
Air Filter Set.....	A-5522-S
Air Filter Primary.....	A-5509
Air Filter Primary.....	A-5549
Air Filter Primary.....	A-5549M
Air Filter Set.....	A-5549M-S
Air Filter Secondary.....	A-5550
Air Filter Secondary.....	A-5522
Fuel Filter Secondary.....	FC-5507
Fuel Filter.....	F-5505
Hydraulic Oil Filter.....	H-5506
Oil Filter Full Flow.....	C-5510
936 (LOADERS) S/N: 45Z1360-2340	
Hydraulic Oil Filter.....	H-5501
936 (LOADERS) S/N: 45Z2341-UP	
Hydraulic Oil Filter.....	H-5501
936 (LOADERS) S/N: 45B1-UP	
Air Filter Secondary.....	A-5522
Air Filter Primary.....	A-5509
Air Filter Set.....	A-5522-S
Fuel Filter Secondary.....	FC-5507
Fuel Filter.....	F-5505
Hydraulic Oil Filter.....	H-5506
Oil Filter Full Flow.....	C-5510
936 (LOADERS) S/N: 45B-UP	
Air Filter Set.....	A-5522-S
Air Filter Primary.....	A-5509
Air Filter Secondary.....	A-5550
Air Filter Set.....	A-5549M-S
Air Filter Primary.....	A-5549M
Air Filter Primary.....	A-5549
Fuel Filter Secondary.....	FC-5507
Fuel Filter.....	FC-5501
Hydraulic Oil Filter.....	H-5506
Oil Filter Full Flow.....	C-5510
936 (LOADERS) S/N: 45Z-UP	
Air Filter Primary.....	A-5549
Air Filter Primary.....	A-5549M
Air Filter Set.....	A-5549M-S
Air Filter Secondary.....	A-5550
Air Filter Primary.....	A-5509
Air Filter Set.....	A-5522-S
Fuel Filter.....	FC-5501
Fuel Filter Secondary.....	FC-5507
Hydraulic Oil Filter.....	H-5506
Oil Filter Full Flow.....	C-5510
936E (LOADERS) CAT 3304 (S/N: 33Z1-UP)	
Air Filter Primary.....	A-5509
Air Filter Set.....	A-5522-S
Air Filter Secondary.....	A-5522
Fuel Filter.....	F-5505
Fuel Filter Secondary.....	FC-5507
Hydraulic Oil Filter.....	H-5506
Oil Filter Full Flow.....	C-5510

MODEL/APPLICATION	SAKURA NO
CATERPILLAR	
Fuel Filter Secondary.....	FC-5507
Hydraulic Oil Filter.....	H-5506
Oil Filter Full Flow.....	C-5505
Oil Filter Full Flow.....	C-5510
936E (LOADERS) CAT 3304 (S/N: 45Z1-UP)	
Air Filter Secondary.....	A-5522
Air Filter Set.....	A-5522-S
Air Filter Primary.....	A-5509
Fuel Filter Secondary.....	FC-5507
Fuel Filter.....	F-5505
Hydraulic Oil Filter.....	H-5506
Oil Filter Full Flow.....	C-5510
Oil Filter Full Flow.....	C-5505
936E (LOADERS) CAT 3304 (S/N: 45B1-UP)	
Air Filter Primary.....	A-5509
Air Filter Set.....	A-5522-S
Air Filter Secondary.....	A-5522
Fuel Filter.....	F-5505
Fuel Filter Secondary.....	FC-5507
Hydraulic Oil Filter.....	H-5506
Oil Filter Full Flow.....	C-5505
Oil Filter Full Flow.....	C-5510
936E (LOADERS) S/N: 33Z3091-UP	
Air Filter Primary.....	A-5509
Air Filter Secondary.....	A-5522
Air Filter Set.....	A-5522-S
Fuel Filter Secondary.....	FC-5507
Fuel Filter.....	F-5505
Hydraulic Oil Filter.....	H-5506
Oil Filter Full Flow.....	C-5510
936E (LOADERS) S/N: 45Z3057-UP	
Air Filter Primary.....	A-5509
Air Filter Set.....	A-5522-S
Air Filter Secondary.....	A-5522
Fuel Filter.....	F-5505
Fuel Filter Secondary.....	FC-5507
Hydraulic Oil Filter.....	H-5506
Oil Filter Full Flow.....	C-5510
936E (LOADERS) S/N: 45B1623-UP	
Air Filter Set.....	A-5522-S
Air Filter Primary.....	A-5509
Fuel Filter Secondary.....	FC-5507
Hydraulic Oil Filter.....	H-5506
Oil Filter Full Flow.....	C-5505
936E (LOADERS) S/N: 45B1624-UP	
Air Filter Primary.....	A-5509
Air Filter Set.....	A-5522-S
Air Filter Secondary.....	A-5522
Fuel Filter Secondary.....	FC-5507
Fuel Filter.....	F-5505
Hydraulic Oil Filter.....	H-5506
Oil Filter Full Flow.....	C-5510

MODEL/APPLICATION	SAKURA NO
CATERPILLAR	
936F (LOADERS) S/N: 4TK1-UP	
Air Filter Secondary.....	A-5522
Air Filter Set.....	A-5522-S
Air Filter Primary.....	A-5509
Air Filter Secondary.....	A-5550
Air Filter Set.....	A-5549M-S
Air Filter Primary.....	A-5549M
Air Filter Primary.....	A-5549
Fuel Filter.....	F-5505
Fuel Filter Secondary.....	FC-5507
Hydraulic Oil Filter.....	H-5506
Oil Filter Full Flow.....	C-5510
936F (LOADERS) S/N: 8AJ1-UP	
Air Filter Primary.....	A-5549
Air Filter Primary.....	A-5549M
Air Filter Set.....	A-5549M-S
Air Filter Secondary.....	A-5550
Air Filter Primary.....	A-5509
Air Filter Set.....	A-5522-S
Air Filter Secondary.....	A-5522
Fuel Filter.....	F-5505
Fuel Filter Secondary.....	FC-5507
Hydraulic Oil Filter.....	H-5506
Oil Filter Full Flow.....	C-5510
936F (LOADERS) S/N: 9MK1-UP	
Air Filter Secondary.....	A-5522
Air Filter Set.....	A-5522-S
Air Filter Primary.....	A-5509
Fuel Filter Secondary.....	FC-5507
Fuel Filter.....	F-5505
Hydraulic Oil Filter.....	H-5506
Oil Filter Full Flow.....	C-5510
938F (LOADERS) CAT (S/N: 4TF28600-32197)	
Fuel Filter.....	FC-5508
Oil Filter Full Flow.....	C-5522
938F (LOADERS) CAT S/N: 4TF14130-28599	
Fuel Filter Secondary.....	FC-55151
Fuel Filter.....	FC-5516
Fuel Filter Secondary.....	FC-5515
Oil Filter Full Flow.....	C-5522
938F (LOADERS) CAT S/N: 4TF32198-UP	
Fuel Filter.....	FC-5508
Fuel Filter Secondary.....	FC-5515
Fuel Filter.....	FC-5516
Fuel Filter Secondary.....	FC-55151
Oil Filter Full Flow.....	C-5522
938F (LOADERS) CAT S/N: 98Z17000-UP	
Fuel Filter Secondary.....	FC-55151
Fuel Filter.....	FC-5516
Fuel Filter Secondary.....	FC-5515
Fuel Filter.....	FC-5508

MODEL/APPLICATION	SAKURA NO
CATERPILLAR	
938F (LOADERS) CAT S/N: 98Z17000-UP	
Oil Filter Full Flow.....	C-5522
938F (LOADERS) CAT S/N: 98Z5104-16999	
Fuel Filter Secondary.....	FC-5515
Fuel Filter.....	FC-5516
Fuel Filter Secondary.....	FC-55151
Oil Filter Full Flow.....	C-5522
938F (LOADERS) S/N: 1KM1-1799	
Air Filter Secondary.....	A-5550
Air Filter Primary.....	A-5549
Air Filter Primary.....	A-5549M
Air Filter Set.....	A-5549M-S
Cabin Air Filter.....	CA-55070
Hydraulic Oil Filter.....	H-5506
Hydraulic Oil Filter.....	HC-5504
938F (LOADERS) S/N: 1KM1800-UP	
Air Filter Set.....	A-5549M-S
Air Filter Primary.....	A-5549M
Air Filter Primary.....	A-5549
Air Filter Secondary.....	A-5550
Cabin Air Filter.....	CA-55070
Hydraulic Oil Filter.....	HC-5504
Hydraulic Oil Filter.....	H-5506
938F (LOADERS) S/N: 1KM1-UP	
Air Filter Secondary.....	A-5550
Air Filter Primary.....	A-5549
Air Filter Primary.....	A-5549M
Air Filter Set.....	A-5549M-S
Fuel Filter Secondary.....	FC-55151
Fuel Filter.....	FC-5516
Fuel Filter Secondary.....	FC-5515
Fuel Filter.....	FC-5508
Fuel Filter.....	F-5505
Hydraulic Oil Filter.....	HC-5504
Hydraulic Oil Filter.....	H-5506
Oil Filter Full Flow.....	C-5510
938F (LOADERS) S/N: 2RM1-1123	
Air Filter Set.....	A-5549M-S
Air Filter Primary.....	A-5549M
Air Filter Primary.....	A-5549
Air Filter Secondary.....	A-5550
Cabin Air Filter.....	CA-55070
Hydraulic Oil Filter.....	HC-5504
Hydraulic Oil Filter.....	H-5506
Hydraulic Oil Filter.....	HC-5508
938F (LOADERS) S/N: 2RM1124-UP	
Air Filter Primary.....	A-5549
Air Filter Primary.....	A-5549M
Air Filter Set.....	A-5549M-S
Air Filter Secondary.....	A-5550
Cabin Air Filter.....	CA-55070

MODEL/APPLICATION	SAKURA NO
CATERPILLAR	
Hydraulic Oil Filter.....	HC-5508
Hydraulic Oil Filter.....	H-5506
Hydraulic Oil Filter.....	HC-5504
938F (LOADERS) S/N: 2RM-1291	
Air Filter Secondary.....	A-5550
Air Filter Set.....	A-5549M-S
Air Filter Primary.....	A-5549M
Air Filter Primary.....	A-5549
Fuel Filter Secondary.....	FC-55151
Fuel Filter Secondary.....	FC-5515
Fuel Filter.....	FC-5516
Fuel Filter.....	FC-5508
Hydraulic Oil Filter.....	HC-5504
Hydraulic Oil Filter.....	H-5506
Oil Filter Full Flow.....	C-5510
938F (LOADERS) S/N: 2RM1-UP	
Fuel Filter.....	F-5505
Oil Filter Full Flow.....	C-5510
938F (LOADERS) S/N: 7SN1-310	
Air Filter Primary.....	A-5549
Air Filter Primary.....	A-5549M
Air Filter Set.....	A-5549M-S
Air Filter Secondary.....	A-5550
Cabin Air Filter.....	CA-55070
Hydraulic Oil Filter.....	HC-5508
Hydraulic Oil Filter.....	H-5506
938F (LOADERS) S/N: 7SN1-UP	
Fuel Filter.....	F-5505
Hydraulic Oil Filter.....	H-5506
Oil Filter Full Flow.....	C-5510
938F (LOADERS) S/N: 7SN311-384	
Air Filter Set.....	A-5549M-S
Air Filter Primary.....	A-5549M
Air Filter Primary.....	A-5549
Air Filter Secondary.....	A-5550
Cabin Air Filter.....	CA-55070
Hydraulic Oil Filter.....	H-5506
Hydraulic Oil Filter.....	HC-5504
938F (LOADERS) S/N: 7SN385-UP	
Air Filter Primary.....	A-5549
Air Filter Primary.....	A-5549M
Air Filter Set.....	A-5549M-S
Air Filter Secondary.....	A-5550
Cabin Air Filter.....	CA-55070
Hydraulic Oil Filter.....	HC-5504
Hydraulic Oil Filter.....	H-5506
938F (LOADERS) S/N: 8SM1-UP	
Air Filter Primary.....	A-5549
Air Filter Set.....	A-5549M-S
Air Filter Primary.....	A-5549M
Air Filter Secondary.....	A-5550

MODEL/APPLICATION	SAKURA NO
CATERPILLAR	
Fuel Filter.....	F-5505
Fuel Filter.....	FC-5516
Fuel Filter Secondary.....	FC-5515
Fuel Filter Secondary.....	FC-55151
Hydraulic Oil Filter.....	HC-5504
Hydraulic Oil Filter.....	H-5506
Oil Filter Full Flow.....	C-5510
938G (LOADERS) CAT (S/N: 55K1-UP)	
Fuel Filter Secondary.....	FC-55151
Fuel Filter Secondary.....	FC-5515
Fuel Filter.....	FC-5516
Fuel Filter.....	FC-5508
Oil Filter Full Flow.....	C-5522
938G (LOADERS) CAT (S/N: 6JK1-UP)	
Fuel Filter.....	FC-5508
Fuel Filter.....	FC-5516
Fuel Filter Secondary.....	FC-5515
Fuel Filter Secondary.....	FC-55151
Oil Filter Full Flow.....	C-5522
938G (LOADERS) CAT 3126B ATAAC HEUI (S/N: 4YS1-UP)	
Air Filter Secondary.....	A-5550
Fuel Filter Secondary.....	FC-55151
Fuel Filter Secondary.....	FC-5515
Fuel Filter.....	FC-5516
Fuel Filter.....	FC-5508
Hydraulic Oil Filter.....	H-5506
Hydraulic Oil Filter.....	HC-5504
Oil Filter Full Flow.....	C-5510
938G (LOADERS) CAT 3126B ATAAC HEUI (S/N: 6WS1-682)	
Air Filter Secondary.....	A-5550
Fuel Filter.....	FC-5508
Fuel Filter.....	FC-5516
Fuel Filter Secondary.....	FC-5515
Fuel Filter Secondary.....	FC-55151
Hydraulic Oil Filter.....	HC-5504
Hydraulic Oil Filter.....	H-5506
Oil Filter Full Flow.....	C-5510
938G (LOADERS) CAT 3126B ATAAC HEUI (S/N: 6WS683-UP)	
Air Filter Secondary.....	A-5550
Fuel Filter Secondary.....	FC-55151
Fuel Filter Secondary.....	FC-5515
Fuel Filter.....	FC-5516
Fuel Filter.....	FC-5508
Hydraulic Oil Filter.....	H-5506
Hydraulic Oil Filter.....	HC-5504
Oil Filter Full Flow.....	C-5510
938G (LOADERS) CAT 3126B ATAAC HEUI (S/N: 8RS1-610)	
Air Filter Secondary.....	A-5550
Fuel Filter.....	FC-5508
Fuel Filter.....	FC-5516
Fuel Filter Secondary.....	FC-5515
Fuel Filter Secondary.....	FC-55151
Hydraulic Oil Filter.....	HC-5504

Sakura Filter

ENGINE APPLICATION

MODEL/APPLICATION	SAKURA NO	MODEL/APPLICATION	SAKURA NO	MODEL/APPLICATION	SAKURA NO
CATERPILLAR		CATERPILLAR		CATERPILLAR	
938G (LOADERS) CAT 3126B ATAAC HEUI (S/N: 8RS1-610)		Hydraulic Oil Filter.....	HC-55280	Hydraulic Oil Filter.....	H-5502
Hydraulic Oil Filter.....	H-5506	938G SERIES II (LOADERS) CAT (S/N: 5GG1-UP)		Hydraulic Oil Filter.....	H-5508
Oil Filter Full Flow.....	C-5510	Fuel Filter.....	FC-5517	Oil Filter Full Flow.....	C-5510
938G (LOADERS) CAT 3126B ATAAC HEUI (S/N: 8RS611-UP)		Oil Filter Full Flow.....	C-5522	939 (LOADERS) S/N: 9GL1-UP	
Air Filter Secondary.....	A-5550	938G SERIES II (LOADERS) CAT (S/N: BMA1-UP)		Air Filter Primary.....	A-5542
Fuel Filter Secondary.....	FC-55151	Fuel Filter.....	FC-5517	Air Filter Set.....	A-5542-S
Fuel Filter Secondary.....	FC-5515	Oil Filter Full Flow.....	C-5522	Air Filter Secondary.....	A-5525
Fuel Filter.....	FC-5516	938G SERIES II (LOADERS) S/N: CRD1-UP		Hydraulic Oil Filter.....	H-5504
Fuel Filter.....	FC-5508	Air Filter Primary.....	A-5558	Hydraulic Oil Filter.....	H-55270
Hydraulic Oil Filter.....	H-5506	Air Filter Secondary.....	A-5559	Oil Filter Full Flow.....	C-5504
Hydraulic Oil Filter.....	HC-5504	Hydraulic Oil Filter.....	H-5506	939 (LOADERS) w/3046 Eng.	
Oil Filter Full Flow.....	C-5510	Hydraulic Oil Filter.....	HC-5504	Air Filter Secondary.....	A-5590
938G (LOADERS) CAT 3126B ATAAC HEUI (S/N: 9HS1-UP)		938G SERIES II (LOADERS) S/N: PHN1-UP		Hydraulic Oil Filter.....	H-55320
Air Filter Secondary.....	A-5550	Air Filter Secondary.....	A-5559	939C (LOADERS) CAT 3046T (S/N: 6DS1-UP)	
Fuel Filter.....	FC-5508	Air Filter Primary.....	A-5558	Air Filter Secondary.....	A-5525
Fuel Filter.....	FC-5516	Hydraulic Oil Filter.....	HC-5504	Air Filter Primary.....	A-5542
Fuel Filter Secondary.....	FC-5515	Hydraulic Oil Filter.....	H-5506	Air Filter Set.....	A-5542-S
Fuel Filter Secondary.....	FC-55151	938G SERIES II (LOADERS) S/N: RTB1-UP		Hydraulic Oil Filter.....	HC-5504
Hydraulic Oil Filter.....	HC-5504	Air Filter Primary.....	A-5558	Oil Filter Full Flow.....	C-5504
Hydraulic Oil Filter.....	H-5506	Air Filter Secondary.....	A-5559	939C (LOADERS) CAT S/N: 5XK12250-UP	
Oil Filter Full Flow.....	C-5510	Hydraulic Oil Filter.....	H-5506	Air Filter Set.....	A-5542-S
938G (LOADERS) S/N: 4YS1-511		Hydraulic Oil Filter.....	HC-5504	Air Filter Primary.....	A-5542
Air Filter Secondary.....	A-5550	939 (LOADERS) CAT S/N: 5XK1-UP		Air Filter Secondary.....	A-5525
Air Filter Set.....	A-5549M-S	Air Filter Secondary.....	A-5525	Air Filter Primary.....	A-5542
Air Filter Primary.....	A-5549M	Air Filter Set.....	A-5542-S	Air Filter Secondary.....	A-5525
Air Filter Primary.....	A-5549	Air Filter Primary.....	A-5542	Cabin Air Filter.....	CA-55070
Hydraulic Oil Filter.....	H-5506	Cabin Air Filter.....	CA-55070	Fuel Filter.....	FC-1010
Hydraulic Oil Filter.....	HC-5504	Fuel Filter.....	FC-5516	Hydraulic Oil Filter.....	HC-5504
938G (LOADERS) S/N: 4YS512-UP		Fuel Filter Secondary.....	FC-5515	Oil Filter Full Flow.....	C-5504
Air Filter Primary.....	A-5549	Fuel Filter Secondary.....	FC-55151	939C (LOADERS) CAT S/N: 6DS1-UP	
Air Filter Primary.....	A-5549M	Fuel Filter.....	FC-1010	Air Filter Secondary.....	A-5525
Air Filter Set.....	A-5549M-S	Hydraulic Oil Filter.....	H-5501	Air Filter Primary.....	A-5542
Air Filter Secondary.....	A-5550	Hydraulic Oil Filter.....	H-5504	Air Filter Set.....	A-5542-S
Hydraulic Oil Filter.....	HC-5504	Hydraulic Oil Filter.....	H-5501	Cabin Air Filter.....	CA-55070
Hydraulic Oil Filter.....	H-5506	Oil Filter Full Flow.....	C-5504	Fuel Filter.....	FC-1010
938G (LOADERS) S/N: 9HS1-280		939 (LOADERS) CAT S/N: 9GL1-UP		Hydraulic Oil Filter.....	HC-5504
Air Filter Secondary.....	A-5550	Air Filter Primary.....	A-5542	Oil Filter Full Flow.....	C-5504
Hydraulic Oil Filter.....	H-5506	Air Filter Set.....	A-5542-S	939C (LOADERS) w/3046T Eng.	
Hydraulic Oil Filter.....	HC-5504	Air Filter Secondary.....	A-5525	Air Filter Secondary.....	A-5590
938G (LOADERS) S/N: 9HS281-743		Cabin Air Filter.....	CA-55070	941 (LOADERS) Except S/N 75H	
Air Filter Secondary.....	A-5550	Fuel Filter.....	FC-1010	Hydraulic Oil Filter.....	H-55320
Hydraulic Oil Filter.....	HC-5504	Fuel Filter Secondary.....	FC-55151	941 (LOADERS) S/N: 16U1-UP	
Hydraulic Oil Filter.....	H-5506	Fuel Filter Secondary.....	FC-5515	Air Filter Secondary.....	A-5508
938G (LOADERS) S/N: 9HS744-UP		Fuel Filter.....	FC-5516	Fuel Filter Secondary.....	FC-5507
Air Filter Secondary.....	A-5550	Hydraulic Oil Filter.....	H-5504	Hydraulic Oil Filter.....	H-5504
Hydraulic Oil Filter.....	H-5506	Hydraulic Oil Filter.....	H-5501	Hydraulic Oil Filter.....	H-5508
Hydraulic Oil Filter.....	HC-5504	Hydraulic Oil Filter.....	H-5501	Hydraulic Oil Filter.....	H-5502
938H (LOADERS) w/C6.6 Eng.		Oil Filter Full Flow.....	C-5504	Oil Filter Full Flow.....	O-5502
Air Filter Secondary.....	A-5550	939 (LOADERS)		Oil Filter Full Flow.....	C-5510
Hydraulic Oil Filter.....	H-5506	Air Filter Secondary.....	A-5525	941 (LOADERS) S/N: 70H1-UP	
Hydraulic Oil Filter.....	HC-5504	Air Filter Set.....	A-5542-S	Air Filter Secondary.....	A-5508
938H (LOADERS) w/C6.6 Eng.		Air Filter Primary.....	A-5542	Fuel Filter Secondary.....	FC-5507
Air Filter Secondary.....	A-5550			Hydraulic Oil Filter.....	H-5504
Hydraulic Oil Filter.....	H-5506			Hydraulic Oil Filter.....	H-5508
Hydraulic Oil Filter.....	HC-5504			Hydraulic Oil Filter.....	H-5502
				Oil Filter Full Flow.....	O-5502
				Oil Filter Full Flow.....	C-5510

MODEL/APPLICATION	SAKURA NO	MODEL/APPLICATION	SAKURA NO	MODEL/APPLICATION	SAKURA NO
CATERPILLAR		CATERPILLAR		CATERPILLAR	
941 (LOADERS) S/N: 70H1-UP Air Filter Secondary..... A-5508 Fuel Filter Secondary..... FC-5507 Hydraulic Oil Filter..... H-5502 Hydraulic Oil Filter..... H-5508 Hydraulic Oil Filter..... H-5504 Oil Filter Full Flow..... C-5510 Oil Filter Full Flow..... O-5502		Air Filter Secondary..... A-5567 Air Filter Secondary..... A-5508 Air Filter Primary..... A-5507 Air Filter Set..... A-5507-S Fuel Filter Secondary..... FC-5507 Hydraulic Oil Filter..... H-5504 Hydraulic Oil Filter..... H-5508 Hydraulic Oil Filter..... H-5502 Oil Filter Full Flow..... C-5510		Fuel Filter Secondary..... FC-5507 Fuel Filter..... F-5505 Hydraulic Oil Filter..... H-5506 Oil Filter Full Flow..... C-5505	
941 (LOADERS) S/N: 80H1-3039 Air Filter Secondary..... A-5508 Air Filter Primary..... A-5507 Air Filter Set..... A-5507-S Air Filter Set..... A-5568-S Air Filter Primary..... A-5566 Air Filter Secondary..... A-5567 Air Filter Set..... A-55071-S Fuel Filter Secondary..... FC-5507 Hydraulic Oil Filter..... H-5504 Hydraulic Oil Filter..... H-5508 Hydraulic Oil Filter..... H-5502 Oil Filter Full Flow..... O-5502		941B (LOADERS) S/N: 80H3087-80H3087 Air Filter Set..... A-5507-S Air Filter Primary..... A-5507 Air Filter Secondary..... A-5508 Air Filter Secondary..... A-5567 Air Filter Set..... A-55071-S Air Filter Primary..... A-5566 Air Filter Set..... A-5568-S Fuel Filter Secondary..... FC-5507 Hydraulic Oil Filter..... H-5502 Hydraulic Oil Filter..... H-5508 Hydraulic Oil Filter..... H-5504 Oil Filter Full Flow..... C-5510		943 (LOADERS) S/N: 1921-1378 Air Filter Set..... A-55071-S Air Filter Primary..... A-5507 Air Filter Set..... A-5507-S Air Filter..... A-5530 Air Filter Secondary..... A-5567 Air Filter Set..... A-5568-S Air Filter Primary..... A-5566 Fuel Filter Secondary..... FC-5507 Hydraulic Oil Filter..... H-5506 Hydraulic Oil Filter..... H-55280 Oil Filter Full Flow..... C-5505	
941 (LOADERS) S/N: 80H3087-UP Air Filter Secondary..... A-5567 Air Filter Primary..... A-5566 Air Filter Set..... A-5568-S Air Filter Set..... A-5507-S Air Filter Primary..... A-5507 Air Filter Secondary..... A-5508 Air Filter Set..... A-55071-S Fuel Filter Secondary..... FC-5507 Hydraulic Oil Filter..... H-5502 Hydraulic Oil Filter..... H-5508 Hydraulic Oil Filter..... H-5504 Oil Filter Full Flow..... O-5502		941B (LOADERS) S/N: 80H3884-UP Air Filter Set..... A-5507-S Air Filter Secondary..... A-5508 Air Filter Primary..... A-5507 Air Filter Set..... A-55071-S Hydraulic Oil Filter..... H-5504 Hydraulic Oil Filter..... H-5508 Hydraulic Oil Filter..... H-5502 Oil Filter Full Flow..... C-5510		943 (LOADERS) S/N: 1921379-UP Air Filter Primary..... A-5566 Air Filter Set..... A-5568-S Air Filter Secondary..... A-5567 Air Filter..... A-5530 Air Filter Set..... A-5507-S Air Filter Primary..... A-5507 Air Filter Set..... A-55071-S Fuel Filter Secondary..... FC-5507 Hydraulic Oil Filter..... H-5506 Hydraulic Oil Filter..... H-55270 Oil Filter Full Flow..... C-5505	
941B (LOADERS) Except S/N 75H Hydraulic Oil Filter..... H-55320		941B (LOADERS) S/N: 80H5702-80H5702 Air Filter Set..... A-55071-S Air Filter Primary..... A-5507 Air Filter Secondary..... A-5508 Air Filter Set..... A-5507-S Fuel Filter..... FC-5510 Hydraulic Oil Filter..... H-5504 Hydraulic Oil Filter..... H-55270 Oil Filter Full Flow..... O-5501		943 (LOADERS) S/N: 31Y1-UP Air Filter Secondary..... A-5567 Air Filter Set..... A-5568-S Air Filter Primary..... A-5566 Air Filter Set..... A-5542-S Air Filter Primary..... A-5542 Air Filter Secondary..... A-5525 Fuel Filter..... FC-5503 Oil Filter Full Flow..... C-5505	
941B (LOADERS) S/N: 80H3040-3084 Air Filter Set..... A-5507-S Air Filter Primary..... A-5507 Air Filter Secondary..... A-5508 Air Filter Secondary..... A-5567 Air Filter Set..... A-55071-S Air Filter Primary..... A-5566 Air Filter Set..... A-5568-S Fuel Filter Secondary..... FC-5507 Hydraulic Oil Filter..... H-5502 Hydraulic Oil Filter..... H-5508 Hydraulic Oil Filter..... H-5504 Oil Filter Full Flow..... O-5502		943 (LOADERS) S/N: 03Y1-1385 Air Filter Set..... A-55071-S Air Filter Primary..... A-5507 Air Filter Set..... A-5507-S Air Filter..... A-5530 Fuel Filter..... F-5505 Fuel Filter Secondary..... FC-5507 Hydraulic Oil Filter..... H-5506 Oil Filter Full Flow..... C-5505		943 (LOADERS) S/N: 4Z1-UP Air Filter Primary..... A-5566 Air Filter Set..... A-5568-S Air Filter Secondary..... A-5567 Air Filter Set..... A-55071-S Air Filter Primary..... A-5507 Air Filter Set..... A-5507-S Air Filter..... A-5530 Air Filter..... A-5548 Fuel Filter Secondary..... FC-5507 Hydraulic Oil Filter..... H-5503 Hydraulic Oil Filter..... H-5506 Oil Filter Full Flow..... C-5505	
941B (LOADERS) S/N: 80H3085-UP Air Filter Set..... A-5568-S Air Filter Primary..... A-5566 Air Filter Set..... A-55071-S		943 (LOADERS) S/N: 03Y1386-UP Air Filter..... A-5530 Air Filter Set..... A-5507-S Air Filter Primary..... A-5507 Air Filter Set..... A-55071-S		943 LGP (LOADERS) S/N: 1921-252 Air Filter Set..... A-5507-S Air Filter Primary..... A-5507 Air Filter Set..... A-55071-S	

MODEL/APPLICATION	SAKURA NO
-------------------	-----------

CATERPILLAR

943 LGP
(LOADERS)
S/N: 1921-252

Air Filter.....	A-5530
Fuel Filter.....	F-5505
Fuel Filter Secondary.....	FC-5507
Hydraulic Oil Filter.....	H-5506
Hydraulic Oil Filter.....	H-5526
Oil Filter Full Flow.....	C-5505

943 LGP
(LOADERS)
S/N: 192253-UP

Air Filter Secondary.....	A-5522
Air Filter Set.....	A-5522-S
Air Filter Primary.....	A-5509
Fuel Filter Secondary.....	FC-5507
Fuel Filter.....	F-5505
Hydraulic Oil Filter.....	H-5526
Hydraulic Oil Filter.....	H-5506
Hydraulic Oil Filter.....	H-5503
Hydraulic Oil Filter.....	H-55280
Oil Filter Full Flow.....	C-5505

944
(LOADERS)
S/N: 8731-UP

Air Filter Set.....	A-55071-S
Air Filter Secondary.....	A-5508
Air Filter Primary.....	A-5507
Air Filter Set.....	A-5507-S
Air Filter Secondary.....	A-5567
Air Filter Primary.....	A-5566
Air Filter Set.....	A-5568-S
Fuel Filter Secondary.....	FC-5507
Hydraulic Oil Filter.....	H-5503
Oil Filter Full Flow.....	O-5502

944A
(LOADERS)
S/N: 43A1-UP

Air Filter Set.....	A-5507-S
Air Filter Primary.....	A-5507
Air Filter Secondary.....	A-5508
Air Filter Set.....	A-55071-S
Air Filter Set.....	A-5568-S
Air Filter Primary.....	A-5566
Air Filter Secondary.....	A-5567
Fuel Filter.....	F-5501
Hydraulic Oil Filter.....	H-5503
Oil Filter Full Flow.....	O-5502

944A
(LOADERS)
S/N: 58A1-UP

Air Filter Secondary.....	A-5567
Air Filter Primary.....	A-5566
Air Filter Set.....	A-5568-S
Air Filter Set.....	A-55071-S
Air Filter Secondary.....	A-5508
Air Filter Primary.....	A-5507
Air Filter Set.....	A-5507-S
Fuel Filter Secondary.....	FC-5507
Hydraulic Oil Filter.....	H-5503
Oil Filter Full Flow.....	O-5502

94U
(SKIDDERS)

MODEL/APPLICATION	SAKURA NO
-------------------	-----------

CATERPILLAR

Fuel Filter..... F-5503

950
(LOADERS)
S/N: 31K1016-1200

Air Filter Set.....	A-55071-S
Air Filter Secondary.....	A-5508
Air Filter Primary.....	A-5507
Air Filter Set.....	A-5507-S
Air Filter Secondary.....	A-5567
Air Filter Primary.....	A-5566
Air Filter Set.....	A-5568-S
Fuel Filter Secondary.....	FC-5507
Hydraulic Oil Filter.....	H-5503
Hydraulic Oil Filter.....	H-5504
Oil Filter Full Flow.....	C-5510

950
(LOADERS)
S/N: 31K1-1015

Air Filter Set.....	A-5507-S
Air Filter Primary.....	A-5507
Air Filter Secondary.....	A-5508
Air Filter Set.....	A-55071-S
Hydraulic Oil Filter.....	H-5504
Hydraulic Oil Filter.....	H-5503
Oil Filter Full Flow.....	O-5502

950
(LOADERS)
S/N: 31K1201-UP

Air Filter Set.....	A-55071-S
Air Filter Secondary.....	A-5508
Air Filter Primary.....	A-5507
Air Filter Set.....	A-5507-S
Air Filter Set.....	A-5568-S
Air Filter Primary.....	A-5566
Air Filter Secondary.....	A-5567
Fuel Filter Secondary.....	FC-5507
Hydraulic Oil Filter.....	H-5504
Hydraulic Oil Filter.....	H-5503
Oil Filter Full Flow.....	C-5510

950
(LOADERS)
S/N: 8111-4272

Air Filter Secondary.....	A-5508
Air Filter Set.....	A-5507-S
Air Filter Primary.....	A-5507
Air Filter Set.....	A-55071-S
Hydraulic Oil Filter.....	H-5504
Hydraulic Oil Filter.....	H-5503
Oil Filter Full Flow.....	O-5502

950
(LOADERS)
S/N: 81J4273-5410

Air Filter Set.....	A-55071-S
Air Filter Primary.....	A-5507
Air Filter Set.....	A-5507-S
Air Filter Secondary.....	A-5508
Air Filter Secondary.....	A-5567
Air Filter Primary.....	A-5566
Air Filter Set.....	A-5568-S
Fuel Filter Secondary.....	FC-5507
Hydraulic Oil Filter.....	H-5504
Hydraulic Oil Filter.....	H-5503
Oil Filter Full Flow.....	C-5510

MODEL/APPLICATION	SAKURA NO
-------------------	-----------

CATERPILLAR

950
(LOADERS)
S/N: 81J5411-UP

Air Filter Secondary.....	A-5508
Air Filter Set.....	A-5507-S
Air Filter Primary.....	A-5507
Air Filter Set.....	A-55071-S
Air Filter Set.....	A-5568-S
Air Filter Primary.....	A-5566
Air Filter Secondary.....	A-5567
Fuel Filter Secondary.....	FC-5507
Hydraulic Oil Filter.....	H-5503
Hydraulic Oil Filter.....	H-5504
Oil Filter Full Flow.....	C-5510

950
(LOADERS)
S/N: 90A1-UP

Air Filter Secondary.....	A-5567
Air Filter Primary.....	A-5566
Air Filter Set.....	A-5568-S
Air Filter Set.....	A-55071-S
Air Filter Primary.....	A-5507
Air Filter Set.....	A-5507-S
Air Filter Secondary.....	A-5508
Fuel Filter.....	F-5501
Hydraulic Oil Filter.....	H-5503
Oil Filter Full Flow.....	O-5502

950
(LOADERS)
w/3304 Eng.

Hydraulic Oil Filter.....	H-55320
---------------------------	---------

950F
(LOADERS)
CAT (S/N: 4TF1202-5321)

Fuel Filter.....	FC-5501
Oil Filter Full Flow.....	C-5510
Oil Filter Full Flow.....	C-5522

950F
(LOADERS)
CAT (S/N: 4TF17863-24499)

Fuel Filter.....	FC-5501
Fuel Filter.....	FC-5516
Fuel Filter Secondary.....	FC-55151
Fuel Filter Secondary.....	FC-5515
Oil Filter Full Flow.....	C-5522
Oil Filter Full Flow.....	C-5510

950F
(LOADERS)
CAT (S/N: 4TF1-985)

Fuel Filter.....	FC-5501
------------------	---------

950F
(LOADERS)
CAT (S/N: 4TF24500-UP)

Fuel Filter.....	FC-5501
Fuel Filter Secondary.....	FC-55151
Fuel Filter.....	FC-5516
Fuel Filter Secondary.....	FC-5515
Fuel Filter.....	FC-5508
Oil Filter Full Flow.....	C-5510
Oil Filter Full Flow.....	C-5522

950F
(LOADERS)
CAT (S/N: 4TF5322-9463)

Fuel Filter.....	FC-5501
Oil Filter Full Flow.....	C-5522

Sakura Filter

ENGINE APPLICATION

MODEL/APPLICATION	SAKURA NO	MODEL/APPLICATION	SAKURA NO	MODEL/APPLICATION	SAKURA NO
CATERPILLAR		CATERPILLAR		CATERPILLAR	
950F (LOADERS) CAT (S/N: 4TF5322-9463) Oil Filter Full Flow..... C-5510		Oil Filter Full Flow..... C-5522		Air Filter Set..... A-5549M-S	
950F (LOADERS) CAT (S/N: 4TF9464-17862) Fuel Filter..... FC-5501		950F (LOADERS) CAT S/N: 4TF1199-1199 Fuel Filter..... FC-5501		Fuel Filter..... FC-5508	
Fuel Filter..... FC-5516		Oil Filter Full Flow..... C-5522		Hydraulic Oil Filter..... H-5506	
Fuel Filter Secondary..... FC-55151		Oil Filter Full Flow..... C-5510		Oil Filter Full Flow..... C-5510	
Fuel Filter Secondary..... FC-5515		950F (LOADERS) CAT S/N: 4TF1200-1201 Fuel Filter..... FC-5501		950F (LOADERS) S/N: 5SK977-2333 Air Filter Set..... A-5549M-S	
Oil Filter Full Flow..... C-5510		Oil Filter Full Flow..... C-5510		Air Filter Set..... A-5522-S	
Oil Filter Full Flow..... C-5522		950F (LOADERS) CAT S/N: 4TF986-1171 Fuel Filter..... FC-5501		Air Filter Primary..... A-5509	
950F (LOADERS) CAT (S/N: 98Z1-2349) Fuel Filter..... FC-5501		Oil Filter Full Flow..... C-5522		Air Filter Primary..... A-5549	
Oil Filter Full Flow..... C-5522		Oil Filter Full Flow..... C-5510		Air Filter Secondary..... A-5550	
950F (LOADERS) CAT (S/N: 98Z14398-UP) Fuel Filter..... FC-5501		950F (LOADERS) S/N: 4DJ1-1999 Air Filter Primary..... A-5509		Air Filter Primary..... A-5549	
Fuel Filter Secondary..... FC-55151		Air Filter Set..... A-5522-S		Air Filter Set..... A-5522-S	
Fuel Filter..... FC-5516		Air Filter Secondary..... A-5522		Fuel Filter Secondary..... FC-5507	
Fuel Filter Secondary..... FC-5515		Fuel Filter..... F-5505		Fuel Filter..... F-5505	
Fuel Filter..... FC-5508		Fuel Filter Secondary..... FC-5507		Hydraulic Oil Filter..... H-5504	
Oil Filter Full Flow..... C-5522		Hydraulic Oil Filter..... H-5506		Hydraulic Oil Filter..... H-55270	
950F (LOADERS) CAT (S/N: 98Z2350-8479) Fuel Filter Secondary..... FC-5515		Oil Filter Full Flow..... C-5510		Hydraulic Oil Filter..... H-5506	
Fuel Filter..... FC-5516		950F (LOADERS) S/N: 4DJ1-1999 Air Filter Primary..... A-5509		950F (LOADERS) S/N: 6YG1-UP Air Filter Secondary..... A-5522	
Fuel Filter Secondary..... FC-55151		Air Filter Set..... A-5522-S		Air Filter..... A-5546	
Fuel Filter..... FC-5501		Air Filter Secondary..... A-5522		Air Filter Primary..... A-5509	
Oil Filter Full Flow..... C-5522		Fuel Filter..... F-5505		Air Filter Set..... A-5522-S	
950F (LOADERS) CAT (S/N: 98Z8480-14397) Fuel Filter..... FC-5501		Fuel Filter Secondary..... FC-5507		Fuel Filter Secondary..... FC-5507	
Fuel Filter Secondary..... FC-55151		Hydraulic Oil Filter..... H-5506		Fuel Filter..... FC-5515	
Fuel Filter..... FC-5516		Oil Filter Full Flow..... C-5510		Fuel Filter Secondary..... FC-55151	
Fuel Filter Secondary..... FC-5515		950F (LOADERS) S/N: 4DJ1-1999 Air Filter Primary..... A-5509		Hydraulic Oil Filter..... H-5501	
Fuel Filter..... FC-5508		Air Filter Set..... A-5549M-S		Hydraulic Oil Filter..... H-5506	
Oil Filter Full Flow..... C-5522		Air Filter Primary..... A-5549		950F (LOADERS) S/N: 6YG-UP Air Filter Set..... A-5549M-S	
950F (LOADERS) CAT S/N: 4TF1172-1172 Fuel Filter..... FC-5501		Air Filter Secondary..... A-5550		Air Filter Secondary..... A-5550	
Oil Filter Full Flow..... C-5522		Fuel Filter..... FC-5516		Air Filter Primary..... A-5549M	
Oil Filter Full Flow..... C-5510		Fuel Filter Secondary..... FC-55151		Fuel Filter..... F-5505	
950F (LOADERS) CAT S/N: 4TF1173-1178 Fuel Filter..... FC-5501		Fuel Filter Secondary..... FC-5507		Fuel Filter Secondary..... FC-5507	
Oil Filter Full Flow..... C-5510		Fuel Filter..... F-5505		Fuel Filter Secondary..... FC-5515	
Oil Filter Full Flow..... C-5522		Hydraulic Oil Filter..... H-5506		Fuel Filter..... FC-5516	
950F (LOADERS) CAT S/N: 4TF1179-1179 Fuel Filter..... FC-5501		Hydraulic Oil Filter..... H-5501		Fuel Filter Secondary..... FC-55151	
Oil Filter Full Flow..... C-5522		Hydraulic Oil Filter..... H-5506		Hydraulic Oil Filter..... H-5501	
Oil Filter Full Flow..... C-5510		950F (LOADERS) S/N: 5SK1-976 Air Filter Set..... A-5568-S		Hydraulic Oil Filter..... H-5506	
950F (LOADERS) CAT S/N: 4TF1180-1198 Fuel Filter..... FC-5501		Air Filter Primary..... A-5566		Hydraulic Oil Filter..... H-55270	
Oil Filter Full Flow..... C-5510		Air Filter Secondary..... A-5567		Oil Filter Full Flow..... C-5510	
950F (LOADERS) CAT S/N: 4TF1180-1198 Fuel Filter..... FC-5501		Fuel Filter Secondary..... FC-5507		950F (LOADERS) S/N: 7ZF1-UP Air Filter Set..... A-5549M-S	
Oil Filter Full Flow..... C-5510		Hydraulic Oil Filter..... H-5506		Air Filter Primary..... A-5549	
950F (LOADERS) CAT S/N: 4TF1180-1198 Fuel Filter..... FC-5501		Oil Filter Full Flow..... C-5510		Air Filter Secondary..... A-5550	
Oil Filter Full Flow..... C-5510		950F (LOADERS) S/N: 5SK2334-UP Air Filter Primary..... A-5549M		Air Filter Secondary..... A-5550	
950F (LOADERS) CAT S/N: 4TF1180-1198 Fuel Filter..... FC-5501		Air Filter Secondary..... A-5550		Air Filter Primary..... A-5549M	
Oil Filter Full Flow..... C-5510		Air Filter Primary..... A-5549		Air Filter Secondary..... A-5550	
950F (LOADERS) CAT S/N: 4TF1180-1198 Fuel Filter..... FC-5501		950F (LOADERS) S/N: 5SK2334-UP Air Filter Primary..... A-5549M		Air Filter Secondary..... A-5550	
Oil Filter Full Flow..... C-5510		Air Filter Secondary..... A-5550		Air Filter Primary..... A-5549M	
950F (LOADERS) CAT S/N: 4TF1180-1198 Fuel Filter..... FC-5501		Air Filter Primary..... A-5549		Air Filter Secondary..... A-5550	
Oil Filter Full Flow..... C-5510		950F (LOADERS) S/N: 5SK2334-UP Air Filter Primary..... A-5549M		Air Filter Secondary..... A-5550	
950F (LOADERS) CAT S/N: 4TF1180-1198 Fuel Filter..... FC-5501		Air Filter Secondary..... A-5550		Air Filter Primary..... A-5549M	
Oil Filter Full Flow..... C-5510		Air Filter Primary..... A-5549		Air Filter Secondary..... A-5550	

Sakura Filter

ENGINE APPLICATION

MODEL/APPLICATION	SAKURA NO	MODEL/APPLICATION	SAKURA NO	MODEL/APPLICATION	SAKURA NO
CATERPILLAR		CATERPILLAR		CATERPILLAR	
950F (LOADERS) S/N: 7ZF-UP Fuel Filter..... F-5505 Fuel Filter Secondary..... FC-5507 Fuel Filter Secondary..... FC-5515 Fuel Filter Secondary..... FC-55151 Fuel Filter..... FC-5516 Hydraulic Oil Filter..... H-5506 Hydraulic Oil Filter..... H-5501		Air Filter Primary..... A-5549M Fuel Filter..... F-5505 Fuel Filter Secondary..... FC-5507 Fuel Filter..... FC-5516 Fuel Filter Secondary..... FC-55151 Fuel Filter Secondary..... FC-5515 Hydraulic Oil Filter..... H-5501 Hydraulic Oil Filter..... H-5506 950B (LOADERS) CAT (S/N: 07Z1375-8554) Oil Filter Full Flow..... C-5510 950B (LOADERS) CAT (S/N: 07Z8555-8941) Fuel Filter Secondary..... FC-5507 Oil Filter Full Flow..... C-5510 Oil Filter Full Flow..... C-5522 950B (LOADERS) CAT (S/N: 07Z8942-UP) Fuel Filter Secondary..... FC-5507 950B (LOADERS) CAT (S/N: 12Z607-6185) Oil Filter Full Flow..... C-5510 950B (LOADERS) CAT (S/N: 12Z6186-11536) Oil Filter Full Flow..... C-5510 950B (LOADERS) S/N: 22Z1-3188 Air Filter Set..... A-5522-S Air Filter Primary..... A-5509 Air Filter Secondary..... A-5522 Fuel Filter Secondary..... FC-5507 Fuel Filter..... F-5505 Hydraulic Oil Filter..... H-5506 Oil Filter Full Flow..... C-5510 950B (LOADERS) S/N: 22Z1-811 Air Filter..... A-5546 Hydraulic Oil Filter..... H-5501 950B (LOADERS) S/N: 22Z4827-5259 Air Filter..... A-5546 Air Filter Primary..... A-5509 Air Filter Set..... A-5522-S Air Filter Secondary..... A-5522 Hydraulic Oil Filter..... H-5501 Hydraulic Oil Filter..... H-5506 950B (LOADERS) S/N: 22Z5260-5407 Air Filter Secondary..... A-5522 Air Filter Set..... A-5522-S Air Filter Primary..... A-5509 Air Filter..... A-5546 Hydraulic Oil Filter..... H-5506 950B (LOADERS) S/N: 22Z5408-UP Air Filter..... A-5546 Hydraulic Oil Filter..... H-5506		950B (LOADERS) S/N: 22Z812-4826 Air Filter..... A-5546 Air Filter Primary..... A-5509 Air Filter Set..... A-5522-S Air Filter Secondary..... A-5522 Hydraulic Oil Filter..... H-5501 950B (LOADERS) S/N: 31R1-UP Air Filter Secondary..... A-5522 Air Filter Set..... A-5522-S Air Filter Primary..... A-5509 Fuel Filter Secondary..... FC-5507 Fuel Filter..... F-5505 Hydraulic Oil Filter..... H-5506 Oil Filter Full Flow..... C-5510 950B (LOADERS) S/N: 63R1-5857 Hydraulic Oil Filter..... H-5501 950B (LOADERS) S/N: 63R1-6053 Air Filter Primary..... A-5509 Air Filter Set..... A-5522-S Air Filter Secondary..... A-5522 Fuel Filter Secondary..... FC-5507 Fuel Filter..... F-5505 Hydraulic Oil Filter..... H-5506 Oil Filter Full Flow..... C-5510 950B (LOADERS) S/N: 63R5858-6054 Air Filter Secondary..... A-5522 Air Filter Set..... A-5522-S Air Filter Primary..... A-5509 Hydraulic Oil Filter..... H-5501 950B (LOADERS) S/N: 63R6055-9191 Air Filter Primary..... A-5509 Air Filter Set..... A-5522-S Air Filter Secondary..... A-5522 Hydraulic Oil Filter..... H-5501 Hydraulic Oil Filter..... H-5506 950B (LOADERS) S/N: 63R9192-UP Air Filter Secondary..... A-5522 Air Filter Set..... A-5522-S Air Filter Primary..... A-5509 Hydraulic Oil Filter..... H-5506 950B (LOADERS) S/N: 65R1-UP Air Filter Secondary..... A-5522 Air Filter Primary..... A-5509 Air Filter Set..... A-5522-S Fuel Filter..... F-5505 Fuel Filter Secondary..... FC-5507 Hydraulic Oil Filter..... H-5506 Oil Filter Full Flow..... C-5510	
950F (LOADERS) S/N: 8TK03917-UP Air Filter Secondary..... A-5550 Air Filter Primary..... A-5549 Air Filter Set..... A-5549M-S Air Filter Primary..... A-5549M Cabin Air Filter..... CA-55070 Fuel Filter..... FC-5516 Fuel Filter Secondary..... FC-55151 Fuel Filter Secondary..... FC-5515 Hydraulic Oil Filter..... H-5506 Oil Filter Full Flow..... C-5510		950F (LOADERS) S/N: 8TK1-310 Air Filter Primary..... A-5549M Air Filter Set..... A-5549M-S Air Filter Primary..... A-5549 Air Filter Secondary..... A-5550 Fuel Filter Secondary..... FC-5507 Fuel Filter..... F-5505 Hydraulic Oil Filter..... H-5506 Oil Filter Full Flow..... C-5510		950F (LOADERS) S/N: 8TK2200-UP Air Filter Secondary..... A-5550 Air Filter Primary..... A-5549 Air Filter Set..... A-5549M-S Air Filter Primary..... A-5549M Hydraulic Oil Filter..... H-5506 Oil Filter Full Flow..... C-5510	
950F (LOADERS) S/N: 8TK311-2199 Air Filter Primary..... A-5549M Air Filter Secondary..... A-5522 Air Filter Set..... A-5549M-S Air Filter Primary..... A-5509 Air Filter Set..... A-5522-S Air Filter Primary..... A-5549 Air Filter Secondary..... A-5550 Fuel Filter Secondary..... FC-5515 Fuel Filter Secondary..... FC-55151 Fuel Filter..... FC-5516 Hydraulic Oil Filter..... H-5506 Oil Filter Full Flow..... C-5510		950F (LOADERS) S/N: 8TK-UP Air Filter Secondary..... A-5550 Air Filter Primary..... A-5549 Air Filter Set..... A-5549M-S			

MODEL/APPLICATION	SAKURA NO	MODEL/APPLICATION	SAKURA NO	MODEL/APPLICATION	SAKURA NO
CATERPILLAR		CATERPILLAR		CATERPILLAR	
950E (LOADERS) S/N: 22Z3189-UP Air Filter Primary..... A-5509 Air Filter Set..... A-5522-S Air Filter Secondary..... A-5522 Fuel Filter..... F-5505 Fuel Filter Secondary..... FC-5507 Hydraulic Oil Filter..... H-5506 Oil Filter Full Flow..... C-5510		Oil Filter Full Flow..... C-5510 950E (LOADERS) S/N: 65R3088-UP Air Filter Primary..... A-5549 Air Filter Set..... A-5522-S Air Filter Primary..... A-5509 Air Filter Secondary..... A-5550 Air Filter Secondary..... A-5522 Air Filter Primary..... A-5549M Air Filter Set..... A-5549M-S Fuel Filter Secondary..... FC-5507 Hydraulic Oil Filter..... H-5506 Oil Filter Full Flow..... C-5510		Hydraulic Oil Filter..... HC-5505 Oil Filter Full Flow..... C-5510 950G (LOADERS) CAT 3126 (S/N: 3JW1-UP) Air Filter Secondary..... A-5550 Fuel Filter..... FC-5516 Fuel Filter Secondary..... FC-55151 Fuel Filter Secondary..... FC-5515 Fuel Filter..... FC-5508 Hydraulic Oil Filter..... HC-5504 Oil Filter Full Flow..... C-5510	
950E (LOADERS) S/N: 22Z-UP Air Filter Set..... A-5522-S Air Filter Primary..... A-5509 Air Filter Set..... A-5549M-S Air Filter Primary..... A-5549M Air Filter Secondary..... A-5522 Air Filter Secondary..... A-5550 Air Filter Primary..... A-5549 Fuel Filter..... FC-5501 Fuel Filter Secondary..... FC-5507 Hydraulic Oil Filter..... H-5501 Hydraulic Oil Filter..... H-5506 Oil Filter Full Flow..... C-5510		950E (LOADERS) S/N: 65R3089-UP Air Filter Secondary..... A-5522 Air Filter Primary..... A-5509 Air Filter Set..... A-5522-S Fuel Filter..... F-5505 Fuel Filter Secondary..... FC-5507 Hydraulic Oil Filter..... H-5506 Oil Filter Full Flow..... C-5510		950G (LOADERS) CAT 3126 (S/N: 4BS1-UP) Air Filter Secondary..... A-5550 Fuel Filter..... FC-5508 Fuel Filter Secondary..... FC-5515 Fuel Filter Secondary..... FC-55151 Fuel Filter..... FC-5516 Hydraulic Oil Filter..... HC-5504 Oil Filter Full Flow..... C-5510	
950E (LOADERS) S/N: 31R-UP Air Filter Primary..... A-5549 Air Filter Primary..... A-5509 Air Filter Set..... A-5522-S Air Filter Secondary..... A-5550 Air Filter Secondary..... A-5522 Air Filter Primary..... A-5549M Air Filter Set..... A-5549M-S Fuel Filter Secondary..... FC-5507 Fuel Filter..... FC-5501 Hydraulic Oil Filter..... H-5501 Hydraulic Oil Filter..... H-5506 Oil Filter Full Flow..... C-5510		950E (LOADERS) S/N: 65R-UP Air Filter Set..... A-5522-S Air Filter Primary..... A-5509 Air Filter Secondary..... A-5522 Air Filter Secondary..... A-5550 Air Filter Primary..... A-5549 Air Filter Set..... A-5549M-S Air Filter Primary..... A-5549M Fuel Filter Secondary..... FC-5507 Fuel Filter..... FC-5501 Hydraulic Oil Filter..... H-5501 Hydraulic Oil Filter..... H-5506 Oil Filter Full Flow..... C-5510		950G (LOADERS) CAT 3126 (S/N: 5FW1-UP) Air Filter Secondary..... A-5550 Fuel Filter..... FC-5516 Fuel Filter Secondary..... FC-55151 Fuel Filter Secondary..... FC-5515 Fuel Filter..... FC-5508 Hydraulic Oil Filter..... HC-5504 Oil Filter Full Flow..... C-5510	
950E (LOADERS) S/N: 63R6054-UP Air Filter Set..... A-5522-S Air Filter Primary..... A-5509 Air Filter Secondary..... A-5522 Fuel Filter..... F-5505 Fuel Filter Secondary..... FC-5507 Hydraulic Oil Filter..... H-5506 Oil Filter Full Flow..... C-5510		950G (LOADERS) CAT (S/N: 55K1-UP) Fuel Filter..... FC-5508 Fuel Filter Secondary..... FC-5515 Fuel Filter Secondary..... FC-55151 Fuel Filter..... FC-5516 Oil Filter Full Flow..... C-5522		950G (LOADERS) CAT 3126 (S/N: 6NS1-UP) Air Filter Secondary..... A-5550 Fuel Filter..... FC-5516 Fuel Filter Secondary..... FC-55151 Fuel Filter Secondary..... FC-5515 Fuel Filter..... FC-5508 Hydraulic Oil Filter..... HC-5504 Oil Filter Full Flow..... C-5510	
950E (LOADERS) S/N: 63R-UP Air Filter Primary..... A-5509 Air Filter Set..... A-5522-S Air Filter Primary..... A-5549 Air Filter Set..... A-5549M-S Air Filter Primary..... A-5549M Air Filter Secondary..... A-5522 Air Filter Secondary..... A-5550 Fuel Filter..... FC-5501 Fuel Filter Secondary..... FC-5507 Hydraulic Oil Filter..... H-5501 Hydraulic Oil Filter..... H-5506		950G (LOADERS) CAT (S/N: 6JK1-UP) Fuel Filter..... FC-5516 Fuel Filter Secondary..... FC-55151 Fuel Filter Secondary..... FC-5515 Fuel Filter..... FC-5508 Oil Filter Full Flow..... C-5522		950G (LOADERS) CAT 3126 (S/N: 8JW1-UP) Air Filter Secondary..... A-5550 Fuel Filter..... FC-5508 Fuel Filter Secondary..... FC-5515 Fuel Filter Secondary..... FC-55151 Fuel Filter..... FC-5516 Hydraulic Oil Filter..... HC-5504 Oil Filter Full Flow..... C-5510	
950E (LOADERS) S/N: 63R-UP Air Filter Primary..... A-5509 Air Filter Set..... A-5522-S Air Filter Primary..... A-5549 Air Filter Set..... A-5549M-S Air Filter Primary..... A-5549M Air Filter Secondary..... A-5522 Air Filter Secondary..... A-5550 Fuel Filter..... FC-5501 Fuel Filter Secondary..... FC-5507 Hydraulic Oil Filter..... H-5501 Hydraulic Oil Filter..... H-5506		950G (LOADERS) CAT 3126 (S/N: 2JS1-UP) Air Filter Secondary..... A-5550 Fuel Filter..... FC-5508 Fuel Filter Secondary..... FC-5515 Fuel Filter Secondary..... FC-55151 Fuel Filter..... FC-5516 Hydraulic Oil Filter..... HC-5504		950G (LOADERS) CAT 3126B ATAAC HEUI (S/N: 6NS1-UP)	

MODEL/APPLICATION	SAKURA NO
CATERPILLAR	
950G (LOADERS) CAT 3126B ATAAC HEUI (S/N: 6NS1-UP)	
Air Filter Secondary.....	A-5550
Fuel Filter.....	FC-5516
Fuel Filter Secondary.....	FC-55151
Fuel Filter Secondary.....	FC-5515
Fuel Filter.....	FC-5508
Hydraulic Oil Filter.....	HC-5504
Oil Filter Full Flow.....	C-5510
950G (LOADERS) S/N: 2JS1-940	
Air Filter.....	A-25460
Air Filter Secondary.....	A-5550
Air Filter.....	A-5584
Hydraulic Oil Filter.....	HC-5504
950G (LOADERS) S/N: 2JS941-UP	
Air Filter.....	A-5584
Air Filter Secondary.....	A-5550
Air Filter.....	A-25460
Hydraulic Oil Filter.....	HC-5504
Hydraulic Oil Filter.....	HC-55170
Hydraulic Oil Filter.....	HC-5505
950G II (LOADERS) CAT (S/N: 5GG1-UP)	
Fuel Filter.....	FC-5517
Oil Filter Full Flow.....	C-5522
950G II (LOADERS) CAT (S/N: BMA1-UP)	
Fuel Filter.....	FC-5517
Oil Filter Full Flow.....	C-5522
950G II (LOADERS) S/N: A1-UP	
Air Filter Primary.....	A-5558
Air Filter Secondary.....	A-5559
Cabin Air Filter.....	CA-55070
Hydraulic Oil Filter.....	HC-5504
950G II (LOADERS) S/N: AXR1-UP	
Air Filter Secondary.....	A-5559
Air Filter Primary.....	A-5558
Cabin Air Filter.....	CA-55070
Hydraulic Oil Filter.....	HC-5504
950G II (LOADERS) S/N: AYB1-UP	
Air Filter Primary.....	A-5558
Air Filter.....	A-25460
Air Filter Secondary.....	A-5559
Cabin Air Filter.....	CA-55070
Hydraulic Oil Filter.....	HC-5504
Hydraulic Oil Filter.....	HC-5505
Hydraulic Oil Filter.....	HC-55170
950G II (LOADERS) S/N: AYL1-UP	
Air Filter.....	A-25460
Air Filter Primary.....	A-5558
Air Filter Secondary.....	A-5559

MODEL/APPLICATION	SAKURA NO
CATERPILLAR	
Cabin Air Filter.....	CA-55070
Hydraulic Oil Filter.....	HC-5504
950G II (LOADERS) S/N: BAA1-UP	
Air Filter Primary.....	A-5558
Air Filter Secondary.....	A-5559
Cabin Air Filter.....	CA-55070
Hydraulic Oil Filter.....	HC-5504
950H (LOADERS) CAT S/N: C7C1-UP , 2006-UP	
Cabin Air Filter.....	CA-55070
Fuel Filter.....	FC-5517
Hydraulic Oil Filter.....	HC-5504
Oil Filter Full Flow.....	C-5522
950H (LOADERS) CAT S/N: K5K2-UP , 2006-UP	
Cabin Air Filter.....	CA-55070
Fuel Filter.....	FC-5517
Hydraulic Oil Filter.....	HC-5504
Oil Filter Full Flow.....	C-5522
950H (LOADERS) CAT S/N: KHX1-UP , 2006-UP	
Cabin Air Filter.....	CA-55070
Fuel Filter.....	FC-5517
Hydraulic Oil Filter.....	HC-5504
Oil Filter Full Flow.....	C-5522
950H (LOADERS) CAT S/N: M1G1-UP , 2006-UP	
Cabin Air Filter.....	CA-55070
Fuel Filter.....	FC-5517
Hydraulic Oil Filter.....	HC-5504
Oil Filter Full Flow.....	C-5522
950H (LOADERS) CAT S/N: N1A1-UP , 2006-UP	
Cabin Air Filter.....	CA-55070
Fuel Filter.....	FC-5517
Hydraulic Oil Filter.....	HC-5504
Oil Filter Full Flow.....	C-5522
950H (LOADERS) w/C7 Eng.	
Hydraulic Oil Filter.....	HC-55280
950A (LOADERS) S/N: 81J1-4272	
Air Filter Set.....	A-5507-S
Air Filter Primary.....	A-5507
Air Filter Secondary.....	A-5508
Air Filter Set.....	A-55071-S
Air Filter Secondary.....	A-5567
Air Filter Primary.....	A-5566
Air Filter Set.....	A-5568-S
Fuel Filter Secondary.....	FC-5507
Hydraulic Oil Filter.....	H-5504
Hydraulic Oil Filter.....	H-5503
Oil Filter Full Flow.....	O-5502
950A (LOADERS) S/N: 81J4273-7845	
Air Filter Set.....	A-5568-S

MODEL/APPLICATION	SAKURA NO
CATERPILLAR	
Air Filter Primary.....	A-5566
Air Filter Secondary.....	A-5567
Air Filter Set.....	A-55071-S
Air Filter Secondary.....	A-5508
Air Filter Primary.....	A-5507
Air Filter Set.....	A-5507-S
Fuel Filter Secondary.....	FC-5507
Hydraulic Oil Filter.....	H-5503
Hydraulic Oil Filter.....	H-5504
Oil Filter Full Flow.....	C-5510
950A (LOADERS) S/N: 81J7846-UP	
Air Filter Set.....	A-5507-S
Air Filter Primary.....	A-5507
Air Filter Secondary.....	A-5508
Air Filter Set.....	A-55071-S
Air Filter Secondary.....	A-5567
Air Filter Primary.....	A-5566
Air Filter Set.....	A-5568-S
Fuel Filter Secondary.....	FC-5507
Hydraulic Oil Filter.....	H-5504
Hydraulic Oil Filter.....	H-5503
Oil Filter Full Flow.....	C-5510
950F SERIES II (LOADERS) CAT (S/N: 4TF1202-9463)	
Fuel Filter.....	FC-5501
Oil Filter Full Flow.....	C-5510
Oil Filter Full Flow.....	C-5522
950F SERIES II (LOADERS) CAT (S/N: 4TF17863-24499)	
Fuel Filter.....	FC-5501
Fuel Filter.....	FC-5516
Fuel Filter Secondary.....	FC-55151
Fuel Filter Secondary.....	FC-5515
Oil Filter Full Flow.....	C-5522
Oil Filter Full Flow.....	C-5510
950F SERIES II (LOADERS) CAT (S/N: 4TF24500-UP)	
Fuel Filter.....	FC-5501
Fuel Filter.....	FC-5508
Fuel Filter Secondary.....	FC-5515
Fuel Filter Secondary.....	FC-55151
Fuel Filter.....	FC-5516
Oil Filter Full Flow.....	C-5510
Oil Filter Full Flow.....	C-5522
950F SERIES II (LOADERS) CAT (S/N: 4TF9464-17862)	
Fuel Filter.....	FC-5501
Fuel Filter.....	FC-5516
Fuel Filter Secondary.....	FC-55151
Fuel Filter Secondary.....	FC-5515
Oil Filter Full Flow.....	C-5522
Oil Filter Full Flow.....	C-5510
950F SERIES II (LOADERS) CAT (S/N: 98Z1-2349)	
Fuel Filter.....	FC-5501
Fuel Filter Secondary.....	FC-5515
Fuel Filter Secondary.....	FC-55151
Fuel Filter.....	FC-5516

Sakura Filter

ENGINE APPLICATION

MODEL/APPLICATION	SAKURA NO	MODEL/APPLICATION	SAKURA NO	MODEL/APPLICATION	SAKURA NO
CATERPILLAR		CATERPILLAR		CATERPILLAR	
950F SERIES II (LOADERS) CAT (S/N: 98Z1-2349) Oil Filter Full Flow..... C-5522		Cabin Air Filter..... CA-55070 Hydraulic Oil Filter..... H-5506		Air Filter Set..... A-5549M-S Air Filter Primary..... A-5549 Air Filter Secondary..... A-5550 Air Filter Primary..... A-5549M Fuel Filter..... F-5505 Fuel Filter Secondary..... FC-5507 Hydraulic Oil Filter..... H-5506 Oil Filter Full Flow..... C-5510	
950F SERIES II (LOADERS) CAT (S/N: 98Z14398-UP) Fuel Filter..... FC-5516 Fuel Filter Secondary..... FC-55151 Fuel Filter Secondary..... FC-5515 Fuel Filter..... FC-5501 Fuel Filter..... FC-5508 Oil Filter Full Flow..... C-5522		950F SERIES II (LOADERS) S/N: 2LM188-UP Air Filter Primary..... A-5549 Air Filter Set..... A-5549M-S Air Filter Primary..... A-5549M Air Filter Secondary..... A-5550 Cabin Air Filter..... CA-55070 Hydraulic Oil Filter..... H-5506		950F SERIES II (LOADERS) S/N: 5SK1990-UP Air Filter Secondary..... A-5550 Air Filter Primary..... A-5549 Air Filter Set..... A-5549M-S Air Filter Primary..... A-5549M Cabin Air Filter..... CA-55070 Hydraulic Oil Filter..... H-5506	
950F SERIES II (LOADERS) CAT (S/N: 98Z8114-8479) Fuel Filter..... FC-5501 Fuel Filter Secondary..... FC-5515 Fuel Filter Secondary..... FC-55151 Fuel Filter..... FC-5516 Oil Filter Full Flow..... C-5522		950F SERIES II (LOADERS) S/N: 2LM1-UP Air Filter Secondary..... A-5550 Air Filter Primary..... A-5549M Air Filter Set..... A-5549M-S Air Filter Primary..... A-5549 Fuel Filter..... FC-5508 Fuel Filter Secondary..... FC-5515 Fuel Filter Secondary..... FC-55151 Fuel Filter..... FC-5516 Fuel Filter..... F-5505 Hydraulic Oil Filter..... H-5506 Oil Filter Full Flow..... C-5510		950F SERIES II (LOADERS) S/N: 5SK743-UP Air Filter Secondary..... A-5550 Air Filter Primary..... A-5549M Air Filter Set..... A-5549M-S Air Filter Primary..... A-5549 Fuel Filter Secondary..... FC-5515 Fuel Filter..... FC-5516 Fuel Filter Secondary..... FC-55151 Fuel Filter..... FC-5508 Hydraulic Oil Filter..... H-5506 Oil Filter Full Flow..... C-5510	
950F SERIES II (LOADERS) CAT (S/N: 98Z8480-14397) Fuel Filter..... FC-5516 Fuel Filter Secondary..... FC-55151 Fuel Filter Secondary..... FC-5515 Fuel Filter..... FC-5501 Fuel Filter..... FC-5508 Oil Filter Full Flow..... C-5522		950F SERIES II (LOADERS) S/N: 4DJ2000-2864 Air Filter Primary..... A-5549 Air Filter Set..... A-5549M-S Air Filter Primary..... A-5549M Air Filter Secondary..... A-5550 Fuel Filter..... F-5505 Fuel Filter..... FC-5516 Fuel Filter Secondary..... FC-55151 Fuel Filter Secondary..... FC-5515 Hydraulic Oil Filter..... H-5506 Oil Filter Full Flow..... C-5510		950F SERIES II (LOADERS) S/N: 8TK1-4489 Air Filter Primary..... A-5549M Air Filter Secondary..... A-5550 Air Filter Primary..... A-5549 Air Filter Set..... A-5549M-S Fuel Filter..... F-5505 Fuel Filter Secondary..... FC-55151 Fuel Filter..... FC-5516 Fuel Filter Secondary..... FC-5515 Fuel Filter..... FC-5508 Hydraulic Oil Filter..... H-5506 Oil Filter Full Flow..... C-5510	
950F SERIES II (LOADERS) CAT S/N: 4TF1-1171 Fuel Filter..... FC-5501		950F SERIES II (LOADERS) S/N: 4DJ2865-3960 Air Filter Secondary..... A-5550 Air Filter Primary..... A-5549M Air Filter Set..... A-5549M-S Air Filter Primary..... A-5549 Fuel Filter..... FC-5508 Fuel Filter Secondary..... FC-5515 Fuel Filter Secondary..... FC-55151 Hydraulic Oil Filter..... H-5506 Oil Filter Full Flow..... C-5510		950F SERIES II (LOADERS) S/N: 8TK1-815 Air Filter Primary..... A-5549M Air Filter Set..... A-5549M-S Air Filter Primary..... A-5549 Air Filter Secondary..... A-5550 Cabin Air Filter..... CA-55070 Hydraulic Oil Filter..... H-5506	
950F SERIES II (LOADERS) CAT S/N: 4TF1172-1172 Fuel Filter..... FC-5501 Oil Filter Full Flow..... C-5510		950F SERIES II (LOADERS) S/N: 4DJ1179-1179 Fuel Filter..... FC-5501 Oil Filter Full Flow..... C-5510		950F SERIES II (LOADERS) S/N: 8TK3231-4187 Air Filter Secondary..... A-5550 Cabin Air Filter..... CA-55070 Hydraulic Oil Filter..... H-5506	
950F SERIES II (LOADERS) CAT S/N: 4TF1173-1178 Fuel Filter..... FC-5501		950F SERIES II (LOADERS) S/N: 4DJ1180-1198 Fuel Filter..... FC-5501		950F SERIES II (LOADERS) S/N: 8TK4188-UP Air Filter Secondary..... A-5550 Cabin Air Filter..... CA-55070 Hydraulic Oil Filter..... H-5506	
950F SERIES II (LOADERS) CAT S/N: 4TF1179-1179 Fuel Filter..... FC-5501 Oil Filter Full Flow..... C-5510		950F SERIES II (LOADERS) S/N: 5SK1-1989 Air Filter Primary..... A-5549 Air Filter Set..... A-5549M-S Air Filter Primary..... A-5549M Air Filter Secondary..... A-5550 Cabin Air Filter..... CA-55070 Hydraulic Oil Filter..... H-5506		950F SERIES II (LOADERS) S/N: 8TK1-742 Air Filter Secondary..... A-5550	
950F SERIES II (LOADERS) CAT S/N: 4TF1180-1198 Fuel Filter..... FC-5501		950F SERIES II (LOADERS) S/N: 5SK1-742 Air Filter Secondary..... A-5550			
950F SERIES II (LOADERS) CAT S/N: 4TF1199-1199 Fuel Filter..... FC-5501 Oil Filter Full Flow..... C-5510					
950F SERIES II (LOADERS) CAT S/N: 4TF1200-1201 Fuel Filter..... FC-5501					
950F SERIES II (LOADERS) S/N: 2LM1-187 Air Filter Secondary..... A-5550 Air Filter Primary..... A-5549M Air Filter Set..... A-5549M-S Air Filter Primary..... A-5549					

MODEL/APPLICATION	SAKURA NO	MODEL/APPLICATION	SAKURA NO	MODEL/APPLICATION	SAKURA NO
CATERPILLAR		CATERPILLAR		CATERPILLAR	
950F SERIES II (LOADERS) S/N: 8TK4188-UP		Air Filter Set.....	A-5568-S	Air Filter Secondary.....	A-5567
950F SERIES II (LOADERS) S/N: 8TK4490-UP		Air Filter Set.....	A-55071-S	Air Filter Primary.....	A-5566
Air Filter Secondary.....	A-5550	Air Filter Secondary.....	A-5508	Air Filter Set.....	A-55071-S
Air Filter Primary.....	A-5549	Air Filter Primary.....	A-5507	Air Filter Secondary.....	A-5508
Air Filter Set.....	A-5549M-S	Fuel Filter Secondary.....	FC-5507	Air Filter Set.....	A-5568-S
Air Filter Primary.....	A-5549M	Hydraulic Oil Filter.....	H-5508	Fuel Filter Secondary.....	FC-5507
Fuel Filter.....	FC-5508	Hydraulic Oil Filter.....	H-5502	Hydraulic Oil Filter.....	H-5508
Fuel Filter Secondary.....	FC-5515	Hydraulic Oil Filter.....	H-5504	Hydraulic Oil Filter.....	H-5502
Fuel Filter.....	FC-5516	Oil Filter Full Flow.....	O-5502	Hydraulic Oil Filter.....	H-5504
Fuel Filter Secondary.....	FC-55151	951B (LOADERS) S/N: 86J1-1991		Oil Filter Full Flow.....	O-5502
Hydraulic Oil Filter.....	H-5506	Air Filter Primary.....	A-5507	Oil Filter Full Flow.....	C-5510
Oil Filter Full Flow.....	C-5510	Air Filter Secondary.....	A-5508	951C (LOADERS) S/N: 86J4042-UP	
950F SERIES II (LOADERS) S/N: 8TK816-3230		Air Filter Set.....	A-55071-S	Air Filter Set.....	A-5568-S
Air Filter Primary.....	A-5549M	Air Filter Set.....	A-5568-S	Air Filter Secondary.....	A-5508
Air Filter Set.....	A-5549M-S	Air Filter Primary.....	A-5566	Air Filter Set.....	A-55071-S
Air Filter Primary.....	A-5549	Air Filter Secondary.....	A-5567	Air Filter Primary.....	A-5566
Air Filter Secondary.....	A-5550	Air Filter Set.....	A-5507-S	Air Filter Secondary.....	A-5567
Cabin Air Filter.....	CA-55070	Fuel Filter Secondary.....	FC-5507	Air Filter Set.....	A-5507-S
Hydraulic Oil Filter.....	H-5506	Hydraulic Oil Filter.....	H-5504	Air Filter Primary.....	A-5507
951 (LOADERS)		Hydraulic Oil Filter.....	H-5502	Fuel Filter Secondary.....	FC-5507
Hydraulic Oil Filter.....	H-55320	Hydraulic Oil Filter.....	H-5508	Hydraulic Oil Filter.....	H-5508
951 (LOADERS) S/N: 69H1-UP		Oil Filter Full Flow.....	O-5502	Hydraulic Oil Filter.....	H-5504
Air Filter Set.....	A-55071-S	951C (LOADERS) S/N: 19H1-UP		Hydraulic Oil Filter.....	H-5502
Air Filter Secondary.....	A-5508	Hydraulic Oil Filter.....	H-55320	Oil Filter Full Flow.....	O-5502
Air Filter Primary.....	A-5507	951C (LOADERS) S/N: 19H1-UP		Oil Filter Full Flow.....	C-5510
Air Filter Set.....	A-5507-S	Air Filter Set.....	A-5568-S	953 (LOADERS) S/N: 20Z1-UP	
Hydraulic Oil Filter.....	H-5508	Air Filter Set.....	A-55071-S	Air Filter Secondary.....	A-5550
Hydraulic Oil Filter.....	H-5502	Air Filter Secondary.....	A-5508	Air Filter Secondary.....	A-5525
Hydraulic Oil Filter.....	H-5504	Air Filter Primary.....	A-5507	Air Filter Primary.....	A-5549M
Oil Filter Full Flow.....	O-5502	Air Filter Set.....	A-5507-S	Air Filter Primary.....	A-5549
951B (LOADERS)		Air Filter Secondary.....	A-5567	Air Filter Primary.....	A-5542
Hydraulic Oil Filter.....	H-55320	Air Filter Primary.....	A-5566	Air Filter Set.....	A-5542-S
951B (LOADERS) S/N: 69H1-1868		Fuel Filter Secondary.....	FC-5507	Air Filter Set.....	A-5549M-S
Air Filter Primary.....	A-5507	Hydraulic Oil Filter.....	H-5508	Fuel Filter.....	FC-5503
Air Filter Secondary.....	A-5508	Hydraulic Oil Filter.....	H-5502	Hydraulic Oil Filter.....	H-5503
Air Filter Set.....	A-55071-S	Hydraulic Oil Filter.....	H-5504	Oil Filter Full Flow.....	C-5505
Air Filter Set.....	A-5568-S	Oil Filter Full Flow.....	C-5510	953 (LOADERS) S/N: 44Z1-UP	
Air Filter Primary.....	A-5566	Oil Filter Full Flow.....	O-5502	Air Filter Primary.....	A-5509
Air Filter Secondary.....	A-5567	951C (LOADERS) S/N: 86J1992-2597		Air Filter Secondary.....	A-5522
Air Filter Set.....	A-5507-S	Air Filter Set.....	A-5568-S	Air Filter Set.....	A-5522-S
Fuel Filter Secondary.....	FC-5507	Air Filter Secondary.....	A-5508	Fuel Filter Secondary.....	FC-5507
Hydraulic Oil Filter.....	H-5504	Air Filter Set.....	A-55071-S	Fuel Filter.....	F-5505
Hydraulic Oil Filter.....	H-5502	Air Filter Primary.....	A-5566	Hydraulic Oil Filter.....	H-5526
Hydraulic Oil Filter.....	H-5508	Air Filter Secondary.....	A-5567	Hydraulic Oil Filter.....	H-55280
Oil Filter Full Flow.....	O-5502	Air Filter Set.....	A-5507-S	Hydraulic Oil Filter.....	H-5503
951B (LOADERS) S/N: 79H1-UP		Air Filter Primary.....	A-5507	Hydraulic Oil Filter.....	H-5506
Air Filter Set.....	A-5507-S	Fuel Filter Secondary.....	FC-5507	Oil Filter Full Flow.....	C-5505
Air Filter Secondary.....	A-5567	Hydraulic Oil Filter.....	H-5504	953 (LOADERS) S/N: 5Z1-UP	
Air Filter Primary.....	A-5566	Hydraulic Oil Filter.....	H-5502	Air Filter Primary.....	A-5509
951B (LOADERS) S/N: 86J2598-4041		Hydraulic Oil Filter.....	H-5508	Air Filter Secondary.....	A-5550
Air Filter Primary.....	A-5507	Oil Filter Full Flow.....	O-5502	Air Filter Set.....	A-5522-S
Air Filter Set.....	A-5507-S	Oil Filter Full Flow.....	C-5510	Air Filter Secondary.....	A-5522
951C (LOADERS) S/N: 86J2598-4041		951C (LOADERS) S/N: 86J2598-4041		Air Filter Primary.....	A-5549
Air Filter Primary.....	A-5507	Air Filter Primary.....	A-5507	Air Filter Primary.....	A-5549M
Air Filter Set.....	A-5507-S	Air Filter Set.....	A-5507-S	Air Filter Set.....	A-5549M-S

MODEL/APPLICATION	SAKURA NO
CATERPILLAR	
953 (LOADERS) S/N: 521-UP	
Air Filter.....	A-5548
Fuel Filter Secondary.....	FC-5507
Hydraulic Oil Filter.....	H-5506
Hydraulic Oil Filter.....	H-5503
Oil Filter Full Flow.....	C-5505
953 (LOADERS) S/N: 63Y1-UP	
Oil Filter Full Flow.....	C-5505
953 (LOADERS) S/N: 73Y1-UP	
Oil Filter Full Flow.....	C-5505
953 (LOADERS) S/N: 76Y1-UP	
Air Filter Primary.....	A-5509
Air Filter Secondary.....	A-5522
Air Filter Set.....	A-5522-S
Fuel Filter Secondary.....	FC-5507
Fuel Filter.....	F-5505
Hydraulic Oil Filter.....	H-55280
Hydraulic Oil Filter.....	H-5526
Hydraulic Oil Filter.....	H-5503
Hydraulic Oil Filter.....	H-5506
Oil Filter Full Flow.....	C-5505
953 (LOADERS) S/N: 77Y1093-UP	
Air Filter Set.....	A-5522-S
Air Filter Secondary.....	A-5522
Air Filter Primary.....	A-5509
Fuel Filter.....	F-5505
Fuel Filter Secondary.....	FC-5507
Hydraulic Oil Filter.....	H-5506
Hydraulic Oil Filter.....	H-5526
Oil Filter Full Flow.....	C-5505
953 (LOADERS) S/N: 77Y1-1092	
Air Filter Secondary.....	A-5522
Air Filter Set.....	A-5522-S
Air Filter Primary.....	A-5509
Fuel Filter.....	F-5505
Fuel Filter Secondary.....	FC-5507
Hydraulic Oil Filter.....	H-5526
Hydraulic Oil Filter.....	H-55280
Hydraulic Oil Filter.....	H-5506
Hydraulic Oil Filter.....	H-5503
Oil Filter Full Flow.....	C-5505
953 (LOADERS) S/N: 78Y1061-UP	
Air Filter Secondary.....	A-5550
Air Filter Primary.....	A-5549M
Air Filter Secondary.....	A-5525
Air Filter Primary.....	A-5549
Air Filter Primary.....	A-5542
Air Filter Set.....	A-5549M-S
Air Filter Set.....	A-5542-S
Fuel Filter.....	FC-5503
Hydraulic Oil Filter.....	H-5503

MODEL/APPLICATION	SAKURA NO
CATERPILLAR	
Oil Filter Full Flow.....	C-5505
953 (LOADERS) S/N: 78Y1-UP	
Air Filter Set.....	A-5522-S
Air Filter Secondary.....	A-5522
Air Filter Primary.....	A-5509
Fuel Filter.....	F-5505
Fuel Filter Secondary.....	FC-5507
Hydraulic Oil Filter.....	H-55280
Hydraulic Oil Filter.....	H-5526
Hydraulic Oil Filter.....	H-5503
Hydraulic Oil Filter.....	H-5506
Oil Filter Full Flow.....	C-5505
953 (LOADERS) S/N: 96H1-UP	
Oil Filter Full Flow.....	C-5505
953 LGP (LOADERS) S/N: 05Z1-UP	
Air Filter Set.....	A-5522-S
Air Filter Secondary.....	A-5522
Air Filter Primary.....	A-5509
Fuel Filter.....	F-5505
Fuel Filter Secondary.....	FC-5507
Hydraulic Oil Filter.....	H-55280
Hydraulic Oil Filter.....	H-5526
Hydraulic Oil Filter.....	H-5503
Hydraulic Oil Filter.....	H-5506
Oil Filter Full Flow.....	C-5505
953 LGP (LOADERS) S/N: 20Z1-266	
Air Filter Primary.....	A-5509
Air Filter Secondary.....	A-5522
Air Filter Set.....	A-5522-S
Fuel Filter Secondary.....	FC-5507
Fuel Filter.....	F-5505
Hydraulic Oil Filter.....	H-5506
Hydraulic Oil Filter.....	H-5506
Hydraulic Oil Filter.....	H-5503
Hydraulic Oil Filter.....	H-5526
Hydraulic Oil Filter.....	H-55280
Oil Filter Full Flow.....	C-5505
953B (LOADERS) S/N: 5MK1-UP	
Air Filter Set.....	A-5568-S
Air Filter Primary.....	A-5566
Air Filter Secondary.....	A-5567
Fuel Filter Secondary.....	FC-5507
Hydraulic Oil Filter.....	H-5503
Hydraulic Oil Filter.....	H-5506
Oil Filter Full Flow.....	C-5510
953C (LOADERS) CAT 3126B	
Air Filter Secondary.....	A-5534
Air Filter Primary.....	A-5535
Air Filter Set.....	A-5573-S
Fuel Filter.....	FC-5517
Hydraulic Oil Filter.....	H-5506
Oil Filter Full Flow.....	C-5510

MODEL/APPLICATION	SAKURA NO
CATERPILLAR	
953C (LOADERS) w/3126B Eng.	
Air Filter Primary.....	A-5535M
Air Filter Set.....	A-5573M-S
Hydraulic Oil Filter.....	HC-55280
953C (LOADERS) W/3116 ENG.	
Air Filter Set.....	A-5573M-S
Air Filter Primary.....	A-5535M
953D (LOADERS)	
Air Filter Primary.....	A-5555
Air Filter Set.....	A-5555-S
Air Filter Secondary.....	A-5556
Fuel Filter.....	FC-5509
Hydraulic Oil Filter.....	H-5526
Hydraulic Oil Filter.....	H-5522
Hydraulic Oil Filter.....	HC-55170
Hydraulic Oil Filter.....	HC-5801
Oil Filter Full Flow.....	C-5516
953D III (LOADERS) S/N: LBP1-UP	
Hydraulic Oil Filter.....	HC-5504
953C WH (LOADERS) w/3126B Eng.	
Air Filter Primary.....	A-5535M
Air Filter Set.....	A-5573M-S
Hydraulic Oil Filter.....	HC-55280
955 (LOADERS)	
Fuel Filter.....	F-5503
955 (LOADERS) S/N: 12A1-8259	
Hydraulic Oil Filter.....	H-5503
Oil Filter Full Flow.....	O-5501
955 (LOADERS) S/N: 13X1-UP	
Air Filter Primary.....	A-5509
Air Filter Set.....	A-5522-S
Air Filter Secondary.....	A-5510
Hydraulic Oil Filter.....	H-5504
Hydraulic Oil Filter.....	H-5506
Oil Filter Full Flow.....	C-5510
955 (LOADERS) S/N: 26A-UP	
Air Filter Primary.....	A-5511
Air Filter Secondary.....	A-5512
Air Filter Set.....	A-5511-S
955 (LOADERS) S/N: 45A-UP	
Air Filter Set.....	A-5511-S
Air Filter Secondary.....	A-5512
Air Filter Primary.....	A-5511
955 (LOADERS) S/N: 57M1-UP	
Air Filter Primary.....	A-5509

Sakura Filter**ENGINE APPLICATION**

MODEL/APPLICATION	SAKURA NO
CATERPILLAR	
955L (LOADERS) w/3304 Eng. Hydraulic Oil Filter.....	H-55320
960F (LOADERS) CAT (S/N: 4TF10150-13336) Fuel Filter..... Fuel Filter Secondary..... Fuel Filter Secondary..... Fuel Filter..... Oil Filter Full Flow.....	FC-5516 FC-5515 FC-55151 FC-5501 C-5522
960F (LOADERS) CAT (S/N: 4TF13337-17862) Fuel Filter Secondary..... Fuel Filter Secondary..... Fuel Filter..... Oil Filter Full Flow.....	FC-55151 FC-5515 FC-5516 C-5522
960F (LOADERS) CAT (S/N: 4TF17863-31504) Fuel Filter..... Fuel Filter Secondary..... Fuel Filter Secondary..... Oil Filter Full Flow.....	FC-5516 FC-5515 FC-55151 C-5522
960F (LOADERS) CAT (S/N: 4TF31505-32564) Fuel Filter..... Oil Filter Full Flow.....	FC-5508 C-5522
960F (LOADERS) CAT (S/N: 4TF32565-UP) Fuel Filter..... Fuel Filter..... Fuel Filter Secondary..... Fuel Filter Secondary..... Oil Filter Full Flow.....	FC-5508 FC-5516 FC-55151 FC-5515 C-5522
960F (LOADERS) CAT (S/N: 98Z17224-21189) Fuel Filter..... Fuel Filter..... Oil Filter Full Flow.....	FC-5501 FC-5508 C-5522
960F (LOADERS) CAT (S/N: 98Z1750-5539) Fuel Filter..... Fuel Filter..... Fuel Filter Secondary..... Fuel Filter Secondary..... Oil Filter Full Flow.....	FC-5516 FC-5501 FC-5515 FC-55151 C-5522
960F (LOADERS) CAT (S/N: 98Z5540-12352) Fuel Filter Secondary..... Fuel Filter Secondary..... Fuel Filter..... Fuel Filter..... Oil Filter Full Flow.....	FC-55151 FC-5515 FC-5501 FC-5516 C-5522
960F (LOADERS) CAT S/N: 98Z12353-17223 Fuel Filter..... Fuel Filter..... Fuel Filter.....	FC-5516 FC-5508 FC-5501

MODEL/APPLICATION	SAKURA NO
CATERPILLAR	
Fuel Filter Secondary..... Fuel Filter Secondary..... Oil Filter Full Flow.....	FC-5515 FC-55151 C-5522
960F (LOADERS) CAT S/N: 98Z21190-UP Fuel Filter Secondary..... Fuel Filter Secondary..... Fuel Filter..... Fuel Filter..... Fuel Filter..... Oil Filter Full Flow.....	FC-55151 FC-5515 FC-5501 FC-5508 FC-5516 C-5522
960F (LOADERS) CAT 3116DITA Hydraulic Oil Filter Suction.....	H-5516
960F (LOADERS) S/N: 1YM1-UP Air Filter Secondary..... Air Filter Set..... Air Filter Primary..... Air Filter Primary..... Fuel Filter Secondary..... Fuel Filter Secondary..... Fuel Filter..... Fuel Filter..... Hydraulic Oil Filter..... Oil Filter Full Flow.....	A-5550 A-5549M-S A-5549 A-5549M FC-5515 FC-55151 FC-5516 FC-5508 H-5506 C-5510
960F (LOADERS) S/N: 4CL1-328 Air Filter Primary..... Air Filter Primary..... Air Filter Set..... Air Filter Secondary..... Cabin Air Filter..... Hydraulic Oil Filter.....	A-5549M A-5549 A-5549M-S A-5550 CA-55070 H-5506
960F (LOADERS) S/N: 4CL1-446 Air Filter Secondary..... Air Filter Set..... Air Filter Primary..... Air Filter Primary..... Fuel Filter..... Fuel Filter..... Fuel Filter..... Fuel Filter..... Fuel Filter Secondary..... Fuel Filter Secondary..... Hydraulic Oil Filter..... Oil Filter Full Flow.....	A-5550 A-5549M-S A-5549 A-5549M F-5505 FC-5508 FC-5516 FC-55151 FC-5515 H-5506 C-5510
960F (LOADERS) S/N: 4CL329-UP Air Filter Primary..... Air Filter Primary..... Air Filter Set..... Air Filter Secondary..... Cabin Air Filter..... Hydraulic Oil Filter.....	A-5549M A-5549 A-5549M-S A-5550 CA-55070 H-5506
960F (LOADERS) S/N: 4CL447-UP Air Filter Secondary.....	A-5550

MODEL/APPLICATION	SAKURA NO
CATERPILLAR	
Air Filter Set..... Air Filter Primary..... Air Filter Primary..... Fuel Filter Secondary..... Fuel Filter Secondary..... Fuel Filter..... Fuel Filter..... Hydraulic Oil Filter..... Oil Filter Full Flow.....	A-5549M-S A-5549 A-5549M FC-5515 FC-55151 FC-5516 FC-5508 H-5506 C-5510
960F (LOADERS) S/N: 6XL1-272 Air Filter Primary..... Air Filter Primary..... Air Filter Set..... Air Filter Secondary..... Fuel Filter Secondary..... Fuel Filter Secondary..... Fuel Filter..... Fuel Filter..... Hydraulic Oil Filter..... Oil Filter Full Flow.....	A-5549M A-5549 A-5549M-S A-5550 FC-55151 FC-5515 FC-5516 F-5505 H-5506 C-5510
960F (LOADERS) S/N: 6XL273-UP Air Filter Secondary..... Air Filter Set..... Air Filter Primary..... Air Filter Primary..... Fuel Filter..... Fuel Filter..... Fuel Filter Secondary..... Fuel Filter Secondary..... Fuel Filter..... Hydraulic Oil Filter..... Oil Filter Full Flow.....	A-5550 A-5549M-S A-5549 A-5549M FC-5516 FC-5508 FC-5515 FC-55151 F-5505 H-5506 C-5510
960F (LOADERS) S/N: 9ZJ1-UP Air Filter Primary..... Air Filter Primary..... Air Filter Set..... Air Filter Secondary..... Fuel Filter Secondary..... Fuel Filter Secondary..... Fuel Filter..... Fuel Filter..... Fuel Filter..... Fuel Filter..... Fuel Filter..... Fuel Filter..... Fuel Filter Secondary..... Hydraulic Oil Filter..... Oil Filter Full Flow.....	A-5549M A-5549 A-5549M-S A-5550 FC-55151 FC-5515 FC-5508 FC-5516 F-5505 FC-5507 H-5506 C-5510
962G (LOADERS) CAT (S/N: 55K1-2283) Fuel Filter Secondary..... Fuel Filter Secondary..... Fuel Filter..... Fuel Filter..... Oil Filter Full Flow.....	FC-55151 FC-5515 FC-5516 FC-5508 C-5522
962G (LOADERS) CAT (S/N: 55K2284-UP) Fuel Filter..... Fuel Filter.....	FC-5508 FC-5516

MODEL/APPLICATION	SAKURA NO
CATERPILLAR	
962G (LOADERS) CAT (S/N: 55K2284-UP)	
Fuel Filter Secondary.....	FC-5515
Fuel Filter Secondary.....	FC-55151
Oil Filter Full Flow.....	C-5522
962G (LOADERS) CAT (S/N: 6JK1-UP)	
Fuel Filter Secondary.....	FC-55151
Fuel Filter Secondary.....	FC-5515
Fuel Filter.....	FC-5516
Fuel Filter.....	FC-5508
Oil Filter Full Flow.....	C-5522
962G (LOADERS) CAT 3126B ATAAC HEUI (S/N: 3BS1-UP)	
Air Filter Secondary.....	A-5550
Fuel Filter Secondary.....	FC-5515
Fuel Filter Secondary.....	FC-55151
Fuel Filter.....	FC-5508
Fuel Filter.....	FC-5516
Hydraulic Oil Filter.....	HC-5504
Hydraulic Oil Filter.....	HC-55170
Hydraulic Oil Filter.....	HC-5505
Oil Filter Full Flow.....	C-5510
962G (LOADERS) CAT 3126B ATAAC HEUI (S/N: 4PW1-UP)	
Air Filter Secondary.....	A-5550
Fuel Filter Secondary.....	FC-55151
Fuel Filter Secondary.....	FC-5515
Fuel Filter.....	FC-5516
Fuel Filter.....	FC-5508
Hydraulic Oil Filter.....	HC-5504
Oil Filter Full Flow.....	C-5510
962G (LOADERS) CAT 3126B ATAAC HEUI (S/N: 5AS1-UP)	
Air Filter Secondary.....	A-5550
Fuel Filter Secondary.....	FC-5515
Fuel Filter Secondary.....	FC-55151
Fuel Filter.....	FC-5508
Fuel Filter.....	FC-5516
Hydraulic Oil Filter.....	HC-5504
Oil Filter Full Flow.....	C-5510
962G (LOADERS) CAT 3126B ATAAC HEUI (S/N: 5RS1-226)	
Air Filter Secondary.....	A-5550
Fuel Filter.....	FC-5516
Fuel Filter.....	FC-5508
Fuel Filter Secondary.....	FC-55151
Fuel Filter Secondary.....	FC-5515
Hydraulic Oil Filter.....	HC-5504
Oil Filter Full Flow.....	C-5510
962G (LOADERS) CAT 3126B ATAAC HEUI (S/N: 5RS227-UP)	
Air Filter Secondary.....	A-5550
Fuel Filter Secondary.....	FC-5515
Fuel Filter Secondary.....	FC-55151
Fuel Filter.....	FC-5508
Fuel Filter.....	FC-5516
Hydraulic Oil Filter.....	HC-5504

MODEL/APPLICATION	SAKURA NO
CATERPILLAR	
Oil Filter Full Flow.....	C-5510
962G (LOADERS) CAT 3126B ATAAC HEUI (S/N: 6EW1-UP)	
Air Filter Secondary.....	A-5550
Fuel Filter Secondary.....	FC-55151
Fuel Filter Secondary.....	FC-5515
Fuel Filter.....	FC-5516
Fuel Filter.....	FC-5508
Hydraulic Oil Filter.....	HC-5504
Oil Filter Full Flow.....	C-5510
962G (LOADERS) CAT 3126B ATAAC HEUI (S/N: 6HW1-UP)	
Air Filter Secondary.....	A-5550
Fuel Filter Secondary.....	FC-5515
Fuel Filter Secondary.....	FC-55151
Fuel Filter.....	FC-5508
Fuel Filter.....	FC-5516
Hydraulic Oil Filter.....	HC-5504
Oil Filter Full Flow.....	C-5510
962G (LOADERS) CAT 3126B ATAAC HEUI (S/N: 7BW1-UP)	
Air Filter Secondary.....	A-5550
Fuel Filter Secondary.....	FC-55151
Fuel Filter Secondary.....	FC-5515
Fuel Filter.....	FC-5516
Fuel Filter.....	FC-5508
Hydraulic Oil Filter.....	HC-5504
Oil Filter Full Flow.....	C-5510
962G (LOADERS) CAT 3126B ATAAC HEUI (S/N: BDP1-UP)	
Air Filter Secondary.....	A-5550
Fuel Filter Secondary.....	FC-5515
Fuel Filter Secondary.....	FC-55151
Fuel Filter.....	FC-5508
Fuel Filter.....	FC-5516
Hydraulic Oil Filter.....	HC-5504
Oil Filter Full Flow.....	C-5510
962G (LOADERS) S/N: 5A51-217	
Air Filter Secondary.....	A-5550
Air Filter.....	A-5584
Air Filter.....	A-25460
Hydraulic Oil Filter.....	HC-5504
962G (LOADERS) S/N: 5A5218-UP	
Air Filter.....	A-5584
Air Filter Secondary.....	A-5550
Air Filter.....	A-25460
Hydraulic Oil Filter.....	HC-5504
962H (LOADERS) CAT S/N: C7C1-UP , 2006-UP	
Cabin Air Filter.....	CA-55070
Fuel Filter.....	FC-5517
Hydraulic Oil Filter.....	HC-5504
Oil Filter Full Flow.....	C-5522
962H (LOADERS) CAT S/N: K6K1-UP , 2006-UP	
Cabin Air Filter.....	CA-55070

MODEL/APPLICATION	SAKURA NO
CATERPILLAR	
Fuel Filter.....	FC-5517
Hydraulic Oil Filter.....	HC-5504
Oil Filter Full Flow.....	C-5522
962H (LOADERS) CAT S/N: KHX1-UP , 2006-UP	
Cabin Air Filter.....	CA-55070
Fuel Filter.....	FC-5517
Hydraulic Oil Filter.....	HC-5504
Oil Filter Full Flow.....	C-5522
962H (LOADERS) CAT S/N: M3G1-UP , 2006-UP	
Cabin Air Filter.....	CA-55070
Fuel Filter.....	FC-5517
Hydraulic Oil Filter.....	HC-5504
Oil Filter Full Flow.....	C-5522
962H (LOADERS) CAT S/N: N4A1-UP , 2006-UP	
Cabin Air Filter.....	CA-55070
Fuel Filter.....	FC-5517
Hydraulic Oil Filter.....	HC-5504
Oil Filter Full Flow.....	C-5522
962H (LOADERS) w/C7 Eng.	
Hydraulic Oil Filter.....	HC-55280
962G II (LOADERS) CAT (S/N: 5GG1-UP)	
Fuel Filter.....	FC-5517
Oil Filter Full Flow.....	C-5522
962G II (LOADERS) CAT (S/N: BMA1-UP)	
Fuel Filter.....	FC-5517
Oil Filter Full Flow.....	C-5522
962G II (LOADERS) S/N: AXS1-UP	
Air Filter Primary.....	A-5558
Air Filter Secondary.....	A-5559
Cabin Air Filter.....	CA-55070
Hydraulic Oil Filter.....	HC-5504
962G II (LOADERS) S/N: AXY1-UP	
Air Filter Secondary.....	A-5559
Air Filter Primary.....	A-5558
Cabin Air Filter.....	CA-55070
Hydraulic Oil Filter.....	HC-5504
962G II (LOADERS) S/N: AYE1-UP	
Air Filter Primary.....	A-5558
Air Filter Secondary.....	A-5559
Air Filter.....	A-25460
Cabin Air Filter.....	CA-55070
Hydraulic Oil Filter.....	HC-5504
Hydraulic Oil Filter.....	HC-55170
Hydraulic Oil Filter.....	HC-5505
962G II (LOADERS) S/N: BAB1-UP	
Air Filter.....	A-25460
Air Filter Secondary.....	A-5559

MODEL/APPLICATION	SAKURA NO	MODEL/APPLICATION	SAKURA NO	MODEL/APPLICATION	SAKURA NO
CATERPILLAR		CATERPILLAR		CATERPILLAR	
962G II (LOADERS) S/N: BAB1-UP		Air Filter Set..... A-5573M-S		Hydraulic Oil Filter..... HC-5506	
Air Filter Primary..... A-5558		Air Filter Primary..... A-5535M		Hydraulic Oil Filter..... HC-5512	
Cabin Air Filter..... CA-55070		963C (LOADERS) CAT (S/N: 4TF29400-UP)		Hydraulic Oil Filter..... HC-5503	
Hydraulic Oil Filter..... HC-5504		Fuel Filter..... FC-5508		Hydraulic Oil Filter..... HC-55290	
962G II (LOADERS) S/N: BAD1-UP		Fuel Filter..... FC-5516		Hydraulic Oil Filter..... H-5506	
Air Filter Primary..... A-5558		Fuel Filter Secondary..... FC-5515		963C (LOADERS) S/N: BBD2911-2911-UP	
Air Filter Secondary..... A-5559		Fuel Filter Secondary..... FC-55151		Air Filter Primary..... A-5535	
Cabin Air Filter..... CA-55070		Oil Filter Full Flow..... C-5522		Air Filter Secondary..... A-5534	
Hydraulic Oil Filter..... HC-5504		963C (LOADERS) CAT (S/N: BMA1-UP)		Air Filter Set..... A-5573-S	
963 (LOADERS)		Fuel Filter..... FC-5517		Hydraulic Oil Filter..... H-5506	
Air Filter Primary..... A-5535M		Oil Filter Full Flow..... C-5522		Hydraulic Oil Filter..... HC-55290	
Air Filter Set..... A-5573M-S		963C (LOADERS) S/N: 2DS1-2562-UP		Hydraulic Oil Filter..... HC-5503	
963 (LOADERS) S/N: 11Z1-UP		Air Filter Set..... A-5573-S		Hydraulic Oil Filter..... HC-5512	
Air Filter Secondary..... A-5502		Air Filter Secondary..... A-5534		Hydraulic Oil Filter..... HC-5506	
Air Filter Primary..... A-5535		Air Filter Primary..... A-5535		Hydraulic Oil Filter..... H-5506	
Air Filter Primary..... A-5501		Hydraulic Oil Filter..... HC-5506		Hydraulic Oil Filter..... HC-5512	
Air Filter Secondary..... A-5534		Hydraulic Oil Filter..... HC-5512		Hydraulic Oil Filter..... HC-5503	
Air Filter Set..... A-5573-S		Hydraulic Oil Filter..... HC-5503		Hydraulic Oil Filter..... HC-55290	
Air Filter..... A-5548		Hydraulic Oil Filter..... HC-55290		Hydraulic Oil Filter..... H-5506	
Fuel Filter Secondary..... FC-5507		Hydraulic Oil Filter..... HC-5503		963C (LOADERS) S/N: BBD2926-2934-UP	
Hydraulic Oil Filter..... H-5506		Hydraulic Oil Filter..... HC-5512		Air Filter Primary..... A-5535	
Hydraulic Oil Filter..... H-55280		Hydraulic Oil Filter..... HC-5506		Air Filter Secondary..... A-5534	
Oil Filter Full Flow..... C-5510		Hydraulic Oil Filter..... HC-5503		Air Filter Set..... A-5573-S	
963 (LOADERS) S/N: 48Z1-UP		Hydraulic Oil Filter..... HC-5512		Hydraulic Oil Filter..... H-5506	
Air Filter Set..... A-5573-S		Hydraulic Oil Filter..... HC-5506		Hydraulic Oil Filter..... HC-55290	
Air Filter Secondary..... A-5534		963C (LOADERS) S/N: 2DS2563-UP		Hydraulic Oil Filter..... HC-5503	
Air Filter Primary..... A-5535		Air Filter Primary..... A-5535		Hydraulic Oil Filter..... HC-5512	
Hydraulic Oil Filter..... H-5503		Air Filter Secondary..... A-5534		Hydraulic Oil Filter..... HC-5503	
Oil Filter Full Flow..... C-5510		Air Filter Set..... A-5573-S		Hydraulic Oil Filter..... HC-55290	
963 (LOADERS) S/N: 6Z1-UP		Hydraulic Oil Filter..... H-5506		Hydraulic Oil Filter..... H-5506	
Air Filter..... A-5548		Hydraulic Oil Filter..... HC-55290		Hydraulic Oil Filter..... HC-5503	
Air Filter Primary..... A-5535		Hydraulic Oil Filter..... HC-5503		Hydraulic Oil Filter..... HC-55290	
Air Filter Secondary..... A-5534		Hydraulic Oil Filter..... HC-5512		Hydraulic Oil Filter..... H-5506	
Air Filter Primary..... A-5501		Hydraulic Oil Filter..... HC-5506		963C (LOADERS) S/N: BBD2935-2942-UP	
Air Filter Secondary..... A-5502		963C (LOADERS) S/N: BBD1-2904-UP		Air Filter Set..... A-5573-S	
Air Filter Set..... A-5573-S		Air Filter Set..... A-5573-S		Air Filter Secondary..... A-5534	
Fuel Filter Secondary..... FC-5507		Air Filter Secondary..... A-5534		Air Filter Primary..... A-5535	
Hydraulic Oil Filter..... H-55280		Hydraulic Oil Filter..... HC-5506		Hydraulic Oil Filter..... HC-5506	
Hydraulic Oil Filter..... H-5506		Hydraulic Oil Filter..... HC-5512		Hydraulic Oil Filter..... HC-5512	
Oil Filter Full Flow..... C-5510		Hydraulic Oil Filter..... HC-5503		Hydraulic Oil Filter..... HC-5503	
963B (LOADERS) S/N: 9BL1-UP		Hydraulic Oil Filter..... H-5506		Hydraulic Oil Filter..... HC-55290	
Air Filter Secondary..... A-5534		Hydraulic Oil Filter..... HC-55290		Hydraulic Oil Filter..... H-5506	
Air Filter Primary..... A-5535		Hydraulic Oil Filter..... HC-5503		Hydraulic Oil Filter..... HC-5503	
Air Filter Set..... A-5573-S		Hydraulic Oil Filter..... HC-5512		Hydraulic Oil Filter..... HC-5512	
Fuel Filter Secondary..... FC-5504		Hydraulic Oil Filter..... HC-5506		Hydraulic Oil Filter..... HC-5506	
Hydraulic Oil Filter..... H-5503		963C (LOADERS) S/N: BBD2905-2905-UP		963C (LOADERS) S/N: BBD2943-2943-UP	
Hydraulic Oil Filter..... H-5506		Air Filter Primary..... A-5535		Air Filter Primary..... A-5535	
Oil Filter Full Flow..... C-5510		Air Filter Secondary..... A-5534		Air Filter Secondary..... A-5534	
963B (LOADERS) W/3116 ENG.		Air Filter Set..... A-5573-S		Air Filter Set..... A-5573-S	
		Hydraulic Oil Filter..... H-5506		Hydraulic Oil Filter..... H-5506	
		Hydraulic Oil Filter..... HC-55290		Hydraulic Oil Filter..... HC-55290	
		Hydraulic Oil Filter..... HC-5503		Hydraulic Oil Filter..... HC-5503	
		Hydraulic Oil Filter..... HC-5512		Hydraulic Oil Filter..... HC-5512	
		Hydraulic Oil Filter..... HC-5506		Hydraulic Oil Filter..... HC-5506	
		963C (LOADERS) S/N: BBD2906-2910-UP		963C (LOADERS) S/N: BBD2944-2945-UP	
		Air Filter Set..... A-5573-S		Air Filter Set..... A-5573-S	
		Air Filter Secondary..... A-5534		Air Filter Secondary..... A-5534	
		Air Filter Primary..... A-5535			

MODEL/APPLICATION	SAKURA NO	MODEL/APPLICATION	SAKURA NO	MODEL/APPLICATION	SAKURA NO
CATERPILLAR		CATERPILLAR		CATERPILLAR	
963C (LOADERS) S/N: BBD2944-2945-UP		Oil Filter Full Flow	C-5522	Air Filter Secondary	A-5550
Air Filter Primary.....	A-5535	966F SERIES II (LOADERS) CAT (S/N: 6NC1-UP)		Air Filter Primary	A-5558
Hydraulic Oil Filter.....	HC-5506	Fuel Filter Secondary.....	FC-5507	Fuel Filter	F-5505
Hydraulic Oil Filter.....	HC-5512	Fuel Filter.....	FC-5509	Fuel Filter Secondary	FC-5507
Hydraulic Oil Filter.....	HC-5503	Oil Filter Full Flow	C-5516	Hydraulic Oil Filter	H-5506
Hydraulic Oil Filter.....	HC-55290	Oil Filter Full Flow	C-5522	Hydraulic Oil Filter	H-5504
Hydraulic Oil Filter.....	H-5506	966F SERIES II (LOADERS) CAT (S/N: UP)		Hydraulic Oil Filter	H-55270
963C (LOADERS) S/N: BBD2946-UP		Fuel Filter.....	FC-5509	Oil Filter Full Flow	C-5510
Air Filter Primary.....	A-5535	Fuel Filter Secondary.....	FC-5507	966 (LOADERS) S/N: 2521-UP	
Air Filter Secondary.....	A-5534	Oil Filter Full Flow	C-5522	Air Filter Primary	A-5509
Air Filter Set.....	A-5573-S	Oil Filter Full Flow	C-5510	Air Filter Set	A-5522-S
Hydraulic Oil Filter.....	H-5506	966F SERIES II (LOADERS) CAT S/N: 08Z57583-68824		Air Filter Secondary	A-5522
Hydraulic Oil Filter.....	HC-55290	Fuel Filter Secondary.....	FC-5507	Fuel Filter	F-5505
Hydraulic Oil Filter.....	HC-5503	Oil Filter Full Flow	C-5510	Fuel Filter	FC-5501
Hydraulic Oil Filter.....	HC-5512	966F SERIES II (LOADERS) CAT S/N: 13Z22389-28099		Hydraulic Oil Filter	H-5506
Hydraulic Oil Filter.....	HC-5506	Fuel Filter Secondary.....	FC-5507	Hydraulic Oil Filter	H-5504
963C (LOADERS) w/3126B Eng.		Oil Filter Full Flow	C-5510	Oil Filter Full Flow	C-5510
Air Filter Primary.....	A-5535M	966F SERIES II (LOADERS) S/N: 15L1665-UP		966 (LOADERS) S/N: 3551-UP	
Air Filter Set.....	A-5573M-S	Air Filter Secondary.....	A-5559	Air Filter Primary	A-5509
Hydraulic Oil Filter.....	HC-55280	Air Filter Primary.....	A-5558	Air Filter Secondary	A-5522
963C (LOADERS) W/3116 ENG.		Cabin Air Filter.....	CA-55070	Air Filter Set	A-5522-S
Air Filter Set.....	A-5573M-S	Hydraulic Oil Filter	H-5506	Fuel Filter	F-5505
Air Filter Primary.....	A-5535M	Hydraulic Oil Filter	H-55270	Fuel Filter	FC-5501
963 LGP (LOADERS) S/N: 21Z1-UP		966F SERIES II (LOADERS) S/N: 15L597-UP		Hydraulic Oil Filter	H-5504
Air Filter Secondary.....	A-5534	Air Filter Primary.....	A-5558	Hydraulic Oil Filter	H-5506
Air Filter Primary.....	A-5501	Air Filter Secondary.....	A-5559	Oil Filter Full Flow	C-5510
Air Filter Secondary.....	A-5502	Air Filter Secondary.....	A-5550	966C (LOADERS) CAT (S/N: 03N97021-UP)	
Air Filter Primary.....	A-5535	Air Filter Set.....	A-5549M-S	Oil Filter Full Flow	C-5510
Air Filter Set.....	A-5573-S	Air Filter Primary.....	A-5549M	966C (LOADERS) CAT (S/N: 47V16712-UP)	
Fuel Filter Secondary.....	FC-5507	Air Filter Primary.....	A-5549	Oil Filter Full Flow	C-5510
Hydraulic Oil Filter.....	H-5506	Fuel Filter.....	F-5505	966C (LOADERS) CAT (S/N: 8TD1317-UP)	
Hydraulic Oil Filter.....	H-5503	Fuel Filter Secondary.....	FC-5507	Fuel Filter	FC-5501
Oil Filter Full Flow.....	C-5510	Hydraulic Oil Filter	H-55270	Fuel Filter Secondary	FC-5507
963C WH (LOADERS) w/3126B Eng.		Hydraulic Oil Filter	H-5506	966C (LOADERS) CAT (S/N: 8TD1-960)	
Air Filter Primary.....	A-5535M	Hydraulic Oil Filter	H-5504	Fuel Filter Secondary	FC-5507
Air Filter Set.....	A-5573M-S	Oil Filter Full Flow	C-5510	Oil Filter Full Flow	C-5510
Hydraulic Oil Filter.....	HC-55280	966F SERIES II (LOADERS) S/N: 8BG2000-2680		Oil Filter Full Flow	C-5522
966F SERIES II (LOADERS) CAT (S/N: 08Z68825-73069)		Air Filter Primary.....	A-5509	966C (LOADERS) CAT (S/N: 8TD961-1316)	
Fuel Filter Secondary.....	FC-5507	Air Filter Secondary.....	A-5522	Fuel Filter Secondary	FC-5507
Fuel Filter.....	FC-5509	Air Filter Set.....	A-5522-S	966C (LOADERS) CAT S/N: 47V15899-16711	
Oil Filter Full Flow.....	C-5510	Fuel Filter Secondary.....	FC-5507	Oil Filter Full Flow	C-5510
966F SERIES II (LOADERS) CAT (S/N: 13Z28100-30333)		Fuel Filter.....	F-5505	966C (LOADERS) CAT S/N: 49V9319-UP	
Fuel Filter Secondary.....	FC-5507	Hydraulic Oil Filter	H-5504	Oil Filter Full Flow	C-5510
Oil Filter Full Flow.....	C-5522	Hydraulic Oil Filter	H-5506	966C (LOADERS) S/N: 18B1016-UP	
Oil Filter Full Flow.....	C-5510	Oil Filter Full Flow	C-5510	Air Filter Primary	A-5509
966F SERIES II (LOADERS) CAT (S/N: 13Z30334-UP)		966F SERIES II (LOADERS) S/N: 9YJ1-UP		Air Filter Set	A-5522-S
Fuel Filter Secondary.....	FC-5507	Air Filter Secondary.....	A-5559	Air Filter Secondary	A-5510
Oil Filter Full Flow.....	C-5510	Air Filter Primary.....	A-5549	Air Filter Primary	A-5549M
966F SERIES II (LOADERS) CAT (S/N: 13Z30334-UP)		Air Filter Primary.....	A-5549M	Air Filter Secondary	A-5510
Fuel Filter Secondary.....	FC-5507	Air Filter Set.....	A-5549M-S		
Oil Filter Full Flow.....	C-5510				

Sakura Filter

ENGINE APPLICATION

MODEL/APPLICATION	SAKURA NO
CATERPILLAR	
966C (LOADERS) S/N: 1881016-UP	
Hydraulic Oil Filter.....	H-5503
Hydraulic Oil Filter.....	H-55270
966C (LOADERS) S/N: 1881-199	
Hydraulic Oil Filter.....	H-5503
966C (LOADERS) S/N: 1881266-UP	
Air Filter Secondary.....	A-5510
Air Filter Set.....	A-5522-S
Air Filter Primary.....	A-5509
Fuel Filter.....	F-5505
Fuel Filter Secondary.....	FC-5507
Hydraulic Oil Filter.....	H-5504
Hydraulic Oil Filter.....	H-5526
Hydraulic Oil Filter.....	H-55280
Hydraulic Oil Filter.....	H-5503
Hydraulic Oil Filter.....	H-55270
Oil Filter Full Flow.....	C-5510
966C (LOADERS) S/N: 188200-1015	
Air Filter Primary.....	A-5509
Air Filter Set.....	A-5522-S
Air Filter Secondary.....	A-5510
Hydraulic Oil Filter.....	H-55270
Hydraulic Oil Filter.....	H-5503
966C (LOADERS) S/N: 188200-1265	
Air Filter Secondary.....	A-5510
Air Filter Set.....	A-5522-S
Air Filter Primary.....	A-5509
Fuel Filter Secondary.....	FC-5507
Fuel Filter.....	F-5505
Hydraulic Oil Filter.....	H-55280
Hydraulic Oil Filter.....	H-5526
Hydraulic Oil Filter.....	H-5504
Hydraulic Oil Filter.....	H-5503
Hydraulic Oil Filter.....	H-55270
Oil Filter Full Flow.....	C-5510
966C (LOADERS) S/N: 188374-UP	
Air Filter Primary.....	A-5549
Air Filter Primary.....	A-5549M
Air Filter Set.....	A-5549M-S
Air Filter Secondary.....	A-5550
Fuel Filter.....	F-5505
Hydraulic Oil Filter.....	H-5504
Oil Filter Full Flow.....	C-5510
966C (LOADERS) S/N: 30K1-1337	
Air Filter Secondary.....	A-5520
Air Filter Secondary.....	A-5559
Air Filter Primary.....	A-5543
Air Filter Primary.....	A-5558
Air Filter Set.....	A-5544-S
Fuel Filter Secondary.....	FC-5507
Hydraulic Oil Filter.....	H-5503

MODEL/APPLICATION	SAKURA NO
CATERPILLAR	
Hydraulic Oil Filter.....	H-5504
Oil Filter Full Flow.....	C-5510
966C (LOADERS) S/N: 30K1338-1400	
Air Filter Primary.....	A-5549M
Air Filter Secondary.....	A-5550
Air Filter Set.....	A-5549M-S
Air Filter Primary.....	A-5549
Air Filter Primary.....	A-5509
Air Filter Set.....	A-5522-S
Air Filter Secondary.....	A-5510
Fuel Filter Secondary.....	FC-5507
Hydraulic Oil Filter.....	H-5504
Hydraulic Oil Filter.....	H-5503
Oil Filter Full Flow.....	O-5502
966C (LOADERS) S/N: 30K1401-UP	
Air Filter Secondary.....	A-5510
Air Filter Set.....	A-5522-S
Air Filter Primary.....	A-5509
Air Filter Primary.....	A-5549
Air Filter Set.....	A-5549M-S
Air Filter Secondary.....	A-5550
Air Filter Primary.....	A-5549M
Fuel Filter Secondary.....	FC-5507
Hydraulic Oil Filter.....	H-5503
Hydraulic Oil Filter.....	H-5504
Oil Filter Full Flow.....	C-5510
966C (LOADERS) S/N: 76J1-4836	
Air Filter Set.....	A-5544-S
Air Filter Primary.....	A-5558
Air Filter Secondary.....	A-5520
Air Filter Secondary.....	A-5559
Air Filter Primary.....	A-5543
Fuel Filter Secondary.....	FC-5507
Hydraulic Oil Filter.....	H-5504
Hydraulic Oil Filter.....	H-5503
Oil Filter Full Flow.....	C-5510
966C (LOADERS) S/N: 76J4837-5269	
Air Filter Primary.....	A-5549M
Air Filter Secondary.....	A-5550
Air Filter Set.....	A-5549M-S
Air Filter Primary.....	A-5549
Air Filter Primary.....	A-5509
Air Filter Set.....	A-5522-S
Air Filter Secondary.....	A-5510
Fuel Filter Secondary.....	FC-5507
Hydraulic Oil Filter.....	H-5503
Hydraulic Oil Filter.....	H-5504
Oil Filter Full Flow.....	C-5510
966C (LOADERS) S/N: 76J5270-UP	
Air Filter Secondary.....	A-5510
Air Filter Set.....	A-5522-S
Air Filter Primary.....	A-5509
Air Filter Primary.....	A-5549
Air Filter Set.....	A-5549M-S

MODEL/APPLICATION	SAKURA NO
CATERPILLAR	
Air Filter Secondary.....	A-5550
Air Filter Primary.....	A-5549M
Fuel Filter Secondary.....	FC-5507
Hydraulic Oil Filter.....	H-5504
Hydraulic Oil Filter.....	H-5503
Oil Filter Full Flow.....	C-5510
966C (LOADERS) S/N: 9KC1-UP	
Air Filter Primary.....	A-5509
Air Filter Set.....	A-5522-S
Air Filter Secondary.....	A-5510
Fuel Filter.....	F-5505
Fuel Filter Secondary.....	FC-5507
Hydraulic Oil Filter.....	H-55270
Hydraulic Oil Filter.....	H-5504
Hydraulic Oil Filter.....	H-5526
Hydraulic Oil Filter.....	H-55280
Hydraulic Oil Filter.....	H-5503
Oil Filter Full Flow.....	C-5510
966C (LOADERS) S/N: TO-30K1337	
Air Filter Primary.....	A-5558
Air Filter Set.....	A-5544-S
Air Filter Primary.....	A-5543
Air Filter Secondary.....	A-5559
Air Filter Secondary.....	A-5520
Fuel Filter Secondary.....	FC-5507
Fuel Filter.....	F-5505
Hydraulic Oil Filter.....	H-5503
Hydraulic Oil Filter.....	H-5504
Oil Filter Full Flow.....	O-5502
966C (LOADERS) S/N: TO-76J4836	
Air Filter Set.....	A-5544-S
Air Filter Primary.....	A-5558
Air Filter Secondary.....	A-5520
Air Filter Secondary.....	A-5559
Air Filter Primary.....	A-5543
Fuel Filter Secondary.....	FC-5507
Fuel Filter.....	F-5505
Hydraulic Oil Filter.....	H-5504
Hydraulic Oil Filter.....	H-5503
Oil Filter Full Flow.....	O-5502
966C (LOADERS) w/3306 Eng.	
Hydraulic Oil Filter.....	H-55320
966D (LOADERS) CAT (Excluding S/N: 0)	
Fuel Filter.....	FC-5501
Oil Filter Full Flow.....	C-5510
966D (LOADERS) CAT (S/N: 0821731-21156)	
Fuel Filter.....	FC-5501
Oil Filter Full Flow.....	C-5510
Oil Filter Full Flow.....	C-5522
966D (LOADERS) CAT (S/N: 08221157-26313)	
Fuel Filter.....	FC-5501

Sakura Filter

ENGINE APPLICATION

MODEL/APPLICATION	SAKURA NO	MODEL/APPLICATION	SAKURA NO	MODEL/APPLICATION	SAKURA NO
CATERPILLAR		CATERPILLAR		CATERPILLAR	
966D (LOADERS) CAT (S/N: 08Z21157-26313) Oil Filter Full Flow..... C-5522		966D (LOADERS) S/N: 94X1-7031 Hydraulic Oil Filter..... H-5504		Hydraulic Oil Filter..... H-5506 Hydraulic Oil Filter..... H-5504 Oil Filter Full Flow..... C-5510	
966D (LOADERS) CAT (S/N: 08Z26314-41501) Fuel Filter Secondary..... FC-5507 Oil Filter Full Flow..... C-5522		966D (LOADERS) S/N: 94X7032-UP Air Filter Primary..... A-5509 Air Filter Secondary..... A-5550 Air Filter Set..... A-5549M-S Air Filter Primary..... A-5549M Air Filter Primary..... A-5549 Air Filter Set..... A-5522-S Air Filter Secondary..... A-5522 Hydraulic Oil Filter..... H-5504 Hydraulic Oil Filter..... H-55270		966F (LOADERS) CAT (S/N: 08Z68825-73069) Fuel Filter..... FC-5509 Fuel Filter Secondary..... FC-5507 Oil Filter Full Flow..... C-5510	
966D (LOADERS) CAT (S/N: 08Z41502-47761) Fuel Filter Secondary..... FC-5507 Oil Filter Full Flow..... C-5510 Oil Filter Full Flow..... C-5522		966D (LOADERS) S/N: 99Y1-3801 Air Filter Secondary..... A-5522 Air Filter Set..... A-5522-S Air Filter Primary..... A-5509 Air Filter..... A-5546 Hydraulic Oil Filter..... H-55270		966F (LOADERS) CAT (S/N: 08Z73070-UP) Fuel Filter..... FC-5509 Fuel Filter Secondary..... FC-5507 Oil Filter Full Flow..... C-5522 Oil Filter Full Flow..... C-5510	
966D (LOADERS) CAT (S/N: 13Z1-6034) Oil Filter Full Flow..... C-5510		966D (LOADERS) S/N: 99Y1-3801 Air Filter Secondary..... A-5522 Air Filter Set..... A-5522-S Air Filter Primary..... A-5509 Air Filter..... A-5546 Hydraulic Oil Filter..... H-55270		966F (LOADERS) CAT (S/N: 13Z28100-30333) Fuel Filter Secondary..... FC-5507 Oil Filter Full Flow..... C-5510 Oil Filter Full Flow..... C-5522	
966D (LOADERS) CAT (S/N: 13Z6035-7247) Fuel Filter..... FC-5501 Oil Filter Full Flow..... C-5510		966D (LOADERS) S/N: 99Y1-5314 Air Filter Primary..... A-5509 Air Filter Set..... A-5522-S Air Filter Secondary..... A-5522 Fuel Filter..... F-5505 Fuel Filter Secondary..... FC-5507 Hydraulic Oil Filter..... H-55270 Hydraulic Oil Filter..... H-5504 Hydraulic Oil Filter..... H-5506 Oil Filter Full Flow..... C-5510		966F (LOADERS) CAT (S/N: 13Z30334-UP) Fuel Filter Secondary..... FC-5507 Oil Filter Full Flow..... C-5510	
966D (LOADERS) CAT (S/N: 13Z7248-9001) Fuel Filter..... FC-5501		966D (LOADERS) S/N: 99Y3802-UP Air Filter Secondary..... A-5522 Air Filter Set..... A-5522-S Air Filter Primary..... A-5509 Hydraulic Oil Filter..... H-55270		966F (LOADERS) CAT (S/N: 08Z57583-68824) Fuel Filter Secondary..... FC-5507 Oil Filter Full Flow..... C-5510	
966D (LOADERS) CAT (S/N: 08Z47762-UP) Fuel Filter Secondary..... FC-5507 Oil Filter Full Flow..... C-5510		966D (LOADERS) S/N: 99Y3803-UP Air Filter Primary..... A-5509 Air Filter..... A-5546 Air Filter Set..... A-5522-S Air Filter Secondary..... A-5522 Hydraulic Oil Filter..... H-55270		966F (LOADERS) CAT (S/N: 13Z22389-28099) Fuel Filter Secondary..... FC-5507 Oil Filter Full Flow..... C-5510	
966D (LOADERS) CAT (S/N: 13Z20084-UP) Fuel Filter Secondary..... FC-5507 Oil Filter Full Flow..... C-5510		966D (LOADERS) S/N: 99Y3802-UP Air Filter Secondary..... A-5522 Air Filter Set..... A-5522-S Air Filter Primary..... A-5509 Hydraulic Oil Filter..... H-55270		966F (LOADERS) S/N: 15L1-1664 Air Filter Primary..... A-5549 Air Filter Primary..... A-5549M Air Filter Set..... A-5549M-S Air Filter Secondary..... A-5550 Cabin Air Filter..... CA-55070 Hydraulic Oil Filter..... H-5506 Hydraulic Oil Filter..... H-55270	
966D (LOADERS) S/N: 3551-UP Air Filter Set..... A-5522-S Air Filter Secondary..... A-5522 Air Filter Primary..... A-5509 Fuel Filter..... F-5505 Fuel Filter Secondary..... FC-5507 Hydraulic Oil Filter..... H-55270 Hydraulic Oil Filter..... H-5504 Hydraulic Oil Filter..... H-5506 Oil Filter Full Flow..... C-5510		966D (LOADERS) S/N: 99Y3803-UP Air Filter Primary..... A-5509 Air Filter..... A-5546 Air Filter Set..... A-5522-S Air Filter Secondary..... A-5522 Hydraulic Oil Filter..... H-55270		966F (LOADERS) S/N: 15L1-506 Air Filter Secondary..... A-5550 Air Filter Set..... A-5549M-S Air Filter Primary..... A-5549M Air Filter Primary..... A-5549 Fuel Filter..... F-5505 Fuel Filter Secondary..... FC-5507 Hydraulic Oil Filter..... H-55270 Hydraulic Oil Filter..... H-5506 Hydraulic Oil Filter..... H-5504 Oil Filter Full Flow..... C-5510	
966D (LOADERS) S/N: 94X1-6488 Air Filter Primary..... A-5509 Air Filter Secondary..... A-5522 Air Filter Set..... A-5522-S Fuel Filter Secondary..... FC-5507 Fuel Filter..... F-5505 Hydraulic Oil Filter..... H-5506 Hydraulic Oil Filter..... H-5504 Hydraulic Oil Filter..... H-55270 Oil Filter Full Flow..... C-5510		966D (LOADERS) w/3306 Eng. Hydraulic Oil Filter..... H-55320		966F (LOADERS) S/N: 4Y61-UP Air Filter Set..... A-5522-S Air Filter Secondary..... A-5550 Air Filter Secondary..... A-5522	
966D (LOADERS) S/N: 94X1-6488 Air Filter Primary..... A-5509 Air Filter Secondary..... A-5522 Air Filter Set..... A-5522-S Fuel Filter Secondary..... FC-5507 Fuel Filter..... F-5505 Hydraulic Oil Filter..... H-5506 Hydraulic Oil Filter..... H-5504 Hydraulic Oil Filter..... H-55270 Oil Filter Full Flow..... C-5510		966E (LOADERS) w/3306 Eng. Hydraulic Oil Filter..... H-55320		966F (LOADERS) S/N: 3XJ01192-UP , 1993 Air Filter Primary..... A-5509 Air Filter Secondary..... A-5522 Air Filter Set..... A-5522-S Hydraulic Oil Filter..... HC-5505	

MODEL/APPLICATION	SAKURA NO	MODEL/APPLICATION	SAKURA NO	MODEL/APPLICATION	SAKURA NO
CATERPILLAR		CATERPILLAR		CATERPILLAR	
966F (LOADERS) S/N: 4Y61-UP Air Filter Primary..... A-5509 Air Filter Primary..... A-5549 Air Filter Primary..... A-5549M Air Filter Set..... A-5549M-S Fuel Filter Secondary..... FC-5507 Fuel Filter..... F-5505 Hydraulic Oil Filter..... H-55270 Hydraulic Oil Filter..... H-5504 Hydraulic Oil Filter..... H-5506 Oil Filter Full Flow..... C-5510		Fuel Filter..... F-5505 Fuel Filter Secondary..... FC-5507 Hydraulic Oil Filter..... HC-5504 Hydraulic Oil Filter..... H-5504 Oil Filter Full Flow..... C-5510 966G (LOADERS) CAT 3306 (S/N: 3Z51-UP) Air Filter Primary..... A-5558 Air Filter Secondary..... A-5559 Fuel Filter Secondary..... FC-5507 Fuel Filter..... F-5505 Hydraulic Oil Filter..... H-5504 Hydraulic Oil Filter..... HC-5504 Oil Filter Full Flow..... C-5510 966G (LOADERS) CAT 3306 (S/N: 8XW1-346-UP) Air Filter Secondary..... A-5559 Air Filter Primary..... A-5558 Fuel Filter..... F-5505 Fuel Filter Secondary..... FC-5507 Hydraulic Oil Filter..... HC-5504 Hydraulic Oil Filter..... H-5504 Hydraulic Oil Filter..... H-5504 Oil Filter Full Flow..... C-5510 966G (LOADERS) CAT 3306 (S/N: 8XW347-UP) Air Filter Primary..... A-5558 Air Filter Secondary..... A-5559 Fuel Filter Secondary..... FC-5507 Fuel Filter..... F-5505 Hydraulic Oil Filter..... H-5504 Hydraulic Oil Filter..... HC-5504 Oil Filter Full Flow..... C-5510 966G (LOADERS) CAT 3306 (S/N: 9RS1-UP) Air Filter Secondary..... A-5559 Air Filter Primary..... A-5558 Fuel Filter..... F-5505 Hydraulic Oil Filter..... H-5504 Hydraulic Oil Filter..... HC-5504 Oil Filter Full Flow..... C-5510 966G (LOADERS) CAT 3306 (S/N: AAH1-UP) Air Filter Primary..... A-5558 Air Filter Secondary..... A-5559 Fuel Filter Secondary..... FC-5507 Fuel Filter..... F-5505 Hydraulic Oil Filter..... H-5504 Hydraulic Oil Filter..... HC-5504 Oil Filter Full Flow..... C-5510 966G (LOADERS) CAT 3306 (S/N: HDH1-UP) Air Filter Secondary..... A-5559 Air Filter Primary..... A-5558 Fuel Filter..... F-5505 Fuel Filter Secondary..... FC-5507 Hydraulic Oil Filter..... HC-5504 Hydraulic Oil Filter..... H-5504		Oil Filter Full Flow..... C-5510 966G (LOADERS) S/N: 3SW1-1689 Air Filter Primary..... A-5558 Air Filter Secondary..... A-5559 Air Filter..... A-5584 Hydraulic Oil Filter..... HC-5504 Hydraulic Oil Filter..... H-55270 966G (LOADERS) S/N: 3SW1690-UP Air Filter..... A-5584 Hydraulic Oil Filter..... H-55270 Hydraulic Oil Filter..... HC-5504 966G (LOADERS) S/N: 3Z51-790 Air Filter..... A-5584 Air Filter Secondary..... A-5559 Air Filter Primary..... A-5558 Hydraulic Oil Filter..... HC-5504 Hydraulic Oil Filter..... H-55270 966G (LOADERS) S/N: 3Z5791-UP Air Filter..... A-5584 Hydraulic Oil Filter..... H-55270 Hydraulic Oil Filter..... HC-5504 966G (LOADERS) S/N: 9RS1-1631 Air Filter Primary..... A-5558 Air Filter..... A-5584 Air Filter Secondary..... A-5559 Hydraulic Oil Filter..... HC-5505 Hydraulic Oil Filter..... HC-55170 Hydraulic Oil Filter..... HC-5504 Hydraulic Oil Filter..... H-55270 966G (LOADERS) S/N: 9RS1632-UP Air Filter Secondary..... A-5559 Air Filter..... A-5584 Air Filter Primary..... A-5558 Hydraulic Oil Filter..... H-55270 Hydraulic Oil Filter..... HC-5504 966G (LOADERS) S/N: HDH1-28 Air Filter Primary..... A-5558 Air Filter..... A-5584 Air Filter Secondary..... A-5559 Hydraulic Oil Filter..... HC-5504 Hydraulic Oil Filter..... H-55270 966G (LOADERS) S/N: HDH29-UP Air Filter..... A-5584 Hydraulic Oil Filter..... H-55270 Hydraulic Oil Filter..... HC-5504 966H (LOADERS) CAT C11 ATAAC , 2006-UP Air Filter Secondary..... A-8103 Cabin Air Filter..... CA-55070	
966F (LOADERS) S/N: 8B61-UP Air Filter Secondary..... A-5550 Air Filter Set..... A-5522-S Air Filter Set..... A-5549M-S Air Filter Primary..... A-5549M Air Filter Primary..... A-5549 Air Filter Primary..... A-5509 Air Filter Secondary..... A-5522 Fuel Filter..... F-5505 Fuel Filter..... FC-5501 Hydraulic Oil Filter..... H-5506 Hydraulic Oil Filter..... H-5504 Oil Filter Full Flow..... C-5510		966G (LOADERS) S/N: 9YJ1-1984 Air Filter Primary..... A-5549 Air Filter Primary..... A-5549M Air Filter Set..... A-5549M-S Air Filter Secondary..... A-5550 Fuel Filter..... F-5505 Hydraulic Oil Filter..... H-5504 Hydraulic Oil Filter..... H-5506 Oil Filter Full Flow..... C-5510		966G (LOADERS) 08Z1-0N Oil Filter Full Flow..... C-5506	
966G (LOADERS) CAT (S/N: 6NC1-UP) Fuel Filter Secondary..... FC-5507 Fuel Filter..... FC-5509 Oil Filter Full Flow..... C-5522 Oil Filter Full Flow..... C-5516		966G (LOADERS) CAT 3306 (S/N: 3PW1-UP) Air Filter Primary..... A-5558 Air Filter Secondary..... A-5559 Fuel Filter Secondary..... FC-5507 Fuel Filter..... F-5505 Hydraulic Oil Filter..... H-5504 Hydraulic Oil Filter..... HC-5504 Oil Filter Full Flow..... C-5510		966G (LOADERS) CAT 3306 (S/N: 3SW1-UP) Air Filter Secondary..... A-5559 Air Filter Primary..... A-5558	

Sakura Filter

ENGINE APPLICATION

MODEL/APPLICATION	SAKURA NO	MODEL/APPLICATION	SAKURA NO	MODEL/APPLICATION	SAKURA NO
CATERPILLAR		CATERPILLAR		CATERPILLAR	
966H (LOADERS) CAT C11 ATAAC , 2006-UP		Air Filter Set.....	A-5555-S	970F (LOADERS) CAT 3196 ATAAC-EUI (S/N: 7SK1-UP)	
Fuel Filter.....	FC-5517	Fuel Filter.....	FC-5517	Air Filter Secondary.....	A-5559
966H (LOADERS) CAT S/N: A6D1-UP		Hydraulic Oil Filter.....	H-5504	Air Filter Primary.....	A-5558
Air Filter Secondary.....	A-8103	Hydraulic Oil Filter.....	H-55270	Fuel Filter Secondary.....	FC-5507
Cabin Air Filter.....	CA-55070	Hydraulic Oil Filter.....	HC-5504	Fuel Filter.....	F-5505
Fuel Filter.....	FC-5517	Oil Filter Full Flow.....	C-5516	Hydraulic Oil Filter.....	H-5504
966H (LOADERS) CAT S/N: A6G1-UP		966G SERIES II (LOADERS) CAT S/N: AN1-UP		Hydraulic Oil Filter.....	HC-5504
Air Filter Secondary.....	A-8103	Air Filter Set.....	A-5555-S	Hydraulic Oil Filter.....	H-55270
Cabin Air Filter.....	CA-55070	Air Filter Secondary.....	A-5556	Oil Filter Full Flow.....	C-5510
Fuel Filter.....	FC-5517	Air Filter Primary.....	A-5555	970F (LOADERS) CAT 3196 ATAAC-EUI (S/N: 9JK1-UP)	
966H (LOADERS) CAT S/N: RSX1-UP		Cabin Air Filter.....	CA-55070	Air Filter Primary.....	A-5558
Air Filter Secondary.....	A-8103	Hydraulic Oil Filter.....	HC-5504	Air Filter Secondary.....	A-5559
Cabin Air Filter.....	CA-55070	Hydraulic Oil Filter.....	H-55270	Fuel Filter.....	F-5505
Fuel Filter.....	FC-5517	966G SERIES II (LOADERS) CAT S/N: AN21-UP		Fuel Filter Secondary.....	FC-5507
966H (LOADERS) w/C11 Eng.		Air Filter Primary.....	A-5555	Hydraulic Oil Filter.....	H-5504
Hydraulic Oil Filter.....	HC-55280	Air Filter Secondary.....	A-5556	Hydraulic Oil Filter.....	H-55270
966A (LOADERS) S/N: 33A1-UP		Air Filter Set.....	A-5555-S	Hydraulic Oil Filter.....	HC-5504
Air Filter Set.....	A-5522-S	Cabin Air Filter.....	CA-55070	Oil Filter Full Flow.....	C-5510
Air Filter Secondary.....	A-5510	Hydraulic Oil Filter.....	H-55270	970F (LOADERS) CAT S/N: 08Z70280-UP	
Air Filter Primary.....	A-5509	Hydraulic Oil Filter.....	H-55270	Fuel Filter Secondary.....	FC-5507
Air Filter Secondary.....	A-5550	Hydraulic Oil Filter.....	HC-55170	Oil Filter Full Flow.....	C-5522
Air Filter Set.....	A-5549M-S	Hydraulic Oil Filter.....	HC-5505	Oil Filter Full Flow.....	C-5510
Air Filter Primary.....	A-5549M	966R (LOADERS) S/N: 58Z1-UP		970F (LOADERS) CAT S/N: 13Z28100-UP	
Air Filter Primary.....	A-5549	Fuel Filter.....	F-5505	Fuel Filter Secondary.....	FC-5507
Fuel Filter.....	F-5501	Fuel Filter Secondary.....	FC-5507	Oil Filter Full Flow.....	C-5510
Hydraulic Oil Filter.....	H-5503	Hydraulic Oil Filter.....	H-55270	Oil Filter Full Flow.....	C-5522
Oil Filter Full Flow.....	0-5502	Hydraulic Oil Filter.....	H-5526	970F (LOADERS) S/N: 9JK1-491	
966A (LOADERS) S/N: 75A1-UP		Hydraulic Oil Filter.....	H-55280	Air Filter Primary.....	A-5558
Air Filter Primary.....	A-5549	Hydraulic Oil Filter.....	H-5504	Air Filter Secondary.....	A-5559
Air Filter Primary.....	A-5549M	Hydraulic Oil Filter.....	H-5503	Cabin Air Filter.....	CA-55070
Air Filter Set.....	A-5549M-S	Oil Filter Full Flow.....	C-5510	Hydraulic Oil Filter.....	H-55270
Air Filter Secondary.....	A-5550	970F (LOADERS) CAT (S/N: 6NC1-UP)		Hydraulic Oil Filter.....	H-5506
Air Filter Primary.....	A-5509	Fuel Filter Secondary.....	FC-5507	Hydraulic Oil Filter.....	H-5504
Air Filter Secondary.....	A-5510	Fuel Filter.....	FC-5509	970F (LOADERS) S/N: 9JK492-UP	
Air Filter Set.....	A-5522-S	Oil Filter Full Flow.....	C-5522	Air Filter Secondary.....	A-5559
Fuel Filter.....	F-5501	Oil Filter Full Flow.....	C-5516	Air Filter Primary.....	A-5558
Hydraulic Oil Filter.....	H-5503	970F (LOADERS) CAT 3196 ATAAC-EUI (S/N: 7PL1-UP)		Cabin Air Filter.....	CA-55070
Oil Filter Full Flow.....	0-5502	Air Filter Primary.....	A-5558	Hydraulic Oil Filter.....	H-55270
966G SERIES II (LOADERS) CAT (S/N: 3PD1-215)		Air Filter Secondary.....	A-5559	Hydraulic Oil Filter.....	H-5504
Fuel Filter.....	FC-5517	Fuel Filter.....	F-5505	Hydraulic Oil Filter.....	H-5506
Oil Filter Full Flow.....	C-5516	Fuel Filter Secondary.....	FC-5507	972G (LOADERS) CAT (S/N: 6NC1-UP)	
966G SERIES II (LOADERS) CAT (S/N: 3PD216-UP)		Hydraulic Oil Filter.....	H-5504	Fuel Filter.....	FC-5509
Fuel Filter.....	FC-5517	Hydraulic Oil Filter.....	H-55270	Fuel Filter Secondary.....	FC-5507
Oil Filter Full Flow.....	C-5516	Hydraulic Oil Filter.....	HC-5504	Oil Filter Full Flow.....	C-5516
966G SERIES II (LOADERS) CAT 3176C ATAAC EUI (S/N: AXJ1-UP)		Oil Filter Full Flow.....	C-5510	Oil Filter Full Flow.....	C-5522
Air Filter Primary.....	A-5555	970F (LOADERS) S/N: 4WV1-856		972G (LOADERS) S/N: 4WV1-856	
Air Filter Secondary.....	A-5556	Air Filter Primary.....	A-5558		

Sakura Filter

ENGINE APPLICATION

MODEL/APPLICATION	SAKURA NO	MODEL/APPLICATION	SAKURA NO	MODEL/APPLICATION	SAKURA NO
CATERPILLAR		CATERPILLAR		CATERPILLAR	
972G (LOADERS) S/N: 4WV1-856 Air Filter Secondary..... A-5559 Air Filter Primary..... A-5558 Air Filter..... A-5584 Hydraulic Oil Filter..... H-55270 Hydraulic Oil Filter..... HC-5504		972G SERIES II (LOADERS) CAT 3196 ATAAC-EUI (S/N: AXC1-UP) Air Filter Secondary..... A-5556 Air Filter Primary..... A-5555 Air Filter Set..... A-5555-S Fuel Filter..... FC-5517 Hydraulic Oil Filter..... H-55270 Hydraulic Oil Filter..... HC-55170 Hydraulic Oil Filter..... HC-5505 Hydraulic Oil Filter..... HC-5504 Hydraulic Oil Filter..... H-5504 Oil Filter Full Flow..... C-5516		Air Filter Set..... A-5573-S Air Filter Primary..... A-5535 Air Filter..... A-5548 Air Filter Primary..... A-5501 Air Filter Secondary..... A-5534 Air Filter Secondary..... A-5502 Fuel Filter Secondary..... FC-5507 Hydraulic Oil Filter..... H-55280 Hydraulic Oil Filter..... H-5506 Oil Filter Full Flow..... C-5510	
972G (LOADERS) S/N: 4WV857-UP Air Filter..... A-5584 Hydraulic Oil Filter..... HC-5504 Hydraulic Oil Filter..... H-55270		972G SERIES II (LOADERS) CAT 3196 ATAAC-EUI (S/N: AXN1-UP) Air Filter Set..... A-5555-S Air Filter Primary..... A-5555 Air Filter Secondary..... A-5556 Fuel Filter..... FC-5517 Hydraulic Oil Filter..... HC-5504 Hydraulic Oil Filter..... H-55270 Hydraulic Oil Filter..... H-5504 Oil Filter Full Flow..... C-5516		973 (LOADERS) S/N: 9111-UP Air Filter Secondary..... A-5502 Air Filter Secondary..... A-5534 Air Filter Primary..... A-5501 Air Filter..... A-5548 Air Filter Primary..... A-5535 Air Filter Set..... A-5573-S Hydraulic Oil Filter..... H-5506 Hydraulic Oil Filter..... H-5503 Oil Filter Full Flow..... C-5510	
972G (LOADERS) S/N: 7LS1-465 Air Filter..... A-5584 Air Filter Primary..... A-5558 Air Filter Secondary..... A-5559 Hydraulic Oil Filter..... H-55270 Hydraulic Oil Filter..... HC-5504		972G SERIES II (LOADERS) S/N: ANY1-UP Air Filter Secondary..... A-5556 Air Filter Primary..... A-5555 Air Filter Set..... A-5555-S Cabin Air Filter..... CA-55070 Hydraulic Oil Filter..... H-55270 Hydraulic Oil Filter..... HC-5504		973 (LOADERS) w/3306 Eng. Air Filter Set..... A-5573M-S Air Filter Primary..... A-5535M	
972G (LOADERS) S/N: 7LS466-UP Air Filter..... A-5584 Hydraulic Oil Filter..... HC-5504 Hydraulic Oil Filter..... H-55270		972G SERIES II (LOADERS) S/N: AWP1-UP Air Filter Set..... A-5555-S Air Filter Primary..... A-5555 Air Filter Secondary..... A-5556 Cabin Air Filter..... CA-55070 Hydraulic Oil Filter..... H-55270 Hydraulic Oil Filter..... HC-5504		973C (LOADERS) CAT (S/N: 4ZF1-UP) Fuel Filter..... FC-5517	
972H (LOADERS) CAT S/N: A7D1-UP , 2006-UP Air Filter Secondary..... A-8103 Cabin Air Filter..... CA-55070 Fuel Filter..... FC-5510 Fuel Filter..... FC-5517		972G SERIES II (LOADERS) S/N: 3R21-UP Air Filter Set..... A-5555-S Air Filter Primary..... A-5555 Air Filter Secondary..... A-5556 Cabin Air Filter..... CA-55070 Hydraulic Oil Filter..... HC-5504 Hydraulic Oil Filter..... H-55270		973C (LOADERS) CAT (S/N: SAN221-UP) Fuel Filter..... FC-5517	
972H (LOADERS) CAT S/N: A7G1-UP , 2006-UP Air Filter Secondary..... A-8103 Cabin Air Filter..... CA-55070 Fuel Filter..... FC-5517 Fuel Filter..... FC-5510		973 (LOADERS) S/N: 2621-UP Fuel Filter Secondary..... FC-5507 Hydraulic Oil Filter..... H-55280 Hydraulic Oil Filter..... H-5506 Oil Filter Full Flow..... C-5510		973C (LOADERS) CAT (S/N: THY1-UP) Fuel Filter..... FC-5517	
972H (LOADERS) CAT S/N: MHX1-UP , 2006-UP Air Filter Secondary..... A-8103 Cabin Air Filter..... CA-55070 Fuel Filter..... FC-5510 Fuel Filter..... FC-5517		973 (LOADERS) S/N: 3221-UP Air Filter Secondary..... A-5502 Air Filter Secondary..... A-5534 Air Filter Primary..... A-5501 Air Filter..... A-5548 Air Filter Primary..... A-5535 Air Filter Set..... A-5573-S Fuel Filter Secondary..... FC-5507 Hydraulic Oil Filter..... H-5506 Hydraulic Oil Filter..... H-55280 Oil Filter Full Flow..... C-5510		973C (LOADERS) S/N: 3R21-639-UP Air Filter Primary..... A-5535 Air Filter Secondary..... A-5534 Air Filter Set..... A-5573-S Hydraulic Oil Filter..... HC-5503 Hydraulic Oil Filter..... HC-5512 Hydraulic Oil Filter..... HC-5506 Hydraulic Oil Filter..... H-5506	
972H (LOADERS) w/C13 Eng. Hydraulic Oil Filter..... HC-55280		973 (LOADERS) S/N: 321-UP Air Filter Secondary..... A-5502 Air Filter Secondary..... A-5534 Air Filter Primary..... A-5501 Air Filter..... A-5548 Air Filter Primary..... A-5535 Air Filter Set..... A-5573-S Fuel Filter Secondary..... FC-5507 Hydraulic Oil Filter..... H-5506 Hydraulic Oil Filter..... H-55280 Oil Filter Full Flow..... C-5510		973C (LOADERS) S/N: 3R2640-UP Air Filter Set..... A-5573-S Air Filter Secondary..... A-5534 Air Filter Primary..... A-5535 Hydraulic Oil Filter..... H-5506 Hydraulic Oil Filter..... HC-5506 Hydraulic Oil Filter..... HC-5512 Hydraulic Oil Filter..... HC-5503	
972E (PIPE LAYERS) S/N: 65A1-UP Air Filter Primary..... A-5514 Air Filter Set..... A-5514-S Fuel Filter..... F-5501 Hydraulic Oil Filter..... H-5504 Oil Filter Full Flow..... O-5505 Oil Filter Full Flow..... O-5503		973 (LOADERS) S/N: 86G1-UP Air Filter Secondary..... A-5502 Air Filter Secondary..... A-5534 Air Filter Primary..... A-5501 Air Filter..... A-5548 Air Filter Primary..... A-5535 Air Filter Set..... A-5573-S Fuel Filter Secondary..... FC-5507 Hydraulic Oil Filter..... H-5506 Hydraulic Oil Filter..... H-55280 Oil Filter Full Flow..... C-5510		973C (LOADERS) S/N: BCPI-UP Air Filter Primary..... A-5535 Air Filter Secondary..... A-5534 Air Filter Set..... A-5573-S Hydraulic Oil Filter..... HC-5503	

MODEL/APPLICATION	SAKURA NO
CATERPILLAR	
973C (LOADERS) S/N: BCP1-UP	
Hydraulic Oil Filter.....	H-5506
Hydraulic Oil Filter.....	HC-5512
Hydraulic Oil Filter.....	HC-5506
973C (LOADERS) S/N: LDX1-278-UP	
Air Filter Set.....	A-5555-S
Air Filter Secondary.....	A-5556
Air Filter Primary.....	A-5555
Hydraulic Oil Filter.....	H-5506
973C (LOADERS) S/N: LDX279-UP	
Air Filter Primary.....	A-5555
Air Filter Secondary.....	A-5556
Air Filter Set.....	A-5555-S
Hydraulic Oil Filter.....	H-5506
973C (LOADERS) w/3306 Eng.	
Air Filter Primary.....	A-5535M
Air Filter Set.....	A-5573M-S
973C (LOADERS) w/C9 Eng.	
Air Filter Set.....	A-5573M-S
Air Filter Primary.....	A-5535M
Hydraulic Oil Filter.....	HC-55280
973 LGP (LOADERS) S/N: 86G1-UP	
Air Filter Secondary.....	A-5534
Air Filter Primary.....	A-5501
Air Filter Secondary.....	A-5502
Air Filter Primary.....	A-5535
Air Filter Set.....	A-5573-S
Fuel Filter Secondary.....	FC-5507
Hydraulic Oil Filter.....	H-5506
Hydraulic Oil Filter.....	H-5503
Oil Filter Full Flow.....	C-5510
973C WH (LOADERS) w/C9 Eng.	
Air Filter Primary.....	A-5535M
Air Filter Set.....	A-5573M-S
Hydraulic Oil Filter.....	HC-55280
977 (LOADERS) S/N: 10A1-826	
Air Filter Primary.....	A-5507
Air Filter Set.....	A-5507-S
Air Filter Set.....	A-55071-S
Air Filter Secondary.....	A-5508
Oil Filter Full Flow.....	O-5505
Oil Filter Full Flow.....	O-5501
977 (LOADERS) S/N: 10A827-UP	
Air Filter Secondary.....	A-5508
Air Filter Set.....	A-55071-S
Air Filter Set.....	A-5507-S
Air Filter Primary.....	A-5507
Oil Filter Full Flow.....	O-5503

MODEL/APPLICATION	SAKURA NO
CATERPILLAR	
Oil Filter Full Flow.....	O-5501
977 (LOADERS) S/N: 14X1-806	
Air Filter Secondary.....	A-5520
Air Filter Set.....	A-5544-S
Air Filter Primary.....	A-5558
Air Filter Primary.....	A-5543
Air Filter Secondary.....	A-5559
Fuel Filter Secondary.....	FC-5507
Hydraulic Oil Filter.....	H-5503
Hydraulic Oil Filter.....	H-5506
Oil Filter Full Flow.....	C-5510
977 (LOADERS) S/N: 14X807-UP	
Air Filter Primary.....	A-5543
Air Filter Set.....	A-5544-S
Air Filter Secondary.....	A-5520
Hydraulic Oil Filter.....	H-5506
Hydraulic Oil Filter.....	H-5503
Oil Filter Full Flow.....	C-5510
977 (LOADERS) S/N: 20A-20A	
Air Filter Secondary.....	A-5508
Air Filter Set.....	A-5507-S
Air Filter Set.....	A-55071-S
Air Filter Primary.....	A-5507
Hydraulic Oil Filter.....	H-5503
Oil Filter Full Flow.....	O-5501
977H (LOADERS) S/N: 53A1-UP	
Fuel Filter.....	F-5501
Hydraulic Oil Filter.....	H-5503
Oil Filter Full Flow.....	O-5505
Oil Filter Full Flow.....	O-5502
977K (LOADERS) S/N: 11K1-3918	
Air Filter Secondary.....	A-5520
Air Filter Secondary.....	A-5559
Air Filter Primary.....	A-5543
Air Filter Primary.....	A-5558
Air Filter Set.....	A-5544-S
Fuel Filter Secondary.....	FC-5507
Hydraulic Oil Filter.....	H-5503
Oil Filter Full Flow.....	O-5502
977K (LOADERS) S/N: 46H1-UP	
Air Filter Secondary.....	A-5520
Air Filter Set.....	A-5544-S
Air Filter Primary.....	A-5558
Air Filter Primary.....	A-5543
Air Filter Secondary.....	A-5559
Fuel Filter.....	F-5501
Hydraulic Oil Filter.....	H-5503
Oil Filter Full Flow.....	O-5502
977L (LOADERS) S/N: 11K3919-4070	
Fuel Filter Secondary.....	FC-5507
Oil Filter Full Flow.....	C-5510

MODEL/APPLICATION	SAKURA NO
CATERPILLAR	
977L (LOADERS) S/N: 11K4071-UP	
Air Filter Secondary.....	A-5559
Air Filter Primary.....	A-5558
Air Filter Primary.....	A-5543
Air Filter Secondary.....	A-5520
Air Filter Set.....	A-5544-S
Fuel Filter Secondary.....	FC-5507
Hydraulic Oil Filter.....	H-5503
Oil Filter Full Flow.....	C-5510
977L (LOADERS) S/N: 95X1-UP	
Air Filter Set.....	A-5544-S
Air Filter Secondary.....	A-5520
Air Filter Primary.....	A-5543
Air Filter Primary.....	A-5558
Air Filter Secondary.....	A-5559
Fuel Filter Secondary.....	FC-5507
Hydraulic Oil Filter.....	H-5503
Hydraulic Oil Filter.....	H-5506
Oil Filter Full Flow.....	C-5510
980 (LOADERS) S/N: 42H1-UP	
Air Filter Secondary.....	A-5510
Air Filter Set.....	A-5522-S
Air Filter Primary.....	A-5509
Air Filter Primary.....	A-5549
Air Filter Primary.....	A-5549M
Air Filter Set.....	A-5549M-S
Air Filter Secondary.....	A-5550
Fuel Filter.....	F-5501
Hydraulic Oil Filter.....	H-5503
Hydraulic Oil Filter.....	H-5504
Oil Filter Full Flow.....	O-5502
980B (LOADERS) CAT 3306	
Air Filter Primary.....	A-44150
Air Filter Set.....	A-44150-S
980B (LOADERS) S/N: 89P1-1529	
Air Filter.....	A-5546
Air Filter Primary.....	A-5549M
Air Filter Primary.....	A-5549
Air Filter Primary.....	A-5509
Air Filter Set.....	A-5522-S
Air Filter Secondary.....	A-5510
Air Filter Secondary.....	A-5550
Air Filter Set.....	A-5549M-S
Fuel Filter Secondary.....	FC-5507
Hydraulic Oil Filter.....	H-5504
Hydraulic Oil Filter.....	H-5503
Oil Filter Full Flow.....	C-5510
980B (LOADERS) S/N: 89P1530-1878	
Air Filter Primary.....	A-5549
Air Filter Primary.....	A-5549M
Air Filter.....	A-5546
Air Filter Set.....	A-5549M-S

Sakura Filter

ENGINE APPLICATION

MODEL/APPLICATION	SAKURA NO	MODEL/APPLICATION	SAKURA NO	MODEL/APPLICATION	SAKURA NO
CATERPILLAR		CATERPILLAR		CATERPILLAR	
980B (LOADERS) S/N: 89P1530-1878 Air Filter Secondary..... A-5550 Air Filter Secondary..... A-5510 Air Filter Set..... A-5522-S Air Filter Primary..... A-5509 Fuel Filter Secondary..... FC-5507 Hydraulic Oil Filter..... H-5503 Hydraulic Oil Filter..... H-5504 Oil Filter Full Flow..... C-5510		Hydraulic Oil Filter..... H-5503 Hydraulic Oil Filter..... H-5504 Oil Filter Full Flow..... C-5510 980C (LOADERS) CAT 3406 Air Filter Set..... A-44150-S Air Filter Primary..... A-44150 980C (LOADERS) CAT (S/N: 11N1-UP) Fuel Filter..... FC-5509 Fuel Filter..... FC-5519 980C (LOADERS) CAT (S/N: 70V14539-16375) Fuel Filter..... FC-5509 980C (LOADERS) CAT (S/N: 70V16376-UP) Fuel Filter..... FC-5509 980C (LOADERS) S/N: 13B300-UP Air Filter Primary..... A-5501 Air Filter Secondary..... A-5502 Fuel Filter..... FC-5509 Fuel Filter..... F-5505 Hydraulic Oil Filter..... H-5504 Hydraulic Oil Filter..... H-5506 Oil Filter Full Flow..... C-5516 980C (LOADERS) S/N: 2EB1-UP Fuel Filter..... FC-5509 Hydraulic Oil Filter..... H-5506 Hydraulic Oil Filter..... H-5504 Oil Filter Full Flow..... C-5516 980C (LOADERS) S/N: 2XD1-UP Air Filter Secondary..... A-5502 Air Filter Primary..... A-5501 Fuel Filter..... FC-5509 Fuel Filter..... F-5505 Hydraulic Oil Filter..... H-5504 Hydraulic Oil Filter..... H-5506 Hydraulic Oil Filter..... H-55270 Oil Filter Full Flow..... C-5516 980C (LOADERS) S/N: 5XJ1-UP Air Filter Primary..... A-5501 Air Filter Secondary..... A-5502 Fuel Filter..... F-5505 Fuel Filter..... FC-5509 Hydraulic Oil Filter..... H-5506 Hydraulic Oil Filter..... H-5504 Oil Filter Full Flow..... C-5516 980C (LOADERS) S/N: 63X1-2818 Air Filter Secondary..... A-5502 Air Filter Primary..... A-5501 Hydraulic Oil Filter..... H-55270		980C (LOADERS) S/N: 63X1-UP Air Filter Primary..... A-5501 Air Filter Secondary..... A-5502 Air Filter Primary..... A-5535 Air Filter..... A-5546 Air Filter Secondary..... A-5534 Air Filter Set..... A-5573-S Fuel Filter..... F-5505 Fuel Filter..... FC-5519 Hydraulic Oil Filter..... H-5504 Hydraulic Oil Filter..... H-5506 Oil Filter Full Flow..... C-5516 980C (LOADERS) S/N: 63X2819-5062 Air Filter..... A-5546 Air Filter Secondary..... A-5502 Air Filter Primary..... A-5501 Hydraulic Oil Filter..... H-55270 980C (LOADERS) S/N: 63X5063-5184 Air Filter Primary..... A-5501 Air Filter Secondary..... A-5502 Air Filter..... A-5546 Hydraulic Oil Filter..... H-55270 Hydraulic Oil Filter..... H-5506 980C (LOADERS) S/N: 63X5185-6474 Air Filter..... A-5546 Air Filter Secondary..... A-5502 Air Filter Primary..... A-5501 Hydraulic Oil Filter..... H-5506 980C (LOADERS) S/N: 63X6475-6547 Air Filter Primary..... A-5501 Air Filter Secondary..... A-5502 Air Filter..... A-5546 Hydraulic Oil Filter..... H-5506 980C (LOADERS) S/N: 63X6548-6548 Air Filter..... A-5546 Air Filter Secondary..... A-5502 Air Filter Primary..... A-5501 Hydraulic Oil Filter..... H-5506 Hydraulic Oil Filter..... H-5504 Hydraulic Oil Filter..... H-55270 980C (LOADERS) S/N: 63X6549-6574 Air Filter Primary..... A-5501 Air Filter Secondary..... A-5502 Air Filter..... A-5546 Hydraulic Oil Filter..... H-5506 980C (LOADERS) S/N: 63X6575-8791 Air Filter..... A-5546 Air Filter Secondary..... A-5502 Air Filter Primary..... A-5501	
980B (LOADERS) S/N: 89P1539-UP Air Filter Primary..... A-5509 Air Filter Set..... A-5522-S Air Filter Secondary..... A-5510 Air Filter Secondary..... A-5550 Air Filter Set..... A-5549M-S Air Filter..... A-5546 Air Filter Primary..... A-5549M Air Filter Primary..... A-5549 Fuel Filter Secondary..... FC-5507 Hydraulic Oil Filter..... H-5504 Hydraulic Oil Filter..... H-5503 Oil Filter Full Flow..... C-5510					
980B (LOADERS) S/N: 89P1879-4783 Air Filter Secondary..... A-5502 Air Filter Primary..... A-5501 Air Filter Secondary..... A-5534 Air Filter Primary..... A-5535 Air Filter..... A-5546 Air Filter Set..... A-5573-S Fuel Filter Secondary..... FC-5507 Hydraulic Oil Filter..... H-5503 Hydraulic Oil Filter..... H-5504 Oil Filter Full Flow..... C-5510					
980B (LOADERS) S/N: 89P4784-UP Air Filter Primary..... A-5501 Air Filter Secondary..... A-5502 Air Filter Set..... A-5573-S Air Filter..... A-5546 Air Filter Primary..... A-5535 Air Filter Secondary..... A-5534 Fuel Filter Secondary..... FC-5507 Hydraulic Oil Filter..... H-5504 Hydraulic Oil Filter..... H-5503 Oil Filter Full Flow..... C-5510					
980B (LOADERS) S/N: EXC 89P1539-EXC 89P1539 Air Filter Primary..... A-5549 Air Filter..... A-5546 Air Filter Primary..... A-5549M Air Filter Primary..... A-5509 Air Filter Set..... A-5549M-S Air Filter Secondary..... A-5550 Air Filter Secondary..... A-5510 Air Filter Set..... A-5522-S Fuel Filter Secondary..... FC-5507					

Sakura Filter

ENGINE APPLICATION

MODEL/APPLICATION	SAKURA NO	MODEL/APPLICATION	SAKURA NO	MODEL/APPLICATION	SAKURA NO
CATERPILLAR		CATERPILLAR		CATERPILLAR	
980C (LOADERS) S/N: 63X6575-8791 Hydraulic Oil Filter..... H-5506 Hydraulic Oil Filter..... H-5504 Hydraulic Oil Filter..... H-55270		980F (LOADERS) S/N: 3HK721-UP Air Filter Secondary..... A-5534 Air Filter..... A-5546 Air Filter Set..... A-5573-S Air Filter Primary..... A-5535 Hydraulic Oil Filter..... H-5504 Hydraulic Oil Filter..... H-55270		Hydraulic Oil Filter..... H-5506 Hydraulic Oil Filter..... H-5504 Oil Filter Full Flow..... C-5516 980F (LOADERS) S/N: 8CJ541-UP Air Filter Secondary..... A-5534 Air Filter..... A-5546 Air Filter Set..... A-5573-S Air Filter Primary..... A-5535 Hydraulic Oil Filter..... H-5506 Hydraulic Oil Filter..... H-55270	
980C (LOADERS) S/N: 63X8792-8862 Air Filter Primary..... A-5501 Air Filter Secondary..... A-5502 Air Filter..... A-5546 Hydraulic Oil Filter..... H-55270 Hydraulic Oil Filter..... H-5504 Hydraulic Oil Filter..... H-5506		980F (LOADERS) S/N: 3HK-UP Air Filter Primary..... A-5535 Air Filter Primary..... A-5555 Air Filter Set..... A-5555-S Air Filter Set..... A-5573-S Air Filter Secondary..... A-5556 Air Filter Secondary..... A-5534 Air Filter Primary..... A-5501 Air Filter Secondary..... A-5502 Coolant Filter..... WC-5705 Fuel Filter..... FC-5509 Fuel Filter..... FC-5502 Fuel Filter..... F-5505 Hydraulic Oil Filter..... H-5504 Hydraulic Oil Filter..... H-5506 Oil Filter Full Flow..... C-5510		980F (LOADERS) S/N: 8CJ-UP Air Filter Primary..... A-5535 Air Filter Primary..... A-5555 Air Filter Set..... A-5555-S Air Filter Set..... A-5573-S Air Filter Secondary..... A-5556 Air Filter Secondary..... A-5534 Air Filter Primary..... A-5501 Air Filter Secondary..... A-5502 Coolant Filter..... WC-5705 Fuel Filter..... F-5505 Fuel Filter..... FC-5509 Fuel Filter..... FC-5502 Hydraulic Oil Filter..... H-5506 Hydraulic Oil Filter..... H-5504 Oil Filter Full Flow..... C-5510	
980C (LOADERS) S/N: 63X8863-UP Air Filter..... A-5546 Air Filter Secondary..... A-5502 Air Filter Primary..... A-5501 Hydraulic Oil Filter..... H-5506 Hydraulic Oil Filter..... H-5504 Hydraulic Oil Filter..... H-55270		980F (LOADERS) S/N: 5XJ-UP Air Filter Secondary..... A-5502 Air Filter Primary..... A-5501 Air Filter Secondary..... A-5534 Air Filter Secondary..... A-5556 Air Filter Set..... A-5573-S Air Filter Set..... A-5555-S Air Filter Primary..... A-5555 Air Filter Primary..... A-5535 Coolant Filter..... WC-5705 Fuel Filter..... FC-5502 Fuel Filter..... FC-5509 Fuel Filter..... F-5505 Hydraulic Oil Filter..... H-5506 Hydraulic Oil Filter..... H-5504 Oil Filter Full Flow..... C-5510		980F (LOADERS) S/N: 8NJ-UP Air Filter Secondary..... A-5502 Air Filter Primary..... A-5501 Air Filter Secondary..... A-5534 Air Filter Secondary..... A-5556 Air Filter Set..... A-5573-S Air Filter Set..... A-5555-S Air Filter Primary..... A-5555 Air Filter Primary..... A-5535 Coolant Filter..... WC-5705 Fuel Filter..... FC-5502 Fuel Filter..... FC-5509 Fuel Filter..... F-5505 Hydraulic Oil Filter..... H-5504 Hydraulic Oil Filter..... H-5506 Oil Filter Full Flow..... C-5510	
980F (LOADERS) CAT 3406C Air Filter Primary..... A-44150 Air Filter Set..... A-44150-S		980F (LOADERS) S/N: 8CJ1-540 Air Filter Primary..... A-5501 Air Filter Secondary..... A-5502 Air Filter..... A-5546 Hydraulic Oil Filter..... H-5506 Hydraulic Oil Filter..... H-55270		980F (LOADERS) S/N: 3406C Engs. Air Filter Set..... A-5573M-S Air Filter Primary..... A-5535M	
980F (LOADERS) CAT (S/N: 11N1-UP) Fuel Filter..... FC-5519 Fuel Filter..... FC-5509 Oil Filter Full Flow..... C-5516		980F (LOADERS) S/N: 8CJ1-UP Air Filter Secondary..... A-5534 Air Filter Secondary..... A-5502 Air Filter Primary..... A-5501 Air Filter Primary..... A-5535 Air Filter Set..... A-5573-S Fuel Filter..... FC-5509 Fuel Filter..... F-5505 Hydraulic Oil Filter..... H-55270 Hydraulic Oil Filter..... H-5504 Hydraulic Oil Filter..... H-5506 Oil Filter Full Flow..... C-5516		980G (LOADERS) CAT (S/N: 4121-UP) Fuel Filter..... FC-5519 Fuel Filter..... FC-5509 Oil Filter Full Flow..... C-5516	
980F (LOADERS) S/N: 3HK1-720 Air Filter..... A-5546 Hydraulic Oil Filter..... H-5504 Hydraulic Oil Filter..... H-55270		980F (LOADERS) S/N: 2KR1-UP Air Filter Set..... A-5573-S Air Filter Primary..... A-5555		980G (LOADERS) CAT 3406C (S/N: 2KR1-UP) Air Filter Set..... A-5573-S Air Filter Primary..... A-5555	
980F (LOADERS) S/N: 3HK1-UP Air Filter Secondary..... A-5534 Air Filter Secondary..... A-5502 Air Filter Primary..... A-5501 Air Filter Primary..... A-5535 Air Filter Set..... A-5573-S Fuel Filter..... FC-5509 Fuel Filter..... F-5505 Hydraulic Oil Filter..... H-55270 Hydraulic Oil Filter..... H-5504 Hydraulic Oil Filter..... H-5506 Oil Filter Full Flow..... C-5516		980F (LOADERS) S/N: 8CJ1-UP Air Filter Secondary..... A-5534 Air Filter Secondary..... A-5502 Air Filter Primary..... A-5501 Air Filter Primary..... A-5535 Air Filter Set..... A-5573-S Fuel Filter..... F-5505 Fuel Filter..... FC-5509 Hydraulic Oil Filter..... H-55270		980G (LOADERS) CAT 3406C (S/N: 2KR1-UP) Air Filter Set..... A-5573-S Air Filter Primary..... A-5555	

MODEL/APPLICATION	SAKURA NO
CATERPILLAR	
980G (LOADERS) CAT 3406C (S/N: 2KR1-UP)	
Air Filter Secondary.....	A-5556
Air Filter Secondary.....	A-5534
Air Filter Primary.....	A-5535
Air Filter Set.....	A-5555-S
Fuel Filter.....	FC-5509
Fuel Filter.....	F-5505
Hydraulic Oil Filter.....	H-5506
Hydraulic Oil Filter.....	H-5504
Oil Filter Full Flow.....	C-5516
980G (LOADERS) CAT 3406C (S/N: 2SR1-650)	
Air Filter Set.....	A-5555-S
Air Filter Primary.....	A-5535
Air Filter Secondary.....	A-5534
Air Filter Secondary.....	A-5556
Air Filter Primary.....	A-5555
Air Filter Set.....	A-5573-S
Fuel Filter.....	F-5505
Fuel Filter.....	FC-5509
Hydraulic Oil Filter.....	H-5504
Hydraulic Oil Filter.....	H-5506
Oil Filter Full Flow.....	C-5516
980G (LOADERS) CAT 3406C (S/N: 2SR651-UP)	
Air Filter Primary.....	A-5555
Air Filter Secondary.....	A-5556
Air Filter Set.....	A-5555-S
Fuel Filter.....	FC-5509
Fuel Filter.....	F-5505
Hydraulic Oil Filter.....	H-5506
Hydraulic Oil Filter.....	H-5504
Oil Filter Full Flow.....	C-5516
980G (LOADERS) CAT 3406C (S/N: 9CM1-UP)	
Air Filter Set.....	A-5573-S
Air Filter Set.....	A-5555-S
Air Filter Primary.....	A-5535
Air Filter Secondary.....	A-5534
Air Filter Secondary.....	A-5556
Air Filter Primary.....	A-5555
Fuel Filter.....	F-5505
Fuel Filter.....	FC-5509
Hydraulic Oil Filter.....	H-5504
Hydraulic Oil Filter.....	H-5506
Oil Filter Full Flow.....	C-5516
980G (LOADERS) CAT 3406E ATAAC EUI (S/N: 2KR1-UP)	
Air Filter Set.....	A-5573-S
Air Filter Primary.....	A-5555
Air Filter Secondary.....	A-5556
Air Filter Secondary.....	A-5534
Air Filter Primary.....	A-5535
Air Filter Set.....	A-5555-S
Fuel Filter.....	FC-5509
Fuel Filter.....	F-5505
Hydraulic Oil Filter.....	H-5506
Hydraulic Oil Filter.....	H-5504

MODEL/APPLICATION	SAKURA NO
CATERPILLAR	
Hydraulic Oil Filter.....	H-55270
Oil Filter Full Flow.....	C-5516
980G (LOADERS) CAT 3406E ATAAC EUI (S/N: 2KR500-UP)	
Air Filter Set.....	A-5555-S
Air Filter Secondary.....	A-5556
Air Filter Primary.....	A-5555
Fuel Filter.....	FC-5509
Hydraulic Oil Filter.....	H-5504
Hydraulic Oil Filter.....	H-5506
Oil Filter Full Flow.....	C-5516
980G (LOADERS) CAT 3406E ATAAC EUI (S/N: 2SR1-UP)	
Air Filter Secondary.....	A-5556
Air Filter Secondary.....	A-5534
Fuel Filter.....	FC-5509
Fuel Filter.....	F-5505
Hydraulic Oil Filter.....	H-5506
Hydraulic Oil Filter.....	H-5504
Hydraulic Oil Filter.....	H-55270
Oil Filter Full Flow.....	C-5516
980G (LOADERS) CAT 3406E ATAAC EUI (S/N: 2SR651-UP)	
Air Filter Set.....	A-5555-S
Air Filter Secondary.....	A-5556
Air Filter Primary.....	A-5555
Fuel Filter.....	F-5505
Fuel Filter.....	FC-5509
Hydraulic Oil Filter.....	H-5504
Hydraulic Oil Filter.....	H-5506
Oil Filter Full Flow.....	C-5516
980G (LOADERS) CAT 3406E ATAAC EUI (S/N: 9CM00714-UP)	
Air Filter Set.....	A-5573-S
Air Filter Primary.....	A-5535
Air Filter Secondary.....	A-5534
Fuel Filter.....	FC-5509
980G (LOADERS) CAT 3406E ATAAC EUI (S/N: 9CM1125-1422)	
Air Filter.....	A-5584
Air Filter Primary.....	A-5555
Air Filter Secondary.....	A-5556
Air Filter Set.....	A-5555-S
Coolant Filter.....	WC-5705
Fuel Filter.....	FC-5509
Hydraulic Oil Filter.....	H-5506
Hydraulic Oil Filter.....	H-5504
Oil Filter Full Flow.....	C-5516
980G (LOADERS) CAT 3406E ATAAC EUI (S/N: 9CM1-UP)	
Air Filter Set.....	A-5573-S
Air Filter Set.....	A-5555-S
Air Filter Primary.....	A-5535
Air Filter Secondary.....	A-5534
Air Filter Secondary.....	A-5556
Air Filter Primary.....	A-5535
Air Filter Set.....	A-5555-S
Fuel Filter.....	FC-5509
Fuel Filter.....	F-5505
Hydraulic Oil Filter.....	H-5506
Hydraulic Oil Filter.....	H-5504

MODEL/APPLICATION	SAKURA NO
CATERPILLAR	
Hydraulic Oil Filter.....	H-5506
Oil Filter Full Flow.....	C-5516
980G (LOADERS) S/N: 2KR1-505	
Air Filter.....	A-5584
Air Filter Secondary.....	A-5534
Air Filter Primary.....	A-5535
Air Filter Set.....	A-5573-S
Hydraulic Oil Filter.....	H-55270
Hydraulic Oil Filter.....	H-5506
980G (LOADERS) S/N: 2KR3565-UP	
Air Filter.....	A-5584
Air Filter Primary.....	A-5555
Air Filter Secondary.....	A-5556
Air Filter Set.....	A-5555-S
Hydraulic Oil Filter.....	H-5506
Hydraulic Oil Filter.....	H-55270
980G (LOADERS) S/N: 2KR506-3564	
Air Filter.....	A-5584
Air Filter Primary.....	A-5535
Air Filter Secondary.....	A-5534
Air Filter Set.....	A-5573-S
Hydraulic Oil Filter.....	H-55270
Hydraulic Oil Filter.....	H-5506
980G (LOADERS) S/N: 9CM1-372	
Air Filter Secondary.....	A-5534
Air Filter Primary.....	A-5535
Air Filter Set.....	A-5573-S
Air Filter.....	A-5584
Hydraulic Oil Filter.....	H-55270
Hydraulic Oil Filter.....	H-5504
Hydraulic Oil Filter.....	H-5506
980G (LOADERS) S/N: 9CM2142-UP	
Air Filter.....	A-5584
Air Filter Secondary.....	A-5556
Air Filter Primary.....	A-5555
Air Filter Set.....	A-5555-S
Hydraulic Oil Filter.....	H-5506
Hydraulic Oil Filter.....	H-5504
Hydraulic Oil Filter.....	H-55270
980G (LOADERS) S/N: 9CM373-2141	
Air Filter Set.....	A-5555-S
Air Filter Primary.....	A-5555
Air Filter Secondary.....	A-5556
Air Filter.....	A-5584
Hydraulic Oil Filter.....	H-55270
Hydraulic Oil Filter.....	H-5504
Hydraulic Oil Filter.....	H-5506
980G (LOADERS) w/3406, 3406C Eng's.	
Air Filter Set.....	A-5573M-S
Air Filter Primary.....	A-5535M

Sakura Filter

ENGINE APPLICATION

MODEL/APPLICATION	SAKURA NO	MODEL/APPLICATION	SAKURA NO	MODEL/APPLICATION	SAKURA NO
CATERPILLAR		CATERPILLAR		CATERPILLAR	
980H (LOADERS) CAT S/N: JMS1-UP , 2007-UP Air Filter Set..... A-5565-S Air Filter Secondary..... A-5563 Air Filter Primary..... A-5564 Cabin Air Filter..... CA-55070 Fuel Filter..... FC-5517		Fuel Filter..... FC-5517 Fuel/Water Separator Secondary... SFC-5504-10 Fuel/Water Separator Secondary.. SFC-5504-10B Oil Filter Full Flow..... C-5516		988 (LOADERS) S/N: 87A9075-UP Air Filter Secondary..... A-5529 Air Filter Set..... A-5521-S Air Filter Primary..... A-5521 Fuel Filter..... F-5501 Hydraulic Oil Filter..... H-5503 Oil Filter Full Flow..... O-5503	
980H (LOADERS) CAT S/N: LHX1-UP , 2007-UP Air Filter Primary..... A-5564 Air Filter Secondary..... A-5563 Air Filter Set..... A-5565-S Cabin Air Filter..... CA-55070 Fuel Filter..... FC-5517		980G SERIES II (LOADERS) CAT 3406E ATAAC EUI (S/N: AWH1-UP) Air Filter Primary..... A-5555 Air Filter Set..... A-5555-S Air Filter Secondary..... A-5556 Fuel Filter..... FC-5517 Hydraulic Oil Filter..... H-5504 Hydraulic Oil Filter..... H-55270 Oil Filter Full Flow..... C-5516		988B (LOADERS) CAT (S/N: 48W1-13172) Fuel Filter..... FC-5509	
980H (LOADERS) CAT S/N: MHG1-UP , 2007-UP Air Filter Set..... A-5565-S Air Filter Secondary..... A-5563 Air Filter Primary..... A-5564 Cabin Air Filter..... CA-55070 Fuel Filter..... FC-5517		980G SERIES II (LOADERS) S/N: AWH1-759 Air Filter..... A-5584 Air Filter Set..... A-5555-S Air Filter Primary..... A-5555 Cabin Air Filter..... CA-55070 Hydraulic Oil Filter..... H-55270		988B (LOADERS) CAT (S/N: 48W13173-26423) Fuel Filter..... FC-5509	
980H (LOADERS) S/N: MHG1-UP Cabin Air Filter..... CA-55160		980G SERIES II (LOADERS) S/N: AWH760-UP Air Filter Primary..... A-5555 Air Filter Set..... A-5555-S Air Filter Secondary..... A-5556 Air Filter..... A-5584 Cabin Air Filter..... CA-55070 Hydraulic Oil Filter..... H-55270		988B (LOADERS) CAT (S/N: 48W26424-UP) Fuel Filter..... FC-5509	
980F SERIES II (LOADERS) CAT (S/N: 11N9825-UP) Fuel Filter..... FC-5509 Oil Filter Full Flow..... C-5516		980G SERIES II (LOADERS) S/N: AXG1-UP Air Filter Primary..... A-5555 Air Filter Set..... A-5555-S Air Filter Secondary..... A-5556 Air Filter..... A-5584 Cabin Air Filter..... CA-55070 Hydraulic Oil Filter..... H-55270		988B (LOADERS) CAT (S/N: 99C9850-UP) Fuel Filter..... FC-5509	
980F SERIES II (LOADERS) S/N: 5XJ617-UP Air Filter Primary..... A-5535 Air Filter Secondary..... A-5534 Air Filter Set..... A-5573-S Fuel Filter..... F-5505 Fuel Filter..... FC-5509 Hydraulic Oil Filter..... H-5504 Hydraulic Oil Filter..... H-55270 Hydraulic Oil Filter..... H-5506 Hydraulic Oil Filter..... H-55270 Hydraulic Oil Filter..... H-5504 Oil Filter Full Flow..... C-5516		980G SERIES II (LOADERS) S/N: AWH760-UP Air Filter Primary..... A-5555 Air Filter Set..... A-5555-S Air Filter Secondary..... A-5556 Air Filter..... A-5584 Cabin Air Filter..... CA-55070 Hydraulic Oil Filter..... H-55270		988B (LOADERS) CAT S/N: 48W8433-UP Air Filter Primary..... A-5521 Air Filter Set..... A-5521-S Air Filter Secondary..... A-5529 Hydraulic Oil Filter..... H-5509	
980F SERIES II (LOADERS) S/N: 8JN1-UP Air Filter Secondary..... A-5534 Air Filter Primary..... A-5535 Air Filter Set..... A-5573-S Fuel Filter..... F-5505 Fuel Filter..... FC-5509 Hydraulic Oil Filter..... H-5506 Hydraulic Oil Filter..... H-55270 Hydraulic Oil Filter..... H-5504 Oil Filter Full Flow..... C-5516		980G SERIES II (LOADERS) S/N: AXG1-UP Air Filter Secondary..... A-5556 Air Filter Set..... A-5555-S Air Filter Primary..... A-5555 Cabin Air Filter..... CA-55070 Cabin Air Filter..... CA-55060 Hydraulic Oil Filter..... H-5504 Hydraulic Oil Filter..... H-55270		988B (LOADERS) CAT S/N: 50W4034-UP Air Filter Secondary..... A-5529 Air Filter Set..... A-5521-S Air Filter Primary..... A-5521 Hydraulic Oil Filter..... H-5509	
980F SERIES II (LOADERS) w/3406, 3406C Engs. Air Filter Set..... A-5573M-S Air Filter Primary..... A-5535M		980G SERIES II (LOADERS) S/N: AWH760-UP Air Filter Primary..... A-5555 Air Filter Set..... A-5555-S Air Filter Secondary..... A-5556 Air Filter..... A-5584 Cabin Air Filter..... CA-55070 Hydraulic Oil Filter..... H-55270		988B (LOADERS) S/N: 50W1-1285 Hydraulic Oil Filter..... H-55270	
980G SERIES II (LOADERS) CAT (S/N: BET1-UP) Fuel Filter..... FC-5509		980G SERIES II (LOADERS) S/N: 6WS02513-UP , 2000-UP Air Filter Secondary..... A-5550 Fuel Filter..... FC-5508 Fuel Filter..... FC-5516 Fuel Filter Secondary..... FC-55151 Fuel Filter Secondary..... FC-5515 Oil Filter Full Flow..... C-5522		988B (LOADERS) S/N: 50W1286-1492 Air Filter Primary..... A-5521 Air Filter Set..... A-5521-S Air Filter Secondary..... A-5529 Hydraulic Oil Filter..... H-55270	
		983 (LOADERS) S/N: 38K1-UP Air Filter Secondary..... A-5526 Air Filter Primary..... A-5557 Air Filter Set..... A-5557-S Fuel Filter Secondary..... FC-5507 Hydraulic Oil Filter..... H-5503 Oil Filter Full Flow..... O-5503		988B (LOADERS) S/N: 50W1493-6040 Air Filter Secondary..... A-5529 Air Filter Set..... A-5521-S Air Filter Primary..... A-5521 Hydraulic Oil Filter..... H-55270	
		983B (LOADERS) S/N: 58X1-UP Air Filter Primary..... A-5501 Air Filter Secondary..... A-5502 Fuel Filter..... FC-5509		988B (LOADERS) S/N: 50W1-UP Air Filter Primary..... A-5521 Air Filter Set..... A-5521-S Air Filter Secondary..... A-5529 Air Filter Secondary..... A-5556 Air Filter Set..... A-5555-S Air Filter Primary..... A-5555 Fuel Filter..... FC-5519	

MODEL/APPLICATION	SAKURA NO	MODEL/APPLICATION	SAKURA NO	MODEL/APPLICATION	SAKURA NO
CATERPILLAR		CATERPILLAR		CATERPILLAR	
988B (LOADERS) S/N: 50W1-UP		Oil Filter Full Flow	C-5516	Air Filter Primary	A-5593
Fuel Filter.....	FC-5509	988F II (LOADERS) S/N: 2ZR1-UP		Air Filter Set	A-5595-S
Hydraulic Oil Filter.....	H-5504	Air Filter Secondary	A-5556	Air Filter Secondary	A-5594
Oil Filter Full Flow	C-5516	Air Filter Set	A-5555-S	Fuel Filter	FC-5510
988B (LOADERS) S/N: 50W6041-8176		Air Filter Primary	A-5555	Fuel Filter	FC-5517
Air Filter Secondary	A-5529	Fuel Filter	FC-5509	Hydraulic Oil Filter	HC-5512
Air Filter Set	A-5521-S	Hydraulic Oil Filter	H-5504	Hydraulic Oil Filter	HC-5504
Air Filter Primary	A-5521	Oil Filter Full Flow	C-5516	Oil Filter Full Flow	C-7906
Hydraulic Oil Filter	H-55270	988G (LOADERS) CAT 3456 ATAAC-EUI (S/N: 2TW1-UP)		988H (LOADERS) CAT S/N: RHX1-UP , 2006-UP	
988B (LOADERS) S/N: 50W8177-8184		Air Filter Secondary	A-5563	Air Filter Secondary	A-5594
Air Filter Secondary	A-5556	Air Filter Set	A-5565-S	Air Filter Set	A-5595-S
Air Filter Primary	A-5555	Air Filter Primary	A-5564	Air Filter Primary	A-5593
Air Filter Set	A-5555-S	Fuel Filter	FC-5509	Air Filter	A-5584
Hydraulic Oil Filter	H-55270	Hydraulic Oil Filter	HC-5504	Fuel Filter	FC-5517
988B (LOADERS) S/N: 50W8185-8224		Hydraulic Oil Filter	HC-5512	Fuel Filter	FC-5510
Air Filter Set	A-5555-S	Oil Filter Full Flow	C-5516	Hydraulic Oil Filter	HC-5504
Air Filter Primary	A-5555	988G (LOADERS) CAT 3456 ATAAC-EUI (S/N: BNH1-UP)		Hydraulic Oil Filter	HC-5512
Air Filter Secondary	A-5556	Air Filter Primary	A-5564	Hydraulic Oil Filter	HC-5512
Air Filter Secondary	A-5529	Air Filter Set	A-5565-S	Oil Filter Full Flow	C-7906
Air Filter Primary	A-5521	Air Filter Secondary	A-5563	988H (LOADERS) CAT C18TA ACERT	
Air Filter Set	A-5521-S	Fuel Filter	FC-5509	Cabin Air Filter	CA-55120
Hydraulic Oil Filter	H-55270	Hydraulic Oil Filter	HC-5512	988A (LOADERS) S/N: 87A1-1308	
988B (LOADERS) S/N: 50W8225-9164		Hydraulic Oil Filter	HC-5504	Air Filter Primary	A-5555
Air Filter Secondary	A-5556	Oil Filter Full Flow	C-5516	Air Filter Set	A-5555-S
Air Filter Primary	A-5555	988G (LOADERS) CAT S/N: 7RC1-1514		Air Filter Set	A-5544-S
Air Filter Secondary	A-5529	Fuel Filter	FC-5509	Air Filter Secondary	A-5556
Air Filter Primary	A-5521	Hydraulic Oil Filter	HC-5512	Air Filter Primary	A-5543
Air Filter Set	A-5521-S	Hydraulic Oil Filter	HC-5504	Air Filter Secondary	A-5520
Hydraulic Oil Filter	H-55270	Oil Filter Full Flow	C-5516	Fuel Filter	F-5501
988B (LOADERS) S/N: 50W9165-UP		988G (LOADERS) CAT S/N: 7RC1515-UP		Hydraulic Oil Filter	H-5503
Air Filter Set	A-5555-S	Fuel Filter	FC-5509	Oil Filter Full Flow	O-5503
Air Filter Primary	A-5555	988G (LOADERS) CAT S/N: BNT10129-UP		988A (LOADERS) S/N: 87A1309-1878	
Air Filter Secondary	A-5556	Fuel Filter	FC-5509	Air Filter Secondary	A-5520
Hydraulic Oil Filter	H-55270	Oil Filter Full Flow	C-5516	Air Filter Primary	A-5543
988B (LOADERS) w/3408 Eng.		988G (LOADERS) CAT S/N: BNT1-10128		Air Filter Secondary	A-5556
Hydraulic Oil Filter	H-55320	Fuel Filter	FC-5509	Air Filter Set	A-5544-S
988F (LOADERS) CAT (S/N: 48W34250-UP)		Oil Filter Full Flow	C-5516	Air Filter Set	A-5555-S
Fuel Filter	FC-5509	988G (LOADERS) S/N: 1NZ1-UP		Air Filter Primary	A-5555
988F (LOADERS) CAT (S/N: 99C9764-UP)		Air Filter Set	A-5565-S	Fuel Filter	F-5501
Fuel Filter	FC-5509	Air Filter Primary	A-5564	Hydraulic Oil Filter	H-5503
988F (LOADERS) S/N: 8YG1-UP		Air Filter	A-5584	Oil Filter Full Flow	O-5503
Air Filter Primary	A-5555	Air Filter Secondary	A-5563	988A (LOADERS) S/N: 87A1879-5627	
Air Filter Set	A-5555-S	Fuel/Water Separator Secondary ..	SFC-5504-10B	Air Filter Set	A-5544-S
Air Filter Secondary	A-5556	Fuel/Water Separator Secondary ...	SFC-5504-10	Air Filter Primary	A-5558
Fuel Filter	F-5505	Hydraulic Oil Filter	HC-5504	Air Filter Primary	A-5543
Fuel Filter	FC-5509	Hydraulic Oil Filter	H-55270	Air Filter Secondary	A-5520
Hydraulic Oil Filter	H-55270	Hydraulic Oil Filter	HC-5503	Air Filter Secondary	A-5559
Hydraulic Oil Filter	H-5509	Hydraulic Oil Filter	HC-5512	Fuel Filter Secondary	FC-5507
Hydraulic Oil Filter	H-5504	Hydraulic Oil Filter	HC-5506	Hydraulic Oil Filter	H-5503
		988H (LOADERS) CAT S/N: BXY1-UP , 2006-UP		Oil Filter Full Flow	O-5503
		Air Filter	A-5584	988A (LOADERS) S/N: 87A5628-UP	
				Air Filter Secondary	A-5520
				Air Filter Primary	A-5543
				Air Filter Primary	A-5558

MODEL/APPLICATION	SAKURA NO	MODEL/APPLICATION	SAKURA NO	MODEL/APPLICATION	SAKURA NO	
CATERPILLAR		CATERPILLAR		CATERPILLAR		
988A (LOADERS) S/N: 87A5628-UP Air Filter Set..... A-5544-S Air Filter Secondary..... A-5559 Fuel Filter Secondary..... FC-5507 Hydraulic Oil Filter..... H-5503 Oil Filter Full Flow..... 0-5503		Hydraulic Oil Filter..... H-5526 Oil Filter Full Flow..... C-5516 990 II (LOADERS) CAT S/N: 3412 TAE1 Cabin Air Filter..... CA-55120 990H (LOADERS) CAT S/N: BWX1-UP , 2006-UP Air Filter Secondary..... A-5556 Air Filter Set..... A-5555-S Air Filter Primary..... A-5555 Fuel Filter..... FC-5510 Hydraulic Oil Filter..... H-5506 Hydraulic Oil Filter..... H-5526 Hydraulic Oil Filter..... H-55280 Hydraulic Oil Filter..... HC-5504 Oil Filter Full Flow..... C-5516		990 SERIES II (LOADERS) CAT S/N: 5JJ251-4076 Fuel Filter..... FC-5509 Oil Filter Full Flow..... C-5516 990 SERIES II (LOADERS) CAT S/N: 5JJ4370-UP Fuel Filter..... FC-5509 Oil Filter Full Flow..... C-5516 990 SERIES II (LOADERS) S/N: BCR1-UP Air Filter Set..... A-5555-S Air Filter Primary..... A-5555 Air Filter Secondary..... A-5556 Fuel/Water Separator Secondary.. SFC-5504-10B Fuel/Water Separator Secondary.. SFC-5504-10 Hydraulic Oil Filter..... H-55280 Hydraulic Oil Filter..... H-5506 Hydraulic Oil Filter..... H-5526		992C (LOADERS) CAT (S/N: 80M1-UP) Fuel Filter..... FC-5509 Fuel Filter..... FC-5517 Oil Filter Full Flow..... C-5516 992C (LOADERS) S/N: 42X1-647 Hydraulic Oil Filter..... H-5526 Hydraulic Oil Filter..... H-5508 Hydraulic Oil Filter..... H-5502 992C (LOADERS) S/N: 42X1-UP Air Filter Secondary..... A-5556 Air Filter Set..... A-5555-S Air Filter Primary..... A-5555 Air Filter Set..... A-5521-S Air Filter Secondary..... A-5529 Air Filter Primary..... A-5521 Fuel Filter..... FC-5509 Hydraulic Oil Filter..... H-5502 Hydraulic Oil Filter..... H-5508 Hydraulic Oil Filter..... H-5503 Oil Filter Full Flow..... C-5516 992C (LOADERS) S/N: 42X648-899 Air Filter Primary..... A-5521 Air Filter Secondary..... A-5529 Air Filter Set..... A-5521-S Hydraulic Oil Filter..... H-5526 Hydraulic Oil Filter..... H-5508 Hydraulic Oil Filter..... H-5502 Hydraulic Oil Filter..... H-55280 992C (LOADERS) S/N: 42X900-UP Air Filter Set..... A-5521-S Air Filter Secondary..... A-5529 Air Filter Primary..... A-5521 Hydraulic Oil Filter..... H-55280 Hydraulic Oil Filter..... H-5502
988A (LOADERS) S/N: 87A8490-UP Air Filter Set..... A-5544-S Air Filter Primary..... A-5543 Air Filter Secondary..... A-5520		990H (LOADERS) CAT S/N: EHX1-2699-UP , 2006-UP Air Filter Primary..... A-5555 Air Filter Set..... A-5555-S Air Filter Secondary..... A-5556 Fuel Filter..... FC-5510 Hydraulic Oil Filter..... HC-5504 Hydraulic Oil Filter..... H-5526 Hydraulic Oil Filter..... H-5506				
988F SERIES II (LOADERS) CAT (S/N: 5XD1-UP) Fuel Filter..... FC-5509 Fuel/Water Separator Secondary.. SFC-5504-10 Fuel/Water Separator Secondary.. SFC-5504-10B		990H (LOADERS) CAT S/N: EHX2700-UP , 2006-UP Air Filter Secondary..... A-5556 Air Filter Set..... A-5555-S Air Filter Primary..... A-5555 Fuel Filter..... FC-5510 Hydraulic Oil Filter..... HC-5504 Hydraulic Oil Filter..... H-55280 Hydraulic Oil Filter..... H-5506 Hydraulic Oil Filter..... H-5526 Oil Filter Full Flow..... C-5516				
988F SERIES II (LOADERS) CAT (S/N: 99C1-UP) Fuel Filter..... FC-5509 Fuel/Water Separator Secondary.. SFC-5504-10B Fuel/Water Separator Secondary.. SFC-5504-10 Oil Filter Full Flow..... C-5516		990H (LOADERS) CAT S/N: EHX2700-UP , 2006-UP Air Filter Secondary..... A-5556 Air Filter Set..... A-5555-S Air Filter Primary..... A-5555 Fuel Filter..... FC-5510 Hydraulic Oil Filter..... HC-5504 Hydraulic Oil Filter..... H-55280 Hydraulic Oil Filter..... H-5506 Hydraulic Oil Filter..... H-5526 Oil Filter Full Flow..... C-5516				
988F SERIES II (LOADERS) S/N: 2ZR1-UP Air Filter Secondary..... A-5556 Air Filter Set..... A-5555-S Air Filter Primary..... A-5555 Hydraulic Oil Filter..... H-5509 Hydraulic Oil Filter..... H-55270 Hydraulic Oil Filter..... HC-5504		990H (LOADERS) CAT S/N: EHX2700-UP , 2006-UP Air Filter Secondary..... A-5556 Air Filter Set..... A-5555-S Air Filter Primary..... A-5555 Fuel Filter..... FC-5510 Hydraulic Oil Filter..... HC-5504 Hydraulic Oil Filter..... H-55280 Hydraulic Oil Filter..... H-5506 Hydraulic Oil Filter..... H-5526 Oil Filter Full Flow..... C-5516				
990 (LOADERS) CAT 3412E HEUI Air Filter Set..... A-5521-S Air Filter Primary..... A-5521 Air Filter Secondary..... A-5529 Fuel Filter..... FC-5519 Hydraulic Oil Filter..... H-5506 Oil Filter Full Flow..... C-5516		990H (LOADERS) CAT C27TA ACERT Cabin Air Filter..... CA-55120				
990 (LOADERS) CAT (S/N: 73W14650-UP) Fuel Filter..... FC-5509 Oil Filter Full Flow..... C-5516		990 SERIES II (LOADERS) CAT (S/N: 5JJ4077-4369) Fuel Filter..... FC-5509				
990 (LOADERS) CAT (S/N: 80M7883-UP) Fuel Filter..... FC-5509 Oil Filter Full Flow..... C-5516		990 SERIES II (LOADERS) CAT (S/N: 80M1-UP) Fuel Filter..... FC-5509 Fuel Filter..... FC-5517 Oil Filter Full Flow..... C-5516				
990 (LOADERS) CAT 3412 TA Cabin Air Filter..... CA-55120		990 SERIES II (LOADERS) CAT 3412E HEUI (S/N: 4FR1-UP) Air Filter Secondary..... A-5556 Air Filter Primary..... A-5555 Air Filter Set..... A-5555-S Fuel Filter..... FC-5509 Hydraulic Oil Filter..... H-5506 Hydraulic Oil Filter..... H-5526 Oil Filter Full Flow..... C-5516				
990 (LOADERS) CAT 3412E HEUI (S/N: 7HK1-UP) Air Filter Primary..... A-5555 Air Filter Set..... A-5555-S Air Filter Secondary..... A-5556 Fuel Filter..... FC-5509 Hydraulic Oil Filter..... H-5506						

Sakura Filter

ENGINE APPLICATION

MODEL/APPLICATION	SAKURA NO	MODEL/APPLICATION	SAKURA NO	MODEL/APPLICATION	SAKURA NO		
CATERPILLAR		CATERPILLAR		CATERPILLAR			
992C (LOADERS) S/N: 42X900-UP Hydraulic Oil Filter..... H-5508 Hydraulic Oil Filter..... H-5526 Hydraulic Oil Filter..... H-55270 Hydraulic Oil Filter..... H-5504		Hydraulic Oil Filter..... H-5504 Hydraulic Oil Filter..... H-55280 992C (LOADERS) w/3412 Eng. Hydraulic Oil Filter..... H-55320 992D (LOADERS) CAT (S/N: 73W13888-UP) Fuel Filter..... FC-5509 Oil Filter Full Flow..... C-5516 992D (LOADERS) CAT (S/N: 80M1-UP) Fuel Filter..... FC-5517 Fuel Filter..... FC-5509 Oil Filter Full Flow..... C-5516 992D (LOADERS) S/N: 7M31-147 Air Filter Set..... A-5521-S Air Filter Primary..... A-5521 Air Filter Secondary..... A-5529 Hydraulic Oil Filter..... H-55280 Hydraulic Oil Filter..... H-55270 Hydraulic Oil Filter..... H-5526 Hydraulic Oil Filter..... H-5504 Hydraulic Oil Filter..... H-5503 Hydraulic Oil Filter..... H-5502 Hydraulic Oil Filter..... H-5508 Hydraulic Oil Filter..... H-5526 Hydraulic Oil Filter..... H-55270 Hydraulic Oil Filter..... H-5504 992C (LOADERS) S/N: 4921-560 Air Filter Set..... A-5521-S Air Filter Secondary..... A-5529 Air Filter Primary..... A-5521 Hydraulic Oil Filter..... H-55280 Hydraulic Oil Filter..... H-5502 Hydraulic Oil Filter..... H-5508 Hydraulic Oil Filter..... H-5526 Hydraulic Oil Filter..... H-55270 Hydraulic Oil Filter..... H-5504 992C (LOADERS) S/N: 4921-UP Air Filter Primary..... A-5521 Air Filter Secondary..... A-5529 Air Filter Set..... A-5521-S Fuel Filter..... FC-5509 Hydraulic Oil Filter..... H-5504 Hydraulic Oil Filter..... H-5503 Hydraulic Oil Filter..... H-5509 Hydraulic Oil Filter..... H-5516 992C (LOADERS) S/N: 492561-977 Air Filter Set..... A-5521-S Air Filter Secondary..... A-5529 Air Filter Primary..... A-5521 Hydraulic Oil Filter..... H-55280 Hydraulic Oil Filter..... H-5504 Hydraulic Oil Filter..... H-55270 Hydraulic Oil Filter..... H-5526 Hydraulic Oil Filter..... H-5508 Hydraulic Oil Filter..... H-5502 992C (LOADERS) S/N: 492978-1175 Air Filter Primary..... A-5521 Air Filter Secondary..... A-5529 Air Filter Set..... A-5521-S Hydraulic Oil Filter..... H-5502 Hydraulic Oil Filter..... H-5508 Hydraulic Oil Filter..... H-5526 Hydraulic Oil Filter..... H-55270		Hydraulic Oil Filter..... H-5504 Hydraulic Oil Filter..... H-55280 992D (LOADERS) S/N: 7M3148-UP Air Filter Primary..... A-5555 Air Filter Set..... A-5555-S Air Filter Secondary..... A-5556 Hydraulic Oil Filter..... H-5509 Hydraulic Oil Filter..... H-5508 Hydraulic Oil Filter..... H-5502 Hydraulic Oil Filter..... H-5503 Hydraulic Oil Filter..... H-5508 Hydraulic Oil Filter..... H-5504 Hydraulic Oil Filter..... H-5526 Hydraulic Oil Filter..... H-55270 Hydraulic Oil Filter..... H-55280 992D (LOADERS) S/N: 7M31-UP Air Filter Secondary..... A-5556 Air Filter Set..... A-5555-S Air Filter Primary..... A-5555 Air Filter Secondary..... A-5529 Air Filter Primary..... A-5521 Air Filter Set..... A-5521-S Fuel Filter..... FC-5509 Hydraulic Oil Filter..... H-5526 Hydraulic Oil Filter..... H-5504 Hydraulic Oil Filter..... H-5503 Hydraulic Oil Filter..... H-5502 Hydraulic Oil Filter..... H-5508 Hydraulic Oil Filter..... H-5509 Hydraulic Oil Filter..... H-55280 Oil Filter Full Flow..... C-5516 992D (LOADERS) S/N: 7M31-UP Air Filter Secondary..... A-5556 Air Filter Set..... A-5555-S Air Filter Primary..... A-5555 Air Filter Secondary..... A-5529 Air Filter Primary..... A-5521 Air Filter Set..... A-5521-S Fuel Filter..... FC-5509 Hydraulic Oil Filter..... H-5526 Hydraulic Oil Filter..... H-5504 Hydraulic Oil Filter..... H-5503 Hydraulic Oil Filter..... H-5502 Hydraulic Oil Filter..... H-5508 Hydraulic Oil Filter..... H-5509 Hydraulic Oil Filter..... H-55280 Oil Filter Full Flow..... C-5516		992D (LOADERS) w/3412 Eng. Hydraulic Oil Filter..... H-55320 992G (LOADERS) CAT (S/N: 2GR1-2632) Air Filter Secondary..... A-44230 Air Filter Primary..... A-44220 Air Filter Set..... A-44240-S Air Filter Secondary..... A-5594 Air Filter Set..... A-5595-S Air Filter Primary..... A-5593 Air Filter Secondary..... A-5715 Fuel Filter..... FC-5510 992G (LOADERS) CAT (S/N: 2GR2633-UP) Air Filter Secondary..... A-5715 Air Filter Primary..... A-5593 Air Filter Set..... A-5595-S Air Filter Secondary..... A-5594 Air Filter Set..... A-44240-S Air Filter Primary..... A-44220 Air Filter Secondary..... A-44230 Fuel Filter..... FC-5510 992G (LOADERS) CAT 3508B EUI (S/N: 7HR1-UP) Air Filter Secondary..... A-44230 Air Filter Primary..... A-44220 Air Filter Set..... A-44240-S Fuel Filter..... FC-5510 Hydraulic Oil Filter..... H-5526 Hydraulic Oil Filter..... HC-5504 Hydraulic Oil Filter..... HC-5512 Oil Filter Full Flow..... C-5516 992G (LOADERS) CAT 3508B EUI (S/N: ADZ1-UP) Air Filter Set..... A-44240-S Air Filter Primary..... A-44220 Air Filter Secondary..... A-44230 Fuel Filter..... FC-5510 Hydraulic Oil Filter..... HC-5512 Hydraulic Oil Filter..... HC-5504 Hydraulic Oil Filter..... H-5526 Oil Filter Full Flow..... C-5516 992G (LOADERS) CAT 3508TA Cabin Air Filter..... CA-55120 992G (LOADERS) S/N: ADZ1-540 Hydraulic Oil Filter..... HC-5512 Hydraulic Oil Filter..... H-5526 Hydraulic Oil Filter..... HC-5504 Hydraulic Oil Filter..... H-55280 992G (LOADERS) S/N: ADZ541-UP Hydraulic Oil Filter..... H-55280 Hydraulic Oil Filter..... HC-5504 Hydraulic Oil Filter..... H-5526	

Sakura Filter

ENGINE APPLICATION

MODEL/APPLICATION	SAKURA NO	MODEL/APPLICATION	SAKURA NO	MODEL/APPLICATION	SAKURA NO
CATERPILLAR		CATERPILLAR		CATERPILLAR	
992G (LOADERS) S/N: AD2541-UP Hydraulic Oil Filter..... HC-5512		Air Filter Set..... A-5521-S Air Filter Primary..... A-5521 Air Filter Secondary..... A-5552 Air Filter Secondary..... A-5556 Air Filter Set..... A-5555-S Air Filter Primary..... A-5555 Fuel Filter..... FC-5510 Hydraulic Oil Filter..... H-5503 Hydraulic Oil Filter..... H-5504 Hydraulic Oil Filter..... H-55280		Fuel Filter..... FC-5510 Hydraulic Oil Filter..... H-5504 Hydraulic Oil Filter..... H-5503 Hydraulic Oil Filter..... HC-5504	
992G (LOADERS) S/N: AZX1-UP Hydraulic Oil Filter..... HC-5512 Hydraulic Oil Filter..... H-5526 Hydraulic Oil Filter..... HC-5504 Hydraulic Oil Filter..... H-55280		994 (LOADERS) S/N: 9YF20-20 Air Filter Secondary..... A-5552 Air Filter Primary..... A-5521 Air Filter Set..... A-5521-S Hydraulic Oil Filter..... HC-5504 Hydraulic Oil Filter..... H-55270 Hydraulic Oil Filter..... H-5526 Hydraulic Oil Filter..... H-55280 Hydraulic Oil Filter..... HC-5508		994 (LOADERS) S/N: 9YF21-27 Air Filter Set..... A-5521-S Air Filter Primary..... A-5521 Air Filter Secondary..... A-5552 Hydraulic Oil Filter..... H-5503 Hydraulic Oil Filter..... HC-5508 Hydraulic Oil Filter..... H-55280 Hydraulic Oil Filter..... H-5526 Hydraulic Oil Filter..... H-55270 Hydraulic Oil Filter..... HC-5504	
992K (LOADERS) CAT C32 ACERT Cabin Air Filter..... CA-55120		994 (LOADERS) S/N: 9Y49-55 Air Filter Primary..... A-5555 Air Filter Set..... A-5555-S Air Filter Secondary..... A-5556 Hydraulic Oil Filter..... HC-5504 Hydraulic Oil Filter..... H-55270 Hydraulic Oil Filter..... H-5526 Hydraulic Oil Filter..... H-55280 Hydraulic Oil Filter..... HC-5508		994 (LOADERS) S/N: 9YF28-48 Air Filter Secondary..... A-5552 Air Filter Primary..... A-5521 Air Filter Set..... A-5521-S Hydraulic Oil Filter..... HC-5504 Hydraulic Oil Filter..... H-55270 Hydraulic Oil Filter..... H-5526 Hydraulic Oil Filter..... H-55280 Hydraulic Oil Filter..... HC-5508	
992 (LOADERS) S/N: 25K1-1169 Air Filter Secondary..... A-5520 Air Filter Primary..... A-5558 Air Filter Set..... A-5544-S Air Filter Primary..... A-5543 Air Filter Secondary..... A-5559 Fuel Filter..... F-5501 Hydraulic Oil Filter..... H-5508 Hydraulic Oil Filter..... H-5502 Hydraulic Oil Filter..... H-5503 Oil Filter Full Flow..... O-5502		994 (LOADERS) S/N: 9Y56-109 Air Filter Secondary..... A-5556 Air Filter Set..... A-5555-S Air Filter Primary..... A-5555 Hydraulic Oil Filter..... HC-5508 Hydraulic Oil Filter..... H-55280 Hydraulic Oil Filter..... H-5526 Hydraulic Oil Filter..... H-55270 Hydraulic Oil Filter..... HC-5504		994D (LOADERS) CAT (S/N: 7TR1057-UP) Fuel Filter..... FC-5510	
992B (LOADERS) S/N: 25K1170-UP Air Filter Secondary..... A-5534 Air Filter Secondary..... A-5502 Air Filter Primary..... A-5501 Air Filter Primary..... A-5535 Air Filter Set..... A-5573-S Fuel Filter..... F-5501 Hydraulic Oil Filter..... H-5503 Hydraulic Oil Filter..... H-5502 Hydraulic Oil Filter..... H-5508 Oil Filter Full Flow..... O-5502		994 (LOADERS) S/N: 9YF110-UP Air Filter Primary..... A-5555 Air Filter Set..... A-5555-S Air Filter Secondary..... A-5556 Hydraulic Oil Filter..... HC-5504 Hydraulic Oil Filter..... H-55270 Hydraulic Oil Filter..... H-5526 Hydraulic Oil Filter..... H-55280		994D (LOADERS) CAT (S/N: 7TR360-1056) Fuel Filter..... FC-5510	
994 (LOADERS) CAT (S/N: 54Z1201-UP) Fuel Filter..... FC-5510		994 (LOADERS) S/N: 9YF1-19 Air Filter Secondary..... A-5552 Air Filter Primary..... A-5521 Air Filter Set..... A-5521-S Hydraulic Oil Filter..... H-55280 Hydraulic Oil Filter..... H-5526 Hydraulic Oil Filter..... H-55270 Hydraulic Oil Filter..... HC-5504		994D (LOADERS) CAT (S/N: 7TR1057-UP) Fuel Filter..... FC-5510	
994 (LOADERS) CAT (S/N: 54Z486-1200) Fuel Filter..... FC-5510		994 (LOADERS) S/N: 9YF1-19 Air Filter Secondary..... A-5552 Air Filter Primary..... A-5521 Air Filter Set..... A-5521-S Hydraulic Oil Filter..... H-55280 Hydraulic Oil Filter..... H-5526 Hydraulic Oil Filter..... H-55270 Hydraulic Oil Filter..... HC-5504		994D (LOADERS) CAT (S/N: 7TR360-1056) Fuel Filter..... FC-5510	
994 (LOADERS) S/N: 54Z1-UP Air Filter Secondary..... A-5552 Air Filter Secondary..... A-5560 Air Filter Set..... A-5562-S Air Filter Primary..... A-5561 Air Filter Primary..... A-5521 Air Filter Set..... A-5521-S Fuel Filter..... FC-5510 Hydraulic Oil Filter..... H-5506 Hydraulic Oil Filter..... H-5503 Hydraulic Oil Filter..... H-55280 Oil Filter Full Flow..... C-5516		994 (LOADERS) S/N: 9YF1-19 Air Filter Secondary..... A-5552 Air Filter Primary..... A-5521 Air Filter Set..... A-5521-S Hydraulic Oil Filter..... H-55280 Hydraulic Oil Filter..... H-5526 Hydraulic Oil Filter..... H-55270 Hydraulic Oil Filter..... HC-5504		994D (LOADERS) CAT 3516B (S/N: 3TZ1-UP) Air Filter Secondary..... A-5556 Air Filter Primary..... A-5555 Air Filter Set..... A-5555-S Fuel Filter..... FC-5510 Hydraulic Oil Filter..... H-55270 Hydraulic Oil Filter..... H-5526 Hydraulic Oil Filter..... H-55280 Hydraulic Oil Filter..... H-5504 Hydraulic Oil Filter..... HC-5504	
994 (LOADERS) S/N: 9TF1-UP		994 (LOADERS) S/N: 9YF1-UP Air Filter Set..... A-5521-S Air Filter Primary..... A-5521 Air Filter Secondary..... A-5552 Air Filter Secondary..... A-5556 Air Filter Set..... A-5555-S Air Filter Primary..... A-5555		994D (LOADERS) CAT S/N: 4421-UP , 2007-UP Air Filter Primary..... A-5564 Air Filter Secondary..... A-5563 Air Filter Set..... A-5565-S Fuel Filter..... FC-5510	

MODEL/APPLICATION	SAKURA NO	MODEL/APPLICATION	SAKURA NO	MODEL/APPLICATION	SAKURA NO
CATERPILLAR		CATERPILLAR		CATERPILLAR	
994F (LOADERS) CAT S/N: 4421-UP , 2007-UP Fuel Filter Secondary..... FC-5507 Hydraulic Oil Filter..... H-55280 Hydraulic Oil Filter..... H-5526 Hydraulic Oil Filter..... HC-5504 Hydraulic Oil Filter..... HC-5512		Air Filter Secondary..... A-5529 Air Filter Primary..... A-5521 Air Filter Set..... A-5521-S Fuel Filter..... FC-5519 Hydraulic Oil Filter..... H-5504 Oil Filter Full Flow..... C-5516		AP-1000 (ASPHALT PAVER) S/N: 1HD1-UP Air Filter Set..... A-5507-S Air Filter Primary..... A-5507 Air Filter Set..... A-55071-S Air Filter Set..... A-5568-S Air Filter Primary..... A-5566 Air Filter Secondary..... A-5567 Fuel Filter Secondary..... FC-5507 Oil Filter Full Flow..... C-5510	
994F (LOADERS) CAT S/N: 8WM1-UP , 2007-UP Air Filter Set..... A-5565-S Air Filter Secondary..... A-5563 Air Filter Primary..... A-5564 Fuel Filter Secondary..... FC-5507 Fuel Filter..... FC-5510 Hydraulic Oil Filter..... HC-5512 Hydraulic Oil Filter..... HC-5504 Hydraulic Oil Filter..... H-5526 Hydraulic Oil Filter..... H-55280		AD45 (ARTICULATED TRUCKS) S/N: BKZ181-UP Air Filter Secondary..... A-5715 Fuel Filter..... FC-5509 Hydraulic Oil Filter..... H-5504 Hydraulic Oil Filter..... H-5503 Hydraulic Oil Filter..... H-55280 Hydraulic Oil Filter..... H-55270 Hydraulic Oil Filter..... H-5526 Oil Filter Full Flow..... C-5516		AP-1000B (ASPHALT PAVER) CAT (S/N: 98Z16051-30399-UP) Fuel Filter..... FC-5508 Fuel Filter..... FC-5516 Fuel Filter Secondary..... FC-55151 Fuel Filter Secondary..... FC-5515 Oil Filter Full Flow..... C-5522	
994F (LOADERS) CAT 3516BTA Cabin Air Filter..... CA-55120		AD55 (ARTICULATED TRUCKS) CAT C18 DITA ATAAC Cabin Air Filter..... CA-55100		AP-1000B (ASPHALT PAVER) CAT S/N: 4TF84000-UP Fuel Filter Secondary..... FC-5515 Fuel Filter Secondary..... FC-55151 Fuel Filter..... FC-5516 Fuel Filter..... FC-5508 Oil Filter Full Flow..... C-5522	
994G (LOADERS) CAT S/N: 7TR1-UP Air Filter Set..... A-5555-S Air Filter Primary..... A-5555 Air Filter Secondary..... A-5556 Fuel Filter Secondary..... FC-5507 Fuel Filter..... FC-5510 Hydraulic Oil Filter..... H-5526 Hydraulic Oil Filter..... H-55270 Hydraulic Oil Filter..... H-55280		AD55 (ARTICULATED TRUCKS) S/N: ANW1-UP Air Filter Secondary..... A-5715 Fuel Filter..... FC-5509 Hydraulic Oil Filter..... HC-55300 Hydraulic Oil Filter..... HC-5512 Hydraulic Oil Filter..... HC-5516 Hydraulic Oil Filter..... HC-5506 Hydraulic Oil Filter..... HC-5504 Hydraulic Oil Filter..... HC-5503 Oil Filter Full Flow..... C-5516		AP-1000B (ASPHALT PAVER) CAT S/N: 98Z30400-UP Fuel Filter..... FC-5508 Fuel Filter..... FC-5516 Fuel Filter Secondary..... FC-55151 Fuel Filter Secondary..... FC-5515 Oil Filter Full Flow..... C-5522	
994G (LOADERS) CAT S/N: 8FR1-UP Air Filter Secondary..... A-5556 Air Filter Primary..... A-5555 Air Filter Set..... A-5555-S Fuel Filter..... FC-5510 Fuel Filter Secondary..... FC-5507 Hydraulic Oil Filter..... H-55280 Hydraulic Oil Filter..... H-55270 Hydraulic Oil Filter..... H-5526		AE40 (ARTICULATED TRUCKS) S/N: 1ZZ1-UP Air Filter Secondary..... A-5715 Fuel Filter..... FC-5509 Hydraulic Oil Filter..... H-5526 Hydraulic Oil Filter..... H-55270 Hydraulic Oil Filter..... H-55280 Hydraulic Oil Filter..... H-5503 Hydraulic Oil Filter..... H-5504 Oil Filter Full Flow..... C-5516		AP-1000B (ASPHALT PAVER) S/N: 7HN1-253-UP Air Filter Secondary..... A-5567 Air Filter Primary..... A-5566 Air Filter Set..... A-5568-S Hydraulic Oil Filter..... HC-5507 Hydraulic Oil Filter..... HC-55220 Hydraulic Oil Filter..... H-5517	
994G (LOADERS) CAT 3516BTA Cabin Air Filter..... CA-55120		AE40 SERIES II (ARTICULATED TRUCKS) S/N: BLW181-UP Air Filter Secondary..... A-5715 Fuel Filter..... FC-5509 Hydraulic Oil Filter..... H-5504 Hydraulic Oil Filter..... H-5503 Hydraulic Oil Filter..... H-55280 Hydraulic Oil Filter..... H-55270 Hydraulic Oil Filter..... H-5526 Oil Filter Full Flow..... C-5516		AP-1000B (ASPHALT PAVER) S/N: 7HN254-311-UP Air Filter Primary..... A-5566 Air Filter Secondary..... A-5567 Air Filter Secondary..... A-5559 Air Filter Primary..... A-5558 Air Filter Set..... A-5568-S Hydraulic Oil Filter..... H-5517 Hydraulic Oil Filter..... HC-55220 Hydraulic Oil Filter..... HC-5507	
998A (LOADERS) Air Filter Set..... A-5521-S Air Filter Primary..... A-5521 Air Filter Secondary..... A-5520 Air Filter Secondary..... A-5529 Air Filter Set..... A-5544-S Air Filter Primary..... A-5543 Fuel Filter..... F-5501 Fuel Filter..... FC-5501 Hydraulic Oil Filter..... H-5503 Oil Filter Full Flow..... O-5503		AG55 (MOTOR GRADERS) Air Filter..... A-85400		AP-1000B (ASPHALT PAVER) S/N: 7HN312-UP Air Filter Primary..... A-5558 Air Filter Secondary..... A-5559 Air Filter Secondary..... A-5567 Air Filter Primary..... A-5566 Air Filter Set..... A-5568-S Hydraulic Oil Filter..... HC-5507 Hydraulic Oil Filter..... HC-55220	
998B (LOADERS)		AP-1000 (ASPHALT PAVER) CAT 3116TA Air Filter Set..... A-44180-S Air Filter Primary..... A-44180		AP-1000B (ASPHALT PAVER) S/N: 7HN312-UP Air Filter Primary..... A-5558 Air Filter Secondary..... A-5559 Air Filter Secondary..... A-5567 Air Filter Primary..... A-5566 Air Filter Set..... A-5568-S Hydraulic Oil Filter..... HC-5507 Hydraulic Oil Filter..... HC-55220	

Sakura Filter

ENGINE APPLICATION

MODEL/APPLICATION	SAKURA NO	MODEL/APPLICATION	SAKURA NO	MODEL/APPLICATION	SAKURA NO
CATERPILLAR		CATERPILLAR		CATERPILLAR	
AP-1000B (ASPHALT PAVER) S/N: 7HN312-UP		Air Filter Secondary.....	A-5559	Air Filter Primary.....	A-56731
Hydraulic Oil Filter.....	H-5517	Fuel Filter.....	FC-5517	Air Filter Set.....	A-56731-S
		Hydraulic Oil Filter.....	H-5517		
AP-1000B (ASPHALT PAVER) S/N: AGP1-175-UP		Hydraulic Oil Filter.....	HC-5504	AP-650B (ASPHALT PAVER) CAT 7BJ1-UP	
Air Filter Secondary.....	A-5559	Oil Filter Full Flow.....	C-5522	Air Filter Set.....	A-56731-S
Air Filter Primary.....	A-5558			Air Filter Primary.....	A-56731
Hydraulic Oil Filter.....	HC-55220	AP-1055D (ASPHALT PAVER) CAT S/N: FAC1-UP		Air Filter Secondary.....	A-56741
Hydraulic Oil Filter.....	HC-5507	Air Filter Primary.....	A-5558		
Hydraulic Oil Filter.....	H-5517	Air Filter Secondary.....	A-5559	AP-650B (ASPHALT PAVER) CAT 3054TA	
		Fuel Filter.....	FC-5517	Air Filter Secondary.....	A-4211
AP-1000B (ASPHALT PAVER) S/N: AGP176-UP		Hydraulic Oil Filter.....	HC-5504	Air Filter Set.....	A-4212-S
Air Filter Primary.....	A-5558	Hydraulic Oil Filter.....	H-5517	Air Filter Primary.....	A-4210
Air Filter Secondary.....	A-5559	Oil Filter Full Flow.....	C-5522		
Hydraulic Oil Filter.....	H-5517			AP-650B (ASPHALT PAVER)	
Hydraulic Oil Filter.....	HC-5507	AP-1055D (ASPHALT PAVER) CAT S/N: KHX1-UP		Air Filter Primary.....	A-76600
Hydraulic Oil Filter.....	HC-55220	Air Filter Primary.....	A-5558	Oil Filter Full Flow.....	C-5102
		Air Filter Secondary.....	A-5559		
AP-1000D (ASPHALT PAVER) CAT S/N: EAD1-UP		Fuel Filter.....	FC-5517	AP-650B (ASPHALT PAVER) w/3054C Eng.	
Air Filter Secondary.....	A-5559	Hydraulic Oil Filter.....	H-5517	Fuel/Water Separator.....	SFC-43040
Air Filter Primary.....	A-5558	Hydraulic Oil Filter.....	HC-5504		
Fuel Filter.....	FC-5517	Oil Filter Full Flow.....	C-5522	AP-655C (ASPHALT PAVER) CAT (S/N: CPT1-UP)	
Hydraulic Oil Filter.....	H-5517			Fuel Filter.....	FC-5517
Hydraulic Oil Filter.....	HC-5504	AP-100B (ASPHALT PAVER)		Oil Filter Full Flow.....	C-5101
Oil Filter Full Flow.....	C-5522	Air Filter Secondary.....	A-5567	Oil Filter Full Flow.....	C-5522
		Air Filter Primary.....	A-5566		
AP-1000D (ASPHALT PAVER) CAT S/N: KHX1-UP		Air Filter Set.....	A-5568-S	AP-655C (ASPHALT PAVER) S/N: AYP1-UP	
Air Filter Primary.....	A-5558	Fuel Filter.....	FC-5508	Air Filter Primary.....	A-5558
Air Filter Secondary.....	A-5559	Oil Filter Full Flow.....	C-5510	Air Filter Secondary.....	A-5559
Fuel Filter.....	FC-5517			Hydraulic Oil Filter.....	H-5517
Hydraulic Oil Filter.....	H-5517	AP-1055 (ASPHALT PAVER)		Hydraulic Oil Filter.....	HC-5504
Hydraulic Oil Filter.....	HC-5504	Air Filter Set.....	A-5568-S		
Oil Filter Full Flow.....	C-5522	Air Filter Primary.....	A-5566	AP-655C (ASPHALT PAVER) S/N: CDG1-UP	
		Air Filter Secondary.....	A-5567	Air Filter Primary.....	A-5558
AP-1050 (ASPHALT PAVER) CAT 3116T		Fuel Filter.....	FC-5508	Air Filter Secondary.....	A-5559
Air Filter Primary.....	A-44180	Fuel Filter.....	FC-5516	Hydraulic Oil Filter.....	HC-5504
Air Filter Set.....	A-44180-S	Fuel Filter Secondary.....	FC-5515	Hydraulic Oil Filter.....	H-5517
		Fuel Filter Secondary.....	FC-55151		
AP-1050B (ASPHALT PAVER) CAT 3116		Oil Filter Full Flow.....	C-5510	AP-800B (ASPHALT PAVER) S/N: 1BF1-224	
Air Filter.....	A-5530			Air Filter Set.....	AS-5656-S
Air Filter Primary.....	A-5507	AP-1200 (ASPHALT PAVER) S/N: 2JD1-UP		Air Filter Primary.....	AS-7805
Air Filter Set.....	A-5507-S	Oil Filter Full Flow.....	C-5101	Fuel Filter.....	FC-5103
Air Filter Set.....	A-55071-S			Oil Filter Full Flow.....	C-5101
Air Filter Set.....	A-5568-S	AP-200 (ASPHALT PAVER) HATZ 2M40			
Air Filter Primary.....	A-5566	Air Filter.....	A-8678	AP-800C (ASPHALT PAVER) CAT (S/N: 5HK1-UP)	
Air Filter Secondary.....	A-5567			Oil Filter Full Flow.....	C-5102
Fuel Filter.....	F-5505	AP-200B (ASPHALT PAVER) S/N: 2NK1-UP		Oil Filter Full Flow.....	C-5101
Fuel Filter.....	FC-5516	Air Filter.....	A-8678		
Fuel Filter Secondary.....	FC-55151	Fuel Filter.....	FC-6205	AP-800C (ASPHALT PAVER) CAT (S/N: 7BJ1-UP)	
Fuel Filter Secondary.....	FC-5515			Air Filter Set.....	A-5675-S
Fuel Filter.....	FC-5508	AP-300 (ASPHALT PAVER) w/3054C Eng.		Air Filter Secondary.....	A-8670
Fuel Filter Secondary.....	FC-5507	Fuel/Water Separator.....	SFC-43040	Air Filter Primary.....	A-5673
Hydraulic Oil Filter.....	H-5517			Oil Filter Full Flow.....	C-5102
Hydraulic Oil Filter.....	H-57030	AP-300D (ASPHALT PAVER) w/C4.4 Eng. , 4400		Oil Filter Full Flow.....	C-5101
Oil Filter Full Flow.....	C-5510	Fuel/Water Separator.....	SFC-43040		
				AP-800C (ASPHALT PAVER) CAT 7BJ1-UP	
AP-1055D (ASPHALT PAVER) CAT S/N: A6P1-UP		AP-650B (ASPHALT PAVER) CAT 3054C		Air Filter Primary.....	A-56731
Air Filter Primary.....	A-5558	Air Filter Secondary.....	A-56741		

Sakura Filter

ENGINE APPLICATION

MODEL/APPLICATION	SAKURA NO	MODEL/APPLICATION	SAKURA NO	MODEL/APPLICATION	SAKURA NO
CATERPILLAR		CATERPILLAR		CATERPILLAR	
AP-800C (ASPHALT PAVER) CAT 7B31-UP Air Filter Set..... A-56731-S Air Filter Secondary..... A-56741		Air Filter Primary..... A-5566 Air Filter Secondary..... A-5567 Fuel Filter Secondary..... FC-5515 Fuel Filter Secondary..... FC-55151 Fuel Filter..... FC-5516 Fuel Filter..... FC-5508 Hydraulic Oil Filter..... H-5517 Hydraulic Oil Filter..... HC-55220 Hydraulic Oil Filter..... HC-5507 Oil Filter Full Flow..... C-5522		BG-225C (ASPHALT PAVER) S/N: 5GN504-UP Air Filter Primary..... A-76600 Hydraulic Oil Filter..... HC-5507 Hydraulic Oil Filter..... HC-55220 Hydraulic Oil Filter..... H-5517	
AP-800C (ASPHALT PAVER) S/N: 1PM1-UP Air Filter Primary..... A-5581 Air Filter Secondary..... A-5582 Air Filter Set..... A-5583-S Hydraulic Oil Filter..... H-5517 Hydraulic Oil Filter..... HC-55220 Hydraulic Oil Filter..... HC-5507 Hydraulic Oil Filter..... HC-76080		BG-2255C (ASPHALT PAVER) CAT (S/N: CPT1-UP) Fuel Filter..... FC-5517 Oil Filter Full Flow..... C-5522 Oil Filter Full Flow..... C-5101		BG-225C (ASPHALT PAVER) S/N: B6G1-UP Hydraulic Oil Filter..... HC-5507 Hydraulic Oil Filter..... H-5517 Hydraulic Oil Filter..... HC-55220	
AP-800D (ASPHALT PAVER) CAT (S/N: CRS1-UP) Oil Filter Full Flow..... C-5102		BG-2255C (ASPHALT PAVER) S/N: B9G1-UP Air Filter Primary..... A-5558 Air Filter Secondary..... A-5559 Hydraulic Oil Filter..... HC-5504 Hydraulic Oil Filter..... H-5517		BG-225C (ASPHALT PAVER) CAT (S/N: 3054C Eng.) Fuel/Water Separator..... SFC-43040	
AP-800D (ASPHALT PAVER) S/N: ASP1-151-UP Air Filter Secondary..... A-8670 Air Filter Set..... A-5675-S Air Filter Primary..... A-5673 Hydraulic Oil Filter..... HC-55220 Hydraulic Oil Filter..... H-5517 Hydraulic Oil Filter..... HC-5507		BG-2255C (ASPHALT PAVER) S/N: CKR1-UP Air Filter Secondary..... A-5559 Air Filter Primary..... A-5558 Hydraulic Oil Filter..... H-5517 Hydraulic Oil Filter..... HC-5504		BG-230 (ASPHALT PAVER) CAT (S/N: 5HK1-UP) Oil Filter Full Flow..... C-5102 Oil Filter Full Flow..... C-5101	
AP-800D (ASPHALT PAVER) S/N: ASP152-UP Air Filter Secondary..... A-8670 Air Filter Primary..... A-5673 Air Filter Set..... A-5675-S Hydraulic Oil Filter..... H-5517 Hydraulic Oil Filter..... HC-55220 Hydraulic Oil Filter..... HC-5507		BG-2255C (ASPHALT PAVER) S/N: CKR1-UP Air Filter Secondary..... A-5559 Air Filter Primary..... A-5558 Hydraulic Oil Filter..... H-5517 Hydraulic Oil Filter..... HC-5504		BG-230 (ASPHALT PAVER) CAT (S/N: 7B31-UP) Air Filter Set..... A-5675-S Air Filter Primary..... A-5673 Air Filter Secondary..... A-8670 Oil Filter Full Flow..... C-5101 Oil Filter Full Flow..... C-5102	
AP-800D (ASPHALT PAVER) w/3054C Eng. Fuel/Water Separator..... SFC-43040		BG-225C (ASPHALT PAVER) CAT (S/N: 5HK59985-UP) Oil Filter Full Flow..... C-5102		BG-230 (ASPHALT PAVER) CAT (S/N: 9RM1-UP) Oil Filter Full Flow..... C-5102 Oil Filter Full Flow..... C-5101	
AP-800 (ASPHALT PAVER) PERKINS 4.236 Air Filter Primary..... AS-7805 Air Filter Set..... AS-5656-S Fuel Filter..... FC-5103 Oil Filter Full Flow..... C-5101		BG-225C (ASPHALT PAVER) CAT (S/N: 7B31-UP , 2011) Air Filter Primary..... A-56731 Air Filter Secondary..... A-56741 Air Filter Set..... A-56731-S		BG-230 (ASPHALT PAVER) CAT (S/N: 9AL1-UP) Air Filter Set..... A-56731-S Air Filter Secondary..... A-56741	
AP-900B (ASPHALT PAVER) CAT S/N: 98Z31739-UP Air Filter Secondary..... A-5567 Air Filter Primary..... A-5566 Air Filter Set..... A-5568-S Fuel Filter..... FC-5508 Fuel Filter..... FC-5516 Fuel Filter Secondary..... FC-55151 Fuel Filter Secondary..... FC-5515 Hydraulic Oil Filter..... H-5517 Hydraulic Oil Filter..... HC-5507 Hydraulic Oil Filter..... HC-55220 Oil Filter Full Flow..... C-5522		BG-225C (ASPHALT PAVER) CAT (S/N: CRS2700-UP) Oil Filter Full Flow..... C-5102		BG-230 (ASPHALT PAVER) CAT (S/N: 98Z31739-UP) Air Filter Set..... A-5583-S Air Filter Secondary..... A-5582 Air Filter Primary..... A-5581 Hydraulic Oil Filter..... H-5517 Hydraulic Oil Filter..... HC-76080 Hydraulic Oil Filter..... HC-55220 Hydraulic Oil Filter..... HC-5507	
AP-900B (ASPHALT PAVER) CAT S/N: AG31-UP Air Filter Set..... A-5568-S		BG-225C (ASPHALT PAVER) CAT 3054C Air Filter Primary..... A-4210 Air Filter Set..... A-4212-S Air Filter Secondary..... A-4211		BG-240C (ASPHALT PAVER) CAT S/N: 98Z31739-UP Air Filter Set..... A-5568-S Air Filter Primary..... A-5566 Air Filter Secondary..... A-5567 Fuel Filter..... FC-5516 Fuel Filter Secondary..... FC-5515 Fuel Filter Secondary..... FC-55151 Fuel Filter..... FC-5508 Hydraulic Oil Filter..... H-5517 Hydraulic Oil Filter..... HC-5507 Hydraulic Oil Filter..... HC-55220 Oil Filter Full Flow..... C-5522	
		BG-225C (ASPHALT PAVER) S/N: 5GN1-503-UP Air Filter Primary..... A-76600 Hydraulic Oil Filter..... H-5517 Hydraulic Oil Filter..... HC-55220 Hydraulic Oil Filter..... HC-5507			

Sakura Filter

ENGINE APPLICATION

MODEL/APPLICATION	SAKURA NO	MODEL/APPLICATION	SAKURA NO	MODEL/APPLICATION	SAKURA NO
CATERPILLAR		CATERPILLAR		CATERPILLAR	
BG-240C (ASPHALT PAVER) CAT S/N: AGL1-UP Air Filter Secondary..... A-5567 Air Filter Primary..... A-5566 Air Filter Set..... A-5568-S Fuel Filter..... FC-5508 Fuel Filter Secondary..... FC-55151 Fuel Filter Secondary..... FC-5515 Fuel Filter..... FC-5516 Hydraulic Oil Filter..... HC-55220 Hydraulic Oil Filter..... HC-5507 Hydraulic Oil Filter..... H-5517 Oil Filter Full Flow..... C-5522		BG-2455C (ASPHALT PAVER) S/N: ACM253-UP Air Filter Primary..... A-5558 Air Filter Secondary..... A-5559 Hydraulic Oil Filter..... H-5517 Hydraulic Oil Filter..... HC-55220 Hydraulic Oil Filter..... HC-5507 BG-2455C (ASPHALT PAVER) S/N: B2G1-UP Air Filter Secondary..... A-5559 Air Filter Primary..... A-5558 Hydraulic Oil Filter..... HC-5507 Hydraulic Oil Filter..... HC-55220 Hydraulic Oil Filter..... H-5517 BG-2455D (ASPHALT PAVER) CAT S/N: BNW1-UP Air Filter Primary..... A-5558 Air Filter Secondary..... A-5559 Fuel Filter..... FC-5517 Hydraulic Oil Filter..... HC-5504 Hydraulic Oil Filter..... H-5517 Oil Filter Full Flow..... C-5522 BG-2455D (ASPHALT PAVER) CAT S/N: BXW1-UP Air Filter Secondary..... A-5559 Air Filter Primary..... A-5558 Fuel Filter..... FC-5517 Hydraulic Oil Filter..... H-5517 Hydraulic Oil Filter..... HC-5504 Oil Filter Full Flow..... C-5522 BG-2455D (ASPHALT PAVER) CAT S/N: KHX1-UP Air Filter Primary..... A-5558 Air Filter Secondary..... A-5559 Fuel Filter..... FC-5517 Hydraulic Oil Filter..... HC-5504 Hydraulic Oil Filter..... H-5517 Oil Filter Full Flow..... C-5522 BG-245C (ASPHALT PAVER) CAT S/N: 98Z1135-16275-UP Fuel Filter..... FC-5516 Fuel Filter Secondary..... FC-5515 Fuel Filter Secondary..... FC-55151 Fuel Filter..... FC-5508 Oil Filter Full Flow..... C-5522 BG-2455C (ASPHALT PAVER) S/N: 6TN1-UP Air Filter Secondary..... A-5567 Air Filter Primary..... A-5566 Air Filter Set..... A-5568-S Hydraulic Oil Filter..... H-5517 Hydraulic Oil Filter..... HC-55220 Hydraulic Oil Filter..... HC-5507 BG-2455C (ASPHALT PAVER) S/N: ACM1-252-UP Air Filter Set..... A-5568-S Air Filter Primary..... A-5566 Air Filter Secondary..... A-5567 Hydraulic Oil Filter..... HC-5507 Hydraulic Oil Filter..... HC-55220 Hydraulic Oil Filter..... H-5517		Oil Filter Full Flow..... C-5522 BG-245C (ASPHALT PAVER) S/N: 4XN1-109-UP Air Filter Set..... A-5568-S Air Filter Primary..... A-5566 Air Filter Secondary..... A-5567 Hydraulic Oil Filter..... HC-5507 Hydraulic Oil Filter..... HC-55220 Hydraulic Oil Filter..... H-5517 BG-245C (ASPHALT PAVER) S/N: 4XN110-UP Air Filter Set..... A-5568-S Air Filter Secondary..... A-5559 Air Filter Primary..... A-5558 Air Filter Secondary..... A-5567 Air Filter Primary..... A-5566 Hydraulic Oil Filter..... H-5517 Hydraulic Oil Filter..... HC-55220 Hydraulic Oil Filter..... HC-5507 BG-260C (ASPHALT PAVER) CAT S/N: 98Z16051-30399-UP Fuel Filter..... FC-5508 Fuel Filter Secondary..... FC-55151 Fuel Filter..... FC-5516 Fuel Filter Secondary..... FC-5515 Oil Filter Full Flow..... C-5522 BG-260C (ASPHALT PAVER) CAT S/N: 4TF84000-UP Fuel Filter Secondary..... FC-5515 Fuel Filter..... FC-5516 Fuel Filter Secondary..... FC-55151 Fuel Filter..... FC-5508 Oil Filter Full Flow..... C-5522 BG-260C (ASPHALT PAVER) CAT S/N: 98Z30400-UP Fuel Filter Secondary..... FC-5515 Fuel Filter..... FC-5508 Fuel Filter Secondary..... FC-55151 Fuel Filter..... FC-5508 Oil Filter Full Flow..... C-5522 BG-260C (ASPHALT PAVER) S/N: 8GN1-547-UP Air Filter Secondary..... A-5567 Air Filter Primary..... A-5566 Air Filter Set..... A-5568-S Hydraulic Oil Filter..... HC-55220 Hydraulic Oil Filter..... HC-5507 Hydraulic Oil Filter..... H-5517 BG-260C (ASPHALT PAVER) S/N: 8GN548-576-UP Air Filter Set..... A-5568-S Air Filter Primary..... A-5566 Air Filter Secondary..... A-5567 Air Filter Secondary..... A-5559 Air Filter Primary..... A-5558 Hydraulic Oil Filter..... H-5517 Hydraulic Oil Filter..... HC-5507 Hydraulic Oil Filter..... HC-55220	

Sakura Filter

ENGINE APPLICATION

MODEL/APPLICATION	SAKURA NO	MODEL/APPLICATION	SAKURA NO	MODEL/APPLICATION	SAKURA NO
CATERPILLAR		CATERPILLAR		CATERPILLAR	
BG-260C <i>(ASPHALT PAVER)</i> S/N: 8GN577-UP Air Filter Primary..... A-5558 Air Filter Secondary..... A-5559 Air Filter Secondary..... A-5567 Air Filter Primary..... A-5566 Air Filter Set..... A-5568-S Hydraulic Oil Filter..... HC-55220 Hydraulic Oil Filter..... HC-5507 Hydraulic Oil Filter..... H-5517		BG-650 <i>(ASPHALT PAVER)</i> CAT (S/N: 5HK1-UP) Oil Filter Full Flow..... C-5102 Oil Filter Full Flow..... C-5101 BG-650 <i>(ASPHALT PAVER)</i> CAT (S/N: 9RM1-UP) Oil Filter Full Flow..... C-5101 Oil Filter Full Flow..... C-5102 C10 <i>(ENGINES)</i> S/N: 9RM1-UP Oil Filter Full Flow..... C-5516 C3.3 <i>(GENERATORS)</i> Fuel/Water Separator..... SFC-43040 C4.4 <i>(GENERATORS)</i> Fuel/Water Separator..... SFC-43040 C54B <i>(COMPACTORS)</i> w/C4.4 Eng. , 4400 Cabin Air Filter..... CA-55150 C70 <i>(ENGINES)</i> 7.2L , 7200 Air Filter Primary..... A-5535M Air Filter Set..... A-5573M-S CB-14 <i>(COMPACTORS)</i> S/N: CAA1-UP , 2007-UP Oil Filter Full Flow..... C-1123 CB-214C <i>(COMPACTORS)</i> S/N: 9XK00826-UP Air Filter..... A-8678 Hydraulic Oil Filter..... HC-5504 CB-214C <i>(COMPACTORS)</i> S/N: 9XK1-UP Air Filter..... A-8678 Hydraulic Oil Filter..... HC-5504 CB-214D <i>(COMPACTORS)</i> CAT S/N: 1T21-UP , 2007-UP Air Filter Secondary..... A-5569 Hydraulic Oil Filter..... HC-5507 Hydraulic Oil Filter..... HC-55220 Oil Filter Full Flow..... C-1123 Oil Filter Full Flow..... C-1906 CB-214D <i>(COMPACTORS)</i> CAT S/N: 4ZW1-UP , 2007-UP Air Filter Secondary..... A-5569 Hydraulic Oil Filter..... HC-55220 Hydraulic Oil Filter..... HC-5507 Oil Filter Full Flow..... C-1906 Oil Filter Full Flow..... C-1123 CB-224D <i>(COMPACTORS)</i> CAT S/N: 8R21-UP) Air Filter Secondary..... A-5569 Hydraulic Oil Filter..... HC-5507 Oil Filter Full Flow..... C-1123		CB-225D <i>(COMPACTORS)</i> CAT S/N: 4ZW1-UP Air Filter Secondary..... A-5569 Hydraulic Oil Filter..... HC-5507 Oil Filter Full Flow..... C-1906 Oil Filter Full Flow..... C-1123 CB-225D <i>(COMPACTORS)</i> CAT S/N: 9FZ1-UP Air Filter Secondary..... A-5569 Hydraulic Oil Filter..... HC-5507 Oil Filter Full Flow..... C-1906 Oil Filter Full Flow..... C-1123 CB-214B <i>(COMPACTORS)</i> S/N: 6LF1-UP Air Filter..... A-8678 CB-214E <i>(COMPACTORS)</i> CAT 3013C (S/N: 2141-UP) Air Filter Secondary..... A-5569 Hydraulic Oil Filter..... HC-5507 Oil Filter Full Flow..... C-1123 CB-224E <i>(COMPACTORS)</i> CAT 3013C (S/N: 2241-UP) Air Filter Secondary..... A-5569 Hydraulic Oil Filter..... HC-5507 Oil Filter Full Flow..... C-1123 CB-225E <i>(COMPACTORS)</i> CAT 3013C (S/N: 2251-UP) , 2004-UP Air Filter Secondary..... A-5569 Hydraulic Oil Filter..... HC-5507 Oil Filter Full Flow..... C-1123 CB-334D <i>(COMPACTORS)</i> CAT (S/N: 4HW1-UP) Fuel Filter..... F-1901 Oil Filter Full Flow..... C-1906 CB-334D <i>(COMPACTORS)</i> CAT S/N: 4ZW1-UP Oil Filter Full Flow..... C-1123 Oil Filter Full Flow..... C-1906 CB-334D <i>(COMPACTORS)</i> CAT S/N: 4ZW6018-6157-UP Fuel Filter..... F-1901 Oil Filter Full Flow..... C-1906 Oil Filter Full Flow..... C-1123 CB-334D <i>(COMPACTORS)</i> CAT S/N: 4ZW6158-6161-UP Oil Filter Full Flow..... C-1123 Oil Filter Full Flow..... C-1906 CB-334D <i>(COMPACTORS)</i> CAT S/N: 4ZW6162-UP Fuel Filter..... F-1901 Oil Filter Full Flow..... C-1906 Oil Filter Full Flow..... C-1123 CB-334D <i>(COMPACTORS)</i> S/N: 3J21-UP Air Filter Secondary..... A-5569 Hydraulic Oil Filter..... HC-5507	
BG-260C <i>(ASPHALT PAVER)</i> S/N: BYG1-UP Air Filter Secondary..... A-5559 Air Filter Primary..... A-5558 Hydraulic Oil Filter..... HC-5507 Hydraulic Oil Filter..... HC-55220 Hydraulic Oil Filter..... H-5517		BG-260C <i>(ASPHALT PAVER)</i> S/N: BYG205-UP Air Filter Primary..... A-5558 Air Filter Secondary..... A-5559 Hydraulic Oil Filter..... H-5517 Hydraulic Oil Filter..... HC-55220 Hydraulic Oil Filter..... HC-5507		BG-260D <i>(ASPHALT PAVER)</i> CAT S/N: BPW1-UP Air Filter Secondary..... A-5559 Air Filter Primary..... A-5558 Fuel Filter..... FC-5517 Hydraulic Oil Filter..... H-5517 Hydraulic Oil Filter..... HC-5504 Oil Filter Full Flow..... C-5522	
BG-260D <i>(ASPHALT PAVER)</i> CAT S/N: KHX1-UP Air Filter Primary..... A-5558 Air Filter Secondary..... A-5559 Fuel Filter..... FC-5517 Hydraulic Oil Filter..... HC-5504 Hydraulic Oil Filter..... H-5517 Oil Filter Full Flow..... C-5522		BG-230D <i>(ASPHALT PAVER)</i> CAT S/N: B4G1-UP Air Filter Secondary..... A-8670 Air Filter Primary..... A-5673 Air Filter Set..... A-5675-S Hydraulic Oil Filter..... H-5517 Hydraulic Oil Filter..... HC-5507 Hydraulic Oil Filter..... HC-55220 Oil Filter Full Flow..... C-5102		BG-230D <i>(ASPHALT PAVER)</i> CAT S/N: CRS1-UP Air Filter Secondary..... A-8670 Air Filter Set..... A-5675-S Air Filter Primary..... A-5673 Hydraulic Oil Filter..... H-5517 Hydraulic Oil Filter..... HC-55220 Hydraulic Oil Filter..... HC-5507 Oil Filter Full Flow..... C-5102	

MODEL/APPLICATION	SAKURA NO	MODEL/APPLICATION	SAKURA NO	MODEL/APPLICATION	SAKURA NO
CATERPILLAR		CATERPILLAR		CATERPILLAR	
CB-334D (COMPACTORS) S/N: 33Z1-UP Hydraulic Oil Filter.....	HC-55220	CB-334E (COMPACTORS) CAT S/N: C3A1-UP Air Filter Secondary.....	A-5569	Hydraulic Oil Filter.....	HC-55220
CB-334D (COMPACTORS) S/N: 4CZ1-UP Air Filter Secondary.....	A-5569	Hydraulic Oil Filter.....	HC-5507	Hydraulic Oil Filter.....	HC-5507
Hydraulic Oil Filter.....	HC-55220	Hydraulic Oil Filter.....	HC-55220	Oil Filter Full Flow.....	C-1123
Hydraulic Oil Filter.....	HC-5507	Oil Filter Full Flow.....	C-1123	CB-335E (COMPACTORS) CAT S/N: C5J1-UP , 2004-UP Air Filter Secondary.....	A-5569
CB-334D (COMPACTORS) S/N: DCZ1-UP Air Filter Secondary.....	A-5569	CB-334E (COMPACTORS) CAT S/N: C3D1-UP Air Filter Secondary.....	A-5569	Hydraulic Oil Filter.....	HC-5507
Hydraulic Oil Filter.....	HC-5507	Hydraulic Oil Filter.....	HC-55220	Hydraulic Oil Filter.....	HC-55220
Hydraulic Oil Filter.....	HC-55220	Hydraulic Oil Filter.....	HC-5507	Oil Filter Full Flow.....	C-1123
Oil Filter Full Flow.....	C-1906	Oil Filter Full Flow.....	C-1123	CB-335E (COMPACTORS) CAT S/N: CSD1-UP , 2004-UP Air Filter Secondary.....	A-5569
CB-335D (COMPACTORS) CAT S/N: 4HW1-UP Fuel Filter.....	F-1901	CB-334E (COMPACTORS) CAT S/N: C3E1-UP Air Filter Secondary.....	A-5569	Hydraulic Oil Filter.....	HC-5507
Oil Filter Full Flow.....	C-1906	Hydraulic Oil Filter.....	HC-5507	Hydraulic Oil Filter.....	HC-55220
CB-335D (COMPACTORS) CAT S/N: 4ZW1-6017-UP Oil Filter Full Flow.....	C-1123	Hydraulic Oil Filter.....	HC-55220	Oil Filter Full Flow.....	C-1123
Oil Filter Full Flow.....	C-1906	Oil Filter Full Flow.....	C-1123	CB-335E (COMPACTORS) CAT S/N: CSD5943-UP , 2004-UP Air Filter Secondary.....	A-5569
CB-335D (COMPACTORS) CAT S/N: 4ZN6018-6157-UP Fuel Filter.....	F-1901	CB-334E (COMPACTORS) CAT S/N: C4F1-UP Air Filter Secondary.....	A-5569	Hydraulic Oil Filter.....	HC-5507
Oil Filter Full Flow.....	C-1906	Hydraulic Oil Filter.....	HC-55220	Hydraulic Oil Filter.....	HC-55220
Oil Filter Full Flow.....	C-1123	Oil Filter Full Flow.....	C-1123	Oil Filter Full Flow.....	C-1123
CB-335D (COMPACTORS) CAT S/N: 4ZW6158-6161-UP Oil Filter Full Flow.....	C-1906	CB-334E (COMPACTORS) CAT S/N: C4J1-UP Air Filter Secondary.....	A-5569	CB-335E (COMPACTORS) CAT S/N: CSS1-UP , 2004-UP Air Filter Secondary.....	A-5569
Oil Filter Full Flow.....	C-1123	Hydraulic Oil Filter.....	HC-5507	Hydraulic Oil Filter.....	HC-55220
CB-335D (COMPACTORS) CAT S/N: 4ZW6162-UP Fuel Filter.....	F-1901	Hydraulic Oil Filter.....	HC-55220	Hydraulic Oil Filter.....	HC-5507
Oil Filter Full Flow.....	C-1906	Oil Filter Full Flow.....	C-1123	Oil Filter Full Flow.....	C-1123
Oil Filter Full Flow.....	C-1123	CB-334E (COMPACTORS) CAT S/N: C4X1-UP Air Filter Secondary.....	A-5569	CB-434 (COMPACTORS) CAT S/N: 3TF1-UP Fuel Filter Secondary.....	FC-5507
CB-335D (COMPACTORS) S/N: 5PZ1-UP Air Filter Secondary.....	A-5569	Hydraulic Oil Filter.....	HC-5507	Hydraulic Oil Filter.....	H-7916
Hydraulic Oil Filter.....	HC-55220	Hydraulic Oil Filter.....	HC-55220	Oil Filter Full Flow.....	C-5522
Hydraulic Oil Filter.....	HC-5507	Oil Filter Full Flow.....	C-1123	Oil Filter Full Flow.....	C-5505
CB-335D (COMPACTORS) S/N: BBW1-UP Air Filter Secondary.....	A-5569	CB-334E (COMPACTORS) CAT S/N: CSD1-UP Air Filter Secondary.....	A-5569	CB-434 (COMPACTORS) CAT S/N: 5EF1-UP Air Filter Set.....	A-5507-S
Hydraulic Oil Filter.....	HC-5507	Hydraulic Oil Filter.....	HC-5507	Air Filter Primary.....	A-5507
Hydraulic Oil Filter.....	HC-55220	Hydraulic Oil Filter.....	HC-55220	Air Filter Secondary.....	A-5567
CB-335D (COMPACTORS) S/N: D4E1-UP Air Filter Secondary.....	A-5569	Oil Filter Full Flow.....	C-1123	Air Filter Set.....	A-55071-S
Hydraulic Oil Filter.....	HC-55220	CB-334E (COMPACTORS) CAT S/N: CSS1-UP Air Filter Secondary.....	A-5569	Air Filter.....	A-5530
Hydraulic Oil Filter.....	HC-5507	Hydraulic Oil Filter.....	HC-5507	Air Filter Set.....	A-5568-S
CB-314 (COMPACTORS) S/N: 6HD134-UP Hydraulic Oil Filter.....	HC-69031	Hydraulic Oil Filter.....	HC-55220	Air Filter Primary.....	A-5566
CB-314 (COMPACTORS) S/N: 6HD1-UP Hydraulic Oil Filter.....	HC-69031	Oil Filter Full Flow.....	C-1123	Fuel Filter Secondary.....	FC-5507
CB-335E (COMPACTORS) CAT S/N: C3C1-UP , 2004-UP Air Filter Secondary.....	A-5569	CB-334E (COMPACTORS) CAT S/N: C5S1-UP Air Filter Secondary.....	A-5569	Oil Filter Full Flow.....	C-5505
Hydraulic Oil Filter.....	HC-5507	Hydraulic Oil Filter.....	HC-55220	Oil Filter Full Flow.....	C-5522
Hydraulic Oil Filter.....	HC-55220	Hydraulic Oil Filter.....	HC-5507	CB-434 (COMPACTORS) CAT S/N: 97Z1-UP Air Filter Primary.....	A-5566
Oil Filter Full Flow.....	C-1123	Oil Filter Full Flow.....	C-1123	Air Filter Set.....	A-5568-S
CB-335E (COMPACTORS) CAT S/N: C3F1-UP , 2004-UP Air Filter Secondary.....	A-5569	CB-335E (COMPACTORS) CAT S/N: C3F1-UP , 2004-UP Air Filter Secondary.....	A-5569	Air Filter.....	A-5530
Hydraulic Oil Filter.....	HC-5507	Hydraulic Oil Filter.....	HC-5507	Air Filter Set.....	A-55071-S
Hydraulic Oil Filter.....	HC-55220	Hydraulic Oil Filter.....	HC-55220	Air Filter Secondary.....	A-5567
Oil Filter Full Flow.....	C-1123	Oil Filter Full Flow.....	C-1123	Air Filter Primary.....	A-5507
CB-335E (COMPACTORS) CAT S/N: C3F1-UP , 2004-UP Air Filter Secondary.....	A-5569	CB-335E (COMPACTORS) CAT S/N: C3F1-UP , 2004-UP Air Filter Secondary.....	A-5569	Air Filter Set.....	A-5507-S
Hydraulic Oil Filter.....	HC-5507	Hydraulic Oil Filter.....	HC-55220	Fuel Filter Secondary.....	FC-5507
Hydraulic Oil Filter.....	HC-55220	Oil Filter Full Flow.....	C-1123	Hydraulic Oil Filter.....	H-7916
Oil Filter Full Flow.....	C-1123	CB-335E (COMPACTORS) CAT S/N: C3F1-UP , 2004-UP Air Filter Secondary.....	A-5569	Oil Filter Full Flow.....	C-5522
CB-335E (COMPACTORS) CAT S/N: C3F1-UP , 2004-UP Air Filter Secondary.....	A-5569	Hydraulic Oil Filter.....	HC-5507	Oil Filter Full Flow.....	C-5505

Sakura Filter

ENGINE APPLICATION

MODEL/APPLICATION	SAKURA NO	MODEL/APPLICATION	SAKURA NO	MODEL/APPLICATION	SAKURA NO
CATERPILLAR		CATERPILLAR		CATERPILLAR	
CB-434B (COMPACTORS) CAT S/N: 5HK1-20499-UP		Hydraulic Oil Filter.....	HC-5504	Air Filter Set.....	A-5675-S
Air Filter Set.....	A-5537-S	Oil Filter Full Flow.....	C-5101	Air Filter Primary.....	A-5673
Air Filter Secondary.....	A-5536			Air Filter Secondary.....	A-8670
Air Filter Primary.....	A-5537	CB-434C (COMPACTORS) CAT S/N: 7BJ1-UP , 2005-UP		Hydraulic Oil Filter.....	HC-5504
Hydraulic Oil Filter.....	HC-5504	Air Filter Secondary.....	A-5536	Oil Filter Full Flow.....	C-5102
Oil Filter Full Flow.....	C-5102	Air Filter Primary.....	A-5537	Oil Filter Full Flow.....	C-5101
Oil Filter Full Flow.....	C-5101	Air Filter Set.....	A-5537-S		
		Air Filter Primary.....	A-5675-S	CB-534D (COMPACTORS) CAT 3054C	
CB-434B (COMPACTORS) CAT S/N: 6AL1-87-UP		Air Filter Primary.....	A-5673	Air Filter Primary.....	A-56731
Air Filter Primary.....	A-5537	Air Filter Secondary.....	A-8670	Air Filter Secondary.....	A-56741
Air Filter Secondary.....	A-5536	Air Filter Secondary.....	A-8670	Air Filter Set.....	A-56731-S
Air Filter Set.....	A-5537-S	Hydraulic Oil Filter.....	HC-5504		
Hydraulic Oil Filter.....	HC-5504	Oil Filter Full Flow.....	C-5101	CB-534D (COMPACTORS) w/3054C Eng.	
Oil Filter Full Flow.....	C-5101	Oil Filter Full Flow.....	C-5102	Fuel/Water Separator.....	SFC-43040
Oil Filter Full Flow.....	C-5102				
		CB-434C (COMPACTORS) CAT 7BJ1-UP , 2005		CB-535B (COMPACTORS) CAT 7BJ1-UP , 2011	
Air Filter Primary.....	A-5537	Air Filter Primary.....	A-56731	Air Filter Primary.....	A-56731
Air Filter Secondary.....	A-5536	Air Filter Secondary.....	A-56741	Air Filter Secondary.....	A-56741
Air Filter Set.....	A-5537-S	Air Filter Set.....	A-56731-S	Air Filter Set.....	A-56731-S
Hydraulic Oil Filter.....	HC-5504				
Oil Filter Full Flow.....	C-5101	CB-434D (COMPACTORS) w/3054C Eng.		CB-535B (COMPACTORS) CAT (S/N: 5HK20500-UP)	
Oil Filter Full Flow.....	C-5102	Fuel/Water Separator.....	SFC-43040	Oil Filter Full Flow.....	C-5102
				Oil Filter Full Flow.....	C-5101
CB-434B (COMPACTORS) S/N: 6AL1-UP		CB-434D XW (COMPACTORS) w/3054C Eng.		CB-535B (COMPACTORS) CAT (S/N: 7BJ1-UP)	
Air Filter Set.....	A-5537-S	Fuel/Water Separator.....	SFC-43040	Air Filter Secondary.....	A-8670
Air Filter Secondary.....	A-5536			Air Filter Primary.....	A-5673
Air Filter Primary.....	A-5537	CB44B (COMPACTORS) W/C3.4 ENG. , 3400		Air Filter Set.....	A-5675-S
Hydraulic Oil Filter.....	HC-5504	Cabin Air Filter.....	CA-55150	Oil Filter Full Flow.....	C-5101
Oil Filter Full Flow.....	C-5102			Oil Filter Full Flow.....	C-5102
Oil Filter Full Flow.....	C-5101	CB46B (COMPACTORS) W/C3.4 ENG. , 3400		CB-535B (COMPACTORS) CAT (S/N: 9RM1-UP)	
		Cabin Air Filter.....	CA-55150	Oil Filter Full Flow.....	C-5102
CB-434B (COMPACTORS) S/N: 6AL1-UP		CB-534B (COMPACTORS) PERKINS , 2008-UP		Oil Filter Full Flow.....	C-5101
Air Filter Primary.....	A-5537	Air Filter Primary.....	A-76600		
Air Filter Secondary.....	A-5536	Hydraulic Oil Filter.....	HC-5504	CB-535B (COMPACTORS) CAT 3054T	
Air Filter Set.....	A-5537-S	Oil Filter Full Flow.....	C-5102	Air Filter Secondary.....	A-4211
Oil Filter Full Flow.....	C-5102			Air Filter Set.....	A-4212-S
Oil Filter Full Flow.....	C-5101	CB-534B (COMPACTORS) CAT 3054T		Air Filter Primary.....	A-4210
		Air Filter Secondary.....	A-4211		
CB-434C (COMPACTORS) CAT S/N: 4DN1-UP , 2005-UP		Air Filter Set.....	A-4212-S	CB-535B (COMPACTORS) CAT 7BJ1-UP	
Air Filter Primary.....	A-5537	Air Filter Primary.....	A-4210	Air Filter Secondary.....	A-56741
Air Filter Secondary.....	A-5536	Hydraulic Oil Filter.....	HC-5504	Air Filter Primary.....	A-56731
Air Filter Set.....	A-5537-S	Oil Filter Full Flow.....	C-5102	Air Filter Set.....	A-56731-S
Air Filter Set.....	A-5675-S				
Air Filter Primary.....	A-5673	CB-534B (COMPACTORS) S/N: 4JL1-UP		CB-535B (COMPACTORS) S/N: 3AR1-UP	
Air Filter Secondary.....	A-8670	Hydraulic Oil Filter.....	HC-5504	Air Filter Primary.....	A-76600
Hydraulic Oil Filter.....	HC-5504	Oil Filter Full Flow.....	C-5102	Hydraulic Oil Filter.....	HC-5504
Oil Filter Full Flow.....	C-5102				
Oil Filter Full Flow.....	C-5101	CB-534C (COMPACTORS) CAT 7BJ1-UP , 2011		CB-544 (COMPACTORS) CAT (S/N: 5HK22000-UP)	
Oil Filter Full Flow.....	C-5101	Air Filter Primary.....	A-56731	Oil Filter Full Flow.....	C-5102
		Air Filter Set.....	A-56731-S	Oil Filter Full Flow.....	C-5101
CB-434C (COMPACTORS) CAT S/N: 4MN1-UP , 2005-UP		Air Filter Secondary.....	A-56741		
Air Filter Secondary.....	A-8670	CB-534C (COMPACTORS) CAT 3054T		CB-544 (COMPACTORS) CAT (S/N: 9RM1-UP)	
Air Filter Primary.....	A-5673	Air Filter Primary.....	A-4210	Oil Filter Full Flow.....	C-5102
Air Filter Set.....	A-5675-S	Air Filter Set.....	A-4212-S	Oil Filter Full Flow.....	C-5101
Air Filter Set.....	A-5537-S	Air Filter Secondary.....	A-4211		
Air Filter Secondary.....	A-5536	CB-534C (COMPACTORS) CAT 3054T		CB-534D (COMPACTORS) CAT (S/N: 5HK22000-UP)	
Air Filter Primary.....	A-5537	Air Filter Primary.....	A-4210	Oil Filter Full Flow.....	C-5102
Hydraulic Oil Filter.....	HC-5504	Air Filter Set.....	A-4212-S	Oil Filter Full Flow.....	C-5101
Oil Filter Full Flow.....	C-5101	Air Filter Secondary.....	A-4211		
Oil Filter Full Flow.....	C-5102	CB-534D (COMPACTORS) CAT 3054C (S/N: FGH1-UP) , 2004-UP			
		Air Filter Primary.....	A-4210		
CB-434C (COMPACTORS) CAT S/N: 5H5330-UP , 2005-UP		Air Filter Set.....	A-4212-S		
Air Filter Primary.....	A-5537	Air Filter Secondary.....	A-4211		
Air Filter Secondary.....	A-5536				
Air Filter Set.....	A-5537-S				

Sakura Filter

ENGINE APPLICATION

MODEL/APPLICATION	SAKURA NO	MODEL/APPLICATION	SAKURA NO	MODEL/APPLICATION	SAKURA NO
CATERPILLAR		CATERPILLAR		CATERPILLAR	
CB-544 (COMPACTORS) S/N: 8FM1-148-UP		CB-514 (COMPACTORS) S/N: 6YD1-UP		CB54B (COMPACTORS) w/C4.4 Eng. , 4400	
Air Filter Set.....	A-5541M-S	Fuel Filter.....	F-6505	Cabin Air Filter.....	CA-55150
Air Filter Secondary.....	A-5540	CB-524 (COMPACTORS) S/N: 6TD1-UP		CB-634C (COMPACTORS) CAT (S/N: 98Z1230-3713-UP)	
Air Filter Primary.....	A-5541	Fuel Filter.....	FC-5704	Fuel Filter Secondary.....	FC-5507
Air Filter Primary.....	A-5541M	CB-524 (COMPACTORS) S/N: 6WD1-UP		Oil Filter Full Flow.....	C-5522
Air Filter Primary.....	A-76231	Fuel Filter.....	FC-5704	Oil Filter Full Flow.....	C-5510
Hydraulic Oil Filter.....	HC-5504	CB-525 (COMPACTORS) S/N: 6XD1-16-UP		CB-634C (COMPACTORS) CAT (S/N: 98Z21647-UP)	
CB-544 (COMPACTORS) S/N: 8FM149-UP		Fuel Filter.....	FC-5704	Fuel Filter.....	FC-5516
Air Filter Primary.....	A-76231	CB-525 (COMPACTORS) S/N: 6XD1-16-UP		Fuel Filter Secondary.....	FC-5515
Air Filter Primary.....	A-5541M	Fuel Filter.....	FC-5704	Fuel Filter Secondary.....	FC-55151
Air Filter Primary.....	A-5541	CB-525 (COMPACTORS) S/N: 6XD17-UP		Fuel Filter.....	FC-5508
Air Filter Secondary.....	A-5540	Fuel Filter.....	FC-5704	Oil Filter Full Flow.....	C-5510
Air Filter Set.....	A-5541M-S	CB-534 (COMPACTORS) S/N: 2EG1-UP		Oil Filter Full Flow.....	C-5522
Hydraulic Oil Filter.....	HC-5504	Fuel Filter.....	F-5505	CB-634C (COMPACTORS) CAT (S/N: 98Z3714-21646-UP)	
CB-545 (COMPACTORS) CAT (S/N: 5HK22000-UP)		Oil Filter Full Flow.....	C-5510	Fuel Filter Secondary.....	FC-55151
Oil Filter Full Flow.....	C-5102	CB-534 (COMPACTORS) S/N: 2YF1-UP		Fuel Filter Secondary.....	FC-5515
Oil Filter Full Flow.....	C-5101	Fuel Filter.....	F-5505	Fuel Filter.....	FC-5516
CB-545 (COMPACTORS) CAT (S/N: 9RM1-UP)		Oil Filter Full Flow.....	C-5510	Oil Filter Full Flow.....	C-5510
Oil Filter Full Flow.....	C-5101	CB-534D EAA1 (COMPACTORS) CAT 3054C , 2004		Oil Filter Full Flow.....	C-5522
Oil Filter Full Flow.....	C-5102	Air Filter Primary.....	A-56731	CB-634C (COMPACTORS) S/N: 3BR1-UP	
CB-545 (COMPACTORS) S/N: 2FS1-UP		Air Filter Secondary.....	A-56741	Air Filter Set.....	A-5568-S
Air Filter Primary.....	A-5541M	Air Filter Set.....	A-56731-S	Air Filter Secondary.....	A-5567
Air Filter Primary.....	A-5541	CB-534D FGH1 (COMPACTORS) CAT 3054C , 2004		Air Filter Primary.....	A-5566
Air Filter Secondary.....	A-5540	Air Filter Set.....	A-56731-S	Hydraulic Oil Filter.....	HC-5504
Air Filter Secondary.....	A-5540	Air Filter Primary.....	A-56731	CB-634C (COMPACTORS) S/N: 5CL1-UP	
Air Filter Set.....	A-5541M-S	Air Filter Secondary.....	A-56741	Air Filter Primary.....	A-5566
Air Filter Set.....	A-5541M-S	Air Filter Primary.....	A-56731	Air Filter Secondary.....	A-5567
Air Filter Primary.....	A-76231	CB-534D XW (COMPACTORS) CAT 3054C		Air Filter Set.....	A-5568-S
Hydraulic Oil Filter.....	HC-5504	Air Filter Primary.....	A-56731	Hydraulic Oil Filter.....	HC-5504
CB-564D (COMPACTORS) CAT (S/N: CRS1-UP)		Air Filter Secondary.....	A-56741	CB-634C (COMPACTORS) S/N: 7CD1-UP	
Oil Filter Full Flow.....	C-5102	Air Filter Set.....	A-56731-S	Air Filter Primary.....	A-5566
CB-564D (COMPACTORS) S/N: C6D109-UP		CB-534D XW (COMPACTORS) w/3054C Eng.		Air Filter Secondary.....	A-5567
Air Filter Primary.....	A-5673	Fuel/Water Separator.....	SFC-43040	Air Filter Set.....	A-5568-S
Air Filter Secondary.....	A-8670	CB-54 (COMPACTORS) CAT C4.4 , 4400, 2012		Hydraulic Oil Filter.....	HC-5504
Air Filter Secondary.....	A-8670	Air Filter Set.....	A-56731-S	CB-634C (COMPACTORS) S/N: 5CL1-UP	
Air Filter Set.....	A-5675-S	Air Filter Primary.....	A-56731	Fuel Filter Secondary.....	FC-5507
Hydraulic Oil Filter.....	HC-5504	Air Filter Secondary.....	A-56741	Oil Filter Full Flow.....	C-5519
CB-564D (COMPACTORS) S/N: C6D1-108-UP		Air Filter Primary.....	A-56731	CB-624 (COMPACTORS) S/N: 7DD1-UP	
Air Filter Secondary.....	A-8670	CB-54 XW (COMPACTORS) CAT C4.4 , 4400, 2012		Air Filter Primary.....	A-5509
Air Filter Primary.....	A-5673	Air Filter Primary.....	A-56731	Air Filter Secondary.....	A-5510
Air Filter Set.....	A-5675-S	Air Filter Secondary.....	A-56741	Air Filter Set.....	A-5522-S
Hydraulic Oil Filter.....	HC-5504	Air Filter Primary.....	A-56731	Air Filter Primary.....	A-5549
CB-564D (COMPACTORS) S/N: D4M1-UP		CB-54 XW (COMPACTORS) w/C4.4 Eng.		Air Filter Primary.....	A-5549M
Air Filter Set.....	A-5675-S	Fuel/Water Separator.....	SFC-55170	Air Filter Secondary.....	A-5550
Air Filter Primary.....	A-5673	CB-54 (COMPACTORS) S/N: 6YD1-UP		Air Filter Set.....	A-5549M-S
Air Filter Secondary.....	A-8670	Fuel Filter.....	F-6505	Fuel Filter Secondary.....	FC-5507
Hydraulic Oil Filter.....	HC-5504	Oil Filter Full Flow.....	C-5510	Oil Filter Full Flow.....	C-5519
CB-564D (COMPACTORS) S/N: D4M1-UP		CB-54 XW (COMPACTORS) w/C4.4 Eng.		CB-634 (COMPACTORS) S/N: 5CL1-UP	
Air Filter Set.....	A-5675-S	Fuel/Water Separator.....	SFC-43040	Fuel Filter Secondary.....	FC-5507
Air Filter Primary.....	A-5673	CB-54 (COMPACTORS) S/N: 6YD1-UP		Fuel Filter Secondary.....	FC-55151
Air Filter Secondary.....	A-8670	Fuel Filter.....	F-6505	Fuel Filter Secondary.....	FC-5515
Hydraulic Oil Filter.....	HC-5504	Oil Filter Full Flow.....	C-5510	Fuel Filter.....	FC-5516
CB-564D (COMPACTORS) S/N: D4M1-UP		CB-54 XW (COMPACTORS) w/C4.4 Eng.		Oil Filter Full Flow.....	C-5510
Air Filter Set.....	A-5675-S	Fuel/Water Separator.....	SFC-55170		
Air Filter Primary.....	A-5673				
Air Filter Secondary.....	A-8670				
Hydraulic Oil Filter.....	HC-5504				

MODEL/APPLICATION	SAKURA NO
CATERPILLAR	
CB-64 (COMPACTORS) w/C4.4 Eng.	
Fuel/Water Separator.....	SFC-55170
CD44B (COMPACTORS) w/C3.4 ENG. , 3400	
Cabin Air Filter.....	CA-55150
CD-54 (COMPACTORS) w/3054C Eng.	
Fuel/Water Separator.....	SFC-43040
CHALLENGER 65 (TRACTORS) S/N: 7YC1-1116	
Air Filter Primary.....	A-5558
Air Filter Set.....	A-5544-S
Air Filter Primary.....	A-5543
Air Filter Secondary.....	A-5559
Fuel Filter Secondary.....	FC-5507
Hydraulic Oil Filter.....	HC-5508
Hydraulic Oil Filter.....	HC-5503
Oil Filter Full Flow.....	C-5510
CHALLENGER 65 (TRACTORS) S/N: 7YC1117-1899	
Air Filter Secondary.....	A-5559
Air Filter Primary.....	A-5543
Air Filter Set.....	A-5544-S
Air Filter Primary.....	A-5558
Fuel Filter Secondary.....	FC-5507
Hydraulic Oil Filter.....	HC-5503
Oil Filter Full Flow.....	C-5510
CHALLENGER 65B (TRACTORS) CAT 3306	
Air Filter Secondary.....	A-5534
Air Filter Primary.....	A-5535
Air Filter Set.....	A-5544-S
Air Filter Primary.....	A-5543
Air Filter Set.....	A-5573-S
Fuel Filter Secondary.....	FC-5507
Fuel Filter.....	FC-5501
Hydraulic Oil Filter.....	HC-5508
Hydraulic Oil Filter.....	HC-5506
Hydraulic Oil Filter.....	HC-5503
Oil Filter Full Flow.....	C-5510
CHALLENGER 65B (TRACTORS) S/N: 7YC1900-UP	
Air Filter Secondary.....	A-5559
Air Filter Primary.....	A-5543
Air Filter Set.....	A-5544-S
Air Filter Primary.....	A-5558
Fuel Filter Secondary.....	FC-5507
Hydraulic Oil Filter.....	HC-5503
Oil Filter Full Flow.....	C-5510
CHALLENGER 70C (TRACTORS) CAT 3306TA (S/N: 2YL1-UP)	
Air Filter Secondary.....	A-5534
Air Filter Set.....	A-5522-S
Air Filter Primary.....	A-5509
Air Filter Primary.....	A-5535
Air Filter Set.....	A-5573-S

MODEL/APPLICATION	SAKURA NO
CATERPILLAR	
Fuel Filter.....	F-5505
Fuel Filter Secondary.....	FC-5507
Fuel/Water Separator.....	SF-5704
Hydraulic Oil Filter.....	HC-5503
Oil Filter Full Flow.....	C-5510
CHALLENGER 70C (TRACTORS) w/3306 Eng.	
Air Filter Set.....	A-5573M-S
Air Filter Primary.....	A-5535M
CHALLENGER 75 (TRACTORS) CAT 3176 (S/N: 4CJ1-UP)	
Air Filter Primary.....	A-5509
Air Filter Set.....	A-5522-S
Air Filter Secondary.....	A-5522
Air Filter Primary.....	A-5543
Air Filter Set.....	A-5544-S
Air Filter Primary.....	A-5558
Air Filter Secondary.....	A-5559
Coolant Filter.....	WC-5705
Coolant Filter.....	WC-5708
Fuel Filter.....	FC-5509
Hydraulic Oil Filter.....	HC-5503
Hydraulic Oil Filter.....	HC-5508
Oil Filter Full Flow.....	C-5516
CHALLENGER 85C (TRACTORS) CAT (S/N: 43Z2487-UP)	
Fuel Filter.....	FC-5509
Oil Filter Full Flow.....	C-5516
CHALLENGER 85C (TRACTORS) CAT (S/N: 43Z720-2486-UP)	
Fuel Filter.....	FC-5509
Oil Filter Full Flow.....	C-5516
CHALLENGER 85C (TRACTORS) CAT 3176 (S/N: 9TK1-1399)	
Air Filter Set.....	A-5555-S
Air Filter Secondary.....	A-5522
Air Filter Set.....	A-5522-S
Air Filter Primary.....	A-5509
Air Filter Secondary.....	A-5556
Air Filter Primary.....	A-5555
Coolant Filter.....	WC-5708
Coolant Filter.....	WC-5705
Fuel Filter.....	FC-5509
Fuel Filter.....	FC-5519
Hydraulic Oil Filter.....	HC-5503
Oil Filter Full Flow.....	C-5516
CHALLENGER 85C (TRACTORS) CAT 3176 (S/N: 9TK1400-UP)	
Air Filter Primary.....	A-5555
Air Filter Secondary.....	A-5556
Air Filter Primary.....	A-5509
Air Filter Set.....	A-5522-S
Air Filter Secondary.....	A-5522
Air Filter Set.....	A-5555-S
Coolant Filter.....	WC-5705
Coolant Filter.....	WC-5708
Fuel Filter.....	FC-5519
Fuel Filter.....	FC-5509
Hydraulic Oil Filter.....	HC-5503

MODEL/APPLICATION	SAKURA NO
CATERPILLAR	
Oil Filter Full Flow.....	C-5516
CHALLENGER 85C (TRACTORS) S/N: 9TK1-UP	
Air Filter Secondary.....	A-5556
Air Filter Primary.....	A-5555
Air Filter Set.....	A-5555-S
Hydraulic Oil Filter.....	HC-5503
Hydraulic Oil Filter.....	HC-5512
Hydraulic Oil Filter.....	HC-5506
CHALLENGER 35 (TRACTORS) CAT 3116 (Excluding S/N: 550, 557, 558, 567)	
Air Filter Set.....	A-5549M-S
Air Filter Secondary.....	A-5550
Air Filter Primary.....	A-5549M
Air Filter Primary.....	A-5549
Air Filter.....	A-5596
Coolant Filter.....	WC-5707
Fuel Filter.....	FC-5508
Fuel Filter.....	FC-5516
Fuel Filter Secondary.....	FC-5515
Fuel Filter Secondary.....	FC-55151
Hydraulic Oil Filter.....	HC-5506
Oil Filter Full Flow.....	C-5510
CHALLENGER 35 (TRACTORS) CAT 3116 (S/N: 8DN1-204)	
Air Filter.....	A-5596
Coolant Filter.....	WC-5707
Fuel Filter Secondary.....	FC-55151
Fuel Filter Secondary.....	FC-5515
Fuel Filter.....	FC-5516
Hydraulic Oil Filter.....	HC-5506
Hydraulic Oil Filter.....	HC-5504
Oil Filter Full Flow.....	C-5510
CHALLENGER 35 (TRACTORS) CAT 3116 (S/N: 8DN205-548)	
Air Filter.....	A-5596
Air Filter Primary.....	A-5549
Air Filter Primary.....	A-5549M
Air Filter Secondary.....	A-5550
Air Filter Set.....	A-5549M-S
Coolant Filter.....	WC-5707
Fuel Filter.....	FC-5516
Fuel Filter Secondary.....	FC-5515
Fuel Filter Secondary.....	FC-55151
Hydraulic Oil Filter.....	HC-5504
Hydraulic Oil Filter.....	HC-5506
Oil Filter Full Flow.....	C-5510
CHALLENGER 35 (TRACTORS) CAT 3116 (S/N: 8DN549-UP)	
Air Filter Set.....	A-5549M-S
Air Filter Secondary.....	A-5550
Air Filter Primary.....	A-5549M
Air Filter Primary.....	A-5549
Air Filter.....	A-5596
Coolant Filter.....	WC-5707
Fuel Filter Secondary.....	FC-55151
Fuel Filter Secondary.....	FC-5515
Fuel Filter.....	FC-5516
Fuel Filter.....	FC-5508

MODEL/APPLICATION	SAKURA NO
CATERPILLAR	
CHALLENGER 35 (TRACTORS) CAT 3116 (S/N: 8DN549-UP)	
Hydraulic Oil Filter.....	HC-5506
Oil Filter Full Flow.....	C-5510
CHALLENGER 36 (TRACTORS) S/N: 8DN205-548	
Air Filter Primary.....	A-5549
Air Filter Primary.....	A-5549M-S
Air Filter Secondary.....	A-5550
Air Filter Set.....	A-5549M-S
Fuel Filter Secondary.....	FC-55151
Fuel Filter Secondary.....	FC-5515
Fuel Filter.....	FC-5516
Hydraulic Oil Filter.....	HC-5506
Hydraulic Oil Filter.....	HC-5504
Oil Filter Full Flow.....	C-5510
CHALLENGER 45 (TRACTORS) CAT 3116 (Excluding S/N: 1117, 1122, 1124,1126)	
Air Filter Set.....	A-5549M-S
Air Filter Primary.....	A-5549M
Air Filter Primary.....	A-5549
Air Filter.....	A-5596
Coolant Filter.....	WC-5707
Fuel Filter.....	FC-5508
Fuel Filter.....	FC-5516
Fuel Filter Secondary.....	FC-5515
Fuel Filter Secondary.....	FC-55151
Hydraulic Oil Filter.....	HC-5506
Oil Filter Full Flow.....	C-5510
CHALLENGER 45 (TRACTORS) CAT 3116 (S/N: 1DR1106-UP)	
Air Filter.....	A-5596
Air Filter Primary.....	A-5549
Air Filter Primary.....	A-5549M
Air Filter Set.....	A-5549M-S
Coolant Filter.....	WC-5707
Fuel Filter Secondary.....	FC-55151
Fuel Filter Secondary.....	FC-5515
Fuel Filter.....	FC-5516
Fuel Filter.....	FC-5508
Hydraulic Oil Filter.....	HC-5506
Oil Filter Full Flow.....	C-5510
CHALLENGER 45 (TRACTORS) CAT 3116 (S/N: 1DR205-1DR1105)	
Air Filter Set.....	A-5549M-S
Air Filter Primary.....	A-5549M
Air Filter Primary.....	A-5549
Air Filter.....	A-5596
Coolant Filter.....	WC-5707
Fuel Filter.....	FC-5516
Fuel Filter Secondary.....	FC-5515
Fuel Filter Secondary.....	FC-55151
Hydraulic Oil Filter.....	HC-5504
Hydraulic Oil Filter.....	HC-5506
Oil Filter Full Flow.....	C-5510
CHALLENGER 55 (TRACTORS) CAT 3126 (S/N: 7DM1-UP)	
Air Filter Primary.....	A-5549

MODEL/APPLICATION	SAKURA NO
CATERPILLAR	
Air Filter Primary.....	A-5549M
Air Filter Set.....	A-5549M-S
Air Filter Secondary.....	A-5550
Fuel Filter Secondary.....	FC-55151
Fuel Filter Secondary.....	FC-5515
Fuel Filter.....	FC-5516
Oil Filter Full Flow.....	C-5510
CHALLENGER 65C (TRACTORS) S/N: 2Z31-1679	
Air Filter Primary.....	A-5535
Air Filter Secondary.....	A-5534
Air Filter Set.....	A-5573-S
Fuel Filter Secondary.....	FC-5507
Hydraulic Oil Filter.....	HC-5503
Oil Filter Full Flow.....	C-5510
CHALLENGER 65C (TRACTORS) w/3306 Eng.	
Air Filter Set.....	A-5573M-S
Air Filter Primary.....	A-5535M
CHALLENGER 65D (TRACTORS) S/N: 2Z31680-1964	
Fuel Filter Secondary.....	FC-5507
CHALLENGER 65D (TRACTORS) S/N: 2Z31965-UP	
Fuel Filter.....	FC-5509
CHALLENGER 65D (TRACTORS) w/3306 Eng.	
Air Filter Primary.....	A-5535M
Air Filter Set.....	A-5573M-S
CHALLENGER 65E (TRACTORS) CAT 3176C	
Air Filter Secondary.....	A-5534
Air Filter Primary.....	A-5535
Air Filter Set.....	A-5573-S
Fuel Filter.....	FC-5509
Fuel Filter.....	FC-5502
Fuel Filter.....	FC-5517
Fuel/Water Separator Secondary..	SFC-5504-10
Fuel/Water Separator Secondary..	SFC-5504-10B
Oil Filter Full Flow.....	C-5516
CHALLENGER 65E (TRACTORS) W/3176 ENG.	
Air Filter Set.....	A-5573M-S
Air Filter Primary.....	A-5535M
CHALLENGER 670 (TRACTORS)	
Fuel Filter.....	FC-5516
Fuel Filter Secondary.....	FC-5515
Fuel Filter Secondary.....	FC-55151
Fuel/Water Separator Secondary..	SFC-5504-10B
Fuel/Water Separator Secondary..	SFC-5504-10
Hydraulic Oil Filter Full Flow.....	HC-79331
Oil Filter Full Flow.....	C-5516
CHALLENGER 75B (TRACTORS) CAT 3176	
Air Filter Secondary.....	A-5534
Air Filter Primary.....	A-5501

MODEL/APPLICATION	SAKURA NO
CATERPILLAR	
Air Filter Secondary.....	A-5502
Air Filter Primary.....	A-5535
Air Filter Set.....	A-5573-S
Coolant Filter.....	WC-5705
Coolant Filter.....	WC-5708
Fuel Filter.....	FC-5509
Fuel/Water Separator Secondary..	SFC-5504-10
Fuel/Water Separator Secondary..	SFC-5504-10B
Hydraulic Oil Filter.....	HC-5508
Hydraulic Oil Filter.....	HC-5503
CHALLENGER 75B (TRACTORS) CAT 3176 (S/N: 4CJ1-UP)	
Air Filter Secondary.....	A-5502
Air Filter Primary.....	A-5501
Air Filter Secondary.....	A-5522
Air Filter Set.....	A-5522-S
Air Filter Primary.....	A-5509
Coolant Filter.....	WC-5705
Coolant Filter.....	WC-5708
Fuel Filter.....	FC-5509
Fuel Filter.....	FC-5519
Hydraulic Oil Filter.....	HC-5503
Hydraulic Oil Filter.....	HC-5508
Oil Filter Full Flow.....	C-5516
CHALLENGER 75C (TRACTORS) CAT 3176 (S/N: 4KK1-4KK1849)	
Air Filter Primary.....	A-5509
Air Filter Set.....	A-5522-S
Air Filter Secondary.....	A-5522
Air Filter Secondary.....	A-5534
Air Filter Primary.....	A-5535
Air Filter Set.....	A-5573-S
Fuel Filter.....	FC-5509
Fuel Filter.....	FC-5519
Hydraulic Oil Filter.....	HC-5508
Hydraulic Oil Filter.....	HC-5503
Oil Filter Full Flow.....	C-5516
CHALLENGER 75C (TRACTORS) CAT 3176 (S/N: 4KK1850-UP)	
Air Filter Set.....	A-5573-S
Air Filter Primary.....	A-5535
Air Filter Secondary.....	A-5534
Air Filter Secondary.....	A-5522
Air Filter Set.....	A-5522-S
Air Filter Primary.....	A-5509
Fuel Filter.....	FC-5519
Fuel Filter.....	FC-5509
Hydraulic Oil Filter.....	HC-5503
Hydraulic Oil Filter.....	HC-5508
Oil Filter Full Flow.....	C-5516
CHALLENGER 75C (TRACTORS) W/3176 ENG.	
Air Filter Primary.....	A-5535M
Air Filter Set.....	A-5573M-S
CHALLENGER 85D (TRACTORS) CAT 3196 (S/N: 4GR1-UP)	
Air Filter Set.....	A-5555-S
Air Filter Primary.....	A-5555
Air Filter Secondary.....	A-5556

Sakura Filter

ENGINE APPLICATION

MODEL/APPLICATION	SAKURA NO	MODEL/APPLICATION	SAKURA NO	MODEL/APPLICATION	SAKURA NO
CATERPILLAR		CATERPILLAR		CATERPILLAR	
CHALLENGER 85D (TRACTORS) CAT 3196 (S/N: 4GR1-UP)		Air Filter Set.....	A-5573-S	CP-323D (COMPACTORS) CAT (S/N: CRS1-UP)	
Fuel Filter.....	FC-5509	Hydraulic Oil Filter.....	HC-5504	Oil Filter Full Flow.....	C-5102
Hydraulic Oil Filter.....	HC-5503	Oil Filter Full Flow.....	C-5516		
Oil Filter Full Flow.....	C-5516	CHALLENGER MT835 (TRACTORS)		CP-323D (COMPACTORS) CAT (S/N: G4D1-UP)	
CHALLENGER 85E (TRACTORS) CAT 3196		Oil Filter Full Flow.....	C-5516	Oil Filter Full Flow.....	C-5102
Air Filter Secondary.....	A-5556	CHALLENGER MT845 (TRACTORS)		CP-323D (COMPACTORS) S/N: EAS1-UP	
Air Filter Primary.....	A-5555	Air Filter Set.....	A-5555-S	Air Filter Primary.....	A-5537
Air Filter Set.....	A-5555-S	Air Filter Primary.....	A-5555	Air Filter Secondary.....	A-5536
Fuel/Water Separator Secondary..	SFC-5504-10B	Air Filter Secondary.....	A-5556	Air Filter Set.....	A-5537-S
Fuel/Water Separator Secondary...	SFC-5504-10	Air Filter Set.....	A-5565-S	Hydraulic Oil Filter.....	HC-5504
Hydraulic Oil Filter.....	HC-5503	Air Filter Primary.....	A-5564		
Hydraulic Oil Filter.....	HC-5506	Air Filter Secondary.....	A-5563	CP-433C (COMPACTORS) CAT 7BJ1-UP , 2011	
Oil Filter Full Flow.....	C-5516	Oil Filter Full Flow.....	C-5516	Air Filter Primary.....	A-56731
CHALLENGER MT265 (TRACTORS)		CHALLENGER MT855 (TRACTORS)		Air Filter Set.....	A-56731-S
Fuel Filter.....	F-5210	Air Filter Secondary.....	A-5556	Air Filter Secondary.....	A-56741
Hydraulic Oil Filter.....	HC-7940	Air Filter Primary.....	A-5555		
CHALLENGER MT285 (TRACTORS)		Air Filter Set.....	A-5555-S	CP-433C (COMPACTORS) CAT 3054T	
Fuel Filter.....	F-5210	Oil Filter Full Flow.....	C-5516	Air Filter Primary.....	A-4210
Hydraulic Oil Filter.....	HC-7940	CHALLENGER MT865 (TRACTORS)		Air Filter Set.....	A-4212-S
CHALLENGER MT425 (TRACTORS)		Oil Filter Full Flow.....	C-5516	Air Filter Secondary.....	A-4211
Air Filter Primary.....	A-6703	CHALLENGER SP110 (TRACTORS)		CP-433C (COMPACTORS) S/N: 2JM1-UP	
Air Filter Primary.....	A-8553	Fuel Filter Secondary.....	FC-7903	Air Filter Primary.....	A-5541
Air Filter.....	A-8554	Fuel/Water Separator.....	SFC-5706	Air Filter Primary.....	A-5541M
Oil Filter Full Flow.....	C-5101	Oil Filter Full Flow.....	C-5703	Air Filter Set.....	A-5541M-S
CHALLENGER MT535 (TRACTORS)		CHALLENGER SP165 (TRACTORS)		Air Filter Primary.....	A-76231
Air Filter Primary.....	A-5105	Fuel Filter Secondary.....	FC-7903	Oil Filter Full Flow.....	C-5102
Air Filter Secondary.....	A-5106	Fuel/Water Separator.....	SFC-5706	CP-433E (COMPACTORS) CAT 7BJ1-UP , 2011	
Oil Filter Full Flow.....	C-5101	Oil Filter Full Flow.....	C-5704	Air Filter Secondary.....	A-56741
CHALLENGER MT565 (TRACTORS)		CHALLENGER 75D (TRACTORS) W/3176 ENG.		Air Filter Set.....	A-56731-S
Air Filter.....	A-5434	Air Filter Primary.....	A-5535M	Air Filter Primary.....	A-56731
Fuel Filter.....	FC-5101	Air Filter Set.....	A-5573M-S	Air Filter Set.....	A-56731-S
Oil Filter Full Flow.....	C-7955	CHALLENGER 75E (TRACTORS) W/3176 ENG.		Air Filter Secondary.....	A-56741
CHALLENGER MT635 (TRACTORS) SISU C8.4L		Air Filter Primary.....	A-5535M	CP-44 (COMPACTORS) CAT C4.4 ACERT , 4400, 2012	
Air Filter.....	A-5434	Air Filter Set.....	A-5573M-S	Air Filter Primary.....	A-56731
Fuel Filter.....	FC-5101	CP-323C (COMPACTORS) CAT 3054 (S/N: EAS1-UP)		Air Filter Set.....	A-56731-S
Hydraulic Oil Filter.....	H-5001	Air Filter Set.....	A-5537-S	Air Filter Secondary.....	A-56741
Oil Filter Full Flow.....	C-7955	Air Filter Secondary.....	A-5536	CP-44 (COMPACTORS) w/C4.4 Eng.	
CHALLENGER MT655 (TRACTORS) SISU C8.4L		Air Filter Primary.....	A-5537	Fuel/Water Separator.....	SFC-55250
Air Filter.....	A-5434	Hydraulic Oil Filter.....	HC-5504	CP-533 (COMPACTORS) S/N: 3ZL1-UP	
Fuel Filter.....	FC-5101	Oil Filter Full Flow.....	C-5102	Fuel Filter Secondary.....	FC-5507
Hydraulic Oil Filter.....	H-5001	CP-323C (COMPACTORS) w/3054B Eng.		Oil Filter Full Flow.....	C-5510
CHALLENGER MT735 (TRACTORS)		Fuel/Water Separator.....	SFC-43040	CP-533D (COMPACTORS) CAT (S/N: 4TF1-UP)	
Oil Filter Full Flow.....	C-5516	CP-323 (COMPACTORS) S/N: 6JD1-UP		Air Filter Set.....	A-5568-S
CHALLENGER MT745 (TRACTORS)		Fuel Filter.....	FC-5103	Air Filter Primary.....	A-5566
Air Filter Secondary.....	A-5534	Oil Filter Full Flow.....	C-5101	Air Filter Secondary.....	A-5567
Air Filter Primary.....	A-5535			Fuel Filter Secondary.....	FC-5507
				Fuel Filter.....	FC-5508

MODEL/APPLICATION	SAKURA NO	MODEL/APPLICATION	SAKURA NO	MODEL/APPLICATION	SAKURA NO
CATERPILLAR		CATERPILLAR		CATERPILLAR	
CP-533D (COMPACTORS) CAT (S/N: 4TF1-UP)		CP-54 (COMPACTORS) CAT C4.4 , 4400, 2012		CP-563E (COMPACTORS) CAT (S/N: CPT1-UP)	
Fuel Filter.....	FC-5516	Air Filter Primary.....	A-56731	Fuel Filter.....	FC-5517
Fuel Filter Secondary.....	FC-55151	Air Filter Set.....	A-56731-S	Oil Filter Full Flow.....	C-5101
Fuel Filter Secondary.....	FC-5515	Air Filter Secondary.....	A-56741	Oil Filter Full Flow.....	C-5522
Oil Filter Full Flow.....	C-5510	CP-54 (COMPACTORS) CAT C4E1-UP , 2011		CP-563E (COMPACTORS) S/N: ASY1-UP	
Oil Filter Full Flow.....	C-5522	Air Filter Primary.....	A-56731	Air Filter Primary.....	A-8508
CP-533D (COMPACTORS) S/N: 6AZ1-UP		Air Filter Secondary.....	A-56741	Air Filter Set.....	A-8508M-S
Air Filter Secondary.....	A-8507	Air Filter Set.....	A-56731-S	Air Filter Secondary.....	A-8507
Air Filter Primary.....	A-8508M	CP-56 (COMPACTORS) w/C6.6 Eng.		Air Filter Set.....	A-8604-S
Air Filter Set.....	A-8604-S	Fuel/Water Separator.....	SFC-55170	Air Filter Primary.....	A-8508M
Air Filter Set.....	A-8508M-S	CP-563 (COMPACTORS) S/N: 1YJ1-UP		Hydraulic Oil Filter.....	HC-5504
Air Filter Primary.....	A-8508	Air Filter Primary.....	A-5507	CP-563E (COMPACTORS) S/N: ASZ1-UP	
Hydraulic Oil Filter.....	HC-5504	Air Filter Set.....	A-5507-S	Air Filter Primary.....	A-8508M
CP-533D (COMPACTORS) S/N: AFC1-UP		Air Filter Set.....	A-55071-S	Air Filter Set.....	A-8604-S
Air Filter Primary.....	A-8508M	Air Filter.....	A-5530	Air Filter Secondary.....	A-8507
Air Filter Primary.....	A-8508	Air Filter Secondary.....	A-5567	Air Filter Set.....	A-8508M-S
Air Filter Set.....	A-8508M-S	Air Filter Primary.....	A-5566	Air Filter Primary.....	A-8508
Air Filter Set.....	A-8604-S	Air Filter Set.....	A-5568-S	Hydraulic Oil Filter.....	HC-5504
Air Filter Secondary.....	A-8507	Fuel Filter Secondary.....	FC-5515	CP-563E (COMPACTORS) S/N: BWE1-UP	
Hydraulic Oil Filter.....	HC-5504	Fuel Filter Secondary.....	FC-55151	Air Filter Primary.....	A-8508
CP-533E (COMPACTORS) CAT (S/N: CRS1-UP)		Fuel Filter.....	FC-5516	Air Filter Set.....	A-8508M-S
Oil Filter Full Flow.....	C-5102	Fuel Filter Secondary.....	FC-5507	Air Filter Secondary.....	A-8507
CP-533E (COMPACTORS) CAT (S/N: G4D1-UP)		Hydraulic Oil Filter.....	HC-5504	Air Filter Set.....	A-8604-S
Oil Filter Full Flow.....	C-5102	Oil Filter Full Flow.....	C-5510	Air Filter Primary.....	A-8508M
CP-533E (COMPACTORS) CAT 3054C		CP-563 (COMPACTORS) S/N: 5AJ1-UP		Hydraulic Oil Filter.....	HC-5504
Air Filter Secondary.....	A-56741	Fuel Filter Secondary.....	FC-5507	CP-563E (COMPACTORS) S/N: CNT1-UP	
Air Filter Set.....	A-56731-S	CP-563 (COMPACTORS) S/N: 8XF1-650		Air Filter Primary.....	A-8508M
Air Filter Primary.....	A-56731	Air Filter Set.....	A-5568-S	Air Filter Set.....	A-8604-S
CP-533E (COMPACTORS) S/N: ASM1-UP		Air Filter Primary.....	A-5566	Air Filter Secondary.....	A-8507
Air Filter Primary.....	A-5673	Air Filter Secondary.....	A-5567	Air Filter Set.....	A-8508M-S
Air Filter Set.....	A-5675-S	Air Filter.....	A-5530	Air Filter Primary.....	A-8508
Air Filter Secondary.....	A-8670	Air Filter Set.....	A-55071-S	Hydraulic Oil Filter.....	HC-5504
Hydraulic Oil Filter.....	HC-5504	Air Filter Set.....	A-5507-S	CP-553 (COMPACTORS) S/N: 7AD90-UP	
CP-533E (COMPACTORS) S/N: BZG1-UP		Air Filter Primary.....	A-5507	Air Filter Secondary.....	A-5408
Air Filter Secondary.....	A-8670	Fuel Filter Secondary.....	FC-5507	Air Filter Primary.....	A-6113
Air Filter Set.....	A-5675-S	Fuel Filter.....	FC-5516	Fuel Filter.....	FC-6503
Air Filter Primary.....	A-5673	Fuel Filter Secondary.....	FC-55151	Oil Filter Full Flow.....	C-7005
Hydraulic Oil Filter.....	HC-5504	Fuel Filter Secondary.....	FC-5515	CP-553 (COMPACTORS) S/N: 7BD1-UP	
CP-533E (COMPACTORS) S/N: DAM1-UP		Hydraulic Oil Filter.....	H-7916	Hydraulic Oil Filter.....	HC-69031
Air Filter Secondary.....	A-8670	Oil Filter Full Flow.....	C-5510	CP-553 (COMPACTORS) S/N: 7BD22-UP	
Air Filter Primary.....	A-5673	CP-563C (COMPACTORS) S/N: 5JN1-UP		Air Filter Primary.....	A-6113
Air Filter Set.....	A-5675-S	Air Filter Set.....	A-5568-S	Air Filter Secondary.....	A-5408
Hydraulic Oil Filter.....	HC-5504	Air Filter Primary.....	A-5566	Fuel Filter.....	FC-6503
CP-533E (COMPACTORS) w/3054C Eng.		Air Filter Secondary.....	A-5567	Oil Filter Full Flow.....	C-7005
Fuel/Water Separator.....	SFC-43040	Fuel Filter.....	FC-5516	CP-553 (COMPACTORS) S/N: 8CD1-UP	
		Fuel Filter Secondary.....	FC-55151	Hydraulic Oil Filter.....	HC-69031
		Fuel Filter Secondary.....	FC-5515	CP-563D (COMPACTORS) CAT S/N: 4TF44156-UP	
		Hydraulic Oil Filter.....	HC-5504		
		Oil Filter Full Flow.....	C-5510		

MODEL/APPLICATION	SAKURA NO	MODEL/APPLICATION	SAKURA NO	MODEL/APPLICATION	SAKURA NO
CATERPILLAR		CATERPILLAR		CATERPILLAR	
CP-563D (COMPACTORS) CAT S/N: 4TF44156-UP Fuel Filter Secondary..... FC-55151 Fuel Filter..... FC-5508 Fuel Filter..... FC-5516 Fuel Filter Secondary..... FC-5515 Oil Filter Full Flow..... C-5522		CP-663E (COMPACTORS) CAT 3056 (S/N: DAF1-UP) Air Filter Set..... A-8508M-S Air Filter Primary..... A-8508 Air Filter Primary..... A-8508M Air Filter Set..... A-8604-S Hydraulic Oil Filter..... HC-5504 Oil Filter Full Flow..... C-5101		CS-423E (COMPACTORS) CAT 3054B (S/N: DCL1-UP) Air Filter Secondary..... A-5540 Hydraulic Oil Filter..... HC-5504 Oil Filter Full Flow..... C-5102	
CP-563D (COMPACTORS) CAT S/N: 98Z29296-38205-UP Fuel Filter..... FC-5508 Fuel Filter Secondary..... FC-55151 Fuel Filter Secondary..... FC-5515 Fuel Filter..... FC-5516 Oil Filter Full Flow..... C-5522		CP-74 (COMPACTORS) w/C6.6 Eng. Fuel/Water Separator..... SFC-55170		CS-423E (COMPACTORS) w/3054C Eng. Fuel/Water Separator..... SFC-43040	
CP-563D (COMPACTORS) S/N: 5LZ1-UP Air Filter Primary..... A-8508M Air Filter Set..... A-8604-S Air Filter Secondary..... A-8507 Air Filter Set..... A-8508M-S Air Filter Primary..... A-8508 Hydraulic Oil Filter..... HC-5504		CP-76 (COMPACTORS) w/C6.6 Eng. Fuel/Water Separator..... SFC-55170		CS-431C (COMPACTORS) CAT 7BJ1-UP , 2011 Air Filter Primary..... A-56731 Air Filter Secondary..... A-56741 Air Filter Set..... A-56731-S	
CP-563D (COMPACTORS) S/N: 92W1-122-UP Air Filter Set..... A-8604-S Air Filter Primary..... A-8508M Air Filter Secondary..... A-8507 Air Filter Primary..... A-8508 Air Filter Set..... A-8508M-S Hydraulic Oil Filter..... HC-5504		CP-72 (COMPACTORS) w/C6.6 Eng. Fuel/Water Separator..... SFC-55170		CS-431C (COMPACTORS) CAT (S/N: 5HK20500-UP) Oil Filter Full Flow..... C-5102 Oil Filter Full Flow..... C-5101	
CP-563D (COMPACTORS) S/N: 92W1-122-UP Air Filter Set..... A-8604-S Air Filter Primary..... A-8508M Air Filter Secondary..... A-8507 Air Filter Primary..... A-8508 Air Filter Set..... A-8508M-S Hydraulic Oil Filter..... HC-5504		CP-74B (COMPACTORS) C7.1 Oil Filter Full Flow..... C-51070		CS-431C (COMPACTORS) CAT (S/N: 7BJ1-UP) Air Filter Set..... A-5675-S Air Filter Secondary..... A-8670 Air Filter Primary..... A-5673 Oil Filter Full Flow..... C-5101 Oil Filter Full Flow..... C-5102	
CP-563D (COMPACTORS) S/N: 92W123-581-UP Air Filter Set..... A-8508M-S Air Filter Primary..... A-8508 Air Filter Secondary..... A-8507 Air Filter Primary..... A-8508M Air Filter Set..... A-8604-S Hydraulic Oil Filter..... HC-5504		CP-76B (COMPACTORS) C7.1 Oil Filter Full Flow..... C-51070		CS-431C (COMPACTORS) CAT (S/N: 9RM1-UP) Oil Filter Full Flow..... C-5102 Oil Filter Full Flow..... C-5101	
CP-563D (COMPACTORS) S/N: 92W582-UP Air Filter Set..... A-8604-S Air Filter Primary..... A-8508M Air Filter Secondary..... A-8507 Air Filter Primary..... A-8508 Air Filter Set..... A-8508M-S Hydraulic Oil Filter..... HC-5504		CS-323C (COMPACTORS) CAT 3054 (S/N: DAR1-UP) Air Filter Set..... A-5537-S Air Filter Secondary..... A-5536 Air Filter Primary..... A-5537 Hydraulic Oil Filter..... HC-5504 Oil Filter Full Flow..... C-5102		CS-431C (COMPACTORS) CAT 3054T Air Filter Secondary..... A-4211 Air Filter Set..... A-4212-S Air Filter Primary..... A-4210	
CP-64 (COMPACTORS) w/C6.6 Eng. Fuel/Water Separator..... SFC-55170		CS-323C (COMPACTORS) w/3054B Eng. Fuel/Water Separator..... SFC-43040		CS-431C (COMPACTORS) S/N: 3WZ1-UP Air Filter Primary..... A-76231 Air Filter Secondary..... A-5540 Air Filter Set..... A-5541M-S Air Filter Primary..... A-5541M Air Filter Primary..... A-5541 Hydraulic Oil Filter..... HC-5504	
CP-663E (COMPACTORS) CAT 3056 (S/N: ASF1-UP) Air Filter Set..... A-8604-S Air Filter Primary..... A-8508M Air Filter Primary..... A-8508 Air Filter Set..... A-8508M-S Hydraulic Oil Filter..... HC-5504 Oil Filter Full Flow..... C-5101		CS-323 (COMPACTORS) S/N: 6JD1-UP Fuel Filter..... FC-5103 Oil Filter Full Flow..... C-5101		CS-431C (COMPACTORS) S/N: 9XL1-UP Air Filter Primary..... A-76600 Hydraulic Oil Filter..... HC-5504	
		CS-323D (COMPACTORS) CAT (S/N: CRS1-UP) Oil Filter Full Flow..... C-5102		CS-431C (COMPACTORS) S/N: 9XL204-UP Air Filter Primary..... A-76231 Air Filter Set..... A-5541M-S Air Filter Primary..... A-5541 Air Filter Primary..... A-5541M Air Filter Secondary..... A-5540 Hydraulic Oil Filter..... HC-5504	
		CS-323D (COMPACTORS) CAT (S/N: G4D1-UP) Oil Filter Full Flow..... C-5102		CS-431C (COMPACTORS) S/N: GEN1-UP Air Filter Secondary..... A-5540	

MODEL/APPLICATION	SAKURA NO	MODEL/APPLICATION	SAKURA NO	MODEL/APPLICATION	SAKURA NO
CATERPILLAR		CATERPILLAR		CATERPILLAR	
CS-431C (COMPACTORS) S/N: GEN1-UP		Air Filter Secondary.....	A-56741	Air Filter Primary.....	A-5566
Air Filter Primary.....	A-5541M	Air Filter Primary.....	A-56731	Air Filter Set.....	A-5568-S
Air Filter Primary.....	A-5541	CS-433E (COMPACTORS) CAT 7BJ1-UP , 2011		Fuel Filter Secondary.....	FC-5507
Air Filter Set.....	A-5541M-S	Air Filter Secondary.....	A-56741	Hydraulic Oil Filter.....	HC-5504
Air Filter Primary.....	A-76600	Air Filter Set.....	A-56731-S	Oil Filter Full Flow.....	C-5510
Air Filter Primary.....	A-76231	Air Filter Primary.....	A-56731	CS-531C (COMPACTORS) CAT (S/N: 4TF17600-42391-UP)	
Hydraulic Oil Filter.....	HC-5504	CS-433E (COMPACTORS) CAT 3054 (S/N: DAC1-UP)		Fuel Filter Secondary.....	FC-55151
CS-433C (COMPACTORS) CAT 5HK1 - 12999 , 2011		Air Filter Secondary.....	A-5540	Fuel Filter Secondary.....	FC-5515
Air Filter Set.....	A-56731-S	Hydraulic Oil Filter.....	HC-5504	Fuel Filter.....	FC-5516
Air Filter Secondary.....	A-56741	Oil Filter Full Flow.....	C-5102	Oil Filter Full Flow.....	C-5510
Air Filter Primary.....	A-56731	CS-433E (COMPACTORS) w/3054C Eng.		CS-531C (COMPACTORS) CAT (S/N: 4TF42392-UP)	
CS-433C (COMPACTORS) CAT 5HK13000 - UP , 2011		Fuel/Water Separator.....	SFC-43040	Fuel Filter.....	FC-5516
Air Filter Set.....	A-56731-S	CS-433 (COMPACTORS) S/N: 2JM1-UP		Fuel Filter Secondary.....	FC-5515
Air Filter Primary.....	A-56731	Air Filter Primary.....	A-76600	Fuel Filter Secondary.....	FC-55151
Air Filter Secondary.....	A-56741	Hydraulic Oil Filter.....	HC-5504	Fuel Filter.....	FC-5508
CS-433C (COMPACTORS) CAT 7BJ1-UP , 2011		Oil Filter Full Flow.....	C-5102	Oil Filter Full Flow.....	C-5510
Air Filter Secondary.....	A-56741	CS-433 (COMPACTORS) S/N: 3TM1-UP		CS-531C (COMPACTORS) CAT (S/N: 98Z16285-23026-UP)	
Air Filter Primary.....	A-56731	Air Filter Primary.....	A-76600	Fuel Filter Secondary.....	FC-55151
Air Filter Set.....	A-56731-S	Hydraulic Oil Filter.....	HC-5504	Fuel Filter Secondary.....	FC-5515
CS-433C (COMPACTORS) CAT 9RM1 - UP , 2011		Oil Filter Full Flow.....	C-5102	Fuel Filter.....	FC-5516
Air Filter Set.....	A-56731-S	CS-433B (COMPACTORS) S/N: 1MG1-UP		CS-531C (COMPACTORS) CAT (S/N: 98Z23027-UP)	
Air Filter Primary.....	A-56731	Air Filter Primary.....	A-76600	Fuel Filter.....	FC-5516
Air Filter Secondary.....	A-56741	Hydraulic Oil Filter.....	HC-5504	Fuel Filter Secondary.....	FC-5515
CS-433C (COMPACTORS) CAT 3054NA		Oil Filter Full Flow.....	C-5102	Fuel Filter Secondary.....	FC-55151
Air Filter Primary.....	A-76600	CS-433B (COMPACTORS) S/N: 4FK1-UP		Fuel Filter.....	FC-5508
Oil Filter Full Flow.....	C-5102	Oil Filter Full Flow.....	C-5101	CS-531C (COMPACTORS) CAT (S/N: 98Z8537-16284-UP)	
CS-433C (COMPACTORS) CAT 3054T		CS-44 (COMPACTORS) CAT C4.4 ACERT , 4400, 2012		Fuel Filter Secondary.....	FC-55151
Air Filter Primary.....	A-4210	Air Filter Primary.....	A-56731	Fuel Filter Secondary.....	FC-5515
Air Filter Set.....	A-4212-S	Air Filter Set.....	A-56731-S	Fuel Filter.....	FC-5516
Air Filter Secondary.....	A-4211	Air Filter Secondary.....	A-56741	Oil Filter Full Flow.....	C-5510
Air Filter Primary.....	A-76600	CS-44 (COMPACTORS) w/C4.4 Eng.		Oil Filter Full Flow.....	C-5522
Oil Filter Full Flow.....	C-5102	Fuel/Water Separator.....	SFC-55250	CS-531C (COMPACTORS) S/N: 5ZN1-171-UP	
CS-433C (COMPACTORS) CAT 5HK1 - 12999		CS-563 (COMPACTORS) S/N: 7GG1-UP		Air Filter Primary.....	A-5566
Air Filter Secondary.....	A-56741	Fuel Filter Secondary.....	FC-5507	Air Filter Secondary.....	A-5567
Air Filter Set.....	A-56731-S	Hydraulic Oil Filter.....	H-7916	Air Filter Set.....	A-5568-S
Air Filter Primary.....	A-56731	Oil Filter Full Flow.....	C-5510	Hydraulic Oil Filter.....	HC-5504
CS-433C (COMPACTORS) CAT 5HK13000 - UP		CS-563 (COMPACTORS) S/N: 8XF1-UP		CS-531C (COMPACTORS) S/N: 5ZN172-UP	
Air Filter Secondary.....	A-56741	Fuel Filter Secondary.....	FC-5507	Air Filter Set.....	A-5568-S
Air Filter Set.....	A-56731-S	Hydraulic Oil Filter.....	H-7916	Air Filter Secondary.....	A-5567
Air Filter Primary.....	A-56731	Oil Filter Full Flow.....	C-5510	Air Filter Primary.....	A-5566
CS-433C (COMPACTORS) CAT 7BJ1-UP		CS-563 (COMPACTORS) S/N: 8XF651-UP		Hydraulic Oil Filter.....	HC-5504
Air Filter Set.....	A-56731-S	Fuel Filter Secondary.....	FC-5507	CS-531C (COMPACTORS) S/N: 9RN1-UP	
Air Filter Primary.....	A-56731	Hydraulic Oil Filter.....	H-7916	Air Filter Set.....	A-5568-S
Air Filter Secondary.....	A-56741	Oil Filter Full Flow.....	C-5510	Air Filter Primary.....	A-5566
CS-433C (COMPACTORS) CAT 9RM1 - UP		CS-563 (COMPACTORS) S/N: 8XF51-UP		Air Filter Secondary.....	A-5567
Air Filter Set.....	A-56731-S	Air Filter Set.....	A-5507-S	Hydraulic Oil Filter.....	HC-5504
Air Filter Primary.....	A-56731	Air Filter Primary.....	A-5507	CS-531D (COMPACTORS) CAT (S/N: 4TF52183-UP)	
Air Filter Secondary.....	A-56741	Air Filter Set.....	A-55071-S	Fuel Filter.....	FC-5516
CS-433C (COMPACTORS) CAT 9RM1 - UP		Air Filter.....	A-5530		
Air Filter Set.....	A-56731-S	Air Filter Secondary.....	A-5567		

MODEL/APPLICATION	SAKURA NO	MODEL/APPLICATION	SAKURA NO	MODEL/APPLICATION	SAKURA NO
CATERPILLAR		CATERPILLAR		CATERPILLAR	
CS-531D (COMPACTORS) CAT (S/N: 4TF52183-UP)		Air Filter Primary.....	A-5566	Air Filter Primary.....	A-8508M
Fuel Filter Secondary.....	FC-5515	Hydraulic Oil Filter.....	HC-5504	Hydraulic Oil Filter.....	HC-5504
Fuel Filter Secondary.....	FC-55151	CS-533C (COMPACTORS) S/N: 2WN184-UP		CS-533E (COMPACTORS) CAT 3116 (S/N: ASL1-UP)	
Fuel Filter.....	FC-5508	Air Filter Primary.....	A-5566	Air Filter Set.....	A-5675-S
Oil Filter Full Flow.....	C-5522	Air Filter Secondary.....	A-5567	Air Filter Primary.....	A-5673
CS-531D (COMPACTORS) S/N: 4MZ1-UP		Air Filter Set.....	A-5568-S	Air Filter Secondary.....	A-8670
Air Filter Primary.....	A-8508	Hydraulic Oil Filter.....	HC-5504	Hydraulic Oil Filter.....	HC-5504
Air Filter Primary.....	A-8508M	CS-533C (COMPACTORS) S/N: 2XN1-458-UP		Oil Filter Full Flow.....	C-5102
Air Filter Secondary.....	A-8507	Air Filter Set.....	A-5568-S	CS-533E (COMPACTORS) CAT 3116 (S/N: DAK1-UP)	
Air Filter Set.....	A-8604-S	Air Filter Secondary.....	A-5567	Air Filter Secondary.....	A-8670
Air Filter Set.....	A-8508M-S	Air Filter Primary.....	A-5566	Air Filter Primary.....	A-5673
Hydraulic Oil Filter.....	HC-5504	Hydraulic Oil Filter.....	HC-5504	Air Filter Set.....	A-5675-S
CS-531D (COMPACTORS) S/N: AGH1-UP		CS-533C (COMPACTORS) S/N: 2XN459-459-UP		Hydraulic Oil Filter.....	HC-5504
Air Filter Primary.....	A-8508M	Air Filter Primary.....	A-5566	Oil Filter Full Flow.....	C-5102
Air Filter Primary.....	A-8508	Air Filter Secondary.....	A-5567	CS-533E (COMPACTORS) CAT 3054C	
Air Filter Set.....	A-8508M-S	Air Filter Set.....	A-5568-S	Air Filter Primary.....	A-56731
Air Filter Set.....	A-8604-S	Hydraulic Oil Filter.....	HC-5504	Air Filter Secondary.....	A-56741
Air Filter Secondary.....	A-8507	CS-533C (COMPACTORS) S/N: 2XN460-490-UP		Air Filter Set.....	A-56731-S
Hydraulic Oil Filter.....	HC-5504	Air Filter Set.....	A-5568-S	CS-533E (COMPACTORS) w/3054C Eng.	
CS-533C (COMPACTORS) CATERPILLAR		Air Filter Secondary.....	A-5567	Fuel/Water Separator.....	SFC-43040
Fuel Filter Secondary.....	FC-55151	Air Filter Primary.....	A-5566	CS-54 (COMPACTORS) CAT C4.4 , 4400, 2012	
Fuel Filter Secondary.....	FC-5515	Hydraulic Oil Filter.....	HC-5504	Air Filter Primary.....	A-56731
Fuel Filter.....	FC-5516	CS-533C (COMPACTORS) S/N: 2XN491-UP		Air Filter Set.....	A-56731-S
Oil Filter Full Flow.....	C-5522	Air Filter Primary.....	A-5566	Air Filter Secondary.....	A-56741
Oil Filter Full Flow.....	C-5510	Air Filter Secondary.....	A-5567	CS-56 (COMPACTORS) w/C6.6 Eng.	
CS-533C (COMPACTORS) CAT (S/N: 4TF20600-42391-UP)		Air Filter Set.....	A-5568-S	Fuel/Water Separator.....	SFC-55170
Fuel Filter.....	FC-5516	Hydraulic Oil Filter.....	HC-5504	CS-563C (COMPACTORS) S/N: 4KN1-UP	
Fuel Filter Secondary.....	FC-5515	CS-533D (COMPACTORS) CAT (S/N: 4TF1-UP)		Air Filter Secondary.....	A-5567
Fuel Filter Secondary.....	FC-55151	Air Filter Set.....	A-5568-S	Air Filter Primary.....	A-5566
Fuel Filter Secondary.....	FC-55151	Air Filter Primary.....	A-5566	Air Filter Set.....	A-5568-S
Fuel Filter.....	FC-5516	Air Filter Secondary.....	A-5567	Fuel Filter Secondary.....	FC-55151
Oil Filter Full Flow.....	C-5510	Fuel Filter.....	FC-5516	Fuel Filter Secondary.....	FC-5515
CS-533C (COMPACTORS) CAT (S/N: 98Z16285-23026-UP)		Fuel Filter Secondary.....	FC-55151	Fuel Filter.....	FC-5516
Fuel Filter.....	FC-5516	Fuel Filter Secondary.....	FC-5515	Hydraulic Oil Filter.....	HC-5504
Fuel Filter Secondary.....	FC-5515	Oil Filter Full Flow.....	C-5510	Oil Filter Full Flow.....	C-5510
Fuel Filter Secondary.....	FC-55151	Oil Filter Full Flow.....	C-5522	CS-563D (COMPACTORS) CAT (S/N: 98Z1-20404-UP)	
CS-533C (COMPACTORS) CAT (S/N: 4TF42392-UP)		CS-533D (COMPACTORS) S/N: 5CZ1-UP		Oil Filter Full Flow.....	C-5522
Fuel Filter.....	FC-5508	Air Filter Set.....	A-8604-S	CS-563D (COMPACTORS) CAT S/N: 4TF44156-UP	
Fuel Filter Secondary.....	FC-55151	Air Filter Secondary.....	A-8507	Fuel Filter.....	FC-5516
Fuel Filter Secondary.....	FC-5515	Air Filter Primary.....	A-8508M	Fuel Filter.....	FC-5508
Fuel Filter.....	FC-5516	Air Filter Primary.....	A-8508	Fuel Filter Secondary.....	FC-5515
Oil Filter Full Flow.....	C-5510	Air Filter Set.....	A-8508M-S	Fuel Filter Secondary.....	FC-55151
CS-533C (COMPACTORS) S/N: 2WN1-183-UP		Hydraulic Oil Filter.....	HC-5504	Oil Filter Full Flow.....	C-5522
Air Filter Set.....	A-5568-S	CS-533D (COMPACTORS) S/N: AET1-UP		CS-563D (COMPACTORS) CAT S/N: 98Z20405-38205-UP	
Air Filter Secondary.....	A-5567	Air Filter Secondary.....	A-8507	Fuel Filter Secondary.....	FC-55151
CS-533C (COMPACTORS) S/N: 2WN1-183-UP		Air Filter Set.....	A-8604-S	Fuel Filter Secondary.....	FC-5515
Air Filter Set.....	A-5568-S	Air Filter Set.....	A-8508M-S	Fuel Filter.....	FC-5508
Air Filter Secondary.....	A-5567	Air Filter Primary.....	A-8508	CS-563D (COMPACTORS) CAT S/N: 98Z20405-38205-UP	
		Hydraulic Oil Filter.....	HC-5504	Fuel Filter Secondary.....	FC-55151
		CS-533D (COMPACTORS) S/N: AET1-UP		Fuel Filter Secondary.....	FC-5515
		Air Filter Secondary.....	A-8507	Fuel Filter.....	FC-5508
		Air Filter Set.....	A-8604-S		
		Air Filter Set.....	A-8508M-S		
		Air Filter Primary.....	A-8508		

MODEL/APPLICATION	SAKURA NO	MODEL/APPLICATION	SAKURA NO	MODEL/APPLICATION	SAKURA NO
CATERPILLAR		CATERPILLAR		CATERPILLAR	
CS-563D (COMPACTORS) CAT S/N: 98220405-38205-UP	Fuel Filter..... FC-5516 Oil Filter Full Flow..... C-5522	CS-563E (COMPACTORS) CAT 3056E (S/N: ASA1-UP)	Air Filter Primary..... A-8508M Air Filter Primary..... A-8508 Air Filter Set..... A-8508M-S Air Filter Set..... A-8604-S Air Filter Secondary..... A-8507 Hydraulic Oil Filter..... HC-5504 Oil Filter Full Flow..... C-5101	Hydraulic Oil Filter..... HC-5504	
CS-563D (COMPACTORS) S/N: 15Z1-20404-UP	Air Filter Secondary..... A-8507 Air Filter Set..... A-8604-S Air Filter Set..... A-8508M-S Air Filter Primary..... A-8508 Air Filter Primary..... A-8508M Hydraulic Oil Filter..... HC-5504 Oil Filter Full Flow..... C-5522 Oil Filter Full Flow..... C-5510	CS-563E (COMPACTORS) CAT 3056E (S/N: CNG1-UP)	Air Filter Secondary..... A-8507 Air Filter Set..... A-8604-S Air Filter Set..... A-8508M-S Air Filter Primary..... A-8508 Air Filter Primary..... A-8508M Hydraulic Oil Filter..... HC-5504 Oil Filter Full Flow..... C-5101	CS-573C (COMPACTORS) S/N: 6LN84-UP	Hydraulic Oil Filter..... HC-5504
CS-563D (COMPACTORS) S/N: 15Z20405-UP	Air Filter Primary..... A-8508M Air Filter Primary..... A-8508 Air Filter Set..... A-8508M-S Air Filter Set..... A-8604-S Air Filter Secondary..... A-8507 Hydraulic Oil Filter..... HC-5504 Oil Filter Full Flow..... C-5510 Oil Filter Full Flow..... C-5522	CS-573C (COMPACTORS) CAT (S/N: 4TF23400-47634-UP)	Air Filter Set..... A-5568-S Air Filter Primary..... A-5566 Air Filter Secondary..... A-5567 Fuel Filter..... FC-5508 Fuel Filter Secondary..... FC-5507 Fuel Filter Secondary..... FC-55151 Fuel Filter Secondary..... FC-5515 Fuel Filter..... FC-5516 Oil Filter Full Flow..... C-5510	CS-573E (COMPACTORS) CAT 3056E (S/N: CEB1-UP)	Air Filter Primary..... A-8508M Air Filter Secondary..... A-8507 Air Filter Set..... A-8604-S Air Filter Set..... A-8508M-S Air Filter Primary..... A-8508 Hydraulic Oil Filter..... HC-5504 Oil Filter Full Flow..... C-5101
CS-563D (COMPACTORS) S/N: 2RZ1-UP	Air Filter Secondary..... A-8507 Air Filter Set..... A-8604-S Air Filter Set..... A-8508M-S Air Filter Primary..... A-8508 Air Filter Primary..... A-8508M Hydraulic Oil Filter..... HC-5504	CS-573C (COMPACTORS) CAT S/N: 4TF1-23399-UP	Air Filter Set..... A-5568-S Air Filter Secondary..... A-5567 Air Filter Primary..... A-5566 Fuel Filter Secondary..... FC-5507 Fuel Filter..... FC-5508 Fuel Filter..... FC-5516 Fuel Filter Secondary..... FC-5515 Fuel Filter Secondary..... FC-55151 Fuel Filter..... FC-5508 Hydraulic Oil Filter..... HC-5504 Oil Filter Full Flow..... C-5510	CS-573E (COMPACTORS) CAT 3056E (S/N: CNN1-UP)	Air Filter Primary..... A-8508 Air Filter Set..... A-8508M-S Air Filter Set..... A-8604-S Air Filter Secondary..... A-8507 Air Filter Primary..... A-8508M Hydraulic Oil Filter..... HC-5504 Oil Filter Full Flow..... C-5101
CS-563D (COMPACTORS) S/N: 9MW1-144-UP	Air Filter Secondary..... A-8507 Air Filter Primary..... A-8508M Air Filter Primary..... A-8508 Air Filter Set..... A-8508M-S Air Filter Set..... A-8604-S Hydraulic Oil Filter..... HC-5504	CS-573C (COMPACTORS) CAT S/N: 4TF47635-UP	Air Filter Set..... A-5568-S Air Filter Secondary..... A-5567 Air Filter Primary..... A-5566 Fuel Filter Secondary..... FC-5507 Fuel Filter..... FC-5508 Fuel Filter..... FC-5516 Fuel Filter Secondary..... FC-5515 Fuel Filter Secondary..... FC-55151 Fuel Filter..... FC-5508 Oil Filter Full Flow..... C-5510 Oil Filter Full Flow..... C-5522	CS-583C (COMPACTORS)	Air Filter Secondary..... A-5567 Air Filter Primary..... A-5566 Air Filter Set..... A-5568-S Fuel Filter..... FC-5516 Fuel Filter Secondary..... FC-5515 Fuel Filter Secondary..... FC-5515 Fuel Filter..... FC-5508 Hydraulic Oil Filter..... HC-5504 Oil Filter Full Flow..... C-5510
CS-563D (COMPACTORS) S/N: 9MW145-979-UP	Air Filter Set..... A-8604-S Air Filter Set..... A-8508M-S Air Filter Primary..... A-8508 Air Filter Primary..... A-8508M Air Filter Secondary..... A-8507 Hydraulic Oil Filter..... HC-5504	CS-573C (COMPACTORS) CAT S/N: 4TF44156-UP	Air Filter Primary..... A-5566 Air Filter Secondary..... A-5567 Air Filter Set..... A-5568-S Fuel Filter Secondary..... FC-55151 Fuel Filter Secondary..... FC-5515 Fuel Filter..... FC-5516 Fuel Filter Secondary..... FC-55151 Oil Filter Full Flow..... C-5510 Oil Filter Full Flow..... C-5522	CS-583D (COMPACTORS) CAT S/N: 4TF44156-UP	Fuel Filter..... FC-5516 Fuel Filter Secondary..... FC-55151 Fuel Filter Secondary..... FC-5515 Fuel Filter..... FC-5508 Oil Filter Full Flow..... C-5522
CS-563D (COMPACTORS) S/N: 9MW980-UP	Air Filter Secondary..... A-8507 Air Filter Primary..... A-8508M Air Filter Primary..... A-8508 Air Filter Set..... A-8508M-S Air Filter Set..... A-8604-S Hydraulic Oil Filter..... HC-5504	CS-573C (COMPACTORS) S/N: 6LN1-69-UP	Fuel Filter..... FC-5516 Fuel Filter..... FC-5508 Fuel Filter Secondary..... FC-5507 Oil Filter Full Flow..... C-5522 Oil Filter Full Flow..... C-5510	CS-583D (COMPACTORS) S/N: 2CZ1-131-UP	Air Filter Primary..... A-8508M Air Filter Primary..... A-8508 Air Filter Secondary..... A-8507 Air Filter Set..... A-8508M-S Air Filter Set..... A-8604-S Hydraulic Oil Filter..... HC-5504
		CS-573C (COMPACTORS) S/N: 6LN70-83-UP	Hydraulic Oil Filter..... HC-5504	CS-583D (COMPACTORS) S/N: 2CZ132-182-UP	Air Filter Set..... A-8604-S

MODEL/APPLICATION	SAKURA NO	MODEL/APPLICATION	SAKURA NO	MODEL/APPLICATION	SAKURA NO
CATERPILLAR		CATERPILLAR		CATERPILLAR	
CS-583D (COMPACTORS) S/N: 2CZ132-182-UP	Air Filter Set..... A-8508M-S Air Filter Secondary..... A-8507 Air Filter Primary..... A-8508 Air Filter Primary..... A-8508M Hydraulic Oil Filter..... HC-5504	CS-553 (COMPACTORS) S/N: 7BD1-UP	Hydraulic Oil Filter..... HC-69031	Air Filter Primary..... A-8508 Air Filter Set..... A-8508M-S Hydraulic Oil Filter..... HC-5504	
CS-583D (COMPACTORS) S/N: 2CZ183-UP	Air Filter Primary..... A-8508M Air Filter Primary..... A-8508 Air Filter Secondary..... A-8507 Air Filter Set..... A-8508M-S Air Filter Set..... A-8604-S Hydraulic Oil Filter..... HC-5504	CS-553 (COMPACTORS) S/N: 8BD1-UP	Hydraulic Oil Filter..... HC-69031	CS-573D (COMPACTORS) S/N: CMK198-UP	Air Filter Primary..... A-8508M Air Filter Secondary..... A-8507 Air Filter Set..... A-8508M-S Air Filter Primary..... A-8508 Air Filter Set..... A-8604-S Hydraulic Oil Filter..... HC-5504
CS-583D (COMPACTORS) S/N: 3GZ1-UP	Air Filter Set..... A-8604-S Air Filter Set..... A-8508M-S Air Filter Secondary..... A-8507 Air Filter Primary..... A-8508 Air Filter Primary..... A-8508M Hydraulic Oil Filter..... HC-5504	CS-573 (COMPACTORS) CAT (S/N: 4TF13299-42391-UP)	Fuel Filter..... FC-5516 Fuel Filter Secondary..... FC-5515 Fuel Filter Secondary..... FC-55151 Oil Filter Full Flow..... C-5510	CS-583 (COMPACTORS) S/N: 1EL1-UP	Fuel Filter Secondary..... FC-5507 Oil Filter Full Flow..... C-5510
CS-531 (COMPACTORS) S/N: 3WM1-UP	Fuel Filter Secondary..... FC-5507 Oil Filter Full Flow..... C-5510	CS-573 (COMPACTORS) CAT (S/N: 4TF42392-UP)	Fuel Filter Secondary..... FC-55151 Fuel Filter Secondary..... FC-5515 Fuel Filter..... FC-5516 Fuel Filter..... FC-5508 Oil Filter Full Flow..... C-5510	CS-583 (COMPACTORS) S/N: 8YJ1-UP	Fuel Filter Secondary..... FC-5507 Hydraulic Oil Filter..... HC-5504 Oil Filter Full Flow..... C-5510
CS-531 (COMPACTORS) S/N: 4KM1-UP	Fuel Filter Secondary..... FC-5507 Oil Filter Full Flow..... C-5510	CS-573 (COMPACTORS) CAT (S/N: 4TF5805-13298-UP)	Fuel Filter Secondary..... FC-55151 Fuel Filter Secondary..... FC-5515 Fuel Filter..... FC-5516 Fuel Filter..... FC-5508 Oil Filter Full Flow..... C-5522	CS-583E (COMPACTORS) CAT 3056E (S/N: CNX1-UP) , 2004-UP	Air Filter Secondary..... A-8507 Air Filter Primary..... A-8508M Air Filter Primary..... A-8508 Air Filter Set..... A-8508M-S Air Filter Set..... A-8604-S Hydraulic Oil Filter..... HC-5504 Oil Filter Full Flow..... C-5101
CS-533 (COMPACTORS) S/N: 3BL1-UP	Fuel Filter Secondary..... FC-5507 Oil Filter Full Flow..... C-5510	CS-573D (COMPACTORS) CAT S/N: 4TF44156-UP	Fuel Filter Secondary..... FC-55151 Fuel Filter Secondary..... FC-5515 Fuel Filter..... FC-5516 Fuel Filter..... FC-5508 Oil Filter Full Flow..... C-5522	CS-583E (COMPACTORS) CAT 3056E (S/N: DAJ1-UP)	Air Filter Set..... A-8604-S Air Filter Set..... A-8508M-S Air Filter Primary..... A-8508 Air Filter Primary..... A-8508M Air Filter Secondary..... A-8507 Hydraulic Oil Filter..... HC-5504 Oil Filter Full Flow..... C-5101
CS-533 (COMPACTORS) S/N: 4HL1-UP	Fuel Filter Secondary..... FC-5507 Oil Filter Full Flow..... C-5510	CS-573D (COMPACTORS) CAT S/N: 98Z33158-38205-UP	Fuel Filter..... FC-5508 Fuel Filter..... FC-5516 Fuel Filter Secondary..... FC-5515 Fuel Filter Secondary..... FC-55151 Oil Filter Full Flow..... C-5522	CS-533E ASL1 (COMPACTORS) CAT 3116	Air Filter Secondary..... A-56741 Air Filter Set..... A-56731-S Air Filter Primary..... A-56731
CS-551 (COMPACTORS) S/N: 62D114-UP	Air Filter..... A-5708 Air Filter..... AS-5708 Fuel Filter..... FC-5501 Oil Filter Full Flow..... C-5519	CS-573D (COMPACTORS) S/N: 2YZ1-UP	Air Filter Set..... A-8604-S Air Filter Set..... A-8508M-S Air Filter Primary..... A-8508 Air Filter Primary..... A-8508M Air Filter Secondary..... A-8507 Hydraulic Oil Filter..... HC-5504	CS-533E DAK1 (COMPACTORS) CAT 3116	Air Filter Primary..... A-56731 Air Filter Set..... A-56731-S Air Filter Secondary..... A-56741
CS-551 (COMPACTORS) S/N: 6ZD1-UP	Air Filter..... AS-5708 Air Filter..... A-5708 Fuel Filter Secondary..... FC-5507 Hydraulic Oil Filter..... HC-69031 Oil Filter Full Flow..... C-5519	CS-573D (COMPACTORS) S/N: CMK1-197-UP	Air Filter Secondary..... A-8507 Air Filter Primary..... A-8508M Air Filter Set..... A-8604-S	CS-56B (COMPACTORS) C7.1	Oil Filter Full Flow..... C-51070
CS-553 (COMPACTORS) S/N: 7AD1-UP	Hydraulic Oil Filter..... HC-69031	CS-573D (COMPACTORS) S/N: CMK1-197-UP	Air Filter Secondary..... A-8507 Air Filter Primary..... A-8508M Air Filter Set..... A-8604-S	CS-643 (COMPACTORS) CAT S/N: 12Z1-UP	Air Filter Primary..... A-5509 Air Filter Secondary..... A-5522 Air Filter Set..... A-5522-S Fuel Filter Secondary..... FC-5507

Sakura Filter

ENGINE APPLICATION

MODEL/APPLICATION	SAKURA NO	MODEL/APPLICATION	SAKURA NO	MODEL/APPLICATION	SAKURA NO
CATERPILLAR		CATERPILLAR		CATERPILLAR	
CS-643 (COMPACTORS) CAT S/N: 1221-UP Hydraulic Oil Filter..... H-5504 Hydraulic Oil Filter..... H-5506 Oil Filter Full Flow..... C-5522		CS-683E (COMPACTORS) CAT 3056 (S/N: ASG1-UP) Air Filter Primary..... A-8508M Air Filter Primary..... A-8508 Air Filter Set..... A-8508M-S Air Filter Set..... A-8604-S Hydraulic Oil Filter..... HC-5504 Oil Filter Full Flow..... C-5101		CW34 (COMPACTORS) W/C4.4 ENG. (S/N C34, J3H) , 4400 Cabin Air Filter..... CA-55150	
CS-643 (COMPACTORS) CAT S/N: 7FD1-UP Air Filter Set..... A-5522-S Air Filter Secondary..... A-5522 Air Filter Primary..... A-5509 Fuel Filter Secondary..... FC-5507 Hydraulic Oil Filter..... H-5506 Hydraulic Oil Filter..... H-5504 Oil Filter Full Flow..... C-5522		CS-683E (COMPACTORS) CAT 3056 (S/N: DAD1-UP) Air Filter Set..... A-8604-S Air Filter Set..... A-8508M-S Air Filter Primary..... A-8508 Air Filter Primary..... A-8508M Hydraulic Oil Filter..... HC-5504 Oil Filter Full Flow..... C-5101		CW34 (COMPACTORS) W/C4.4 ENG. (S/N CT3, TLJ) , 4400 Cabin Air Filter..... CA-55150	
CS-643 (COMPACTORS) CAT S/N: 7GD1-UP Air Filter Primary..... A-5509 Air Filter Secondary..... A-5522 Air Filter Set..... A-5522-S Fuel Filter Secondary..... FC-5507 Hydraulic Oil Filter..... H-5504 Hydraulic Oil Filter..... H-5506 Oil Filter Full Flow..... C-5522		CS-683E (COMPACTORS) CAT 3056 (S/N: DAD1-UP) Air Filter Set..... A-8604-S Air Filter Set..... A-8508M-S Air Filter Primary..... A-8508 Air Filter Primary..... A-8508M Hydraulic Oil Filter..... HC-5504 Oil Filter Full Flow..... C-5101		D10 (DOZERS) S/N: 76X1-358 Air Filter Primary..... A-5501 Air Filter Secondary..... A-5502 Fuel Filter..... FC-5509 Fuel Filter..... FC-5501 Hydraulic Oil Filter..... H-5503 Oil Filter Full Flow..... C-5516	
CS-643 (COMPACTORS) CAT S/N: 7HD1-UP Air Filter Set..... A-5522-S Air Filter Secondary..... A-5522 Air Filter Primary..... A-5509 Fuel Filter Secondary..... FC-5507 Hydraulic Oil Filter..... H-5504 Hydraulic Oil Filter..... H-5506 Oil Filter Full Flow..... C-5522		CS-68B (COMPACTORS) C7.1 Oil Filter Full Flow..... C-51070		D10 (DOZERS) S/N: 76X359-UP Air Filter Primary..... A-5521 Air Filter Secondary..... A-5534 Air Filter Set..... A-5521-S Air Filter Set..... A-5573-S Air Filter Secondary..... A-5552 Air Filter Primary..... A-5535 Fuel Filter..... FC-5501 Fuel Filter..... FC-5509 Fuel Filter..... FC-5519 Hydraulic Oil Filter..... H-5503 Oil Filter Full Flow..... C-5516	
CS-643 (COMPACTORS) CAT S/N: 7JD1-UP Air Filter Set..... A-5522-S Air Filter Secondary..... A-5522 Air Filter Primary..... A-5509 Fuel Filter Secondary..... FC-5507 Hydraulic Oil Filter..... H-5506 Hydraulic Oil Filter..... H-5504 Oil Filter Full Flow..... C-5522		CS-68B (COMPACTORS) w/C6.6 Eng. Fuel/Water Separator..... SFC-55170		D10 (DOZERS) S/N: 84W1-609 Air Filter Primary..... A-5535 Air Filter Primary..... A-5501 Air Filter Set..... A-5573-S Air Filter Secondary..... A-5534 Air Filter Secondary..... A-5502 Fuel Filter..... FC-5509 Fuel Filter..... FC-5501 Hydraulic Oil Filter..... H-5503 Oil Filter Full Flow..... C-5516	
CS-643 (COMPACTORS) CAT S/N: 7KD1-UP Air Filter Set..... A-5522-S Air Filter Secondary..... A-5522 Air Filter Primary..... A-5509 Fuel Filter Secondary..... FC-5507 Hydraulic Oil Filter..... H-5506 Hydraulic Oil Filter..... H-5504 Oil Filter Full Flow..... C-5522		CS-74 (COMPACTORS) w/C6.6 Eng. Fuel/Water Separator..... SFC-55170		D10 (DOZERS) S/N: 84W610-640 Air Filter Primary..... A-5521 Air Filter Secondary..... A-5534 Air Filter Set..... A-5521-S Air Filter Set..... A-5573-S Air Filter Secondary..... A-5552 Air Filter Primary..... A-5535 Fuel Filter..... FC-5501 Fuel Filter..... FC-5509 Fuel Filter..... FC-5519 Hydraulic Oil Filter..... H-5503 Oil Filter Full Flow..... C-5516	
CS-643 (COMPACTORS) CAT S/N: 7LD1-UP Air Filter Set..... A-5522-S Air Filter Secondary..... A-5522 Air Filter Primary..... A-5509 Fuel Filter Secondary..... FC-5507 Hydraulic Oil Filter..... H-5506 Hydraulic Oil Filter..... H-5504 Oil Filter Full Flow..... C-5522		CS-76 (COMPACTORS) w/C6.6 Eng. Fuel/Water Separator..... SFC-55170		D10 (DOZERS) S/N: 84W641-645 Air Filter Primary..... A-5501 Air Filter Secondary..... A-5502 Fuel Filter..... FC-5509 Fuel Filter..... FC-5501 Hydraulic Oil Filter..... H-5503	
CS-663E (COMPACTORS) CAT 3056 (S/N: ASB1-UP) Air Filter Set..... A-8604-S Air Filter Set..... A-8508M-S Air Filter Primary..... A-8508 Air Filter Primary..... A-8508M Hydraulic Oil Filter..... HC-5504 Oil Filter Full Flow..... C-5101		CS-77 (COMPACTORS) w/C6.6 Eng. Fuel/Water Separator..... SFC-55170			
CS-663E (COMPACTORS) CAT 3056 (S/N: DAG1-UP) Air Filter Primary..... A-8508M Air Filter Primary..... A-8508 Air Filter Set..... A-8508M-S Air Filter Set..... A-8604-S Hydraulic Oil Filter..... HC-5504 Oil Filter Full Flow..... C-5101		CS-74B (COMPACTORS) C7.1 Oil Filter Full Flow..... C-51070			
		CS-74B (COMPACTORS) w/C6.6 Eng. Oil Filter Full Flow..... C-51070			
		CS-78B (COMPACTORS) w/C6.6 Eng. Oil Filter Full Flow..... C-51070			
		CS-79B (COMPACTORS) w/C6.6 Eng. Oil Filter Full Flow..... C-51070			
		CW34 (COMPACTORS) W/C4.4 ENG. (S/N 3G4) , 4400 Cabin Air Filter..... CA-55150			
		CW34 (COMPACTORS) W/C4.4 ENG. (S/N AL3) , 4400 Cabin Air Filter..... CA-55150			
		CW34 (COMPACTORS) W/C4.4 ENG. (S/N B7L) , 4400 Cabin Air Filter..... CA-55150			

MODEL/APPLICATION	SAKURA NO
CATERPILLAR	
D10 (DOZERS) S/N: 84W641-645 Oil Filter Full Flow.....	C-5516
D10 (DOZERS) S/N: 84W646-UP Air Filter Primary.....	A-5521
Air Filter Secondary.....	A-5534
Air Filter Set.....	A-5521-S
Air Filter Set.....	A-5573-S
Air Filter Secondary.....	A-5552
Air Filter Primary.....	A-5535
Fuel Filter.....	FC-5501
Fuel Filter.....	FC-5509
Fuel Filter.....	FC-5519
Hydraulic Oil Filter.....	H-5503
Oil Filter Full Flow.....	C-5516
D10T (DOZERS) CAT C27 , 2006-UP Air Filter Secondary.....	A-5556
Air Filter Set.....	A-5555-S
Air Filter Primary.....	A-5555
Fuel Filter.....	FC-5510
Hydraulic Oil Filter.....	H-5510
Hydraulic Oil Filter.....	HC-5516
Oil Filter Full Flow.....	C-5516
D10T (DOZERS) CAT C27 Fuel/Water Separator.....	SFC-55250
D10N (DOZERS) S/N: 2YD1-UP Fuel Filter.....	FC-5509
Hydraulic Oil Filter.....	H-5510
Hydraulic Oil Filter.....	H-55270
Hydraulic Oil Filter.....	H-5504
Hydraulic Oil Filter.....	H-5509
Oil Filter Full Flow.....	C-5516
D10N (DOZERS) S/N: 3SK1-UP Air Filter Set.....	A-5595-S
Air Filter Primary.....	A-5593
Fuel Filter.....	FC-5509
Hydraulic Oil Filter.....	H-5504
Hydraulic Oil Filter.....	H-55270
Hydraulic Oil Filter.....	H-5510
Oil Filter Full Flow.....	C-5516
D10N (DOZERS) S/N: 3SK619-UP Air Filter Primary.....	A-5593
Air Filter Set.....	A-5595-S
Air Filter Secondary.....	A-5594
Cabin Air Filter.....	CA-5501
Hydraulic Oil Filter.....	H-5510
Hydraulic Oil Filter.....	H-55270
Hydraulic Oil Filter.....	HC-5504
D10R (DOZERS) CAT (S/N: 5JJ1-UP) Fuel Filter.....	FC-5509
Oil Filter Full Flow.....	C-5516

MODEL/APPLICATION	SAKURA NO
CATERPILLAR	
D10R (DOZERS) CAT (S/N: 80M1-UP) Fuel Filter.....	FC-5509
Fuel Filter.....	FC-5517
Oil Filter Full Flow.....	C-5516
D10R (DOZERS) CAT (S/N: 9EA1-UP) Hydraulic Oil Filter.....	H-5501
D10R (DOZERS) CAT 3412 (S/N: 3KR1-UP) Air Filter Primary.....	A-5593
Air Filter Secondary.....	A-5594
Air Filter Set.....	A-5595-S
Fuel Filter.....	FC-5509
Fuel/Water Separator Secondary... SFC-5504-10	
Fuel/Water Separator Secondary.. SFC-5504-10B	
Hydraulic Oil Filter.....	H-5526
Hydraulic Oil Filter.....	H-5510
Oil Filter Full Flow.....	C-5516
D10R (DOZERS) CAT 3412 (S/N: AKT1-UP) Air Filter Primary.....	A-8506
Air Filter Primary.....	A-5555
Air Filter Set.....	A-5555-S
Air Filter Set.....	A-8506-S
Air Filter Secondary.....	A-5556
Fuel Filter.....	FC-5509
Fuel/Water Separator Secondary.. SFC-5504-10B	
Fuel/Water Separator Secondary... SFC-5504-10	
Hydraulic Oil Filter.....	H-5510
Hydraulic Oil Filter.....	H-55280
Hydraulic Oil Filter.....	H-5001
Hydraulic Oil Filter.....	H-5526
Oil Filter Full Flow.....	C-5516
D10R (DOZERS) CAT 3412E (S/N: 3KR1-UP) Air Filter Primary.....	A-5593
Air Filter Set.....	A-5595-S
Air Filter Secondary.....	A-5594
Fuel Filter.....	FC-5509
Fuel/Water Separator Secondary... SFC-5504-10	
Fuel/Water Separator Secondary.. SFC-5504-10B	
Hydraulic Oil Filter.....	H-5510
Hydraulic Oil Filter.....	H-5526
Oil Filter Full Flow.....	C-5516
D10R (DOZERS) CAT 3412E (S/N: AKT1-UP) Air Filter Secondary.....	A-5556
Air Filter Primary.....	A-8506
Air Filter Set.....	A-5555-S
Air Filter Primary.....	A-5555
Air Filter Set.....	A-8506-S
Fuel Filter.....	FC-5509
Fuel/Water Separator Secondary.. SFC-5504-10B	
Fuel/Water Separator Secondary... SFC-5504-10	
Hydraulic Oil Filter.....	H-5510
Hydraulic Oil Filter.....	H-55280
Hydraulic Oil Filter.....	H-5001

MODEL/APPLICATION	SAKURA NO
CATERPILLAR	
Hydraulic Oil Filter.....	H-5526
Oil Filter Full Flow.....	C-5516
D10R (DOZERS) S/N: 3KR1463-UP Air Filter Secondary.....	A-5594
Air Filter Set.....	A-5595-S
Air Filter Primary.....	A-8506
Air Filter Set.....	A-8506-S
Air Filter Primary.....	A-5593
Fuel/Water Separator Secondary... SFC-5504-10	
Fuel/Water Separator Secondary.. SFC-5504-10B	
Hydraulic Oil Filter.....	HC-5504
Hydraulic Oil Filter.....	H-55280
Hydraulic Oil Filter.....	H-5510
Hydraulic Oil Filter.....	H-5526
Hydraulic Oil Filter.....	H-55270
D10R (DOZERS) S/N: 3KR1-619 Air Filter Primary.....	A-5593
Air Filter Set.....	A-8506-S
Air Filter Primary.....	A-8506
Air Filter Set.....	A-5595-S
Air Filter Secondary.....	A-5594
Fuel/Water Separator Secondary.. SFC-5504-10B	
Fuel/Water Separator Secondary... SFC-5504-10	
Hydraulic Oil Filter.....	H-5510
Hydraulic Oil Filter.....	H-55270
Hydraulic Oil Filter.....	HC-5504
D10R (DOZERS) S/N: 3KR620-1462 Air Filter Secondary.....	A-5594
Air Filter Set.....	A-5595-S
Air Filter Primary.....	A-8506
Air Filter Set.....	A-8506-S
Air Filter Primary.....	A-5593
Fuel/Water Separator Secondary... SFC-5504-10	
Fuel/Water Separator Secondary.. SFC-5504-10B	
Hydraulic Oil Filter.....	HC-5504
Hydraulic Oil Filter.....	H-5510
Hydraulic Oil Filter.....	H-55280
Hydraulic Oil Filter.....	H-55270
Hydraulic Oil Filter.....	H-5526
D11N (DOZERS) CAT (S/N: 2GR1-2632-UP) Air Filter Primary.....	A-44220
Air Filter Set.....	A-44240-S
Air Filter Secondary.....	A-44230
Air Filter Secondary.....	A-5715
Air Filter Primary.....	A-5593
Air Filter Set.....	A-5595-S
Air Filter Secondary.....	A-5594
Fuel Filter.....	FC-5510
D11N (DOZERS) CAT (S/N: 2GR2633-UP) Air Filter Secondary.....	A-5594
Air Filter Set.....	A-5595-S
Air Filter Primary.....	A-5593
Air Filter Secondary.....	A-5715
Air Filter Secondary.....	A-44230

Sakura Filter

ENGINE APPLICATION

MODEL/APPLICATION	SAKURA NO	MODEL/APPLICATION	SAKURA NO	MODEL/APPLICATION	SAKURA NO
CATERPILLAR		CATERPILLAR		CATERPILLAR	
D11N (DOZERS) CAT (S/N: 2GR2633-UP) Air Filter Set..... A-44240-S Air Filter Primary..... A-44220 Fuel Filter..... FC-5510		Air Filter Secondary..... A-44230 Fuel Filter..... FC-5510 Hydraulic Oil Filter..... H-5526 Hydraulic Oil Filter..... H-5509		Hydraulic Oil Filter..... H-55270	
D11N (DOZERS) S/N: 4HK1-UP Air Filter Primary..... A-44220 Air Filter Set..... A-44240-S Air Filter Secondary..... A-44230 Air Filter Secondary..... A-5556 Air Filter Set..... A-5555-S Air Filter Primary..... A-5555 Fuel Filter..... FC-5510 Hydraulic Oil Filter..... H-55280 Hydraulic Oil Filter..... H-5526 Hydraulic Oil Filter..... H-5509 Hydraulic Oil Filter..... H-5503		D11R (DOZERS) CAT 3508 (S/N: 9XR1-UP) Air Filter Secondary..... A-44230 Air Filter Primary..... A-44220 Air Filter Set..... A-44240-S Fuel Filter..... FC-5510 Hydraulic Oil Filter..... H-5526 Hydraulic Oil Filter..... H-5001		D11R (DOZERS) S/N: AAF437-UP Air Filter Set..... A-5595-S Air Filter Primary..... A-5593 Air Filter Primary..... A-8506 Air Filter Set..... A-8506-S Hydraulic Oil Filter..... H-55270 Hydraulic Oil Filter..... H-55280 Hydraulic Oil Filter..... H-5526 Hydraulic Oil Filter..... H-5001	
D11N (DOZERS) S/N: 4HX1-UP Air Filter Primary..... A-5555 Air Filter Set..... A-5555-S Air Filter Secondary..... A-5556 Fuel Filter..... FC-5510 Hydraulic Oil Filter..... H-5503 Oil Filter Full Flow..... C-5516		D11R (DOZERS) CAT 3508 (S/N: AAF1-UP) Air Filter Set..... A-44240-S Air Filter Primary..... A-44220 Air Filter Secondary..... A-44230 Fuel Filter..... FC-5510 Hydraulic Oil Filter..... H-5001 Hydraulic Oil Filter..... H-5526		D20D (ARTICULATED TRUCKS) CAT 3116 (S/N: 6NG1-UP) , 2005-UP Air Filter Secondary..... A-5520 Air Filter Set..... A-5544-S Air Filter Primary..... A-5543 Fuel Filter..... F-5505 Fuel Filter..... FC-5516 Fuel Filter Secondary..... FC-5515 Fuel Filter Secondary..... FC-55151 Hydraulic Oil Filter..... H-5503 Hydraulic Oil Filter..... H-5504 Oil Filter Full Flow..... C-5510	
D11N (DOZERS) S/N: 74Z1-UP Air Filter Set..... A-5555-S Air Filter Primary..... A-5555 Air Filter Secondary..... A-5529 Air Filter Primary..... A-5521 Air Filter Set..... A-5521-S Fuel Filter..... FC-5510 Hydraulic Oil Filter..... H-5526 Hydraulic Oil Filter..... H-55280 Hydraulic Oil Filter..... H-5503 Hydraulic Oil Filter..... H-5509		D11R (DOZERS) S/N: 7PZ289-681-UP Air Filter Set..... A-5595-S Air Filter Primary..... A-5593 Air Filter Primary..... A-8506 Air Filter Set..... A-8506-S Hydraulic Oil Filter..... H-55280 Hydraulic Oil Filter..... H-55270 Hydraulic Oil Filter..... H-5526 Hydraulic Oil Filter..... H-5001		D20D (ARTICULATED TRUCKS) CAT 3116 (S/N: 9MG1-UP) , 2005-UP Air Filter Primary..... A-5543 Air Filter Set..... A-5544-S Air Filter Secondary..... A-5520 Fuel Filter Secondary..... FC-55151 Fuel Filter Secondary..... FC-5515 Fuel Filter..... FC-5516 Fuel Filter..... F-5505 Hydraulic Oil Filter..... H-5504 Hydraulic Oil Filter..... H-5503 Oil Filter Full Flow..... C-5510	
D11R (DOZERS) CAT 3508 (S/N: 7PZ1-UP) Air Filter Secondary..... A-44230 Air Filter Set..... A-44240-S Air Filter Primary..... A-44220 Fuel Filter..... FC-5510 Hydraulic Oil Filter..... H-5001 Hydraulic Oil Filter..... H-5526		D11R (DOZERS) S/N: 7PZ682-717-UP Air Filter Set..... A-8506-S Air Filter Primary..... A-8506 Air Filter Primary..... A-5593 Air Filter Set..... A-5595-S Hydraulic Oil Filter..... H-5001 Hydraulic Oil Filter..... H-5526 Hydraulic Oil Filter..... H-55270 Hydraulic Oil Filter..... H-5526 Hydraulic Oil Filter..... H-55280		D20D (ARTICULATED TRUCKS) S/N: 6NG1-UP Air Filter Secondary..... A-5520 Air Filter Set..... A-5544-S Air Filter Primary..... A-5543 Fuel Filter..... FC-5516 Fuel Filter Secondary..... FC-5515 Fuel Filter Secondary..... FC-55151 Fuel Filter..... F-5505 Hydraulic Oil Filter..... H-55280 Hydraulic Oil Filter..... H-5503 Hydraulic Oil Filter..... H-5504 Hydraulic Oil Filter..... H-55270 Hydraulic Oil Filter..... H-5526 Oil Filter Full Flow..... C-5510	
D11R (DOZERS) CAT 3508 (S/N: 8ZR1-UP) Air Filter Secondary..... A-44230 Air Filter Primary..... A-44220 Air Filter Set..... A-44240-S Fuel Filter..... FC-5510 Hydraulic Oil Filter..... H-5509 Hydraulic Oil Filter..... H-5526		D11R (DOZERS) S/N: 7PZ718-UP Air Filter Set..... A-5595-S Air Filter Primary..... A-5593 Air Filter Primary..... A-8506 Air Filter Set..... A-8506-S Hydraulic Oil Filter..... H-55280 Hydraulic Oil Filter..... H-55270 Hydraulic Oil Filter..... H-5526 Hydraulic Oil Filter..... H-5001		D20D (ARTICULATED TRUCKS) S/N: 9MG1-UP Air Filter Primary..... A-5543 Air Filter Set..... A-5544-S Air Filter Secondary..... A-5520 Fuel Filter..... F-5505 Fuel Filter Secondary..... FC-55151 Fuel Filter Secondary..... FC-5515 Fuel Filter..... FC-5516	
D11R (DOZERS) CAT 3508 (S/N: 9TR1-UP) Air Filter Set..... A-44240-S Air Filter Primary..... A-44220		D11R (DOZERS) S/N: AAF1-132-UP Air Filter Set..... A-8506-S Air Filter Primary..... A-8506 Air Filter Primary..... A-5593 Air Filter Set..... A-5595-S Hydraulic Oil Filter..... H-5001 Hydraulic Oil Filter..... H-5526 Hydraulic Oil Filter..... H-55280			

MODEL/APPLICATION	SAKURA NO	MODEL/APPLICATION	SAKURA NO	MODEL/APPLICATION	SAKURA NO
CATERPILLAR		CATERPILLAR		CATERPILLAR	
D20D (ARTICULATED TRUCKS) S/N: 9MG1-UP Hydraulic Oil Filter..... H-5526 Hydraulic Oil Filter..... H-55270 Hydraulic Oil Filter..... H-5504 Hydraulic Oil Filter..... H-5503 Hydraulic Oil Filter..... H-55280 Oil Filter Full Flow..... C-5510		Air Filter Primary..... A-5535 Air Filter Set..... A-5573-S Fuel Filter..... F-5505 Fuel Filter Secondary..... FC-5507 Hydraulic Oil Filter..... H-5504 Hydraulic Oil Filter..... H-5503 Oil Filter Full Flow..... C-5510		Fuel Filter..... F-5505 Fuel Filter Secondary..... FC-5507 Hydraulic Oil Filter..... H-5503 Hydraulic Oil Filter..... H-55280 Hydraulic Oil Filter..... H-5504 Hydraulic Oil Filter..... H-5526 Hydraulic Oil Filter..... H-55270 Oil Filter Full Flow..... C-5510	
D22 (DOZERS) S/N: 9VA1-UP Air Filter Primary..... A-5501 Air Filter Secondary..... A-5502 Hydraulic Oil Filter..... H-5504 Hydraulic Oil Filter..... H-5503 Oil Filter Full Flow..... C-5510		D250E II (ARTICULATED TRUCKS) CAT 3306 (S/N: 4PS1-UP) , 2005-UP Air Filter Set..... A-5573-S Air Filter Primary..... A-5535 Air Filter Secondary..... A-5534 Cabin Air Filter..... CA-55060 Fuel Filter Secondary..... FC-5507 Hydraulic Oil Filter..... H-5504 Oil Filter Full Flow..... C-5510		D25D (ARTICULATED TRUCKS) S/N: 1HK674-UP Air Filter Set..... A-5573-S Air Filter Primary..... A-5535 Air Filter Secondary..... A-5534 Fuel Filter..... F-5505 Hydraulic Oil Filter..... H-5504 Hydraulic Oil Filter..... H-55280 Hydraulic Oil Filter..... H-5503 Hydraulic Oil Filter..... H-55270 Hydraulic Oil Filter..... H-5526 Oil Filter Full Flow..... C-5510	
D250E (ARTICULATED TRUCKS) CAT 3306 (S/N: 5TN1-UP) , 2005-UP Air Filter Secondary..... A-5534 Air Filter Primary..... A-5535 Air Filter Set..... A-5573-S Fuel Filter..... F-5505 Fuel Filter Secondary..... FC-5507 Hydraulic Oil Filter..... H-5503 Hydraulic Oil Filter..... H-5504 Oil Filter Full Flow..... C-5510		D25C (ARTICULATED TRUCKS) CAT 3306 (S/N: 9YC1-1011) , 2005-UP Air Filter Secondary..... A-5502 Air Filter Primary..... A-5501 Fuel Filter..... F-5505 Fuel Filter Secondary..... FC-5507 Hydraulic Oil Filter..... H-5503 Hydraulic Oil Filter..... H-5504 Oil Filter Full Flow..... C-5510		D25D (ARTICULATED TRUCKS) S/N: 3AJ1-414 Air Filter Secondary..... A-5534 Air Filter Secondary..... A-5502 Air Filter Primary..... A-5501 Air Filter Primary..... A-5535 Air Filter Set..... A-5573-S Fuel Filter Secondary..... FC-5507 Fuel Filter..... F-5505 Hydraulic Oil Filter..... H-5526 Hydraulic Oil Filter..... H-55270 Hydraulic Oil Filter..... H-5503 Hydraulic Oil Filter..... H-55280 Hydraulic Oil Filter..... H-5504 Oil Filter Full Flow..... C-5510	
D250E (ARTICULATED TRUCKS) S/N: 4PS1-UP Air Filter Set..... A-5573-S Air Filter Primary..... A-5535 Air Filter Secondary..... A-5534 Fuel Filter Secondary..... FC-5507 Fuel Filter..... F-5505 Hydraulic Oil Filter..... H-5526 Hydraulic Oil Filter..... H-55270 Hydraulic Oil Filter..... H-55280 Hydraulic Oil Filter..... H-5504 Hydraulic Oil Filter..... H-5503 Oil Filter Full Flow..... C-5510		D25C (ARTICULATED TRUCKS) CAT 3306 Air Filter Set..... A-44150-S Air Filter Primary..... A-44150		D25D (ARTICULATED TRUCKS) S/N: 3AJ415-UP Air Filter Set..... A-5573-S Air Filter Primary..... A-5535 Air Filter Secondary..... A-5534 Fuel Filter..... F-5505 Hydraulic Oil Filter..... H-55270 Hydraulic Oil Filter..... H-5503 Hydraulic Oil Filter..... H-55280 Hydraulic Oil Filter..... H-5504 Oil Filter Full Flow..... C-5510	
D250E (ARTICULATED TRUCKS) S/N: 5TN1-UP Air Filter Secondary..... A-5534 Air Filter Primary..... A-5535 Air Filter Set..... A-5573-S Fuel Filter..... F-5505 Fuel Filter Secondary..... FC-5507 Hydraulic Oil Filter..... H-5503 Hydraulic Oil Filter..... H-5504 Hydraulic Oil Filter..... H-55280 Hydraulic Oil Filter..... H-55270 Hydraulic Oil Filter..... H-5526 Hydraulic Oil Filter..... H-5510 Oil Filter Full Flow..... C-5510		D25C (ARTICULATED TRUCKS) S/N: 9YC1-1011 Air Filter Primary..... A-5501 Air Filter Secondary..... A-5502 Fuel Filter Secondary..... FC-5507 Fuel Filter..... F-5505 Hydraulic Oil Filter..... H-55280 Hydraulic Oil Filter..... H-55270 Hydraulic Oil Filter..... H-5526 Hydraulic Oil Filter..... H-5504 Hydraulic Oil Filter..... H-5503 Oil Filter Full Flow..... C-5510		D25D (ARTICULATED TRUCKS) S/N: 3AJ415-UP Air Filter Set..... A-5573-S Air Filter Primary..... A-5535 Air Filter Secondary..... A-5534 Fuel Filter..... F-5505 Hydraulic Oil Filter..... H-55270 Hydraulic Oil Filter..... H-5526 Hydraulic Oil Filter..... H-5504 Hydraulic Oil Filter..... H-55280 Hydraulic Oil Filter..... H-5503 Oil Filter Full Flow..... C-5510	
D250E (ARTICULATED TRUCKS) S/N: 5TN1-UP Air Filter Secondary..... A-5534 Air Filter Primary..... A-5535 Air Filter Set..... A-5573-S Fuel Filter..... F-5505 Fuel Filter Secondary..... FC-5507 Hydraulic Oil Filter..... H-5503 Hydraulic Oil Filter..... H-5504 Hydraulic Oil Filter..... H-55280 Hydraulic Oil Filter..... H-55270 Hydraulic Oil Filter..... H-5526 Hydraulic Oil Filter..... H-5510 Oil Filter Full Flow..... C-5510		D25C (ARTICULATED TRUCKS) CAT 3306 (S/N: 1HK-UP) , 2005-UP Air Filter Secondary..... A-5502 Air Filter Secondary..... A-5534 Air Filter Primary..... A-5535 Air Filter Set..... A-5573-S Fuel Filter Secondary..... FC-5507 Hydraulic Oil Filter..... H-5504 Hydraulic Oil Filter..... H-5503 Oil Filter Full Flow..... C-5510		D25D (ARTICULATED TRUCKS) S/N: 9RF1-UP Air Filter Secondary..... A-5534 Air Filter Primary..... A-5501 Air Filter Secondary..... A-5502 Air Filter Primary..... A-5535 Air Filter Set..... A-5573-S Fuel Filter Secondary..... FC-5507 Fuel Filter..... F-5505 Hydraulic Oil Filter..... H-5526 Hydraulic Oil Filter..... H-55270 Hydraulic Oil Filter..... H-5503	
D250E (ARTICULATED TRUCKS) w/3306 Eng. Air Filter Primary..... A-5535M Air Filter Set..... A-5573M-S		D25D (ARTICULATED TRUCKS) S/N: 1HK1-673 Air Filter Secondary..... A-5534 Air Filter Primary..... A-5501 Air Filter Secondary..... A-5502 Air Filter Primary..... A-5535 Air Filter Set..... A-5573-S		D25D (ARTICULATED TRUCKS) S/N: 3AJ415-UP Air Filter Set..... A-5573-S Air Filter Primary..... A-5535 Air Filter Secondary..... A-5534 Fuel Filter..... F-5505 Hydraulic Oil Filter..... H-5526 Hydraulic Oil Filter..... H-55270 Hydraulic Oil Filter..... H-5503	
D250E II (ARTICULATED TRUCKS) CAT 3116 (S/N: 4PS1-UP) , 2005-UP Air Filter Secondary..... A-5534					

MODEL/APPLICATION	SAKURA NO	MODEL/APPLICATION	SAKURA NO	MODEL/APPLICATION	SAKURA NO
CATERPILLAR		CATERPILLAR		CATERPILLAR	
D25D (ARTICULATED TRUCKS) S/N: 9RF1-UP		Fuel Filter.....	F-5505	Hydraulic Oil Filter.....	H-5503
Hydraulic Oil Filter.....	H-55280	Fuel Filter.....	FC-5516	Hydraulic Oil Filter.....	H-5504
Hydraulic Oil Filter.....	H-5504	Fuel Filter Secondary.....	FC-5515	Oil Filter Full Flow.....	C-5510
Oil Filter Full Flow.....	C-5510	Fuel Filter Secondary.....	FC-55151		
D25D (ARTICULATED TRUCKS) w/3306 Eng.		Hydraulic Oil Filter.....	H-5504	D300E (ARTICULATED TRUCKS) CAT 3306 (S/N: 7FN1-UP) , 2005-UP	
Air Filter Set.....	A-5573M-S	Hydraulic Oil Filter.....	H-5503	Air Filter Secondary.....	A-5534
Air Filter Primary.....	A-5535M	Oil Filter Full Flow.....	C-5510	Air Filter Primary.....	A-5535
D250 (ARTICULATED TRUCKS) S/N: 9VA1-UP				Air Filter Set.....	A-5573-S
Air Filter Secondary.....	A-5502	D250D (ARTICULATED TRUCKS) S/N: 6NG1-UP		Fuel Filter.....	F-5505
Air Filter Primary.....	A-5501	Air Filter Secondary.....	A-5520	Fuel Filter Secondary.....	FC-5507
Hydraulic Oil Filter.....	H-5503	Air Filter Set.....	A-5544-S	Hydraulic Oil Filter.....	H-5504
Hydraulic Oil Filter.....	H-5504	Air Filter Primary.....	A-5543	Hydraulic Oil Filter.....	H-5503
Oil Filter Full Flow.....	C-5510	Fuel Filter.....	F-5505	Oil Filter Full Flow.....	C-5510
D250B (ARTICULATED TRUCKS) CAT 3306 (S/N: 5WD1-550) , 2005-UP		Fuel Filter Secondary.....	FC-55151		
Air Filter Primary.....	A-5501	Fuel Filter Secondary.....	FC-5515	D300E (ARTICULATED TRUCKS) S/N: 5KS1-UP	
Air Filter Secondary.....	A-5502	Fuel Filter.....	FC-5516	Air Filter Set.....	A-5573-S
Fuel Filter.....	F-5505	Hydraulic Oil Filter.....	H-5526	Air Filter Primary.....	A-5535
Fuel Filter Secondary.....	FC-5507	Hydraulic Oil Filter.....	H-55270	Air Filter Secondary.....	A-5534
Hydraulic Oil Filter.....	H-5503	Hydraulic Oil Filter.....	H-55280	Fuel Filter Secondary.....	FC-5507
Hydraulic Oil Filter.....	H-5504	Hydraulic Oil Filter.....	H-5503	Fuel Filter.....	F-5505
Oil Filter Full Flow.....	C-5510	Hydraulic Oil Filter.....	H-55280	Hydraulic Oil Filter.....	H-5526
D250B (ARTICULATED TRUCKS) CAT 3306		Hydraulic Oil Filter.....	H-55270	Hydraulic Oil Filter.....	H-5503
Air Filter Primary.....	A-44150	Oil Filter Full Flow.....	C-5510	Hydraulic Oil Filter.....	H-5504
Air Filter Set.....	A-44150-S			Hydraulic Oil Filter.....	H-55280
D250B (ARTICULATED TRUCKS) S/N: 5WD1-550		D250D (ARTICULATED TRUCKS) S/N: 9MG1-UP		Hydraulic Oil Filter.....	H-5504
Air Filter Primary.....	A-5501	Air Filter Primary.....	A-5543	Hydraulic Oil Filter.....	H-55270
Air Filter Secondary.....	A-5502	Air Filter Set.....	A-5544-S	Hydraulic Oil Filter.....	H-5503
Fuel Filter.....	F-5505	Air Filter Secondary.....	A-5520	Hydraulic Oil Filter.....	H-55280
Fuel Filter Secondary.....	FC-5507	Fuel Filter.....	F-5505	Hydraulic Oil Filter.....	H-5504
Hydraulic Oil Filter.....	H-55280	Fuel Filter Secondary.....	FC-5515	Hydraulic Oil Filter.....	H-55270
Hydraulic Oil Filter.....	H-55270	Fuel Filter Secondary.....	FC-55151	Hydraulic Oil Filter.....	H-5503
Hydraulic Oil Filter.....	H-5526	Hydraulic Oil Filter.....	H-5526	Hydraulic Oil Filter.....	H-55280
Hydraulic Oil Filter.....	H-5504	Hydraulic Oil Filter.....	H-5504	Hydraulic Oil Filter.....	H-5504
Hydraulic Oil Filter.....	H-5503	Hydraulic Oil Filter.....	H-55280	Hydraulic Oil Filter.....	H-55270
Oil Filter Full Flow.....	C-5510	Hydraulic Oil Filter.....	H-55270	Hydraulic Oil Filter.....	H-5503
D250D (ARTICULATED TRUCKS) CAT 3116 (S/N: 6NG1-UP) , 2005-UP		Oil Filter Full Flow.....	C-5510	Hydraulic Oil Filter.....	H-5526
Air Filter Secondary.....	A-5520			Oil Filter Full Flow.....	C-5510
Air Filter Set.....	A-5544-S	D250E SERIES II (ARTICULATED TRUCKS)			
Air Filter Primary.....	A-5543	Air Filter Primary.....	A-5535	D300E (ARTICULATED TRUCKS) w/3306 Eng.	
Fuel Filter.....	F-5505	Air Filter Set.....	A-5573-S	Air Filter Set.....	A-5573M-S
Fuel Filter Secondary.....	FC-55151	Fuel Filter.....	F-5505	Air Filter Primary.....	A-5535M
Fuel Filter Secondary.....	FC-5515	Fuel Filter Secondary.....	FC-5507		
Fuel Filter.....	FC-5516	Hydraulic Oil Filter.....	H-5504	D300E II (ARTICULATED TRUCKS) CAT 3306 (S/N: 5KS1-UP) , 2005-UP	
Hydraulic Oil Filter.....	H-5503	Hydraulic Oil Filter.....	H-5504	Air Filter Secondary.....	A-5534
Hydraulic Oil Filter.....	H-5504	Hydraulic Oil Filter.....	H-5503	Air Filter Primary.....	A-5535
Oil Filter Full Flow.....	C-5510	Hydraulic Oil Filter.....	H-55280	Air Filter Set.....	A-5573-S
D250D (ARTICULATED TRUCKS) CAT 3116 (S/N: 9MG1-UP) , 2005-UP		Hydraulic Oil Filter.....	H-55270	Fuel Filter.....	F-5505
Air Filter Primary.....	A-5543	Hydraulic Oil Filter.....	H-55270	Fuel Filter Secondary.....	FC-5507
Air Filter Set.....	A-5544-S	Hydraulic Oil Filter.....	H-5526	Hydraulic Oil Filter.....	H-5503
Air Filter Secondary.....	A-5520	Oil Filter Full Flow.....	C-5510	Hydraulic Oil Filter.....	H-5504
				Oil Filter Full Flow.....	C-5510
		D250E SERIES II (ARTICULATED TRUCKS) w/3306 Eng.			
		Air Filter Primary.....	A-5535M	D30C (ARTICULATED TRUCKS) CAT 3306 (S/N: 72C1-257) , 2005-UP	
		Air Filter Set.....	A-5573M-S	Air Filter Primary.....	A-5501
				Air Filter Secondary.....	A-5502
		D300B (ARTICULATED TRUCKS) CAT 3306 (S/N: 4SD1-573) , 2005-UP		Fuel Filter.....	F-5505
		Air Filter Secondary.....	A-5520		
		Air Filter Primary.....	A-5501		
		Fuel Filter.....	F-5505		
		Fuel Filter Secondary.....	FC-5507		

MODEL/APPLICATION	SAKURA NO
CATERPILLAR	
D30C (ARTICULATED TRUCKS) CAT 3306 (S/N: 7ZC1-257) , 2005-UP	
Fuel Filter Secondary.....	FC-5507
Hydraulic Oil Filter.....	H-5504
Hydraulic Oil Filter.....	H-5503
Oil Filter Full Flow.....	C-5510
D30C (ARTICULATED TRUCKS) CAT 3306	
Air Filter Set.....	A-44150-S
Air Filter Primary.....	A-44150
D30C (ARTICULATED TRUCKS) S/N: 7ZC1-257	
Air Filter Primary.....	A-5501
Air Filter Secondary.....	A-5502
Fuel Filter Secondary.....	FC-5507
Fuel Filter.....	F-5505
Hydraulic Oil Filter.....	H-55280
Hydraulic Oil Filter.....	H-55270
Hydraulic Oil Filter.....	H-5526
Hydraulic Oil Filter.....	H-5503
Hydraulic Oil Filter.....	H-5504
Oil Filter Full Flow.....	C-5510
D30D (ARTICULATED TRUCKS) CAT 3306 (S/N: 3A31-UP) , 2005-UP	
Air Filter Secondary.....	A-5502
Fuel Filter Secondary.....	FC-5507
Hydraulic Oil Filter.....	H-5503
Hydraulic Oil Filter.....	H-5504
Oil Filter Full Flow.....	C-5510
D30D (ARTICULATED TRUCKS) S/N: 1HK1-673	
Air Filter Secondary.....	A-5502
Air Filter Primary.....	A-5501
Air Filter Secondary.....	A-5534
Air Filter Primary.....	A-5535
Air Filter Set.....	A-5573-S
Fuel Filter Secondary.....	FC-5507
Fuel Filter.....	F-5505
Hydraulic Oil Filter.....	H-5504
Hydraulic Oil Filter.....	H-5503
Hydraulic Oil Filter.....	H-55270
Hydraulic Oil Filter.....	H-55280
Hydraulic Oil Filter.....	H-5526
Oil Filter Full Flow.....	C-5510
D30D (ARTICULATED TRUCKS) S/N: 1HK674-UP	
Air Filter Set.....	A-5573-S
Air Filter Primary.....	A-5535
Air Filter Secondary.....	A-5534
Fuel Filter.....	F-5505
Fuel Filter Secondary.....	FC-5507
Hydraulic Oil Filter.....	H-5526
Hydraulic Oil Filter.....	H-55280
Hydraulic Oil Filter.....	H-55270
Hydraulic Oil Filter.....	H-5503
Hydraulic Oil Filter.....	H-5504
Oil Filter Full Flow.....	C-5510

MODEL/APPLICATION	SAKURA NO
CATERPILLAR	
D30D (ARTICULATED TRUCKS) S/N: 3A31-414	
Air Filter Secondary.....	A-5502
Air Filter Secondary.....	A-5534
Air Filter Primary.....	A-5501
Air Filter Primary.....	A-5535
Air Filter Set.....	A-5573-S
Fuel Filter Secondary.....	FC-5507
Fuel Filter.....	F-5505
Hydraulic Oil Filter.....	H-5504
Hydraulic Oil Filter.....	H-5503
Hydraulic Oil Filter.....	H-55270
Hydraulic Oil Filter.....	H-55280
Hydraulic Oil Filter.....	H-5526
Oil Filter Full Flow.....	C-5510
D30D (ARTICULATED TRUCKS) S/N: 3A3415-UP	
Air Filter Set.....	A-5573-S
Air Filter Primary.....	A-5535
Air Filter Secondary.....	A-5534
Fuel Filter.....	F-5505
Fuel Filter Secondary.....	FC-5507
Hydraulic Oil Filter.....	H-5526
Hydraulic Oil Filter.....	H-55280
Hydraulic Oil Filter.....	H-55270
Hydraulic Oil Filter.....	H-5503
Hydraulic Oil Filter.....	H-5504
Oil Filter Full Flow.....	C-5510
D30D (ARTICULATED TRUCKS) S/N: 9RF1-UP	
Air Filter Secondary.....	A-5534
Air Filter Primary.....	A-5501
Air Filter Primary.....	A-5535
Air Filter Set.....	A-5573-S
Air Filter Secondary.....	A-5502
Fuel Filter Secondary.....	FC-5507
Fuel Filter.....	F-5505
Hydraulic Oil Filter.....	H-5504
Hydraulic Oil Filter.....	H-5503
Hydraulic Oil Filter.....	H-55270
Hydraulic Oil Filter.....	H-55280
Hydraulic Oil Filter.....	H-5526
Oil Filter Full Flow.....	C-5510
D30D (ARTICULATED TRUCKS) w/3306 Eng.	
Air Filter Set.....	A-5573M-S
Air Filter Primary.....	A-5535M
D3 (DOZERS) S/N: 27Y-UP	
Air Filter Secondary.....	A-5525
Air Filter Set.....	A-5542-S
Air Filter Primary.....	A-5542
Hydraulic Oil Filter.....	H-5503
Oil Filter Full Flow.....	C-5510
D3 (DOZERS) S/N: 6N1-UP	
Air Filter Primary.....	A-5542
Air Filter Set.....	A-5542-S

MODEL/APPLICATION	SAKURA NO
CATERPILLAR	
Air Filter Secondary.....	A-5525
Hydraulic Oil Filter.....	H-5504
D3 (DOZERS) S/N: 79U1-UP	
Air Filter Secondary.....	A-5525
Air Filter Set.....	A-5542-S
Air Filter Primary.....	A-5542
Fuel Filter.....	FC-5503
Hydraulic Oil Filter.....	H-5504
Oil Filter Full Flow.....	C-5504
D3 (DOZERS) S/N: 82U1-UP	
Air Filter Primary.....	A-5542
Air Filter Set.....	A-5542-S
Air Filter Secondary.....	A-5525
Fuel Filter.....	FC-5503
Oil Filter Full Flow.....	C-5504
D3 (DOZERS) S/N: 83U1-UP	
Air Filter Secondary.....	A-5525
Air Filter Set.....	A-5542-S
Air Filter Primary.....	A-5542
Fuel Filter.....	FC-5503
Oil Filter Full Flow.....	C-5504
D3 (DOZERS) w/3204 Eng.	
Air Filter Secondary.....	A-5590
D300D (ARTICULATED TRUCKS) CAT 3306 (S/N: 5MG1-UP) , 2005-UP	
Air Filter Primary.....	A-5501
Air Filter Secondary.....	A-5502
Fuel Filter.....	F-5505
Fuel Filter Secondary.....	FC-5507
Hydraulic Oil Filter.....	H-5504
Hydraulic Oil Filter.....	H-5503
Oil Filter Full Flow.....	C-5510
D300D (ARTICULATED TRUCKS) S/N: 5MG1-UP	
Air Filter Secondary.....	A-5534
Air Filter Primary.....	A-5501
Air Filter Primary.....	A-5535
Air Filter Set.....	A-5573-S
Fuel Filter Secondary.....	FC-5507
Hydraulic Oil Filter.....	H-5503
Hydraulic Oil Filter.....	H-5504
Oil Filter Full Flow.....	C-5510
D300E SERIES II (ARTICULATED TRUCKS)	
Air Filter Primary.....	A-5535
Air Filter Set.....	A-5573-S
Fuel Filter.....	F-5505
Hydraulic Oil Filter.....	H-5504
Hydraulic Oil Filter.....	H-5503
Hydraulic Oil Filter.....	H-55280
Hydraulic Oil Filter.....	H-55270
Hydraulic Oil Filter.....	H-5526
Oil Filter Full Flow.....	C-5510

MODEL/APPLICATION	SAKURA NO	MODEL/APPLICATION	SAKURA NO	MODEL/APPLICATION	SAKURA NO
CATERPILLAR		CATERPILLAR		CATERPILLAR	
D343A (GENERATORS) S/N: 33812566-UP		Fuel Filter.....	F-5501	Oil Filter Full Flow.....	C-5510
Air Filter.....	A-5506	Oil Filter Full Flow.....	0-5502		
Fuel Filter.....	F-5501			D350D (ARTICULATED TRUCKS) S/N: 3A31-414	
Oil Filter Full Flow.....	0-5503			Air Filter Primary.....	A-5501
		D349 (GENERATORS) S/N: 62P1-UP		Air Filter Secondary.....	A-5502
D343A (GENERATORS) S/N: 3382567-UP		Air Filter.....	A-5518	Air Filter Secondary.....	A-5534
Air Filter.....	A-5506	Fuel Filter.....	F-5501	Air Filter Primary.....	A-5535
Fuel Filter.....	F-5501	Oil Filter Full Flow.....	0-5502	Air Filter Set.....	A-5573-S
Oil Filter Full Flow.....	0-5503			Fuel Filter.....	F-5505
		D349 (GENERATORS) S/N: 67P1-UP		Fuel Filter Secondary.....	FC-5507
D343A (GENERATORS) S/N: 62B1-5886		Air Filter.....	A-5518	Hydraulic Oil Filter.....	H-5504
Air Filter.....	A-5506	Fuel Filter.....	F-5501	Hydraulic Oil Filter.....	H-5503
Fuel Filter.....	F-5501	Oil Filter Full Flow.....	0-5502	Hydraulic Oil Filter.....	H-55280
Oil Filter Full Flow.....	0-5503			Hydraulic Oil Filter.....	H-5526
		D350C (ARTICULATED TRUCKS) CAT 3306 (S/N: 8XC1-404) , 2005-UP		Hydraulic Oil Filter.....	H-55270
D343A (GENERATORS) S/N: 62B5887-UP		Air Filter Secondary.....	A-5502	Oil Filter Full Flow.....	C-5510
Air Filter.....	A-5506	Air Filter Primary.....	A-5501		
Oil Filter Full Flow.....	0-5503	Fuel Filter.....	F-5505	D350D (ARTICULATED TRUCKS) S/N: 9RF1-UP	
		Fuel Filter Secondary.....	FC-5507	Air Filter Primary.....	A-5501
D346 (GENERATORS) S/N: 3931-521		Hydraulic Oil Filter.....	H-5503	Air Filter Set.....	A-5573-S
Air Filter.....	A-5518	Hydraulic Oil Filter.....	H-5504	Air Filter Primary.....	A-5535
Fuel Filter.....	F-5501	Oil Filter Full Flow.....	C-5510	Air Filter Secondary.....	A-5534
Oil Filter Full Flow.....	0-5503			Air Filter Secondary.....	A-5502
		D350C (ARTICULATED TRUCKS) S/N: 8XC1-404		Fuel Filter Secondary.....	FC-5507
D346 (GENERATORS) S/N: 393522-UP		Air Filter Secondary.....	A-5502	Fuel Filter.....	F-5505
Air Filter.....	A-5518	Air Filter Primary.....	A-5501	Hydraulic Oil Filter.....	H-5504
Fuel Filter.....	F-5501	Fuel Filter Secondary.....	FC-5507	Hydraulic Oil Filter.....	H-55270
Oil Filter Full Flow.....	0-5502	Fuel Filter.....	F-5505	Hydraulic Oil Filter.....	H-5526
		Hydraulic Oil Filter.....	H-5526	Hydraulic Oil Filter.....	H-55280
D346 (GENERATORS) S/N: 40J1-245		Hydraulic Oil Filter.....	H-55270	Hydraulic Oil Filter.....	H-5503
Air Filter.....	A-5518	Hydraulic Oil Filter.....	H-55280	Hydraulic Oil Filter.....	H-5503
Fuel Filter.....	F-5501	Hydraulic Oil Filter.....	H-5503	Oil Filter Full Flow.....	C-5510
Oil Filter Full Flow.....	0-5503	Hydraulic Oil Filter.....	H-5504		
		Oil Filter Full Flow.....	C-5510	D350D (ARTICULATED TRUCKS) w/3306 Eng.	
D346 (GENERATORS) S/N: 40J246-UP				Air Filter Primary.....	A-5535M
Air Filter.....	A-5518	D350D (ARTICULATED TRUCKS) CAT 3306 (S/N: 9RF1-UP) , 2005-UP		Air Filter Set.....	A-5573M-S
Fuel Filter.....	F-5501	Air Filter Primary.....	A-5501		
Oil Filter Full Flow.....	0-5502	Air Filter Secondary.....	A-5502	D350E (ARTICULATED TRUCKS) CAT 3406 (S/N: 2XW1-UP) , 2005-UP	
		Air Filter Secondary.....	A-5534	Air Filter Secondary.....	A-5534
D348 (GENERATORS) S/N: 36J1-560		Air Filter Primary.....	A-5535	Air Filter Primary.....	A-5535
Air Filter.....	A-5518	Air Filter Set.....	A-5573-S	Air Filter Set.....	A-5573-S
Fuel Filter.....	F-5501	Fuel Filter.....	F-5505	Air Filter.....	AH-7001
Oil Filter Full Flow.....	0-5503	Fuel Filter Secondary.....	FC-5507	Fuel Filter.....	FC-5509
		Hydraulic Oil Filter.....	H-5504	Fuel/Water Separator Secondary..	SFC-5504-10B
D348 (GENERATORS) S/N: 38J1-192		Hydraulic Oil Filter.....	H-5503	Fuel/Water Separator Secondary..	SFC-5504-10
Air Filter.....	A-5518	Oil Filter Full Flow.....	C-5510	Hydraulic Oil Filter.....	H-5504
Fuel Filter.....	F-5501			Hydraulic Oil Filter.....	H-5526
Oil Filter Full Flow.....	0-5503	D350D (ARTICULATED TRUCKS) S/N: 1HK1-673		Oil Filter Full Flow.....	C-5516
		Air Filter Set.....	A-5573-S		
D348 (GENERATORS) S/N: 38J193-UP		Air Filter Primary.....	A-5535	D350E (ARTICULATED TRUCKS) CAT 3406 (S/N: 9LR1-UP) , 2005-UP	
Air Filter.....	A-5518	Air Filter Secondary.....	A-5534	Air Filter Set.....	A-5573-S
Fuel Filter.....	F-5501	Air Filter Secondary.....	A-5502	Air Filter Primary.....	A-5535
Oil Filter Full Flow.....	0-5503	Air Filter Primary.....	A-5501	Air Filter Secondary.....	A-5534
		Fuel Filter Secondary.....	FC-5507	Fuel Filter.....	F-5505
D348 (GENERATORS) S/N: 38J193-UP		Fuel Filter.....	F-5505	Fuel Filter.....	FC-5509
Air Filter.....	A-5518	Hydraulic Oil Filter.....	H-55270	Hydraulic Oil Filter.....	H-5504
		Hydraulic Oil Filter.....	H-5526	Hydraulic Oil Filter.....	H-5503
		Hydraulic Oil Filter.....	H-55280	Oil Filter Full Flow.....	C-5516
		Hydraulic Oil Filter.....	H-5503		
		Hydraulic Oil Filter.....	H-5504		

MODEL/APPLICATION	SAKURA NO	MODEL/APPLICATION	SAKURA NO	MODEL/APPLICATION	SAKURA NO
CATERPILLAR		CATERPILLAR		CATERPILLAR	
D350E (ARTICULATED TRUCKS)		Air Filter Set.....	A-5573-S	D3B (DOZERS) S/N: 27Y1-UP	
Hydraulic Oil Filter Suction.....	H-5516	Fuel Filter.....	FC-5509	Air Filter Secondary.....	A-5525
D350E (ARTICULATED TRUCKS) S/N: 9LR1-UP		Fuel/Water Separator Secondary..	SFC-5504-10	Air Filter Primary.....	A-5542
Air Filter Secondary.....	A-5534	Fuel/Water Separator Secondary..	SFC-5504-10B	Air Filter Set.....	A-5542-S
Air Filter Primary.....	A-5535	Hydraulic Oil Filter.....	H-5504	Fuel Filter.....	FC-5503
Air Filter Set.....	A-5573-S	Hydraulic Oil Filter.....	H-5526	Hydraulic Oil Filter.....	H-5504
Fuel Filter.....	FC-5509	Hydraulic Oil Filter.....	H-55270	Oil Filter Full Flow.....	C-5519
Hydraulic Oil Filter.....	H-5526	D350E SERIES II (ARTICULATED TRUCKS) w/3406E Eng.		D3B (DOZERS) S/N: 28Y1-UP	
Hydraulic Oil Filter.....	H-5503	Air Filter Set.....	A-5573M-S	Air Filter Set.....	A-5542-S
Hydraulic Oil Filter.....	H-55270	Air Filter Primary.....	A-5535M	Air Filter Primary.....	A-5542
Hydraulic Oil Filter.....	H-55280	D35C HP (ARTICULATED TRUCKS) S/N: 3FD1-UP		Air Filter Secondary.....	A-5525
Hydraulic Oil Filter.....	H-5504	Air Filter Secondary.....	A-5502	Fuel Filter.....	FC-5503
Oil Filter Full Flow.....	C-5516	Air Filter Primary.....	A-5501	Hydraulic Oil Filter.....	H-5504
D350E (ARTICULATED TRUCKS) w/3406 Eng.		Fuel Filter.....	FC-5519	Oil Filter Full Flow.....	C-5519
Air Filter Primary.....	A-5535M	Hydraulic Oil Filter.....	H-5504	D3B (DOZERS) S/N: 29C1-245	
Air Filter Set.....	A-5573M-S	Hydraulic Oil Filter.....	H-5503	Air Filter Secondary.....	A-5522
D35C (ARTICULATED TRUCKS) CAT 3306 (S/N: 2GD1-124) , 2005-UP		Oil Filter Full Flow.....	C-5516	Air Filter Primary.....	A-5509
Air Filter Secondary.....	A-5502	D397D (GENERATORS) S/N: 321-321		Air Filter Set.....	A-5522-S
Air Filter Primary.....	A-5501	Oil Filter Full Flow.....	0-5503	Hydraulic Oil Filter.....	H-5501
Fuel Filter.....	F-5505	D397D (GENERATORS) S/N: 41B1-UP		D3B (DOZERS) S/N: 2PC1-UP	
Fuel Filter Secondary.....	FC-5507	Oil Filter Full Flow.....	0-5503	Air Filter Primary.....	A-5509
Hydraulic Oil Filter.....	H-5503	D3B (DOZERS) CAT (S/N: 45V32894-40546)		Air Filter Secondary.....	A-5522-S
Hydraulic Oil Filter.....	H-5504	Oil Filter Full Flow.....	C-5519	Fuel Filter Secondary.....	FC-5507
Oil Filter Full Flow.....	C-5510	D3B (DOZERS) CAT (S/N: 45V40547-72653)		Oil Filter Full Flow.....	C-5519
D35C (ARTICULATED TRUCKS) CAT 3306		Fuel Filter Secondary.....	FC-5507	Oil Filter Full Flow.....	C-5505
Air Filter Primary.....	A-44150	Oil Filter Full Flow.....	C-5505	D3B (DOZERS) S/N: 2PC246-UP	
Air Filter Set.....	A-44150-S	D3B (DOZERS) CAT (S/N: 45V72654-UP)		Air Filter Secondary.....	A-5522
D35C (ARTICULATED TRUCKS) S/N: 2GD1-124		Fuel Filter Secondary.....	FC-5507	Air Filter Primary.....	A-5509
Air Filter Secondary.....	A-5502	Fuel Filter.....	FC-5501	Air Filter Set.....	A-5522-S
Air Filter Primary.....	A-5501	Oil Filter Full Flow.....	C-5505	Hydraulic Oil Filter.....	H-5504
Fuel Filter Secondary.....	FC-5507	D3B (DOZERS) S/N: 23Y1-UP		Hydraulic Oil Filter.....	H-5501
Fuel Filter.....	F-5505	Air Filter Secondary.....	A-5525	Hydraulic Oil Filter.....	H-5504
Hydraulic Oil Filter.....	H-5504	Air Filter Primary.....	A-5542	D3B (DOZERS) S/N: 3YC1-UP	
Hydraulic Oil Filter.....	H-5503	Air Filter Set.....	A-5542-S	Hydraulic Oil Filter.....	H-5501
Hydraulic Oil Filter.....	H-55280	Fuel Filter.....	FC-5503	Hydraulic Oil Filter.....	H-5504
Hydraulic Oil Filter.....	H-55270	Hydraulic Oil Filter.....	H-5504	D3B (DOZERS) S/N: 5MC1-UP	
Hydraulic Oil Filter.....	H-5526	Oil Filter Full Flow.....	C-5519	Hydraulic Oil Filter.....	H-5501
Oil Filter Full Flow.....	C-5510	D3B (DOZERS) S/N: 24Y1-UP		Hydraulic Oil Filter.....	H-5504
D35 HP (ARTICULATED TRUCKS) CAT 3406 (S/N: 3FD1-79) , 2005-UP		Air Filter Set.....	A-5542-S	D3B (DOZERS) S/N: 3YC1-UP	
Air Filter Primary.....	A-5501	Air Filter Primary.....	A-5542	Air Filter Secondary.....	A-5590
Air Filter Secondary.....	A-5502	Air Filter Secondary.....	A-5525	Hydraulic Oil Filter.....	H-55320
Fuel Filter.....	F-5505	Fuel Filter.....	FC-5503	D3B LGP (DOZERS) S/N: 3YC1-UP	
Fuel Filter.....	FC-5509	Hydraulic Oil Filter.....	H-5504	Air Filter Secondary.....	A-5525
Hydraulic Oil Filter.....	H-5503	Oil Filter Full Flow.....	C-5519	Air Filter Set.....	A-5542-S
Hydraulic Oil Filter.....	H-5526	D350E SERIES II (ARTICULATED TRUCKS) CAT 3406E (S/N: 2XW1-UP)		Air Filter Primary.....	A-5542
Oil Filter Full Flow.....	C-5510	Air Filter Secondary.....	A-5534	Fuel Filter.....	FC-5503
D350E SERIES II (ARTICULATED TRUCKS) CAT 3406E (S/N: 2XW1-UP)		Air Filter Primary.....	A-5535	Fuel Filter Secondary.....	FC-5507
Air Filter Secondary.....	A-5534				
Air Filter Primary.....	A-5535				

MODEL/APPLICATION	SAKURA NO	MODEL/APPLICATION	SAKURA NO	MODEL/APPLICATION	SAKURA NO
CATERPILLAR		CATERPILLAR		CATERPILLAR	
D3B LGP (DOZERS) S/N: 3YC1-UP Hydraulic Oil Filter..... H-55270 Hydraulic Oil Filter..... H-5504 Oil Filter Full Flow..... C-5519		D3C (DOZERS) S/N: 4KS1-UP Air Filter Primary..... A-5542 Air Filter Secondary..... A-5525 Air Filter Set..... A-5542-S Hydraulic Oil Filter..... HC-5504 Oil Filter Full Flow..... C-5504		D3C (DOZERS) S/N: 6SL1-UP Air Filter Set..... A-5542-S Air Filter Secondary..... A-5525 Air Filter Primary..... A-5542 Hydraulic Oil Filter..... H-55270 Hydraulic Oil Filter..... H-5504 Oil Filter Full Flow..... C-5504	
D3B LGP (DOZERS) S/N: 5MC1-UP Air Filter Primary..... A-5542 Air Filter Set..... A-5542-S Air Filter Secondary..... A-5525 Fuel Filter Secondary..... FC-5507 Fuel Filter..... FC-5503 Hydraulic Oil Filter..... H-5504 Hydraulic Oil Filter..... H-55270 Oil Filter Full Flow..... C-5519		D3C (DOZERS) S/N: 4T51-UP Air Filter Set..... A-5542-S Air Filter Secondary..... A-5525 Air Filter Primary..... A-5542 Hydraulic Oil Filter..... HC-5504 Oil Filter Full Flow..... C-5504		D3C (DOZERS) S/N: 7JF1-UP Air Filter Secondary..... A-5522 Air Filter Set..... A-5522-S Air Filter Primary..... A-5509 Fuel Filter Secondary..... FC-5507 Hydraulic Oil Filter..... H-5504 Hydraulic Oil Filter..... H-55270 Oil Filter Full Flow..... C-5505	
D3C (DOZERS) CAT (S/N: 45V1-69305) Oil Filter Full Flow..... C-5505		D3C (DOZERS) S/N: 5CJ1-UP Air Filter Primary..... A-5542 Air Filter Secondary..... A-5525 Air Filter Set..... A-5542-S Fuel Filter Secondary..... FC-5507 Hydraulic Oil Filter..... H-55270 Hydraulic Oil Filter..... H-5504 Oil Filter Full Flow..... C-5519		D3C (DOZERS) S/N: 7JG1-UP Air Filter Set..... A-5542-S Air Filter Primary..... A-5542 Air Filter Secondary..... A-5525 Fuel Filter Secondary..... FC-5507 Hydraulic Oil Filter..... H-55270 Hydraulic Oil Filter..... H-5504 Oil Filter Full Flow..... C-5519	
D3C (DOZERS) CAT (S/N: 45V69306-70377) Fuel Filter..... FC-5501 Oil Filter Full Flow..... C-5519 Oil Filter Full Flow..... C-5505		D3C (DOZERS) S/N: 5GS1-UP Air Filter Set..... A-5542-S Air Filter Secondary..... A-5525 Air Filter Primary..... A-5542 Hydraulic Oil Filter..... HC-5504 Oil Filter Full Flow..... C-5504		D3C (DOZERS) S/N: 7XL1-UP Air Filter Secondary..... A-5525 Air Filter Primary..... A-5542 Air Filter Set..... A-5542-S Hydraulic Oil Filter..... H-5504 Hydraulic Oil Filter..... H-55270 Oil Filter Full Flow..... C-5504	
D3C (DOZERS) CAT (S/N: 45V70378-UP) Fuel Filter..... FC-5501 Fuel Filter Secondary..... FC-5507 Oil Filter Full Flow..... C-5519 Oil Filter Full Flow..... C-5505		D3C (DOZERS) S/N: 5KG1-UP Air Filter Primary..... A-5542 Air Filter Secondary..... A-5525 Air Filter Set..... A-5542-S Fuel Filter Secondary..... FC-5507 Hydraulic Oil Filter..... H-5504 Hydraulic Oil Filter..... H-55270 Oil Filter Full Flow..... C-5519		D3C (DOZERS) S/N: 7YJ1-UP Fuel Filter..... FC-5501 Fuel Filter Secondary..... FC-5507 Oil Filter Full Flow..... C-5519 Oil Filter Full Flow..... C-5505	
D3C (DOZERS) S/N: 1PJ1-UP Air Filter Set..... A-5542-S Air Filter Secondary..... A-5525 Air Filter Primary..... A-5542 Fuel Filter Secondary..... FC-5507 Hydraulic Oil Filter..... H-5504 Hydraulic Oil Filter..... H-55270 Oil Filter Full Flow..... C-5519		D3C (DOZERS) S/N: 5ZG1-UP Air Filter Set..... A-5542-S Air Filter Secondary..... A-5525 Air Filter Primary..... A-5542 Fuel Filter Secondary..... FC-5507 Hydraulic Oil Filter..... H-55270 Hydraulic Oil Filter..... H-5504 Oil Filter Full Flow..... C-5519		D3C (DOZERS) S/N: 8BF1-UP Air Filter Set..... A-5542-S Air Filter Primary..... A-5542 Air Filter Secondary..... A-5525 Fuel Filter Secondary..... FC-5507 Hydraulic Oil Filter..... H-55270 Hydraulic Oil Filter..... H-5504 Oil Filter Full Flow..... C-5519	
D3C (DOZERS) S/N: 3RF1-UP Air Filter Primary..... A-5542 Air Filter Secondary..... A-5525 Air Filter Set..... A-5542-S Fuel Filter Secondary..... FC-5507 Hydraulic Oil Filter..... H-55270 Hydraulic Oil Filter..... H-5504 Oil Filter Full Flow..... C-5519		D3C (DOZERS) S/N: 6PF1-UP Air Filter Primary..... A-5542 Air Filter Secondary..... A-5525 Air Filter Set..... A-5542-S Fuel Filter Secondary..... FC-5507 Hydraulic Oil Filter..... H-5504 Hydraulic Oil Filter..... H-55270 Oil Filter Full Flow..... C-5519		D3C (DOZERS) S/N: 8DG1-UP Air Filter Secondary..... A-5525 Air Filter Primary..... A-5542 Air Filter Set..... A-5542-S Fuel Filter Secondary..... FC-5507 Hydraulic Oil Filter..... H-5504 Hydraulic Oil Filter..... H-55270 Oil Filter Full Flow..... C-5519	
D3C (DOZERS) S/N: 4HJ1-UP Air Filter Set..... A-5542-S Air Filter Secondary..... A-5525 Air Filter Primary..... A-5542 Fuel Filter Secondary..... FC-5507 Hydraulic Oil Filter..... H-5504 Hydraulic Oil Filter..... H-55270 Oil Filter Full Flow..... C-5519		D3C (DOZERS) S/N: 6PF1-UP Air Filter Primary..... A-5542 Air Filter Secondary..... A-5525 Air Filter Set..... A-5542-S Fuel Filter Secondary..... FC-5507 Hydraulic Oil Filter..... H-5504 Hydraulic Oil Filter..... H-55270 Oil Filter Full Flow..... C-5519		D3C (DOZERS) S/N: 8DG1-UP Air Filter Secondary..... A-5525 Air Filter Primary..... A-5542 Air Filter Set..... A-5542-S Fuel Filter Secondary..... FC-5507 Hydraulic Oil Filter..... H-5504 Hydraulic Oil Filter..... H-55270 Oil Filter Full Flow..... C-5519	

Sakura Filter

ENGINE APPLICATION

MODEL/APPLICATION	SAKURA NO	MODEL/APPLICATION	SAKURA NO	MODEL/APPLICATION	SAKURA NO
CATERPILLAR		CATERPILLAR		CATERPILLAR	
D3C (DOZERS) S/N: 9CL1-UP		D3C LGP XL SERIES III (DOZERS) S/N: 5G51-UP		Fuel Filter.....	FC-1010
Oil Filter Full Flow.....	C-5519	Air Filter Secondary.....	A-5525	Fuel Filter.....	FC-5516
D3C (DOZERS) S/N: 9TS1-UP		Air Filter Primary.....	A-5542	Fuel Filter Secondary.....	FC-5515
Air Filter Set.....	A-5542-S	Air Filter Set.....	A-5542-S	Fuel Filter Secondary.....	FC-55151
Air Filter Primary.....	A-5542	Hydraulic Oil Filter.....	HC-5504	Oil Filter Full Flow.....	C-5504
Air Filter Secondary.....	A-5525	Oil Filter Full Flow.....	C-5504	D3C SERIES III (DOZERS) S/N: 4KS1-394	
Oil Filter Full Flow.....	C-5504	D3C LGP XL SERIES III (DOZERS) S/N: 6SL1-UP		Air Filter Secondary.....	A-5525
D3C (DOZERS) w/3046 Eng.		Air Filter Set.....	A-5542-S	Air Filter Primary.....	A-5542
Air Filter Secondary.....	A-5590	Air Filter Primary.....	A-5542	Air Filter Set.....	A-5542-S
D3C (DOZERS) w/3204 Eng.		Air Filter Secondary.....	A-5525	Cabin Air Filter.....	CA-55070
Air Filter Secondary.....	A-5590	Hydraulic Oil Filter.....	H-5504	Hydraulic Oil Filter.....	HC-5504
D3C (DOZERS) w/3204 Eng.		Hydraulic Oil Filter.....	H-55270	D3C SERIES III (DOZERS) S/N: 4KS395-UP	
Hydraulic Oil Filter.....	H-55320	Oil Filter Full Flow.....	C-5504	Air Filter Set.....	A-5542-S
D3C LGP (DOZERS) S/N: 1PJ1-UP		D3C LGP XL SERIES III (DOZERS) S/N: 7XL1-UP		Air Filter Primary.....	A-5542
Air Filter Secondary.....	A-5525	Air Filter Secondary.....	A-5525	Air Filter Secondary.....	A-5525
Air Filter Set.....	A-5542-S	Air Filter Primary.....	A-5542	Cabin Air Filter.....	CA-55070
Air Filter Primary.....	A-5542	Air Filter Set.....	A-5542-S	Hydraulic Oil Filter.....	HC-5504
Fuel Filter Secondary.....	FC-5507	Hydraulic Oil Filter.....	H-55270	D3C SERIES III (DOZERS) S/N: 5G51-373	
Hydraulic Oil Filter.....	H-55270	Hydraulic Oil Filter.....	H-5504	Air Filter Secondary.....	A-5525
Hydraulic Oil Filter.....	H-5504	Oil Filter Full Flow.....	C-5504	Air Filter Primary.....	A-5542
Oil Filter Full Flow.....	C-5519	D3C LGP XL SERIES III (DOZERS) S/N: 9TS1-UP		Air Filter Set.....	A-5542-S
D3C LGP (DOZERS) S/N: 5KG1-UP		Air Filter Set.....	A-5542-S	Cabin Air Filter.....	CA-55070
Air Filter Set.....	A-5542-S	Air Filter Primary.....	A-5542	Hydraulic Oil Filter.....	HC-5504
Air Filter Secondary.....	A-5525	Air Filter Secondary.....	A-5525	D3C SERIES III (DOZERS) S/N: 5G5374-UP	
Air Filter Primary.....	A-5542	Oil Filter Full Flow.....	C-5504	Air Filter Primary.....	A-5542
Fuel Filter Secondary.....	FC-5507	D3C SERIES II (DOZERS) CAT (S/N: 45V90750-UP)		Air Filter Secondary.....	A-5525
Hydraulic Oil Filter.....	H-55270	Fuel Filter.....	FC-5501	Air Filter Set.....	A-5542-S
Hydraulic Oil Filter.....	H-5504	Oil Filter Full Flow.....	C-5519	Cabin Air Filter.....	CA-55070
Oil Filter Full Flow.....	C-5519	D3C SERIES III (DOZERS) S/N: 7YJ1-2721		Hydraulic Oil Filter.....	HC-5504
D3C LGP (DOZERS) S/N: 8BF1-UP		Fuel Filter.....	FC-5501	D3C SERIES III (DOZERS) S/N: 6SL2556-UP	
Air Filter Secondary.....	A-5525	Fuel Filter Secondary.....	FC-5507	Air Filter Primary.....	A-5542
Air Filter Set.....	A-5542-S	Oil Filter Full Flow.....	C-5519	Air Filter Secondary.....	A-5525
Air Filter Primary.....	A-5542	Oil Filter Full Flow.....	C-5505	Air Filter Set.....	A-5542-S
Fuel Filter Secondary.....	FC-5507	Oil Filter Full Flow.....	C-5519	Cabin Air Filter.....	CA-55070
Hydraulic Oil Filter.....	H-55270	D3C SERIES II (DOZERS) CAT (S/N: 7YJ2722-UP)		Hydraulic Oil Filter.....	H-55270
Hydraulic Oil Filter.....	H-5504	Fuel Filter Secondary.....	FC-5507	Hydraulic Oil Filter.....	H-5501
Oil Filter Full Flow.....	C-5519	Fuel Filter.....	FC-5501	D3C SERIES III (DOZERS) S/N: 7XL1108-UP	
D3C LGP XL SERIES III (DOZERS) S/N: 4KS1-UP		Oil Filter Full Flow.....	C-5505	Air Filter Primary.....	A-5542
Air Filter Secondary.....	A-5525	Oil Filter Full Flow.....	C-5519	Air Filter Secondary.....	A-5525
Air Filter Primary.....	A-5542	D3C SERIES II (DOZERS) S/N: 8DG1-UP		Air Filter Set.....	A-5542-S
Air Filter Set.....	A-5542-S	Air Filter Secondary.....	A-5525	Cabin Air Filter.....	CA-55070
Hydraulic Oil Filter.....	HC-5504	Air Filter Set.....	A-5542-S	Hydraulic Oil Filter.....	H-5501
Oil Filter Full Flow.....	C-5504	Air Filter Primary.....	A-5542	Hydraulic Oil Filter.....	H-55270
D3C LGP XL SERIES III (DOZERS) S/N: 4TS1-UP		Hydraulic Oil Filter.....	H-55270	D3C SERIES III (DOZERS) S/N: 7XL1108-UP	
Air Filter Set.....	A-5542-S	Hydraulic Oil Filter.....	H-5504	Air Filter Secondary.....	A-5525
Air Filter Primary.....	A-5542	D3C SERIES II (DOZERS) w/3204 Eng.		Air Filter Primary.....	A-5542
Air Filter Secondary.....	A-5525	Hydraulic Oil Filter.....	H-55320	Air Filter Set.....	A-5542-S
Hydraulic Oil Filter.....	HC-5504	D3C SERIES III (DOZERS) CAT (S/N: 5XK1-UP)		Cabin Air Filter.....	CA-55070
Oil Filter Full Flow.....	C-5504	Fuel Filter.....	FC-5501	Hydraulic Oil Filter.....	H-55270
		Oil Filter Full Flow.....	C-5519	Hydraulic Oil Filter.....	H-5501

MODEL/APPLICATION	SAKURA NO	MODEL/APPLICATION	SAKURA NO	MODEL/APPLICATION	SAKURA NO
CATERPILLAR		CATERPILLAR		CATERPILLAR	
D3C SERIES III (DOZERS) S/N: 7XL1-1107 Air Filter Primary..... A-5542 Air Filter Secondary..... A-5525 Air Filter Set..... A-5542-S Cabin Air Filter..... CA-55070 Hydraulic Oil Filter..... H-5501 Hydraulic Oil Filter..... H-55270		D3K (DOZERS) CAT S/N: FFF1-UP , 2007-UP Oil Filter Full Flow..... C-5102 D3K (DOZERS) CAT S/N: LLL1-UP , 2007-UP Hydraulic Oil Filter..... HC-5504 Oil Filter Full Flow..... C-5102 D400 (ARTICULATED TRUCKS) CAT 3406B (S/N: 1MD1-246) , 2005-UP Air Filter Primary..... A-5501 Air Filter Secondary..... A-5502 Fuel Filter..... FC-5509 Fuel Filter..... F-5505 Hydraulic Oil Filter..... H-5503 Hydraulic Oil Filter..... H-5504 Oil Filter Full Flow..... C-5516 D400 (ARTICULATED TRUCKS) CAT 3406 (S/N: 1MD-UP) Air Filter Primary..... A-5501 Air Filter Secondary..... A-5502 Air Filter Secondary..... A-5534 Air Filter Primary..... A-5535 Air Filter Set..... A-5573-S Fuel Filter..... FC-5502 Fuel Filter..... FC-5509 Hydraulic Oil Filter..... H-55270 Hydraulic Oil Filter..... H-5504 Hydraulic Oil Filter..... H-5503 D400 (ARTICULATED TRUCKS) CAT 3406 (S/N: 2JJ-UP) Air Filter Set..... A-5573-S Air Filter Primary..... A-5535 Air Filter Secondary..... A-5534 Air Filter Secondary..... A-5502 Air Filter Primary..... A-5501 Fuel Filter..... FC-5509 Fuel Filter..... FC-5502 Hydraulic Oil Filter..... H-5503 Hydraulic Oil Filter..... H-5504 Hydraulic Oil Filter..... H-55270 D400 (ARTICULATED TRUCKS) CAT 3406 (S/N: 2YR1-UP) Air Filter Primary..... A-5501 Air Filter Secondary..... A-5502 Air Filter Secondary..... A-5534 Air Filter Primary..... A-5535 Air Filter Set..... A-5573-S Fuel Filter..... FC-5502 Fuel Filter..... FC-5509 Hydraulic Oil Filter..... H-55270 Hydraulic Oil Filter..... H-5504 Hydraulic Oil Filter..... H-5503 D400 (ARTICULATED TRUCKS) CAT 3406 (S/N: 8TF1-UP) Air Filter Set..... A-5573-S Air Filter Primary..... A-5535 Air Filter Secondary..... A-5534 Air Filter Secondary..... A-5502 Air Filter Primary..... A-5501 Fuel Filter..... FC-5509 Fuel Filter..... FC-5502 Hydraulic Oil Filter..... H-5503 Hydraulic Oil Filter..... H-5504 Hydraulic Oil Filter..... H-55270 D400 (ARTICULATED TRUCKS) CAT 3406 (S/N: 8PS1-UP) Air Filter Set..... A-5573-S Air Filter Primary..... A-5535 Air Filter Secondary..... A-5534 Air Filter Secondary..... A-5502		Air Filter Primary..... A-5501 Fuel Filter..... FC-5509 Fuel Filter..... FC-5502 Hydraulic Oil Filter..... H-5503 Hydraulic Oil Filter..... H-5504 Hydraulic Oil Filter..... H-55270 D400 (ARTICULATED TRUCKS) CAT 3406TA Air Filter Set..... A-44150-S Air Filter Primary..... A-44150 D400 (ARTICULATED TRUCKS) S/N: 1MD1-246 Air Filter Primary..... A-5501 Air Filter Secondary..... A-5502 Fuel Filter..... FC-5509 Hydraulic Oil Filter..... H-5503 Hydraulic Oil Filter..... H-55270 Hydraulic Oil Filter..... H-5526 Hydraulic Oil Filter..... H-55280 Hydraulic Oil Filter..... H-5504 Oil Filter Full Flow..... C-5516 D400D (ARTICULATED TRUCKS) CAT 3406 (S/N: 8TF1-UP) , 2005-UP Air Filter Primary..... A-5501 Air Filter Secondary..... A-5502 Coolant Filter..... WC-6901 Fuel Filter..... FC-5509 Hydraulic Oil Filter..... H-5503 Hydraulic Oil Filter..... H-5504 Oil Filter Full Flow..... C-5516 D400D (ARTICULATED TRUCKS) S/N: 8TF1-UP Air Filter Primary..... A-5501 Air Filter Primary..... A-5535 Air Filter Set..... A-5573-S Air Filter Secondary..... A-5534 Fuel Filter..... FC-5509 Fuel Filter..... FC-5519 Hydraulic Oil Filter..... H-5503 Hydraulic Oil Filter..... H-5504 Oil Filter Full Flow..... C-5516 D400E (ARTICULATED TRUCKS) CAT 3406 (S/N: 2YR1-UP) , 2005-UP Air Filter Secondary..... A-5534 Air Filter Primary..... A-5535 Air Filter Set..... A-5573-S Fuel Filter..... F-5505 Fuel Filter..... FC-5509 Hydraulic Oil Filter..... H-5504 Hydraulic Oil Filter..... H-5503 Oil Filter Full Flow..... C-5516 D400E (ARTICULATED TRUCKS) CAT 3406 (S/N: 8PS1-UP) , 2005-UP Air Filter..... AH-7001 Air Filter Secondary..... A-44230 Air Filter Set..... A-44240-S Air Filter Primary..... A-44220 Fuel Filter..... FC-5509 Fuel/Water Separator Secondary.. SFC-5504-10B	
D3G (DOZERS) CAT (S/N: 5XK1-UP) Fuel Filter Secondary..... FC-55151 Fuel Filter Secondary..... FC-5515 Fuel Filter..... FC-5516 Fuel Filter..... FC-1010 Oil Filter Full Flow..... C-5504 D3G (DOZERS) CAT (S/N: MHK1-UP) Fuel Filter..... FC-5516 Fuel Filter Secondary..... FC-5515 Fuel Filter Secondary..... FC-55151 Oil Filter Full Flow..... C-5504 D3G (DOZERS) CAT 3046 Air Filter Secondary..... A-4402 Oil Filter Full Flow..... C-6218 D3G (DOZERS) S/N: BYR1-UP Hydraulic Oil Filter..... HC-5504 Hydraulic Oil Filter..... HC-5507 D3G (DOZERS) S/N: CFC1-UP Hydraulic Oil Filter..... HC-5507 Hydraulic Oil Filter..... HC-55220 Hydraulic Oil Filter..... HC-5504 D3G (DOZERS) S/N: CFF1-UP Hydraulic Oil Filter..... HC-5504 Hydraulic Oil Filter..... HC-55220 Hydraulic Oil Filter..... HC-5507 D3G (DOZERS) S/N: JMH1-UP Hydraulic Oil Filter..... HC-5507 Hydraulic Oil Filter..... HC-5504 D3 G LGP (DOZERS) CAT 3046 T Air Filter Secondary..... A-4402 Oil Filter Full Flow..... C-6218 D3K (DOZERS) CAT S/N: C4E1-49-UP , 2007-UP Hydraulic Oil Filter..... HC-5504 Oil Filter Full Flow..... C-5102 D3K (DOZERS) CAT S/N: C4E50-UP , 2007-UP Hydraulic Oil Filter..... HC-5504 Oil Filter Full Flow..... C-5102					

MODEL/APPLICATION	SAKURA NO
CATERPILLAR	
D400E (ARTICULATED TRUCKS) CAT 3406 (S/N: 8PS1-UP) , 2005-UP	
Fuel/Water Separator Secondary..	SFC-5504-10
Hydraulic Oil Filter.....	H-5504
Hydraulic Oil Filter.....	H-5526
Oil Filter Full Flow.....	C-5516
D400E (ARTICULATED TRUCKS) CAT 3406 (S/N: APF00274-UP) , 2005-UP	
Air Filter Primary.....	A-44220
Air Filter Set.....	A-44240-S
Air Filter Secondary.....	A-44230
Air Filter.....	AH-7001
Fuel Filter.....	FC-5509
Fuel/Water Separator Secondary..	SFC-5504-10B
Fuel/Water Separator Secondary..	SFC-5504-10
Hydraulic Oil Filter.....	H-5526
Hydraulic Oil Filter.....	H-5504
Oil Filter Full Flow.....	C-5516
D400E (ARTICULATED TRUCKS) CAT 3406E (S/N: APF-UP)	
Air Filter Secondary.....	A-44230
Air Filter Primary.....	A-44220
Air Filter Set.....	A-44240-S
Fuel Filter.....	FC-5509
Fuel/Water Separator Secondary..	SFC-5504-10B
Fuel/Water Separator Secondary..	SFC-5504-10
Hydraulic Oil Filter.....	H-55270
Hydraulic Oil Filter.....	H-5504
Oil Filter Full Flow.....	C-5516
D400E (ARTICULATED TRUCKS) S/N: 2YR1-UP	
Air Filter Set.....	A-5573-S
Air Filter Secondary.....	A-5534
Air Filter Primary.....	A-5535
Fuel Filter.....	FC-5509
Hydraulic Oil Filter.....	H-5504
Hydraulic Oil Filter.....	H-55270
Hydraulic Oil Filter.....	H-5503
Hydraulic Oil Filter.....	H-55280
Hydraulic Oil Filter.....	H-5526
Oil Filter Full Flow.....	C-5516
D400E (ARTICULATED TRUCKS) w/3406 Eng.	
Air Filter Set.....	A-5573M-S
Air Filter Primary.....	A-5535M
D400E II (ARTICULATED TRUCKS) CAT 3406B (S/N: 8PS1-UP) , 2005-UP	
Air Filter Set.....	A-44240-S
Air Filter Secondary.....	A-44230
Air Filter Primary.....	A-44220
Fuel Filter.....	FC-5509
Fuel/Water Separator Secondary..	SFC-5504-10
Fuel/Water Separator Secondary..	SFC-5504-10B
Hydraulic Oil Filter.....	H-5526
Hydraulic Oil Filter.....	H-5504
Oil Filter Full Flow.....	C-5516
D40D (ARTICULATED TRUCKS) CAT 3406 (S/N: 2JJ-UP)	
Air Filter Primary.....	A-5521
Air Filter Set.....	A-5521-S
Fuel Filter.....	FC-5502
Fuel Filter.....	FC-5509
Fuel Filter.....	F-5505
Hydraulic Oil Filter.....	H-5503
Hydraulic Oil Filter.....	H-5504
D4 (DOZERS) S/N: 6U1-UP	
Oil Filter Full Flow.....	O-5501
D4 (DOZERS) S/N: 7U1-UP	
Oil Filter Full Flow.....	O-5501
D4 (DOZERS) S/N: 82J1-3259	
Air Filter Set.....	A-55071-S
Air Filter Secondary.....	A-5508
Air Filter Primary.....	A-5507
Air Filter Set.....	A-5507-S
Air Filter Secondary.....	A-5567

MODEL/APPLICATION	SAKURA NO
CATERPILLAR	
Air Filter Secondary.....	A-5502
Air Filter Primary.....	A-5501
Fuel Filter.....	F-5505
Fuel Filter.....	FC-5509
Hydraulic Oil Filter.....	H-5503
Hydraulic Oil Filter.....	H-5504
Oil Filter Full Flow.....	C-5516
D40D (ARTICULATED TRUCKS) CAT 3406 (S/N: 8TF1-UP) , 2005-UP	
Air Filter Primary.....	A-5501
Air Filter Secondary.....	A-5502
Fuel Filter.....	FC-5509
Fuel Filter.....	F-5505
Hydraulic Oil Filter.....	H-5503
Hydraulic Oil Filter.....	H-5504
Oil Filter Full Flow.....	C-5516
D40D (ARTICULATED TRUCKS) S/N: 1TF-UP	
Air Filter Set.....	A-5521-S
Air Filter Primary.....	A-5521
Fuel Filter.....	F-5505
Fuel Filter.....	FC-5509
Fuel Filter.....	FC-5502
Hydraulic Oil Filter.....	H-5504
Hydraulic Oil Filter.....	H-5503
D40D (ARTICULATED TRUCKS) S/N: 2JJ-UP	
Air Filter Primary.....	A-5521
Air Filter Set.....	A-5521-S
Fuel Filter.....	FC-5502
Fuel Filter.....	FC-5509
Fuel Filter.....	F-5505
Hydraulic Oil Filter.....	H-5503
Hydraulic Oil Filter.....	H-5504
D4 (DOZERS) Excluding S/N: 82J3256	
Air Filter Set.....	A-5507-S
Air Filter Primary.....	A-5507
Air Filter Secondary.....	A-5508
Air Filter Set.....	A-55071-S
Air Filter Secondary.....	A-5567
Air Filter Set.....	A-5568-S
Air Filter Primary.....	A-5566
Hydraulic Oil Filter.....	H-5504
Oil Filter Full Flow.....	O-5502
D4 (DOZERS) S/N: 82J3256-UP	
Air Filter Set.....	A-55071-S
Air Filter Secondary.....	A-5508
Air Filter Primary.....	A-5507
Air Filter Set.....	A-5507-S
Air Filter Secondary.....	A-5567
Air Filter Primary.....	A-5566
Air Filter Set.....	A-5568-S
Hydraulic Oil Filter.....	H-5504
Oil Filter Full Flow.....	C-5510
D4 (DOZERS) S/N: 82J3260-UP	
Air Filter Set.....	A-5568-S
Air Filter Primary.....	A-5566
Air Filter Secondary.....	A-5567
Air Filter Set.....	A-5507-S
Air Filter Primary.....	A-5507
Air Filter Secondary.....	A-5508
Air Filter Set.....	A-55071-S
Hydraulic Oil Filter.....	H-5504
Oil Filter Full Flow.....	C-5510
D4 (DOZERS) S/N: 83J1-1810	
Air Filter Secondary.....	A-5567
Air Filter Primary.....	A-5566
Air Filter Set.....	A-5568-S
Air Filter Set.....	A-55071-S
Air Filter Secondary.....	A-5508
Air Filter Primary.....	A-5507
Air Filter Set.....	A-5507-S
Hydraulic Oil Filter.....	H-5504
Oil Filter Full Flow.....	O-5502
D4 (DOZERS) S/N: 84J1-1389	
Air Filter Set.....	A-5507-S
Air Filter Primary.....	A-5507
Air Filter Secondary.....	A-5508
Air Filter Set.....	A-55071-S
Air Filter Set.....	A-5568-S
Air Filter Primary.....	A-5566
Air Filter Secondary.....	A-5567
Hydraulic Oil Filter.....	H-5504
Oil Filter Full Flow.....	O-5502

MODEL/APPLICATION	SAKURA NO
CATERPILLAR	
Air Filter Primary.....	A-5566
Air Filter Set.....	A-5568-S
Hydraulic Oil Filter.....	H-5504
Oil Filter Full Flow.....	O-5502
D4 (DOZERS) S/N: 82J1811-UP	
Air Filter Set.....	A-5568-S
Air Filter Primary.....	A-5566
Air Filter Secondary.....	A-5567
Air Filter Set.....	A-5507-S
Air Filter Primary.....	A-5507
Air Filter Secondary.....	A-5508
Air Filter Set.....	A-55071-S
Hydraulic Oil Filter.....	H-5504
Oil Filter Full Flow.....	C-5510
D4 (DOZERS) S/N: 82J3256-UP	
Air Filter Set.....	A-55071-S
Air Filter Secondary.....	A-5508
Air Filter Primary.....	A-5507
Air Filter Set.....	A-5507-S
Air Filter Secondary.....	A-5567
Air Filter Primary.....	A-5566
Air Filter Set.....	A-5568-S
Hydraulic Oil Filter.....	H-5504
Oil Filter Full Flow.....	C-5510
D4 (DOZERS) S/N: 82J3260-UP	
Air Filter Set.....	A-5568-S
Air Filter Primary.....	A-5566
Air Filter Secondary.....	A-5567
Air Filter Set.....	A-5507-S
Air Filter Primary.....	A-5507
Air Filter Secondary.....	A-5508
Air Filter Set.....	A-55071-S
Hydraulic Oil Filter.....	H-5504
Oil Filter Full Flow.....	C-5510
D4 (DOZERS) S/N: 83J1-1810	
Air Filter Secondary.....	A-5567
Air Filter Primary.....	A-5566
Air Filter Set.....	A-5568-S
Air Filter Set.....	A-55071-S
Air Filter Secondary.....	A-5508
Air Filter Primary.....	A-5507
Air Filter Set.....	A-5507-S
Hydraulic Oil Filter.....	H-5504
Oil Filter Full Flow.....	O-5502
D4 (DOZERS) S/N: 84J1-1389	
Air Filter Set.....	A-5507-S
Air Filter Primary.....	A-5507
Air Filter Secondary.....	A-5508
Air Filter Set.....	A-55071-S
Air Filter Set.....	A-5568-S
Air Filter Primary.....	A-5566
Air Filter Secondary.....	A-5567
Hydraulic Oil Filter.....	H-5504
Oil Filter Full Flow.....	O-5502

MODEL/APPLICATION	SAKURA NO	MODEL/APPLICATION	SAKURA NO	MODEL/APPLICATION	SAKURA NO
CATERPILLAR		CATERPILLAR		CATERPILLAR	
D4 (DOZERS) S/N: 84J1390-UP Air Filter Primary..... A-5566 Air Filter Set..... A-5568-S Air Filter Set..... A-55071-S Air Filter Secondary..... A-5508 Air Filter Primary..... A-5507 Air Filter Set..... A-5507-S Air Filter Secondary..... A-5567 Hydraulic Oil Filter..... H-5504 Oil Filter Full Flow..... C-5510		Air Filter Secondary..... A-5529 Fuel Filter..... F-5505 Hydraulic Oil Filter..... H-5504 Hydraulic Oil Filter..... H-5503 Oil Filter Full Flow..... C-5516 D44B (ARTICULATED TRUCKS) S/N: 8SD1-UP Air Filter Secondary..... A-5529 Air Filter Primary..... A-5521 Air Filter Set..... A-5521-S Hydraulic Oil Filter..... H-5504 Hydraulic Oil Filter..... H-5526 Hydraulic Oil Filter..... H-55270 Hydraulic Oil Filter..... H-55280 Hydraulic Oil Filter..... H-5503 Oil Filter Full Flow..... C-5516 D4B (DOZERS) Air Filter Secondary..... A-5590 Hydraulic Oil Filter..... H-55320 D4B (DOZERS) S/N: 15G1-UP Air Filter Set..... A-5542-S Air Filter Primary..... A-5542 Air Filter Secondary..... A-5525 Fuel Filter..... FC-5503 Hydraulic Oil Filter..... H-55270 Hydraulic Oil Filter..... H-5504 Oil Filter Full Flow..... C-5519 D4B (DOZERS) S/N: 2XF1-UP Air Filter Secondary..... A-5525 Air Filter Primary..... A-5542 Air Filter Set..... A-5542-S Fuel Filter..... FC-5503 Hydraulic Oil Filter..... H-5504 Hydraulic Oil Filter..... H-55270 Oil Filter Full Flow..... C-5519 D4C (DOZERS) CAT (S/N: 45V69350-84090) Fuel Filter..... FC-5501 Oil Filter Full Flow..... C-5519 D4C (DOZERS) CAT (S/N: 45V84091-UP) Fuel Filter..... FC-5501 Oil Filter Full Flow..... C-5519 D4C (DOZERS) S/N: 1FW1-UP Air Filter Set..... A-5542-S Air Filter Secondary..... A-5525 Air Filter Primary..... A-5542 Fuel Filter..... FC-5509 Hydraulic Oil Filter..... H-5504 Hydraulic Oil Filter..... H-55270 Oil Filter Full Flow..... C-5504 D4C (DOZERS) S/N: 24A1-UP Oil Filter Full Flow..... C-5519		D4C (DOZERS) S/N: 39A1-UP Air Filter Primary..... A-5511 Air Filter Secondary..... A-5512 Air Filter Set..... A-5511-S Fuel Filter..... F-5501 Oil Filter Full Flow..... C-5519 D4C (DOZERS) S/N: 40A1-UP Air Filter Set..... A-5511-S Air Filter Secondary..... A-5512 Air Filter Primary..... A-5511 Fuel Filter..... F-5501 Oil Filter Full Flow..... C-5519 D4C (DOZERS) S/N: 4LS1-UP Air Filter Primary..... A-5542 Air Filter Secondary..... A-5525 Air Filter Set..... A-5542-S Hydraulic Oil Filter..... HC-5504 Oil Filter Full Flow..... C-5504 D4C (DOZERS) S/N: 54A1-UP Oil Filter Full Flow..... C-5519 D4C (DOZERS) S/N: 55A1-UP Oil Filter Full Flow..... C-5519 D4C (DOZERS) S/N: 69A1-UP Oil Filter Full Flow..... C-5519 D4C (DOZERS) S/N: 6BS1-UP Air Filter Set..... A-5542-S Air Filter Primary..... A-5542 Air Filter Secondary..... A-5525 Hydraulic Oil Filter..... HC-5504 Oil Filter Full Flow..... C-5504 D4C (DOZERS) S/N: 6YL1-UP Air Filter Secondary..... A-5525 Air Filter Primary..... A-5542 Air Filter Set..... A-5542-S Hydraulic Oil Filter..... H-5504 Hydraulic Oil Filter..... H-55270 Oil Filter Full Flow..... C-5504 D4C (DOZERS) S/N: 7SL1-UP Air Filter Secondary..... A-5525 Air Filter Set..... A-5542-S Air Filter Primary..... A-5542 Hydraulic Oil Filter..... H-5504 Oil Filter Full Flow..... C-5519 D4C (DOZERS) S/N: 8CS1-UP Air Filter Secondary..... A-5525 Air Filter Primary..... A-5542 Air Filter Set..... A-5542-S	
D400 SERIES II (ARTICULATED TRUCKS) S/N: 2YR-UP Air Filter Secondary..... A-5534 Air Filter Primary..... A-5535 Air Filter Set..... A-5573-S Fuel Filter..... FC-5509 Fuel Filter..... FC-5519 Hydraulic Oil Filter..... H-5504 Hydraulic Oil Filter..... H-5503 Hydraulic Oil Filter..... H-55270		D400 SERIES II (ARTICULATED TRUCKS) S/N: 8PS-UP Air Filter Set..... A-5573-S Air Filter Primary..... A-5535 Air Filter Secondary..... A-5534 Fuel Filter..... FC-5519 Fuel Filter..... FC-5509 Hydraulic Oil Filter..... H-55270 Hydraulic Oil Filter..... H-5503 Hydraulic Oil Filter..... H-5504		D400E SERIES II (ARTICULATED TRUCKS) CAT 3406E (S/N: 8PS1-UP) Air Filter Set..... A-44240-S Air Filter Primary..... A-44220 Air Filter Secondary..... A-44230 Fuel Filter..... FC-5509 Fuel/Water Separator Secondary.. SFC-5504-10B Fuel/Water Separator Secondary.. SFC-5504-10 Hydraulic Oil Filter..... H-55270 Hydraulic Oil Filter..... H-5526 Hydraulic Oil Filter..... H-5504 Oil Filter Full Flow..... C-5516	
D44 (ARTICULATED TRUCKS) S/N: 2LD1-UP Air Filter Secondary..... A-5529 Air Filter Primary..... A-5521 Air Filter Set..... A-5521-S Air Filter Primary..... A-5555 Air Filter Set..... A-5555-S Air Filter Secondary..... A-5556 Fuel Filter..... FC-5519 Hydraulic Oil Filter..... H-5503 Oil Filter Full Flow..... C-5516		D44B (ARTICULATED TRUCKS) CAT 3408 (S/N: 8SD1-UP) , 2005-UP Air Filter Set..... A-5521-S Air Filter Primary..... A-5521			

MODEL/APPLICATION	SAKURA NO	MODEL/APPLICATION	SAKURA NO	MODEL/APPLICATION	SAKURA NO
CATERPILLAR		CATERPILLAR		CATERPILLAR	
D4D (DOZERS) S/N: 83J1-1810		Oil Filter Full Flow.....	C-5522	Fuel Filter Secondary.....	FC-5507
Air Filter Set.....	A-55071-S	D4E (DOZERS) CAT (S/N: 12Z11158-UP)		Oil Filter Full Flow.....	C-5522
Air Filter Secondary.....	A-5508	Air Filter Secondary.....	A-5522	Oil Filter Full Flow.....	C-5510
Air Filter Set.....	A-5507-S	Air Filter Primary.....	A-5509	D4E (DOZERS) CAT S/N: 78P34523-46310	
Air Filter Primary.....	A-5507	Air Filter Set.....	A-5522-S	Fuel Filter Secondary.....	FC-5507
Air Filter Primary.....	A-5566	Fuel Filter Secondary.....	FC-5507	D4E (DOZERS) CAT S/N: 9CB683-UP	
Air Filter Set.....	A-5568-S	Oil Filter Full Flow.....	C-5522	Fuel Filter Secondary.....	FC-5507
Air Filter Secondary.....	A-5567	D4E (DOZERS) CAT (S/N: 46V1-9499)		Oil Filter Full Flow.....	C-5522
Fuel Filter Secondary.....	FC-5507	Oil Filter Full Flow.....	C-5510	Oil Filter Full Flow.....	C-5510
Hydraulic Oil Filter.....	H-5504	D4E (DOZERS) CAT (S/N: 46V9500-UP)		D4E (DOZERS)	
D4D (DOZERS) S/N: 84J1-1389		Oil Filter Full Flow.....	C-5510	Fuel Filter.....	F-5503
Air Filter Secondary.....	A-5567	D4E (DOZERS) CAT (S/N: 4YD1-1227)		D4E (DOZERS) S/N: 27X1-UP	
Air Filter Set.....	A-5568-S	Fuel Filter.....	FC-5501	Air Filter Secondary.....	A-5508
Air Filter Primary.....	A-5566	Oil Filter Full Flow.....	C-5510	Air Filter Primary.....	A-5507
Air Filter Primary.....	A-5507	Oil Filter Full Flow.....	C-5522	Air Filter Set.....	A-55071-S
Air Filter Set.....	A-5507-S	D4E (DOZERS) CAT (S/N: 4YD1228-1255)		Air Filter Set.....	A-5507-S
Air Filter Secondary.....	A-5508	Fuel Filter.....	FC-5501	Air Filter Primary.....	A-5566
Air Filter Set.....	A-55071-S	Oil Filter Full Flow.....	C-5522	Air Filter Secondary.....	A-5567
Fuel Filter Secondary.....	FC-5507	Oil Filter Full Flow.....	C-5510	Air Filter Set.....	A-5568-S
D4D (DOZERS) S/N: 84J1390-UP		D4E (DOZERS) CAT (S/N: 4YD1256-UP)		Fuel Filter Secondary.....	FC-5507
Air Filter Set.....	A-55071-S	Fuel Filter.....	FC-5501	Hydraulic Oil Filter.....	H-5504
Air Filter Secondary.....	A-5508	Oil Filter Full Flow.....	C-5522	Oil Filter Full Flow.....	C-5510
Air Filter Set.....	A-5507-S	D4E (DOZERS) CAT (S/N: 59Z1024-1385)		D4E (DOZERS) S/N: 28X1-1726	
Air Filter Primary.....	A-5507	Fuel Filter.....	FC-5501	Air Filter Set.....	A-5568-S
Air Filter Primary.....	A-5566	Oil Filter Full Flow.....	C-5510	Air Filter Secondary.....	A-5567
Air Filter Set.....	A-5568-S	D4E (DOZERS) CAT (S/N: 59Z1023)		Air Filter Primary.....	A-5566
Air Filter Secondary.....	A-5567	Fuel Filter.....	FC-5501	Air Filter Set.....	A-5507-S
Fuel Filter Secondary.....	FC-5507	Oil Filter Full Flow.....	C-5510	Air Filter Set.....	A-55071-S
Oil Filter Full Flow.....	C-5510	D4E (DOZERS) CAT (S/N: 59Z1386-UP)		Air Filter Primary.....	A-5507
D4E (DOZERS) CAT 3304		Fuel Filter.....	FC-5501	Air Filter Secondary.....	A-5508
Air Filter Primary.....	A-44180	Oil Filter Full Flow.....	C-5510	Fuel Filter Secondary.....	FC-5507
Air Filter Set.....	A-44180-S	D4E (DOZERS) CAT (S/N: 9CB1-141)		Hydraulic Oil Filter.....	H-5504
D4E (DOZERS) CAT (S/N: 07Z1004-5174)		Fuel Filter.....	FC-5501	Oil Filter Full Flow.....	C-5510
Fuel Filter Secondary.....	FC-5507	Oil Filter Full Flow.....	C-5510	D4E (DOZERS) S/N: 28X1727-UP	
Oil Filter Full Flow.....	C-5522	D4E (DOZERS) CAT (S/N: 07Z5175-7053)		Air Filter Primary.....	A-5566
Oil Filter Full Flow.....	C-5510	Fuel Filter Secondary.....	FC-5507	Air Filter Secondary.....	A-5567
D4E (DOZERS) CAT (S/N: 07Z5175-7053)		Oil Filter Full Flow.....	C-5510	Air Filter Set.....	A-5568-S
Fuel Filter Secondary.....	FC-5507	D4E (DOZERS) CAT (S/N: 9CB1-141)		Air Filter Secondary.....	A-5508
Oil Filter Full Flow.....	C-5510	Fuel Filter Secondary.....	FC-5507	Air Filter Primary.....	A-5507
Oil Filter Full Flow.....	C-5522	Oil Filter Full Flow.....	C-5510	Air Filter Set.....	A-55071-S
D4E (DOZERS) CAT (S/N: 07Z7054-32316)		Oil Filter Full Flow.....	C-5522	Air Filter Set.....	A-5507-S
Fuel Filter Secondary.....	FC-5507	D4E (DOZERS) CAT (S/N: 9CB142-682)		Fuel Filter Secondary.....	FC-5507
Oil Filter Full Flow.....	C-5522	Fuel Filter Secondary.....	FC-5507	Hydraulic Oil Filter.....	H-5504
Oil Filter Full Flow.....	C-5510	Oil Filter Full Flow.....	C-5522	Oil Filter Full Flow.....	C-5510
D4E (DOZERS) CAT (S/N: 07Z7054-32316)		Oil Filter Full Flow.....	C-5510	D4E (DOZERS) S/N: 28X1-UP	
Fuel Filter Secondary.....	FC-5507	D4E (DOZERS) CAT (S/N: 12Z1-11157)		Hydraulic Oil Filter.....	H-5504
Oil Filter Full Flow.....	C-5522	Air Filter Set.....	A-5522-S	Hydraulic Oil Filter.....	H-55270
Oil Filter Full Flow.....	C-5510	Air Filter Primary.....	A-5509	D4E (DOZERS) S/N: 29X1-UP	
D4E (DOZERS) CAT (S/N: 12Z1-11157)		Air Filter Secondary.....	A-5522	Air Filter Set.....	A-5568-S
Air Filter Set.....	A-5522-S	Fuel Filter Secondary.....	FC-5507	Air Filter Secondary.....	A-5567
Air Filter Primary.....	A-5509	Oil Filter Full Flow.....	C-5510	D4E (DOZERS) S/N: 29X1-UP	
Air Filter Secondary.....	A-5522	D4E (DOZERS) CAT S/N: 07Z32317-UP		Air Filter Set.....	A-5568-S
Fuel Filter Secondary.....	FC-5507	Fuel Filter Secondary.....	FC-5507	Air Filter Secondary.....	A-5567
Oil Filter Full Flow.....	C-5510	D4E (DOZERS) CAT S/N: 07Z32317-UP			
		Fuel Filter Secondary.....	FC-5507		

Sakura Filter

ENGINE APPLICATION

MODEL/APPLICATION	SAKURA NO	MODEL/APPLICATION	SAKURA NO	MODEL/APPLICATION	SAKURA NO
CATERPILLAR		CATERPILLAR		CATERPILLAR	
D4E (DOZERS) S/N: 29X1-UP Air Filter Primary..... A-5566 Air Filter Set..... A-5507-S Air Filter Set..... A-55071-S Air Filter Primary..... A-5507 Air Filter Secondary..... A-5508 Fuel Filter Secondary..... FC-5507 Hydraulic Oil Filter..... H-5504 Oil Filter Full Flow..... C-5510		Air Filter Set..... A-5568-S Hydraulic Oil Filter..... HC-5512 Hydraulic Oil Filter..... HC-5506 Hydraulic Oil Filter..... HC-5503 Hydraulic Oil Filter..... H-5504 D4E (DOZERS) S/N: 2DJ829-1765 Air Filter..... A-5546 Air Filter..... A-5530 Air Filter Primary..... A-5507 Air Filter Set..... A-55071-S Air Filter Set..... A-5507-S Hydraulic Oil Filter..... H-5504 D4E (DOZERS) S/N: 31C100-313 Air Filter Set..... A-5507-S Air Filter Set..... A-55071-S Air Filter Primary..... A-5507 Air Filter Secondary..... A-5508 Hydraulic Oil Filter..... H-5504 Hydraulic Oil Filter..... H-55270 D4E (DOZERS) S/N: 31C100-UP Air Filter Secondary..... A-5508 Air Filter Primary..... A-5507 Air Filter Set..... A-55071-S Air Filter Set..... A-5507-S Fuel Filter..... F-5505 Fuel Filter Secondary..... FC-5507 Hydraulic Oil Filter..... H-55270 Hydraulic Oil Filter..... H-5504 Oil Filter Full Flow..... C-5510 D4E (DOZERS) S/N: 2CB1-381 Air Filter..... A-5546 Hydraulic Oil Filter..... H-5504 D4E (DOZERS) S/N: 2CB1-UP Air Filter Set..... A-5522-S Air Filter Primary..... A-5509 Air Filter..... A-5530 Air Filter Primary..... A-5507 Air Filter Set..... A-55071-S Air Filter Set..... A-5507-S Fuel Filter..... F-5505 Fuel Filter Secondary..... FC-5507 Hydraulic Oil Filter..... H-55270 Hydraulic Oil Filter..... H-5504 Oil Filter Full Flow..... C-5510 D4E (DOZERS) S/N: 2CB382-UP Air Filter Set..... A-5507-S Air Filter Set..... A-55071-S Air Filter Primary..... A-5507 Air Filter..... A-5530 Air Filter..... A-5546 Hydraulic Oil Filter..... H-5504 D4E (DOZERS) S/N: 2DJ1766-1831 Air Filter..... A-5546 Air Filter..... A-5530 Air Filter Primary..... A-5507 Air Filter Set..... A-55071-S Air Filter Set..... A-5507-S Hydraulic Oil Filter..... HC-5503 Hydraulic Oil Filter..... HC-5506 Hydraulic Oil Filter..... HC-5512 Hydraulic Oil Filter..... H-5504 D4E (DOZERS) S/N: 2DJ1-828 Air Filter Set..... A-5507-S Air Filter Set..... A-55071-S Air Filter Primary..... A-5507 Air Filter..... A-5530 Hydraulic Oil Filter..... H-5504 D4E (DOZERS) S/N: 2DJ1832-UP Air Filter..... A-5546 Air Filter Primary..... A-5566 Air Filter Secondary..... A-5567		Fuel Filter Secondary..... FC-5507 Hydraulic Oil Filter..... H-5504 Oil Filter Full Flow..... C-5510 D4E (DOZERS) S/N: 51X1-841 Air Filter Secondary..... A-5508 Air Filter Primary..... A-5507 Air Filter Set..... A-55071-S Air Filter Set..... A-5507-S Fuel Filter Secondary..... FC-5507 Hydraulic Oil Filter..... H-5504 Oil Filter Full Flow..... C-5510 D4E (DOZERS) S/N: 51X842-UP Air Filter Set..... A-5507-S Air Filter Set..... A-55071-S Air Filter Primary..... A-5507 Air Filter Secondary..... A-5508 Fuel Filter Secondary..... FC-5507 Hydraulic Oil Filter..... H-55270 Hydraulic Oil Filter..... H-5504 Oil Filter Full Flow..... C-5510 D4E (DOZERS) S/N: 52X1-1162 Air Filter Primary..... A-5566 Air Filter Set..... A-5568-S Air Filter Secondary..... A-5567 Air Filter Secondary..... A-5508 Air Filter Primary..... A-5507 Air Filter Set..... A-55071-S Air Filter Set..... A-5507-S Fuel Filter Secondary..... FC-5507 Hydraulic Oil Filter..... H-5504 Oil Filter Full Flow..... C-5510 D4E (DOZERS) S/N: 52X1163-UP Air Filter Set..... A-5507-S Air Filter Set..... A-55071-S Air Filter Primary..... A-5507 Air Filter Secondary..... A-5508 Air Filter Secondary..... A-5567 Air Filter Set..... A-5568-S Air Filter Primary..... A-5566 Fuel Filter Secondary..... FC-5507 Hydraulic Oil Filter..... H-5504 Oil Filter Full Flow..... C-5510 D4E (DOZERS) S/N: 68X1-UP Air Filter Secondary..... A-5508 Air Filter Primary..... A-5507 Air Filter Set..... A-55071-S Air Filter Set..... A-5507-S Fuel Filter Secondary..... FC-5507 Hydraulic Oil Filter..... H-5504 Oil Filter Full Flow..... C-5510 D4E (DOZERS) S/N: 68X767-851 Hydraulic Oil Filter..... H-5504 D4E (DOZERS) S/N: 68X852-871 Hydraulic Oil Filter..... H-5504	

Sakura Filter

ENGINE APPLICATION

MODEL/APPLICATION	SAKURA NO	MODEL/APPLICATION	SAKURA NO	MODEL/APPLICATION	SAKURA NO
CATERPILLAR		CATERPILLAR		CATERPILLAR	
D4E (DOZERS) S/N: 68X872-UP Air Filter..... A-5546 Hydraulic Oil Filter..... H-5504		Air Filter..... A-5546 Hydraulic Oil Filter..... H-5504 D4E (DOZERS) S/N: 72X1-UP Air Filter Primary..... A-5566 Air Filter Set..... A-5568-S Air Filter Secondary..... A-5567 Air Filter Secondary..... A-5508 Air Filter Primary..... A-5507 Air Filter Set..... A-55071-S Air Filter Set..... A-5507-S Fuel Filter Secondary..... FC-5507 Hydraulic Oil Filter..... H-5504 Oil Filter Full Flow..... C-5510		D4E (DOZERS) S/N: 77W1-1143 Air Filter Set..... A-5507-S Air Filter Set..... A-55071-S Air Filter Primary..... A-5507 Air Filter Secondary..... A-5508 Hydraulic Oil Filter..... H-5504 Hydraulic Oil Filter..... H-55270	
D4E (DOZERS) S/N: 69X1425-1503 Hydraulic Oil Filter..... H-5504		Air Filter Set..... A-55071-S Air Filter Set..... A-5507-S Fuel Filter Secondary..... FC-5507 Hydraulic Oil Filter..... H-5504 Oil Filter Full Flow..... C-5510 D4E (DOZERS) S/N: 72X639-650 Hydraulic Oil Filter..... H-5504		D4E (DOZERS) S/N: 77W1144-1663 Air Filter Secondary..... A-5508 Air Filter..... A-5530 Air Filter Primary..... A-5507 Air Filter Set..... A-55071-S Air Filter Set..... A-5507-S Hydraulic Oil Filter..... H-55270 Hydraulic Oil Filter..... H-5504	
D4E (DOZERS) S/N: 69X1504-1531 Hydraulic Oil Filter..... H-5504		D4E (DOZERS) S/N: 72X666-UP Air Filter..... A-5546 Hydraulic Oil Filter..... H-5504		D4E (DOZERS) S/N: 77W1664-UP Air Filter..... A-5546 Air Filter Set..... A-5507-S Air Filter Set..... A-55071-S Air Filter Primary..... A-5507 Air Filter..... A-5530 Air Filter Secondary..... A-5508 Hydraulic Oil Filter..... H-5504 Hydraulic Oil Filter..... H-55270	
D4E (DOZERS) S/N: 69X1532-UP Air Filter..... A-5546 Hydraulic Oil Filter..... H-5504		D4E (DOZERS) S/N: 76W1-2504 Air Filter Set..... A-5507-S Air Filter Set..... A-55071-S Air Filter Primary..... A-5507 Air Filter Secondary..... A-5508 Hydraulic Oil Filter..... H-5504		D4E (DOZERS) S/N: 77W1-UP Air Filter Secondary..... A-5508 Air Filter Primary..... A-5507 Air Filter Set..... A-55071-S Air Filter Set..... A-5507-S Air Filter Primary..... A-5566 Air Filter Set..... A-5568-S Air Filter Primary..... A-5507 Air Filter Set..... A-55071-S Air Filter Set..... A-5507-S Fuel Filter Secondary..... FC-5507 Hydraulic Oil Filter..... H-5504 Oil Filter Full Flow..... C-5510	
D4E (DOZERS) S/N: 69X1-UP Air Filter Set..... A-5507-S Air Filter Set..... A-55071-S Air Filter Primary..... A-5507 Air Filter Secondary..... A-5508 Fuel Filter Secondary..... FC-5507 Hydraulic Oil Filter..... H-5504 Oil Filter Full Flow..... C-5510		D4E (DOZERS) S/N: 76W1-UP Air Filter Primary..... A-5566 Air Filter Secondary..... A-5567 Air Filter Set..... A-5568-S Air Filter Secondary..... A-5508 Air Filter Primary..... A-5507 Air Filter Set..... A-55071-S Air Filter Set..... A-5507-S Fuel Filter Secondary..... FC-5507 Hydraulic Oil Filter..... H-5504 Oil Filter Full Flow..... C-5510		D4E (DOZERS) S/N: 7PB1-649 Hydraulic Oil Filter..... H-5504	
D4E (DOZERS) S/N: 70X1-UP Air Filter Secondary..... A-5508 Air Filter Primary..... A-5507 Air Filter Set..... A-55071-S Air Filter Set..... A-5507-S Fuel Filter Secondary..... FC-5507 Hydraulic Oil Filter..... H-5504 Oil Filter Full Flow..... C-5510		D4E (DOZERS) S/N: 76W2505-3167 Air Filter Set..... A-5507-S Air Filter Set..... A-55071-S Air Filter Primary..... A-5507 Air Filter Secondary..... A-5508 Air Filter..... A-5530 Hydraulic Oil Filter..... H-5504		D4E (DOZERS) S/N: 7PB1-UP Air Filter Set..... A-5507-S Air Filter Set..... A-55071-S Air Filter Primary..... A-5507 Air Filter..... A-5530 Air Filter Primary..... A-5509 Air Filter Set..... A-5522-S Fuel Filter..... F-5505 Fuel Filter Secondary..... FC-5507 Hydraulic Oil Filter..... H-55270 Hydraulic Oil Filter..... H-5504 Oil Filter Full Flow..... C-5510	
D4E (DOZERS) S/N: 70X825-902 Hydraulic Oil Filter..... H-5504		D4E (DOZERS) S/N: 76W3168-UP Air Filter..... A-5546 Air Filter..... A-5530 Air Filter Secondary..... A-5508 Air Filter Primary..... A-5507 Air Filter Set..... A-55071-S Air Filter Set..... A-5507-S Hydraulic Oil Filter..... H-5504		D4E (DOZERS) S/N: 7PB650-UP Air Filter..... A-5530	
D4E (DOZERS) S/N: 70X903-920 Hydraulic Oil Filter..... H-5504		D4E (DOZERS) S/N: 71X1-UP Air Filter Set..... A-5507-S Air Filter Set..... A-55071-S Air Filter Primary..... A-5507 Air Filter Secondary..... A-5508 Fuel Filter Secondary..... FC-5507 Hydraulic Oil Filter..... H-5504 Oil Filter Full Flow..... C-5510			
D4E (DOZERS) S/N: 70X921-UP Air Filter..... A-5546 Hydraulic Oil Filter..... H-5504		D4E (DOZERS) S/N: 71X426-429 Hydraulic Oil Filter..... H-5504			
D4E (DOZERS) S/N: 71X430-UP					

MODEL/APPLICATION	SAKURA NO
CATERPILLAR	
D4E (DOZERS) S/N: 7PB650-UP	
Air Filter Primary.....	A-5507
Air Filter Set.....	A-55071-S
Air Filter Set.....	A-5507-S
Hydraulic Oil Filter.....	H-5504
D4E (DOZERS) w/3304 Eng.	
Hydraulic Oil Filter.....	H-55320
D4E SR (DOZERS) w/3304 Eng.	
Hydraulic Oil Filter.....	H-55320
D4G (DOZERS) CAT (S/N: 5XK30700-UP)	
Fuel Filter.....	FC-5516
Fuel Filter Secondary.....	FC-55151
Fuel Filter Secondary.....	FC-5515
Oil Filter Full Flow.....	C-5504
D4G (DOZERS) CAT (S/N: MHK1-UP)	
Fuel Filter.....	FC-5516
Fuel Filter Secondary.....	FC-5515
Fuel Filter Secondary.....	FC-55151
Oil Filter Full Flow.....	C-5504
D4G (DOZERS) CAT 3046 T	
Air Filter Secondary.....	A-4402
Oil Filter Full Flow.....	C-6218
D4G (DOZERS) S/N: CFN1-UP	
Hydraulic Oil Filter.....	HC-5507
Hydraulic Oil Filter.....	HC-5504
Hydraulic Oil Filter.....	HC-55220
D4G (DOZERS) S/N: FDC1-UP	
Hydraulic Oil Filter.....	HC-55220
Hydraulic Oil Filter.....	HC-5504
Hydraulic Oil Filter.....	HC-5507
D4G (DOZERS) S/N: HYD1-UP	
Hydraulic Oil Filter.....	HC-5507
Hydraulic Oil Filter.....	HC-5504
Hydraulic Oil Filter.....	HC-55220
D4G (DOZERS) S/N: TLX1-UP	
Hydraulic Oil Filter.....	HC-55220
Hydraulic Oil Filter.....	HC-5504
Hydraulic Oil Filter.....	HC-5507
D4 G XL (DOZERS) CAT 3046 T	
Air Filter Secondary.....	A-4402
Oil Filter Full Flow.....	C-6218
D4H (DOZERS) CAT (S/N: 45V47656-69452)	
Oil Filter Full Flow.....	C-5505

MODEL/APPLICATION	SAKURA NO
CATERPILLAR	
D4H (DOZERS) CAT (S/N: 45V69453-UP)	
Fuel Filter.....	FC-5501
Oil Filter Full Flow.....	C-5505
D4H (DOZERS) CAT (S/N: 7YJ1-3152)	
Fuel Filter Secondary.....	FC-5507
Fuel Filter.....	FC-5501
Oil Filter Full Flow.....	C-5505
Oil Filter Full Flow.....	C-5519
D4H (DOZERS) CAT (S/N: 7YJ3153-UP)	
Fuel Filter.....	FC-5501
Fuel Filter Secondary.....	FC-5507
Oil Filter Full Flow.....	C-5519
Oil Filter Full Flow.....	C-5505
D4H (DOZERS) CAT 3204	
Cabin Air Filter.....	CA-55140
D4H (DOZERS) S/N: 1WB1-UP	
Hydraulic Oil Filter.....	H-5501
D4H (DOZERS) S/N: 2AC1-375	
Air Filter Primary.....	A-5507
Air Filter Set.....	A-5507-S
Air Filter Set.....	A-55071-S
Air Filter.....	A-5530
Hydraulic Oil Filter.....	H-55270
D4H (DOZERS) S/N: 2AC1-3999	
Air Filter.....	A-5530
Air Filter Set.....	A-55071-S
Air Filter Set.....	A-5507-S
Air Filter Primary.....	A-5507
Fuel Filter Secondary.....	FC-5507
Hydraulic Oil Filter.....	H-5504
Hydraulic Oil Filter.....	H-55270
Oil Filter Full Flow.....	C-5505
D4H (DOZERS) S/N: 2AC376-551	
Air Filter Primary.....	A-5507
Air Filter Set.....	A-5507-S
Air Filter Set.....	A-55071-S
Air Filter.....	A-5530
Hydraulic Oil Filter.....	H-55270
D4H (DOZERS) S/N: 2AC4000-UP	
Air Filter Set.....	A-55071-S
Air Filter Set.....	A-5507-S
Air Filter Primary.....	A-5507
Air Filter.....	A-5530
Fuel Filter Secondary.....	FC-5507
Fuel Filter.....	F-5505
Hydraulic Oil Filter.....	H-5504
Hydraulic Oil Filter.....	H-55270
Oil Filter Full Flow.....	C-5505
D4H (DOZERS) S/N: 2AC582-UP	
Air Filter Primary.....	A-5507
Air Filter Set.....	A-55071-S

MODEL/APPLICATION	SAKURA NO
CATERPILLAR	
D4H (DOZERS) S/N: 2AC5500-UP	
Hydraulic Oil Filter.....	H-5504
Hydraulic Oil Filter.....	H-55270
D4H (DOZERS) S/N: 2AC552-5499	
Air Filter.....	A-5530
Air Filter Primary.....	A-5507
Air Filter Set.....	A-5507-S
Air Filter Set.....	A-55071-S
Hydraulic Oil Filter.....	H-5504
Hydraulic Oil Filter.....	H-55270
D4H (DOZERS) S/N: 2CC1-UP	
Hydraulic Oil Filter.....	H-5501
D4H (DOZERS) S/N: 3AC1-388	
Air Filter Primary.....	A-5507
Air Filter Set.....	A-55071-S
Air Filter Set.....	A-5507-S
Air Filter.....	A-5530
Hydraulic Oil Filter.....	H-55270
D4H (DOZERS) S/N: 3AC1-3999	
Air Filter Set.....	A-5568-S
Air Filter Secondary.....	A-5567
Air Filter Primary.....	A-5566
Air Filter Set.....	A-5507-S
Air Filter Set.....	A-55071-S
Air Filter Primary.....	A-5507
Air Filter.....	A-5530
Fuel Filter Secondary.....	FC-5507
Hydraulic Oil Filter.....	H-55280
Hydraulic Oil Filter.....	H-5504
Oil Filter Full Flow.....	C-5505
D4H (DOZERS) S/N: 3AC389-581	
Air Filter Primary.....	A-5507
Air Filter Set.....	A-55071-S
Air Filter Set.....	A-5507-S
Air Filter.....	A-5530
Hydraulic Oil Filter.....	H-55270
D4H (DOZERS) S/N: 3AC4000-UP	
Air Filter.....	A-5530
Air Filter Set.....	A-5507-S
Air Filter Set.....	A-55071-S
Air Filter Primary.....	A-5507
Fuel Filter Secondary.....	FC-5507
Fuel Filter.....	F-5505
Hydraulic Oil Filter.....	H-5504
Hydraulic Oil Filter.....	H-55270
Oil Filter Full Flow.....	C-5505
D4H (DOZERS) S/N: 3AC582-UP	
Air Filter Primary.....	A-5507
Air Filter Set.....	A-55071-S

MODEL/APPLICATION	SAKURA NO
CATERPILLAR	
D4H (DOZERS) S/N: 3AC582-UP	
Air Filter Set.....	A-5507-S
Air Filter.....	A-5530
Hydraulic Oil Filter.....	H-55270
Hydraulic Oil Filter.....	H-5504
D4H (DOZERS) S/N: 4NK1-UP	
Air Filter.....	A-5530
Air Filter Set.....	A-5507-S
Air Filter Set.....	A-55071-S
Air Filter Primary.....	A-5507
Hydraulic Oil Filter.....	H-5504
Oil Filter Full Flow.....	C-5505
D4H (DOZERS) S/N: 8PB1-3999	
Air Filter Primary.....	A-5507
Air Filter Set.....	A-55071-S
Air Filter Set.....	A-5507-S
Air Filter.....	A-5530
Fuel Filter Secondary.....	FC-5507
Hydraulic Oil Filter.....	H-55270
Hydraulic Oil Filter.....	H-5504
Oil Filter Full Flow.....	C-5505
D4H (DOZERS) S/N: 8PB1-UP	
Air Filter.....	A-5530
Air Filter Set.....	A-5507-S
Air Filter Set.....	A-55071-S
Air Filter Primary.....	A-5507
Hydraulic Oil Filter.....	H-55270
D4H (DOZERS) S/N: 8PB4000-UP	
Air Filter Primary.....	A-5507
Air Filter Set.....	A-55071-S
Air Filter Set.....	A-5507-S
Air Filter.....	A-5530
Fuel Filter Secondary.....	FC-5507
Fuel Filter.....	F-5505
Hydraulic Oil Filter.....	H-5504
Hydraulic Oil Filter.....	H-55270
Oil Filter Full Flow.....	C-5505
D4H (DOZERS) S/N: 9DB1-3999	
Air Filter.....	A-5530
Air Filter Set.....	A-5507-S
Air Filter Set.....	A-55071-S
Air Filter Primary.....	A-5507
Hydraulic Oil Filter.....	H-55270
D4H (DOZERS) S/N: 9DB1-UP	
Air Filter Primary.....	A-5507
Air Filter Set.....	A-55071-S
Air Filter Set.....	A-5507-S
Air Filter.....	A-5530
Fuel Filter Secondary.....	FC-5507
Hydraulic Oil Filter.....	H-55270
Hydraulic Oil Filter.....	H-5504
Oil Filter Full Flow.....	C-5505

MODEL/APPLICATION	SAKURA NO
CATERPILLAR	
Hydraulic Oil Filter.....	H-55270
D4H (DOZERS) S/N: 9DB4000-UP	
Air Filter Set.....	A-5507-S
Air Filter Set.....	A-55071-S
Air Filter Primary.....	A-5507
Air Filter.....	A-5530
Fuel Filter Secondary.....	FC-5507
Fuel Filter.....	F-5505
Hydraulic Oil Filter.....	H-5504
Hydraulic Oil Filter.....	H-55270
Oil Filter Full Flow.....	C-5505
D4H (DOZERS) S/N: 9FB1-UP	
Hydraulic Oil Filter.....	H-5501
D4H (DOZERS) S/N: 9GJ1-UP	
Air Filter.....	A-5530
Air Filter Primary.....	A-5507
Air Filter Set.....	A-55071-S
Air Filter Set.....	A-5507-S
Fuel Filter Secondary.....	FC-5507
Hydraulic Oil Filter.....	H-5504
Oil Filter Full Flow.....	C-5505
D4H II (DOZERS) CAT 3204	
Cabin Air Filter.....	CA-55140
D4H III (DOZERS) CAT 3304	
Cabin Air Filter.....	CA-55140
D4H LGP (DOZERS) CAT 3204	
Cabin Air Filter.....	CA-55140
D4H LGP (DOZERS) S/N: 2AC1-3999	
Air Filter.....	A-5530
Air Filter Set.....	A-55071-S
Air Filter Set.....	A-5507-S
Air Filter Primary.....	A-5507
Fuel Filter Secondary.....	FC-5507
Hydraulic Oil Filter.....	H-5504
Hydraulic Oil Filter.....	H-55270
Oil Filter Full Flow.....	C-5505
D4H LGP (DOZERS) S/N: 2AC4000-UP	
Air Filter Primary.....	A-5507
Air Filter Set.....	A-5507-S
Air Filter Set.....	A-55071-S
Air Filter.....	A-5530
Fuel Filter.....	F-5505
Fuel Filter Secondary.....	FC-5507
Hydraulic Oil Filter.....	H-55270
Hydraulic Oil Filter.....	H-5504
Oil Filter Full Flow.....	C-5505
D4H LGP (DOZERS) S/N: 3AC1-3999	
Air Filter.....	A-5530

MODEL/APPLICATION	SAKURA NO
CATERPILLAR	
Air Filter Set.....	A-55071-S
Air Filter Set.....	A-5507-S
Air Filter Primary.....	A-5507
Fuel Filter Secondary.....	FC-5507
Hydraulic Oil Filter.....	H-5504
Hydraulic Oil Filter.....	H-55270
Oil Filter Full Flow.....	C-5505
D4H LGP (DOZERS) S/N: 4NK1-4NK1	
Air Filter Primary.....	A-5566
Air Filter Secondary.....	A-5567
Air Filter Set.....	A-5568-S
D4H LGP (DOZERS) S/N: 4NK1-UP	
Air Filter Set.....	A-5568-S
Air Filter Secondary.....	A-5567
Air Filter Primary.....	A-5566
Air Filter Primary.....	A-5507
Air Filter Set.....	A-5507-S
Air Filter Set.....	A-55071-S
Air Filter.....	A-5530
Fuel Filter Secondary.....	FC-5507
Hydraulic Oil Filter.....	H-55270
Hydraulic Oil Filter.....	H-5504
Oil Filter Full Flow.....	C-5510
D4H LGP (DOZERS) S/N: 8PB1-3999	
Air Filter.....	A-5530
Air Filter Set.....	A-55071-S
Air Filter Set.....	A-5507-S
Air Filter Primary.....	A-5507
Fuel Filter Secondary.....	FC-5507
Hydraulic Oil Filter.....	H-5504
Hydraulic Oil Filter.....	H-55270
Oil Filter Full Flow.....	C-5505
D4H LGP (DOZERS) S/N: 9DB1-3999	
Air Filter Primary.....	A-5507
Air Filter Set.....	A-5507-S
Air Filter Set.....	A-55071-S
Air Filter.....	A-5530
Fuel Filter Secondary.....	FC-5507
Hydraulic Oil Filter.....	H-55270
Hydraulic Oil Filter.....	H-5504
Oil Filter Full Flow.....	C-5505
D4H LGP (DOZERS) S/N: 9GJ1-UP	
Air Filter Primary.....	A-5566
Air Filter Secondary.....	A-5567
Air Filter Set.....	A-5568-S
D4H LGP SERIES II (DOZERS) S/N: 3AC4000-UP	
Air Filter Primary.....	A-5507
Air Filter Set.....	A-5507-S
Air Filter Set.....	A-55071-S
Air Filter.....	A-5530
Fuel Filter Secondary.....	FC-5507
Hydraulic Oil Filter.....	H-55270
Hydraulic Oil Filter.....	H-5504

Sakura Filter

ENGINE APPLICATION

MODEL/APPLICATION	SAKURA NO	MODEL/APPLICATION	SAKURA NO	MODEL/APPLICATION	SAKURA NO
CATERPILLAR		CATERPILLAR		CATERPILLAR	
D4H LGP SERIES II (DOZERS) S/N: 3AC4000-UP		Fuel Filter.....	FC-5501	D4H SERIES II (DOZERS) S/N: 3AC582-UP	
Oil Filter Full Flow.....	C-5505	Oil Filter Full Flow.....	C-5505	Air Filter.....	A-5530
D4H LGP SERIES II (DOZERS) S/N: 8PB4000-UP		D4H SERIES II (DOZERS) CAT (S/N: 7BG1-UP)		Air Filter Set.....	A-55071-S
Air Filter.....	A-5530	Hydraulic Oil Filter.....	H-5501	Air Filter Set.....	A-5507-S
Air Filter Set.....	A-55071-S	D4H SERIES II (DOZERS) CAT (S/N: 7YJ1-3152)		Air Filter Primary.....	A-5507
Air Filter Set.....	A-5507-S	Fuel Filter Secondary.....	FC-5507	Hydraulic Oil Filter.....	H-55270
Air Filter Primary.....	A-5507	Fuel Filter.....	FC-5501	Hydraulic Oil Filter.....	H-5504
Fuel Filter Secondary.....	FC-5507	Oil Filter Full Flow.....	C-5519	D4H SERIES II (DOZERS) S/N: 8PB1-UP	
Fuel Filter.....	F-5505	Oil Filter Full Flow.....	C-5505	Air Filter Primary.....	A-5507
Hydraulic Oil Filter.....	H-5504	D4H SERIES II (DOZERS) CAT (S/N: 7YJ3153-UP)		Air Filter Set.....	A-5507-S
Hydraulic Oil Filter.....	H-55270	Fuel Filter Secondary.....	FC-5507	Air Filter Set.....	A-55071-S
Oil Filter Full Flow.....	C-5505	Fuel Filter.....	FC-5501	Air Filter.....	A-5530
D4H LGP SERIES II (DOZERS) S/N: 9DB4000-UP		Oil Filter Full Flow.....	C-5505	Hydraulic Oil Filter.....	H-55270
Air Filter.....	A-5530	Oil Filter Full Flow.....	C-5519	D4H SERIES II (DOZERS) S/N: 9DB1-UP	
Air Filter Primary.....	A-5507	D4H SERIES II (DOZERS) S/N: 2AC1-375		Air Filter.....	A-5530
Air Filter Set.....	A-5507-S	Air Filter Primary.....	A-5507	Air Filter Set.....	A-55071-S
Air Filter Set.....	A-55071-S	Air Filter Set.....	A-5507-S	Air Filter Set.....	A-5507-S
Fuel Filter.....	F-5505	Air Filter Set.....	A-55071-S	Air Filter Primary.....	A-5507
Fuel Filter Secondary.....	FC-5507	Air Filter.....	A-5530	Hydraulic Oil Filter.....	H-55270
Hydraulic Oil Filter.....	H-55270	Hydraulic Oil Filter.....	H-55270	D4H SERIES III (DOZERS) CAT S/N: 09Z10600-UP	
Hydraulic Oil Filter.....	H-5504	D4H SERIES II (DOZERS) S/N: 2AC376-551		Air Filter.....	A-5530
Oil Filter Full Flow.....	C-5505	Air Filter.....	A-5530	Air Filter Set.....	A-55071-S
D4H LGP SERIES III (DOZERS) S/N: 8PJ1-UP		Air Filter Set.....	A-55071-S	Air Filter Set.....	A-5507-S
Air Filter.....	A-5530	Air Filter Set.....	A-5507-S	Air Filter Primary.....	A-5507
Air Filter Set.....	A-55071-S	Air Filter Set.....	A-5507-S	Air Filter Primary.....	A-5566
Air Filter Set.....	A-5507-S	Air Filter Primary.....	A-5507	Air Filter Secondary.....	A-5567
Air Filter Primary.....	A-5507	Hydraulic Oil Filter.....	H-55270	Air Filter Set.....	A-5568-S
Air Filter Set.....	A-5568-S	D4H SERIES II (DOZERS) S/N: 2AC5500-UP		Fuel Filter Secondary.....	FC-5507
Air Filter Secondary.....	A-5567	Hydraulic Oil Filter.....	H-55270	Hydraulic Oil Filter.....	H-5504
Air Filter Primary.....	A-5566	Hydraulic Oil Filter.....	H-5504	Hydraulic Oil Filter.....	H-55270
Fuel Filter.....	F-5505	D4H SERIES II (DOZERS) S/N: 2AC552-5499		Oil Filter Full Flow.....	C-5522
Fuel Filter Secondary.....	FC-5507	Air Filter Primary.....	A-5507	D4H SERIES III (DOZERS) CAT S/N: 4NK1-UP	
Hydraulic Oil Filter.....	H-5504	Air Filter Set.....	A-5507-S	Air Filter Set.....	A-5568-S
Hydraulic Oil Filter.....	H-55270	Air Filter Set.....	A-55071-S	Air Filter Secondary.....	A-5567
Oil Filter Full Flow.....	C-5510	Air Filter.....	A-5530	Air Filter Primary.....	A-5566
D4H LGP SERIES III (DOZERS) S/N: 9GJ1-UP		Hydraulic Oil Filter.....	H-5504	Air Filter Primary.....	A-5507
Air Filter Set.....	A-55071-S	Hydraulic Oil Filter.....	H-55270	Air Filter Set.....	A-5507-S
Air Filter.....	A-5530	D4H SERIES II (DOZERS) S/N: 3AC1-388		Air Filter Set.....	A-55071-S
Air Filter Primary.....	A-5566	Air Filter.....	A-5530	Air Filter.....	A-5530
Air Filter Secondary.....	A-5567	Air Filter Set.....	A-55071-S	Fuel Filter Secondary.....	FC-5507
Air Filter Set.....	A-5568-S	Air Filter Set.....	A-55071-S	Hydraulic Oil Filter.....	H-55270
Air Filter Primary.....	A-5507	Air Filter Set.....	A-5507-S	Hydraulic Oil Filter.....	H-5504
Air Filter Set.....	A-5507-S	Air Filter Primary.....	A-5507	Oil Filter Full Flow.....	C-5522
Fuel Filter.....	F-5505	Hydraulic Oil Filter.....	H-55270	D4H TSK (SKIDDERS) S/N: 8ZF1-UP	
Fuel Filter Secondary.....	FC-5507	D4H SERIES II (DOZERS) S/N: 3AC389-581		Air Filter Primary.....	A-5507
Hydraulic Oil Filter.....	H-55270	Air Filter Primary.....	A-5507	Air Filter Set.....	A-5507-S
Hydraulic Oil Filter.....	H-5504	Air Filter Set.....	A-5507-S	Air Filter Set.....	A-55071-S
Oil Filter Full Flow.....	C-5510	Air Filter Set.....	A-55071-S	Air Filter.....	A-5530
D4H SERIES II (DOZERS) CAT (S/N: 45V47656-69452)		Air Filter.....	A-5530	Fuel Filter Secondary.....	FC-5507
Oil Filter Full Flow.....	C-5505	Hydraulic Oil Filter.....	H-55270	Hydraulic Oil Filter.....	H-5504
D4H SERIES II (DOZERS) CAT (S/N: 45V69453-UP)		D4H SERIES II (DOZERS) S/N: 3AC389-581		Oil Filter Full Flow.....	C-5505
Air Filter Primary.....	A-5507	Air Filter Primary.....	A-5507		
Air Filter Set.....	A-5507-S	Air Filter Set.....	A-5507-S		
Air Filter Set.....	A-55071-S	Air Filter Set.....	A-55071-S		
Air Filter.....	A-5530	Air Filter Primary.....	A-5507		
Hydraulic Oil Filter.....	H-55270	Hydraulic Oil Filter.....	H-55270		

MODEL/APPLICATION	SAKURA NO
CATERPILLAR	

**D5
(DOZERS)
S/N: 83H1-455**

Air Filter Set.....	A-5568-S
Air Filter Secondary.....	A-5567
Air Filter Primary.....	A-5566
Air Filter Primary.....	A-5507
Air Filter Set.....	A-5507-S
Air Filter Set.....	A-55071-S
Air Filter Secondary.....	A-5508
Hydraulic Oil Filter.....	H-5504
Oil Filter Full Flow.....	O-5502

**D5
(DOZERS)
S/N: 84H1-809**

Air Filter Secondary.....	A-5508
Air Filter Set.....	A-55071-S
Air Filter Set.....	A-5507-S
Air Filter Primary.....	A-5507
Air Filter Primary.....	A-5566
Air Filter Secondary.....	A-5567
Air Filter Set.....	A-5568-S
Hydraulic Oil Filter.....	H-5504
Oil Filter Full Flow.....	O-5502

**D5
(DOZERS)
S/N: 93J1-731**

Air Filter Secondary.....	A-5550
Air Filter Set.....	A-5549M-S
Air Filter Primary.....	A-5549M
Air Filter Primary.....	A-5549
Air Filter Primary.....	A-5509
Air Filter Secondary.....	A-5510
Air Filter Set.....	A-5522-S
Fuel Filter Secondary.....	FC-5507
Hydraulic Oil Filter.....	H-5504
Oil Filter Full Flow.....	C-5510

**D5
(DOZERS)
S/N: 93J732-904**

Air Filter Set.....	A-5522-S
Air Filter Secondary.....	A-5510
Air Filter Primary.....	A-5509
Air Filter Primary.....	A-5549
Air Filter Primary.....	A-5549M
Air Filter Set.....	A-5549M-S
Air Filter Secondary.....	A-5550
Fuel Filter Secondary.....	FC-5507
Hydraulic Oil Filter.....	H-5504
Oil Filter Full Flow.....	C-5510

**D5
(DOZERS)
S/N: 93J905-UP**

Air Filter Secondary.....	A-5550
Air Filter Set.....	A-5549M-S
Air Filter Primary.....	A-5549M
Air Filter Primary.....	A-5549
Air Filter Primary.....	A-5509
Air Filter Secondary.....	A-5510
Air Filter Set.....	A-5522-S
Fuel Filter Secondary.....	FC-5507
Hydraulic Oil Filter.....	H-5504
Oil Filter Full Flow.....	C-5510

MODEL/APPLICATION	SAKURA NO
CATERPILLAR	

**D5
(DOZERS)
S/N: 94J1-1704**

Air Filter Set.....	A-5522-S
Air Filter Secondary.....	A-5510
Air Filter Primary.....	A-5509
Air Filter Primary.....	A-5549
Air Filter Primary.....	A-5549M
Air Filter Set.....	A-5549M-S
Air Filter Secondary.....	A-5550
Fuel Filter Secondary.....	FC-5507
Hydraulic Oil Filter.....	H-5504
Oil Filter Full Flow.....	O-5502

**D5
(DOZERS)
S/N: 94J1705-2448**

Air Filter Secondary.....	A-5550
Air Filter Set.....	A-5549M-S
Air Filter Primary.....	A-5549M
Air Filter Primary.....	A-5549
Air Filter Primary.....	A-5509
Air Filter Secondary.....	A-5510
Air Filter Set.....	A-5522-S
Fuel Filter Secondary.....	FC-5507
Hydraulic Oil Filter.....	H-5504
Oil Filter Full Flow.....	C-5510

**D5
(DOZERS)
S/N: 94J2449-UP**

Air Filter Set.....	A-5522-S
Air Filter Secondary.....	A-5510
Air Filter Primary.....	A-5509
Air Filter Primary.....	A-5549
Air Filter Primary.....	A-5549M
Air Filter Set.....	A-5549M-S
Air Filter Secondary.....	A-5550
Fuel Filter Secondary.....	FC-5507
Hydraulic Oil Filter.....	H-5504
Oil Filter Full Flow.....	C-5510

**D5
(DOZERS)
S/N: 95J1-356**

Air Filter Secondary.....	A-5550
Air Filter Set.....	A-5549M-S
Air Filter Primary.....	A-5549M
Air Filter Primary.....	A-5549
Air Filter Primary.....	A-5509
Air Filter Secondary.....	A-5510
Air Filter Set.....	A-5522-S
Hydraulic Oil Filter.....	H-5504
Oil Filter Full Flow.....	C-5510

**D5
(DOZERS)
S/N: 95J357-UP**

Air Filter Set.....	A-5522-S
Air Filter Secondary.....	A-5510
Air Filter Primary.....	A-5509
Air Filter Primary.....	A-5549
Air Filter Primary.....	A-5549M
Air Filter Set.....	A-5549M-S
Air Filter Secondary.....	A-5550
Hydraulic Oil Filter.....	H-5504
Oil Filter Full Flow.....	C-5510

MODEL/APPLICATION	SAKURA NO
CATERPILLAR	

**D5
(DOZERS)
S/N: 96J1-3587**

Air Filter Secondary.....	A-5550
Air Filter Set.....	A-5549M-S
Air Filter Primary.....	A-5549M
Air Filter Primary.....	A-5549
Air Filter Primary.....	A-5509
Air Filter Secondary.....	A-5510
Air Filter Set.....	A-5522-S
Hydraulic Oil Filter.....	H-5504
Oil Filter Full Flow.....	C-5510

**D5
(DOZERS)
S/N: 96J3588-5261**

Air Filter Set.....	A-5522-S
Air Filter Secondary.....	A-5510
Air Filter Primary.....	A-5509
Air Filter Primary.....	A-5549
Air Filter Primary.....	A-5549M
Air Filter Set.....	A-5549M-S
Air Filter Secondary.....	A-5550
Hydraulic Oil Filter.....	H-5504
Oil Filter Full Flow.....	C-5510

**D5
(DOZERS)
S/N: 98J1-1133**

Air Filter Secondary.....	A-5550
Air Filter Set.....	A-5549M-S
Air Filter Primary.....	A-5549M
Air Filter Primary.....	A-5549
Air Filter Primary.....	A-5509
Air Filter Secondary.....	A-5510
Air Filter Set.....	A-5522-S
Fuel Filter Secondary.....	FC-5507
Hydraulic Oil Filter.....	H-5504
Oil Filter Full Flow.....	C-5510

**D5
(DOZERS)
S/N: 98J1134-1590**

Air Filter Set.....	A-5522-S
Air Filter Secondary.....	A-5510
Air Filter Primary.....	A-5509
Air Filter Primary.....	A-5549
Air Filter Primary.....	A-5549M
Air Filter Set.....	A-5549M-S
Air Filter Secondary.....	A-5550
Fuel Filter Secondary.....	FC-5507
Hydraulic Oil Filter.....	H-5504
Oil Filter Full Flow.....	C-5510

**D5
(DOZERS)
S/N: 98J1591-UP**

Air Filter Secondary.....	A-5550
Air Filter Set.....	A-5549M-S
Air Filter Primary.....	A-5549M
Air Filter Primary.....	A-5549
Air Filter Primary.....	A-5509
Air Filter Secondary.....	A-5510
Air Filter Set.....	A-5522-S
Fuel Filter Secondary.....	FC-5507
Hydraulic Oil Filter.....	H-5504
Oil Filter Full Flow.....	C-5510

Sakura Filter

ENGINE APPLICATION

MODEL/APPLICATION	SAKURA NO	MODEL/APPLICATION	SAKURA NO	MODEL/APPLICATION	SAKURA NO
CATERPILLAR		CATERPILLAR		CATERPILLAR	
D5 (DOZERS) w/3306 Eng. Hydraulic Oil Filter..... H-55320		Fuel Filter..... FC-5501 Oil Filter Full Flow..... C-5510		Hydraulic Oil Filter..... H-5504 Hydraulic Oil Filter..... H-5502 Hydraulic Oil Filter..... H-5508 Oil Filter Full Flow..... C-5510	
D550 (ARTICULATED TRUCKS) S/N: 4RD1-UP Air Filter Primary..... A-5521 Air Filter Set..... A-5521-S Air Filter Secondary..... A-5529 Air Filter Secondary..... A-5556 Air Filter Set..... A-5555-S Air Filter Primary..... A-5555 Fuel Filter..... FC-5509 Hydraulic Oil Filter..... H-5504 Hydraulic Oil Filter..... H-5503 Oil Filter Full Flow..... C-5516		D5B (DOZERS) CAT (S/N: 1AF978-992) Fuel Filter..... FC-5501 Oil Filter Full Flow..... C-5522 Oil Filter Full Flow..... C-5510		D5B (DOZERS) S/N: 24X1-UP Air Filter Primary..... A-5509 Air Filter Set..... A-5549M-S Air Filter Secondary..... A-5550 Air Filter Primary..... A-5549 Air Filter Primary..... A-5549M Air Filter Set..... A-5522-S Air Filter Secondary..... A-5510 Fuel Filter Secondary..... FC-5507 Hydraulic Oil Filter..... H-5508 Hydraulic Oil Filter..... H-5502 Hydraulic Oil Filter..... H-5504 Oil Filter Full Flow..... C-5510	
D550B (ARTICULATED TRUCKS) CAT 3408 (S/N: 5ND1-UP) , 2005-UP Air Filter Secondary..... A-5529 Air Filter Set..... A-5521-S Air Filter Primary..... A-5521 Fuel Filter..... F-5505 Hydraulic Oil Filter..... H-5503 Hydraulic Oil Filter..... H-5504 Oil Filter Full Flow..... C-5516		D5B (DOZERS) CAT (S/N: 7YJ1768-UP) Fuel Filter..... FC-5501 Fuel Filter Secondary..... FC-5507 Oil Filter Full Flow..... C-5505 Oil Filter Full Flow..... C-5519		D5B (DOZERS) S/N: 25X1-UP Air Filter Primary..... A-5509 Air Filter Secondary..... A-5510 Air Filter Set..... A-5522-S Air Filter Primary..... A-5549M Air Filter Primary..... A-5549 Air Filter Secondary..... A-5550 Air Filter Set..... A-5549M-S Fuel Filter Secondary..... FC-5507 Hydraulic Oil Filter..... H-5504 Hydraulic Oil Filter..... H-5502 Hydraulic Oil Filter..... H-5508 Oil Filter Full Flow..... C-5510	
D550B (ARTICULATED TRUCKS) S/N: 5ND1-UP Air Filter Primary..... A-5521 Air Filter Secondary..... A-5529 Air Filter Set..... A-5521-S Hydraulic Oil Filter..... H-55270 Hydraulic Oil Filter..... H-5526 Hydraulic Oil Filter..... H-55280 Hydraulic Oil Filter..... H-5504 Hydraulic Oil Filter..... H-5503 Oil Filter Full Flow..... C-5516		D5B (DOZERS) CAT S/N: 08Z19205-20403 Fuel Filter Secondary..... FC-5507		D5B (DOZERS) S/N: 26X1-826 Hydraulic Oil Filter..... H-5504 Hydraulic Oil Filter..... H-55270	
D5B (DOZERS) CAT (S/N: 08Z20404-UP) Fuel Filter Secondary..... FC-5507 Oil Filter Full Flow..... C-5522 Oil Filter Full Flow..... C-5510		D5B (DOZERS) CAT S/N: 13Z9002-UP Fuel Filter Secondary..... FC-5507		D5B (DOZERS) S/N: 26X1-UP Air Filter Set..... A-5549M-S Air Filter Secondary..... A-5550 Air Filter Primary..... A-5549 Air Filter Primary..... A-5549M Air Filter Set..... A-5522-S Air Filter Secondary..... A-5510 Air Filter Primary..... A-5509 Fuel Filter Secondary..... FC-5507 Hydraulic Oil Filter..... H-5504 Oil Filter Full Flow..... C-5510	
D5B (DOZERS) CAT (S/N: 08Z446-19204) Fuel Filter Secondary..... FC-5507 Oil Filter Full Flow..... C-5510 Oil Filter Full Flow..... C-5522		D5B (DOZERS) S/N: 21Y1-557 Hydraulic Oil Filter..... H-5504		D5B (DOZERS) S/N: 26X1-826 Hydraulic Oil Filter..... H-5504 Hydraulic Oil Filter..... H-55270	
D5B (DOZERS) CAT (S/N: 13Z1-7767) Fuel Filter..... FC-5501 Fuel Filter Secondary..... FC-5507 Oil Filter Full Flow..... C-5522 Oil Filter Full Flow..... C-5510		D5B (DOZERS) S/N: 21Y1-UP Air Filter Secondary..... A-5510 Air Filter Set..... A-5522-S Air Filter Primary..... A-5509 Fuel Filter Secondary..... FC-5507 Hydraulic Oil Filter..... H-5504		D5B (DOZERS) S/N: 26X1-UP Air Filter Set..... A-5549M-S Air Filter Secondary..... A-5550 Air Filter Primary..... A-5549 Air Filter Primary..... A-5549M Air Filter Set..... A-5522-S Air Filter Secondary..... A-5510 Air Filter Primary..... A-5509 Fuel Filter Secondary..... FC-5507 Hydraulic Oil Filter..... H-5504 Oil Filter Full Flow..... C-5510	
D5B (DOZERS) CAT (S/N: 13Z7768-9001) Fuel Filter..... FC-5501 Fuel Filter Secondary..... FC-5507		D5B (DOZERS) S/N: 22X1-UP Air Filter Primary..... A-5509 Air Filter Set..... A-5522-S Air Filter Secondary..... A-5510 Fuel Filter Secondary..... FC-5507 Hydraulic Oil Filter..... H-5508 Hydraulic Oil Filter..... H-5502 Hydraulic Oil Filter..... H-5504 Oil Filter Full Flow..... C-5510		D5B (DOZERS) S/N: 26X1-UP Hydraulic Oil Filter..... H-5504 Hydraulic Oil Filter..... H-55270	
D5B (DOZERS) CAT (S/N: 1AF1-977) Fuel Filter..... FC-5501 Fuel Filter Secondary..... FC-5507		D5B (DOZERS) S/N: 23X1-UP Air Filter Secondary..... A-5510 Air Filter Set..... A-5522-S Air Filter Primary..... A-5509 Fuel Filter Secondary..... FC-5507		D5B (DOZERS) S/N: 27Y1-UP Air Filter Secondary..... A-5510 Air Filter Set..... A-5522-S Air Filter Primary..... A-5549M Air Filter Primary..... A-5549	

Sakura Filter

ENGINE APPLICATION

MODEL/APPLICATION	SAKURA NO	MODEL/APPLICATION	SAKURA NO	MODEL/APPLICATION	SAKURA NO
CATERPILLAR		CATERPILLAR		CATERPILLAR	
D5B (DOZERS) S/N: 27Y1-UP		Air Filter.....	A-5546	Fuel Filter Secondary.....	FC-5507
Air Filter Secondary.....	A-5550	D5B (DOZERS) S/N: 47X1-UP		Hydraulic Oil Filter.....	H-5504
Air Filter Set.....	A-5549M-S	Air Filter Primary.....	A-5509	Hydraulic Oil Filter.....	H-55270
Air Filter Primary.....	A-5509	Air Filter Set.....	A-5522-S	Hydraulic Oil Filter.....	H-5502
Fuel Filter Secondary.....	FC-5507	Air Filter Secondary.....	A-5510	Hydraulic Oil Filter.....	H-5508
Hydraulic Oil Filter.....	H-5504	Fuel Filter Secondary.....	FC-5507	Oil Filter Full Flow.....	C-5510
Oil Filter Full Flow.....	C-5510	Hydraulic Oil Filter.....	H-5504	D5B (DOZERS) w/3306 Eng.	
D5B (DOZERS) S/N: 43X1-UP		Hydraulic Oil Filter.....	H-5508	Hydraulic Oil Filter.....	H-55320
Air Filter Primary.....	A-5509	Hydraulic Oil Filter.....	H-5502	D5C (DOZERS) CAT (S/N: 45V97770-UP)	
Air Filter Set.....	A-5522-S	Hydraulic Oil Filter.....	H-55270	Fuel Filter.....	FC-5501
Air Filter Secondary.....	A-5510	Oil Filter Full Flow.....	C-5510	Oil Filter Full Flow.....	C-5519
Fuel Filter Secondary.....	FC-5507	D5B (DOZERS) S/N: 48X1-UP		D5C (DOZERS) CAT (S/N: 7YJ1-1767)	
Hydraulic Oil Filter.....	H-5504	Air Filter Secondary.....	A-5510	Fuel Filter Secondary.....	FC-5507
Hydraulic Oil Filter.....	H-5502	Air Filter Set.....	A-5522-S	Fuel Filter.....	FC-5501
Hydraulic Oil Filter.....	H-5508	Air Filter Primary.....	A-5509	Oil Filter Full Flow.....	C-5519
Oil Filter Full Flow.....	C-5510	Fuel Filter Secondary.....	FC-5507	Oil Filter Full Flow.....	C-5505
D5B (DOZERS) S/N: 43X722-UP		Hydraulic Oil Filter.....	H-55270	D5C (DOZERS) S/N: 3MK1-UP	
Air Filter.....	A-5546	Hydraulic Oil Filter.....	H-5502	Air Filter Secondary.....	A-5525
D5B (DOZERS) S/N: 44X1111-UP		Hydraulic Oil Filter.....	H-5508	Air Filter Set.....	A-5542-S
Air Filter.....	A-5546	Hydraulic Oil Filter.....	H-5504	Air Filter Primary.....	A-5542
D5B (DOZERS) S/N: 44X1-UP		Oil Filter Full Flow.....	C-5510	Fuel Filter Secondary.....	FC-5507
Air Filter Primary.....	A-5509	D5B (DOZERS) S/N: 5LD1-UP		Hydraulic Oil Filter.....	H-5504
Air Filter Secondary.....	A-5510	Air Filter Set.....	A-5522-S	Hydraulic Oil Filter.....	H-55270
Air Filter Set.....	A-5522-S	Air Filter Secondary.....	A-5510	Oil Filter Full Flow.....	C-5519
Fuel Filter Secondary.....	FC-5507	Air Filter Primary.....	A-5509	D5C (DOZERS) S/N: 5SH1-UP	
Hydraulic Oil Filter.....	H-5508	Fuel Filter.....	F-5505	Air Filter Primary.....	A-5542
Hydraulic Oil Filter.....	H-5502	Fuel Filter Secondary.....	FC-5507	Air Filter Set.....	A-5542-S
Hydraulic Oil Filter.....	H-5504	Hydraulic Oil Filter.....	H-5504	Air Filter Secondary.....	A-5525
Oil Filter Full Flow.....	C-5510	Hydraulic Oil Filter.....	H-55270	Hydraulic Oil Filter.....	HC-5504
D5B (DOZERS) S/N: 45X1-UP		Hydraulic Oil Filter.....	H-5502	Oil Filter Full Flow.....	C-5504
Air Filter Set.....	A-5522-S	Hydraulic Oil Filter.....	H-5508	D5C (DOZERS) S/N: 6CS1-UP	
Air Filter Secondary.....	A-5510	Oil Filter Full Flow.....	C-5510	Air Filter Secondary.....	A-5525
Air Filter Primary.....	A-5509	D5B (DOZERS) S/N: 8HD1-620		Air Filter Set.....	A-5542-S
Fuel Filter Secondary.....	FC-5507	Air Filter Secondary.....	A-5510	Air Filter Primary.....	A-5542
Hydraulic Oil Filter.....	H-5504	Air Filter Set.....	A-5522-S	Hydraulic Oil Filter.....	HC-5504
Hydraulic Oil Filter.....	H-5502	Air Filter Primary.....	A-5509	Oil Filter Full Flow.....	C-5504
Hydraulic Oil Filter.....	H-5508	Fuel Filter.....	F-5505	D5C (DOZERS) S/N: 6PJ1-UP	
Oil Filter Full Flow.....	C-5510	Fuel Filter Secondary.....	FC-5507	Air Filter Secondary.....	A-5525
D5B (DOZERS) S/N: 45X422-UP		Hydraulic Oil Filter.....	H-55270	Air Filter Primary.....	A-5542
Air Filter.....	A-5546	Hydraulic Oil Filter.....	H-5502	Air Filter Set.....	A-5542-S
D5B (DOZERS) S/N: 46X1-UP		Hydraulic Oil Filter.....	H-5508	Air Filter Secondary.....	A-5525
Air Filter Primary.....	A-5509	Hydraulic Oil Filter.....	H-5504	Hydraulic Oil Filter.....	HC-5504
Air Filter Secondary.....	A-5510	Oil Filter Full Flow.....	C-5510	Oil Filter Full Flow.....	C-5504
Air Filter Set.....	A-5522-S	D5B (DOZERS) S/N: 8HD1-UP		D5C (DOZERS) S/N: 6ZL1-UP	
Fuel Filter Secondary.....	FC-5507	Air Filter Primary.....	A-5509	Air Filter Secondary.....	A-5525
Hydraulic Oil Filter.....	H-5504	Air Filter Set.....	A-5522-S	Air Filter Primary.....	A-5542
Hydraulic Oil Filter.....	H-5502	Air Filter Secondary.....	A-5510	Air Filter Secondary.....	A-5525
Oil Filter Full Flow.....	C-5510	Hydraulic Oil Filter.....	H-5508	Hydraulic Oil Filter.....	H-5504
D5B (DOZERS) S/N: 46X724-UP		Hydraulic Oil Filter.....	H-5502	D5C (DOZERS) S/N: 6ZL1-UP	
Air Filter Secondary.....	A-5510	Oil Filter Full Flow.....	C-5510	Air Filter Set.....	A-5542-S
Air Filter Set.....	A-5522-S	D5B (DOZERS) S/N: 8MB1-UP		Air Filter Primary.....	A-5542
Fuel Filter Secondary.....	FC-5507	Air Filter Secondary.....	A-5510	Air Filter Secondary.....	A-5525
Hydraulic Oil Filter.....	H-5504	Air Filter Set.....	A-5522-S	Hydraulic Oil Filter.....	H-5504
Oil Filter Full Flow.....	C-5510	Air Filter Primary.....	A-5509		

Sakura Filter

ENGINE APPLICATION

MODEL/APPLICATION	SAKURA NO	MODEL/APPLICATION	SAKURA NO	MODEL/APPLICATION	SAKURA NO
CATERPILLAR		CATERPILLAR		CATERPILLAR	
D5C (DOZERS) S/N: 6ZL1-UP		Air Filter Primary.....	A-5542	Oil Filter Full Flow.....	C-5504
Hydraulic Oil Filter.....	H-55270	Hydraulic Oil Filter.....	H-5504	D5E (DOZERS) CAT (S/N: 6NC2650-UP)	
Oil Filter Full Flow.....	C-5504	Hydraulic Oil Filter.....	H-55270	Fuel Filter Secondary.....	FC-5507
D5C (DOZERS) S/N: 7PS1-UP		Oil Filter Full Flow.....	C-5504	Oil Filter Full Flow.....	C-5510
Air Filter Primary.....	A-5542	D5C LGP XL SERIES III (DOZERS) S/N: 9DL1-UP		Oil Filter Full Flow.....	C-5522
Air Filter Set.....	A-5542-S	Air Filter Secondary.....	A-5525	D5E (DOZERS) CAT (S/N: 8TD3670-UP)	
Air Filter Secondary.....	A-5525	Air Filter Primary.....	A-5542	Fuel Filter Secondary.....	FC-5507
Hydraulic Oil Filter.....	HC-5504	Air Filter Set.....	A-5542-S	Oil Filter Full Flow.....	C-5522
Oil Filter Full Flow.....	C-5504	Hydraulic Oil Filter.....	H-55270	D5E (DOZERS) S/N: 7KJ1-UP	
D5C (DOZERS) S/N: 7YL1-UP		Hydraulic Oil Filter.....	H-5504	Air Filter Set.....	A-5522-S
Fuel Filter Secondary.....	FC-5507	Oil Filter Full Flow.....	C-5504	Air Filter Secondary.....	A-5510
Oil Filter Full Flow.....	C-5504	D5C SERIES III (DOZERS) S/N: 6CS1-UP		Air Filter Primary.....	A-5509
D5C (DOZERS) S/N: 8ZS1-UP		Air Filter Secondary.....	A-5525	Hydraulic Oil Filter.....	H-5508
Air Filter Set.....	A-5542-S	Air Filter Set.....	A-5542-S	Hydraulic Oil Filter.....	H-5502
Air Filter Primary.....	A-5542	Air Filter Primary.....	A-5542	D5E (DOZERS) S/N: 9RG1-353	
Air Filter Secondary.....	A-5525	Cabin Air Filter.....	CA-55070	Air Filter Secondary.....	A-5510
Hydraulic Oil Filter.....	H-55270	Hydraulic Oil Filter.....	HC-5504	Air Filter Set.....	A-5522-S
Hydraulic Oil Filter.....	H-5504	D5C SERIES III (DOZERS) S/N: 6ZL1-794		Air Filter Primary.....	A-5509
Oil Filter Full Flow.....	C-5504	Air Filter Primary.....	A-5542	Hydraulic Oil Filter.....	H-5508
D5C (DOZERS) S/N: 9DL1-UP		Air Filter Set.....	A-5542-S	Hydraulic Oil Filter.....	H-5504
Air Filter Primary.....	A-5542	Air Filter Secondary.....	A-5525	Hydraulic Oil Filter.....	H-5502
Air Filter Set.....	A-5542-S	Cabin Air Filter.....	CA-55070	Oil Filter Full Flow.....	C-5510
Air Filter Secondary.....	A-5525	Hydraulic Oil Filter.....	H-5501	D5E (DOZERS) S/N: 9RG1-UP	
Hydraulic Oil Filter.....	H-5504	Hydraulic Oil Filter.....	H-55270	Air Filter Primary.....	A-5509
Hydraulic Oil Filter.....	H-55270	D5C SERIES III (DOZERS) S/N: 6ZL795-UP		Air Filter Primary.....	A-5549M
Oil Filter Full Flow.....	C-5504	Air Filter Secondary.....	A-5525	Air Filter Primary.....	A-5549
D5C LGP XL SERIES III (DOZERS) S/N: 5HS1-UP		Air Filter Set.....	A-5542-S	Air Filter Secondary.....	A-5550
Air Filter Secondary.....	A-5525	Air Filter Primary.....	A-5542	Air Filter Set.....	A-5549M-S
Air Filter Primary.....	A-5542	Cabin Air Filter.....	CA-55070	Air Filter Set.....	A-5522-S
Air Filter Set.....	A-5542-S	Hydraulic Oil Filter.....	H-55270	Air Filter Secondary.....	A-5510
Hydraulic Oil Filter.....	H-55270	Hydraulic Oil Filter.....	H-5501	Fuel Filter Secondary.....	FC-5507
Hydraulic Oil Filter.....	H-5504	D5C SERIES III (DOZERS) S/N: 9DL1-2236		Fuel Filter.....	F-5505
Oil Filter Full Flow.....	C-5504	Air Filter Primary.....	A-5542	Hydraulic Oil Filter.....	H-55270
D5C LGP XL SERIES III (DOZERS) S/N: 6ZL1-UP		Air Filter Set.....	A-5542-S	Hydraulic Oil Filter.....	H-5504
Air Filter Secondary.....	A-5525	Air Filter Secondary.....	A-5525	Hydraulic Oil Filter.....	H-5508
Air Filter Set.....	A-5542-S	Cabin Air Filter.....	CA-55070	Hydraulic Oil Filter.....	H-5502
Air Filter Primary.....	A-5542	Hydraulic Oil Filter.....	H-5501	Oil Filter Full Flow.....	C-5510
Hydraulic Oil Filter.....	H-55270	Hydraulic Oil Filter.....	H-55270	D5E (DOZERS) S/N: 9RG354-UP	
Hydraulic Oil Filter.....	H-5504	D5C SERIES III (DOZERS) S/N: 9DL2237-UP		Air Filter Set.....	A-5549M-S
Oil Filter Full Flow.....	C-5504	Air Filter Secondary.....	A-5525	Air Filter Secondary.....	A-5550
D5C LGP XL SERIES III (DOZERS) S/N: 7PS1-UP		Air Filter Set.....	A-5542-S	Air Filter Primary.....	A-5549
Air Filter Secondary.....	A-5525	Air Filter Primary.....	A-5542	Air Filter Primary.....	A-5549M
Air Filter Primary.....	A-5542	Cabin Air Filter.....	CA-55070	Hydraulic Oil Filter.....	H-5504
Air Filter Set.....	A-5542-S	Hydraulic Oil Filter.....	H-55270	D5E (DOZERS) w/3306 Eng.	
Hydraulic Oil Filter.....	HC-5504	Hydraulic Oil Filter.....	H-5501	Hydraulic Oil Filter.....	H-55320
Oil Filter Full Flow.....	C-5504	D5C SERIES III (DOZERS) S/N: 9DL2550-2569		D5E DD (DOZERS) S/N: 9RG1-UP	
D5C LGP XL SERIES III (DOZERS) S/N: 8ZS1-UP		Air Filter Primary.....	A-5542	Air Filter Primary.....	A-5509
Air Filter Secondary.....	A-5525	Air Filter Set.....	A-5542-S	Air Filter Secondary.....	A-5510
Air Filter Primary.....	A-5542	Air Filter Secondary.....	A-5525	Air Filter Set.....	A-5522-S
Air Filter Set.....	A-5542-S	Hydraulic Oil Filter.....	H-5504	Fuel Filter Secondary.....	FC-5507
Hydraulic Oil Filter.....	HC-5504	Hydraulic Oil Filter.....	H-55270	Hydraulic Oil Filter.....	H-5508
Oil Filter Full Flow.....	C-5504	Hydraulic Oil Filter.....	H-5501		
D5C LGP XL SERIES III (DOZERS) S/N: 8ZS1-UP		D5C SERIES III (DOZERS) S/N: 9DL2550-2569			
Air Filter Secondary.....	A-5525	Air Filter Primary.....	A-5542		
Air Filter Set.....	A-5542-S	Air Filter Set.....	A-5542-S		
Hydraulic Oil Filter.....	HC-5504	Air Filter Secondary.....	A-5525		
Oil Filter Full Flow.....	C-5504	Hydraulic Oil Filter.....	H-5504		
D5C LGP XL SERIES III (DOZERS) S/N: 8ZS1-UP		Hydraulic Oil Filter.....	H-55270		
Air Filter Secondary.....	A-5525	Hydraulic Oil Filter.....	H-5501		
Air Filter Set.....	A-5542-S				
Hydraulic Oil Filter.....	HC-5504				
Oil Filter Full Flow.....	C-5504				

MODEL/APPLICATION	SAKURA NO
CATERPILLAR	
D5E DD (DOZERS) S/N: 9RG1-UP	
Hydraulic Oil Filter.....	H-5502
Hydraulic Oil Filter.....	H-5504
Oil Filter Full Flow.....	C-5510
D5G (DOZERS) CAT (S/N: 5XK30700-UP)	
Fuel Filter.....	FC-5516
Fuel Filter Secondary.....	FC-5515
Fuel Filter Secondary.....	FC-55151
Oil Filter Full Flow.....	C-5504
D5G (DOZERS) CAT (S/N: MHK1-UP)	
Fuel Filter Secondary.....	FC-55151
Fuel Filter Secondary.....	FC-5515
Fuel Filter.....	FC-5516
Oil Filter Full Flow.....	C-5504
D5G (DOZERS) CAT 3046 T	
Air Filter Secondary.....	A-4402
Oil Filter Full Flow.....	C-6218
D5G (DOZERS) S/N: FDH1-UP	
Hydraulic Oil Filter.....	HC-5504
Hydraulic Oil Filter.....	HC-5507
Hydraulic Oil Filter.....	HC-55220
D5G (DOZERS) S/N: FDW1-UP	
Hydraulic Oil Filter.....	HC-55220
Hydraulic Oil Filter.....	HC-5507
Hydraulic Oil Filter.....	HC-5504
D5G (DOZERS) S/N: RKG1-UP	
Hydraulic Oil Filter.....	HC-5504
Hydraulic Oil Filter.....	HC-5507
Hydraulic Oil Filter.....	HC-55220
D5 G XL (DOZERS) CAT 3046 T TIER2	
Air Filter Secondary.....	A-4402
D5H (DOZERS) CAT 3304	
Cabin Air Filter.....	CA-55140
D5H (DOZERS) CAT (S/N: 12Z10967-38999)	
Oil Filter Full Flow.....	C-5510
D5H (DOZERS) CAT (S/N: 12Z39000-46243)	
Fuel Filter.....	FC-5501
Fuel Filter Secondary.....	FC-5507
Oil Filter Full Flow.....	C-5510

MODEL/APPLICATION	SAKURA NO
CATERPILLAR	
D5H (DOZERS) CAT (S/N: 12Z46244-UP)	
Fuel Filter Secondary.....	FC-5507
Oil Filter Full Flow.....	C-5510
D5H (DOZERS) S/N: 1DD1-3999	
Air Filter Primary.....	A-5509
Air Filter Set.....	A-5522-S
Air Filter Secondary.....	A-5522
Fuel Filter.....	F-5505
Fuel Filter Secondary.....	FC-5507
Hydraulic Oil Filter.....	H-55270
Hydraulic Oil Filter.....	H-5504
Oil Filter Full Flow.....	C-5510
D5H (DOZERS) S/N: 1DD1-5759	
Air Filter Secondary.....	A-5522
Air Filter Set.....	A-5522-S
Air Filter Primary.....	A-5509
Hydraulic Oil Filter.....	H-5510
Hydraulic Oil Filter.....	H-5504
D5H (DOZERS) S/N: 1DD4000-UP	
Air Filter Set.....	A-5549M-S
Air Filter Secondary.....	A-5550
Air Filter Primary.....	A-5549
Air Filter Primary.....	A-5549M
Fuel Filter Secondary.....	FC-5507
Fuel Filter.....	F-5505
Hydraulic Oil Filter.....	H-5504
Hydraulic Oil Filter.....	H-55270
Oil Filter Full Flow.....	C-5510
D5H (DOZERS) S/N: 1DD5760-UP	
Air Filter Primary.....	A-5549M
Air Filter Primary.....	A-5549
Air Filter Secondary.....	A-5550
Air Filter Set.....	A-5549M-S
Hydraulic Oil Filter.....	H-5504
Hydraulic Oil Filter.....	H-5510
D5H (DOZERS) S/N: 1TD4027-UP	
Air Filter Primary.....	A-5509
Air Filter Set.....	A-5522-S
Air Filter Secondary.....	A-5522
Fuel Filter.....	F-5505
Fuel Filter Secondary.....	FC-5507
Hydraulic Oil Filter.....	H-55270
Hydraulic Oil Filter.....	H-5510
Hydraulic Oil Filter.....	H-5504
D5H (DOZERS) S/N: 1WB1-UP	
Hydraulic Oil Filter.....	H-5501
D5H (DOZERS) S/N: 1YD1-4026	
Air Filter Secondary.....	A-5522
Air Filter Set.....	A-5522-S

MODEL/APPLICATION	SAKURA NO
CATERPILLAR	
Air Filter Primary.....	A-5509
Fuel Filter.....	F-5505
Fuel Filter Secondary.....	FC-5507
Hydraulic Oil Filter.....	H-5504
Hydraulic Oil Filter.....	H-5510
Hydraulic Oil Filter.....	H-55270
D5H (DOZERS) S/N: 1YD1-UP	
Air Filter Set.....	A-5549M-S
Air Filter Secondary.....	A-5550
Air Filter Primary.....	A-5549
Air Filter Primary.....	A-5549M
Air Filter Primary.....	A-5509
Air Filter Set.....	A-5522-S
Air Filter Secondary.....	A-5522
Fuel Filter Secondary.....	FC-5507
Hydraulic Oil Filter.....	H-5504
Hydraulic Oil Filter.....	H-5510
Oil Filter Full Flow.....	C-5510
D5H (DOZERS) S/N: 2CC1-UP	
Hydraulic Oil Filter.....	H-5501
D5H (DOZERS) S/N: 2EJ1-UP	
Hydraulic Oil Filter.....	H-5501
D5H (DOZERS) S/N: 2SD1-4078	
Air Filter Secondary.....	A-5522
Air Filter Set.....	A-5522-S
Air Filter Primary.....	A-5509
Fuel Filter.....	F-5505
Fuel Filter Secondary.....	FC-5507
Hydraulic Oil Filter.....	H-55270
Hydraulic Oil Filter.....	H-5504
Hydraulic Oil Filter.....	H-5510
D5H (DOZERS) S/N: 2SD1-UP	
Air Filter Primary.....	A-5549M
Air Filter Primary.....	A-5549
Air Filter Secondary.....	A-5550
Air Filter Set.....	A-5549M-S
Air Filter Primary.....	A-5509
Air Filter Set.....	A-5522-S
Air Filter Secondary.....	A-5522
Fuel Filter Secondary.....	FC-5507
Hydraulic Oil Filter.....	H-5510
Hydraulic Oil Filter.....	H-5504
Oil Filter Full Flow.....	C-5510
D5H (DOZERS) S/N: 2SD4079-UP	
Air Filter Secondary.....	A-5522
Air Filter Set.....	A-5522-S
Air Filter Primary.....	A-5509
Fuel Filter.....	F-5505
Fuel Filter Secondary.....	FC-5507
Hydraulic Oil Filter.....	H-55270
Hydraulic Oil Filter.....	H-5504
Hydraulic Oil Filter.....	H-5510

Sakura Filter

ENGINE APPLICATION

MODEL/APPLICATION	SAKURA NO	MODEL/APPLICATION	SAKURA NO	MODEL/APPLICATION	SAKURA NO
CATERPILLAR		CATERPILLAR		CATERPILLAR	
DSH (DOZERS) S/N: 3MD1-4025 Air Filter Primary..... A-5509 Air Filter Set..... A-5522-S Air Filter Secondary..... A-5522 Fuel Filter Secondary..... FC-5507 Fuel Filter..... F-5505 Hydraulic Oil Filter..... H-5510 Hydraulic Oil Filter..... H-5504 Hydraulic Oil Filter..... H-55270		Hydraulic Oil Filter..... H-5504 Hydraulic Oil Filter..... H-5510 Oil Filter Full Flow..... C-5510 DSH (DOZERS) S/N: 4KD4070-UP Air Filter Primary..... A-5509 Air Filter Set..... A-5522-S Air Filter Secondary..... A-5522 Fuel Filter Secondary..... FC-5507 Fuel Filter..... F-5505 Hydraulic Oil Filter..... H-55270 Hydraulic Oil Filter..... H-5510 Hydraulic Oil Filter..... H-5504		Air Filter Secondary..... A-5522 Hydraulic Oil Filter..... H-5510 Hydraulic Oil Filter..... H-55270 Hydraulic Oil Filter..... H-5504 DSH (DOZERS) S/N: 7NC5525-UP Air Filter Primary..... A-5549M Air Filter Primary..... A-5549 Air Filter Secondary..... A-5550 Air Filter Set..... A-5549M-S Hydraulic Oil Filter..... H-5510 Hydraulic Oil Filter..... H-5504 Hydraulic Oil Filter..... H-55270	
DSH (DOZERS) S/N: 3MD1-4026 Air Filter Set..... A-5549M-S Air Filter Secondary..... A-5550 Air Filter Primary..... A-5549 Air Filter Primary..... A-5549M Air Filter Secondary..... A-5522 Air Filter Set..... A-5522-S Air Filter Primary..... A-5509 Fuel Filter Secondary..... FC-5507 Hydraulic Oil Filter..... H-5504 Hydraulic Oil Filter..... H-5510 Oil Filter Full Flow..... C-5510		DSH (DOZERS) S/N: 4KD4071-UP Air Filter Secondary..... A-5522 Air Filter Set..... A-5522-S Air Filter Primary..... A-5509 Air Filter Primary..... A-5549M Air Filter Primary..... A-5549 Air Filter Secondary..... A-5550 Air Filter Set..... A-5549M-S Fuel Filter Secondary..... FC-5507 Hydraulic Oil Filter..... H-5504 Hydraulic Oil Filter..... H-5510 Oil Filter Full Flow..... C-5510		DSH (DOZERS) S/N: 8RC1-3999 Air Filter Secondary..... A-5522 Air Filter Set..... A-5522-S Air Filter Primary..... A-5509 Fuel Filter..... F-5505 Fuel Filter Secondary..... FC-5507 Hydraulic Oil Filter..... H-5504 Hydraulic Oil Filter..... H-55270 Oil Filter Full Flow..... C-5510	
DSH (DOZERS) S/N: 3MD4026-UP Air Filter Primary..... A-5509 Air Filter Set..... A-5522-S Air Filter Secondary..... A-5522 Fuel Filter..... F-5505 Fuel Filter Secondary..... FC-5507 Hydraulic Oil Filter..... H-55270 Hydraulic Oil Filter..... H-5510 Hydraulic Oil Filter..... H-5504		DSH (DOZERS) S/N: 7NC1-3999 Air Filter Primary..... A-5509 Air Filter Set..... A-5522-S Air Filter Secondary..... A-5522 Fuel Filter Secondary..... FC-5507 Fuel Filter..... F-5505 Hydraulic Oil Filter..... H-55270 Hydraulic Oil Filter..... H-5504 Oil Filter Full Flow..... C-5510		DSH (DOZERS) S/N: 8RC1-5846 Air Filter Primary..... A-5509 Air Filter Set..... A-5522-S Air Filter Secondary..... A-5522 Hydraulic Oil Filter..... H-5504 Hydraulic Oil Filter..... H-5510	
DSH (DOZERS) S/N: 3MD4027-UP Air Filter Secondary..... A-5522 Air Filter Set..... A-5522-S Air Filter Primary..... A-5509 Fuel Filter Secondary..... FC-5507 Hydraulic Oil Filter..... H-5504 Hydraulic Oil Filter..... H-5510 Oil Filter Full Flow..... C-5510		DSH (DOZERS) S/N: 7NC1-5499 Air Filter Secondary..... A-5522 Air Filter Set..... A-5522-S Air Filter Primary..... A-5509 Hydraulic Oil Filter..... H-5510 Hydraulic Oil Filter..... H-55270 Hydraulic Oil Filter..... H-5504		DSH (DOZERS) S/N: 8RC4000-UP Air Filter Set..... A-5549M-S Air Filter Secondary..... A-5550 Air Filter Primary..... A-5549 Air Filter Primary..... A-5549M Fuel Filter Secondary..... FC-5507 Fuel Filter..... F-5505 Hydraulic Oil Filter..... H-55270 Hydraulic Oil Filter..... H-5504 Oil Filter Full Flow..... C-5510	
DSH (DOZERS) S/N: 4KD1-4069 Air Filter Primary..... A-5509 Air Filter Set..... A-5522-S Air Filter Secondary..... A-5522 Fuel Filter Secondary..... FC-5507 Fuel Filter..... F-5505 Hydraulic Oil Filter..... H-55270 Hydraulic Oil Filter..... H-5510 Hydraulic Oil Filter..... H-5504		DSH (DOZERS) S/N: 7NC4000-UP Air Filter Set..... A-5549M-S Air Filter Secondary..... A-5550 Air Filter Primary..... A-5549 Air Filter Primary..... A-5549M Fuel Filter Secondary..... FC-5507 Fuel Filter..... F-5505 Hydraulic Oil Filter..... H-5504 Hydraulic Oil Filter..... H-55270 Hydraulic Oil Filter..... H-5510		DSH (DOZERS) S/N: 8RC5847-UP Air Filter Primary..... A-5549M Air Filter Primary..... A-5549 Air Filter Secondary..... A-5550 Air Filter Set..... A-5549M-S Hydraulic Oil Filter..... H-5504 Hydraulic Oil Filter..... H-5510	
DSH (DOZERS) S/N: 4KD1-4070 Air Filter Secondary..... A-5522 Air Filter Set..... A-5522-S Air Filter Primary..... A-5509 Fuel Filter Secondary..... FC-5507		DSH (DOZERS) S/N: 7NC5500-5524 Air Filter Primary..... A-5509 Air Filter Set..... A-5522-S		DSH (DOZERS) S/N: 8SC1-UP Air Filter Secondary..... A-5522 Air Filter Set..... A-5522-S Air Filter Primary..... A-5509 Fuel Filter Secondary..... FC-5507 Fuel Filter..... F-5505 Oil Filter Full Flow..... C-5510	

MODEL/APPLICATION	SAKURA NO	MODEL/APPLICATION	SAKURA NO	MODEL/APPLICATION	SAKURA NO
CATERPILLAR		CATERPILLAR		CATERPILLAR	
D5H (DOZERS) S/N: 9HC1-3999 Air Filter Primary..... A-5509 Air Filter Set..... A-5522-S Air Filter Secondary..... A-5522 Fuel Filter..... F-5505 Fuel Filter Secondary..... FC-5507 Hydraulic Oil Filter..... H-55270 Hydraulic Oil Filter..... H-5504 Oil Filter Full Flow..... C-5510		D5H II (DOZERS) CAT 3304 Cabin Air Filter..... CA-55140 D5H LGP (DOZERS) S/N: 3MD1-UP , T0-2001 Air Filter Secondary..... A-5522 Air Filter Set..... A-5522-S Air Filter Primary..... A-5509 Fuel Filter..... F-5505 Fuel Filter Secondary..... FC-5507 Hydraulic Oil Filter..... H-5504 Hydraulic Oil Filter..... H-5510 Hydraulic Oil Filter..... H-55270 D5H LGP (DOZERS) CAT 3304 Cabin Air Filter..... CA-55140 D5H LGP (DOZERS) S/N: 1DD1-3999 Air Filter Set..... A-5522-S Air Filter Primary..... A-5509 Air Filter Secondary..... A-5522 Fuel Filter Secondary..... FC-5507 Fuel Filter..... F-5505 Hydraulic Oil Filter..... H-55270 Hydraulic Oil Filter..... H-5504 Oil Filter Full Flow..... C-5510 D5H LGP (DOZERS) S/N: 1YD1-UP Air Filter Secondary..... A-5522 Air Filter Primary..... A-5509 Air Filter Set..... A-5522-S Fuel Filter..... F-5505 Fuel Filter Secondary..... FC-5507 Hydraulic Oil Filter..... H-5504 Hydraulic Oil Filter..... H-55270 Hydraulic Oil Filter..... H-5510 D5H LGP (DOZERS) S/N: 2SD1-UP Air Filter Secondary..... A-5522 Air Filter Set..... A-5522-S Air Filter Primary..... A-5509 Fuel Filter Secondary..... FC-5507 Fuel Filter..... F-5505 Hydraulic Oil Filter..... H-5510 Hydraulic Oil Filter..... H-5504 D5H LGP (DOZERS) S/N: 4KD1-UP Air Filter Primary..... A-5509 Air Filter Set..... A-5522-S Air Filter Secondary..... A-5522 Fuel Filter..... F-5505 Fuel Filter Secondary..... FC-5507 Hydraulic Oil Filter..... H-5504 Hydraulic Oil Filter..... H-5510 Hydraulic Oil Filter..... H-55270 D5H LGP (DOZERS) S/N: 7NC1-3999		Air Filter Secondary..... A-5509 Air Filter Set..... A-5522-S Air Filter Primary..... A-5509 Fuel Filter..... F-5505 Fuel Filter Secondary..... FC-5507 Hydraulic Oil Filter..... H-5504 Hydraulic Oil Filter..... H-55270 Oil Filter Full Flow..... C-5510 D5H LGP (DOZERS) S/N: 8SC1-UP Air Filter Secondary..... A-5522 Air Filter Set..... A-5522-S Air Filter Primary..... A-5509 Fuel Filter..... F-5505 Fuel Filter Secondary..... FC-5507 Oil Filter Full Flow..... C-5510 D5H LGP (DOZERS) S/N: 9HC1-3999 Air Filter Primary..... A-5509 Air Filter Set..... A-5522-S Air Filter Secondary..... A-5522 Fuel Filter Secondary..... FC-5507 Fuel Filter..... F-5505 Hydraulic Oil Filter..... H-5504 Hydraulic Oil Filter..... H-55270 Oil Filter Full Flow..... C-5510 D5H LGP SERIES II (DOZERS) S/N: 1DD4000-UP Air Filter Primary..... A-5509 Air Filter Secondary..... A-5522 Air Filter Set..... A-5522-S Fuel Filter..... F-5505 Fuel Filter Secondary..... FC-5507 Hydraulic Oil Filter..... H-5504 Hydraulic Oil Filter..... H-55270 Oil Filter Full Flow..... C-5510 D5H LGP SERIES II (DOZERS) S/N: 2SD4079-UP Air Filter Primary..... A-5509 Air Filter Set..... A-5522-S Air Filter Secondary..... A-5522 Fuel Filter Secondary..... FC-5507 Fuel Filter..... F-5505 Hydraulic Oil Filter..... H-5510 Hydraulic Oil Filter..... H-55270 Hydraulic Oil Filter..... H-5504 D5H LGP SERIES II (DOZERS) S/N: 3MD4026-UP Air Filter Primary..... A-5509	
D5H (DOZERS) S/N: 9HC1-5499 Air Filter Secondary..... A-5522 Air Filter Set..... A-5522-S Air Filter Primary..... A-5509 Hydraulic Oil Filter..... H-5510 Hydraulic Oil Filter..... H-5504 Hydraulic Oil Filter..... H-55270		D5H (DOZERS) S/N: 9HC1-UP Air Filter Set..... A-5549M-S Air Filter Secondary..... A-5550 Air Filter Primary..... A-5549 Air Filter Primary..... A-5549M Air Filter Primary..... A-5509 Air Filter Set..... A-5522-S Air Filter Secondary..... A-5522 Fuel Filter Secondary..... FC-5507 Hydraulic Oil Filter..... H-5504 Oil Filter Full Flow..... C-5510		D5H (DOZERS) S/N: 9HC4000-UP Air Filter Primary..... A-5549M Air Filter Primary..... A-5549 Air Filter Secondary..... A-5550 Air Filter Set..... A-5549M-S Fuel Filter..... F-5505 Fuel Filter Secondary..... FC-5507 Hydraulic Oil Filter..... H-55270 Hydraulic Oil Filter..... H-5504 Oil Filter Full Flow..... C-5510	
D5H (DOZERS) S/N: 9HC5500-5518 Air Filter Secondary..... A-5522 Air Filter Set..... A-5522-S Air Filter Primary..... A-5509 Hydraulic Oil Filter..... H-55270 Hydraulic Oil Filter..... H-5504 Hydraulic Oil Filter..... H-5510		D5H (DOZERS) S/N: 9HC5519-UP Air Filter Set..... A-5549M-S Air Filter Secondary..... A-5550 Air Filter Primary..... A-5549 Air Filter Primary..... A-5549M Hydraulic Oil Filter..... H-5504 Hydraulic Oil Filter..... H-55270 Hydraulic Oil Filter..... H-5510			

MODEL/APPLICATION	SAKURA NO	MODEL/APPLICATION	SAKURA NO	MODEL/APPLICATION	SAKURA NO
CATERPILLAR		CATERPILLAR		CATERPILLAR	
D5H LGP SERIES II (DOZERS) S/N: 3MD4026-UP		Hydraulic Oil Filter.....	H-5510	Hydraulic Oil Filter.....	H-5510
Air Filter Secondary.....	A-5522	D5H SERIES II (DOZERS) S/N: 2EJ1-UP		Oil Filter Full Flow.....	C-5510
Air Filter Set.....	A-5522-S	Hydraulic Oil Filter.....	H-5501	D5H XL (DOZERS) CAT 3304	
Fuel Filter.....	F-5505	D5H SERIES II (DOZERS) S/N: 8RC1-5846		Cabin Air Filter.....	CA-55140
Fuel Filter Secondary.....	FC-5507	Air Filter Primary.....	A-5509	D5H XL (DOZERS) S/N: 8RJ1-UP	
Hydraulic Oil Filter.....	H-5504	Air Filter Set.....	A-5522-S	Air Filter Primary.....	A-5549M
Hydraulic Oil Filter.....	H-55270	Air Filter Secondary.....	A-5522	Air Filter Primary.....	A-5549
Hydraulic Oil Filter.....	H-5510	Hydraulic Oil Filter.....	H-5504	Air Filter Secondary.....	A-5550
D5H LGP SERIES II (DOZERS) S/N: 4KD4070-UP		Hydraulic Oil Filter.....	H-5510	Air Filter Set.....	A-5549M-S
Air Filter Primary.....	A-5549	D5H SERIES II (DOZERS) S/N: 8RC5847-UP		Fuel Filter.....	F-5505
Air Filter Primary.....	A-5549M	Air Filter Set.....	A-5549M-S	Fuel Filter Secondary.....	FC-5507
Air Filter Secondary.....	A-5550	Air Filter Primary.....	A-5549	Hydraulic Oil Filter.....	H-55270
Air Filter Set.....	A-5549M-S	Air Filter Secondary.....	A-5550	Hydraulic Oil Filter.....	H-5504
Fuel Filter Secondary.....	FC-5507	Air Filter Primary.....	A-5549M	Oil Filter Full Flow.....	C-5510
Fuel Filter.....	F-5505	Hydraulic Oil Filter.....	H-5504	D5K (DOZERS) CAT S/N: C4E50-UP , 2005-UP	
Hydraulic Oil Filter.....	H-55270	Hydraulic Oil Filter.....	H-5510	Oil Filter Full Flow.....	C-5102
Hydraulic Oil Filter.....	H-5504	D5H SERIES II (DOZERS) S/N: 8RJ1-UP		D5K (DOZERS) CAT S/N: JLF1-UP , 2005-UP	
Oil Filter Full Flow.....	C-5510	Air Filter Primary.....	A-5549M	Oil Filter Full Flow.....	C-5102
D5H LGP SERIES II (DOZERS) S/N: 9HC4000-UP		Air Filter Secondary.....	A-5550	D5K (DOZERS) CAT S/N: WMM1-UP , 2005-UP	
Air Filter Primary.....	A-5549M	Air Filter Primary.....	A-5549	Oil Filter Full Flow.....	C-5102
Air Filter Primary.....	A-5549	Air Filter Set.....	A-5549M-S	D5K (DOZERS) CAT S/N: YYY1-UP , 2005-UP	
Air Filter Set.....	A-5549M-S	Hydraulic Oil Filter.....	H-5510	Oil Filter Full Flow.....	C-5102
Air Filter Secondary.....	A-5550	Hydraulic Oil Filter.....	H-5504	D5K (DOZERS) CAT S/N: C4E1-49-UP , 2004-UP	
Fuel Filter.....	F-5505	Hydraulic Oil Filter.....	H-55270	Oil Filter Full Flow.....	C-5102
Fuel Filter Secondary.....	FC-5507	D5H SERIES II (DOZERS) S/N: 9HC1-5499		D5K (DOZERS) CAT S/N: JLF1-UP , 2004-UP	
Hydraulic Oil Filter.....	H-5504	Air Filter Secondary.....	A-5522	Oil Filter Full Flow.....	C-5102
Hydraulic Oil Filter.....	H-55270	Air Filter Set.....	A-5522-S	D5K (DOZERS) CAT S/N: WMM1-UP , 2004-UP	
Oil Filter Full Flow.....	C-5510	Air Filter Primary.....	A-5509	Oil Filter Full Flow.....	C-5102
D5H SERIES II (DOZERS) CAT (S/N: 12Z10967-38999)		Hydraulic Oil Filter.....	H-5510	D5K (DOZERS) CAT S/N: YYY1-UP , 2004-UP	
Oil Filter Full Flow.....	C-5510	Hydraulic Oil Filter.....	H-5504	Oil Filter Full Flow.....	C-5102
D5H SERIES II (DOZERS) CAT (S/N: 12Z39000-46243)		Hydraulic Oil Filter.....	H-55270	D5K (DOZERS) CAT S/N: WMM1-UP , 2004-UP	
Fuel Filter Secondary.....	FC-5507	D5H SERIES II (DOZERS) S/N: 9HC5500-5518		Oil Filter Full Flow.....	C-5102
Fuel Filter.....	FC-5501	Air Filter Set.....	A-5522-S	D5K (DOZERS) CAT S/N: YYY1-UP , 2004-UP	
Oil Filter Full Flow.....	C-5510	Air Filter Secondary.....	A-5522	Oil Filter Full Flow.....	C-5102
D5H SERIES II (DOZERS) CAT (S/N: 12Z46244-UP)		Air Filter Primary.....	A-5509	D5K (DOZERS) CAT S/N: YYY1-UP , 2004-UP	
Fuel Filter Secondary.....	FC-5507	Hydraulic Oil Filter.....	H-55270	Oil Filter Full Flow.....	C-5102
Oil Filter Full Flow.....	C-5510	Hydraulic Oil Filter.....	H-5504	D5M (DOZERS) CAT (S/N: 4TF23390-28928)	
D5H SERIES II (DOZERS) S/N: 1DD1-5759		Hydraulic Oil Filter.....	H-5510	Fuel Filter.....	FC-5508
Air Filter Primary.....	A-5509	D5H SERIES II (DOZERS) S/N: 9HC5519-UP		Oil Filter Full Flow.....	C-5522
Air Filter Secondary.....	A-5522	Air Filter Primary.....	A-5549M	D5M (DOZERS) CAT (S/N: 4TF28929-29016)	
Air Filter Set.....	A-5522-S	Air Filter Set.....	A-5549M-S	Fuel Filter.....	FC-5508
Hydraulic Oil Filter.....	H-5504	Air Filter Primary.....	A-5549	Fuel Filter Secondary.....	FC-55151
Hydraulic Oil Filter.....	H-5510	Air Filter Secondary.....	A-5550	Fuel Filter Secondary.....	FC-5515
D5H SERIES II (DOZERS) S/N: 1DD5760-UP		Hydraulic Oil Filter.....	H-5504	Fuel Filter.....	FC-5516
Air Filter Set.....	A-5549M-S	Hydraulic Oil Filter.....	H-55270	Oil Filter Full Flow.....	C-5522
Air Filter Secondary.....	A-5550	D5H TSK (SKIDDERS) S/N: 7EG1-UP		D5M (DOZERS) CAT (S/N: 4TF29017-UP)	
Air Filter Primary.....	A-5549	Air Filter Primary.....	A-5509	Fuel Filter.....	FC-5516
Air Filter Primary.....	A-5549M	Air Filter Set.....	A-5522-S	Fuel Filter Secondary.....	FC-5515
Hydraulic Oil Filter.....	H-5504	Air Filter Secondary.....	A-5522	D5M (DOZERS) CAT (S/N: 4TF29017-UP)	
D5H SERIES II (DOZERS) S/N: 1DD5760-UP		Fuel Filter.....	F-5505	Fuel Filter.....	FC-5516
Air Filter Set.....	A-5549M-S	D5H TSK (SKIDDERS) S/N: 7EG1-UP		Fuel Filter Secondary.....	FC-5515
Air Filter Secondary.....	A-5550	Air Filter Primary.....	A-5509	D5M (DOZERS) CAT (S/N: 4TF29017-UP)	
Air Filter Primary.....	A-5549	Air Filter Set.....	A-5522-S	Fuel Filter.....	FC-5516
Air Filter Primary.....	A-5549M	Air Filter Secondary.....	A-5522	Fuel Filter Secondary.....	FC-5515
Hydraulic Oil Filter.....	H-5504	Fuel Filter.....	F-5505		

MODEL/APPLICATION	SAKURA NO	MODEL/APPLICATION	SAKURA NO	MODEL/APPLICATION	SAKURA NO
CATERPILLAR		CATERPILLAR		CATERPILLAR	
DSM (DOZERS) CAT (S/N: 4TF29017-UP) Fuel Filter Secondary..... FC-55151 Oil Filter Full Flow..... C-5522		Fuel Filter..... FC-5516 Fuel Filter Secondary..... FC-5515 Fuel Filter..... FC-5508 Fuel Filter Secondary..... FC-55151 Hydraulic Oil Filter..... H-5526 Hydraulic Oil Filter..... H-55270 Hydraulic Oil Filter..... H-5504 Oil Filter Full Flow..... C-5510		DSM LGP (DOZERS) CAT 3116 Cabin Air Filter..... CA-55140	
DSM (DOZERS) S/N: 3CR1033-UP Air Filter Secondary..... A-5567 Air Filter Set..... A-5568-S Air Filter Primary..... A-5566 Hydraulic Oil Filter..... H-5504 Hydraulic Oil Filter..... H-55270 Hydraulic Oil Filter..... H-5526 Hydraulic Oil Filter..... H-55280		DSM (DOZERS) S/N: 4BR533-UP Air Filter Primary..... A-5566 Air Filter Set..... A-5568-S Air Filter Secondary..... A-5567 Hydraulic Oil Filter..... H-5504 Hydraulic Oil Filter..... H-55270 Hydraulic Oil Filter..... H-5526 Hydraulic Oil Filter..... H-55280		DSM LGP (DOZERS) S/N: 4JS1-UP Air Filter Set..... A-5568-S Air Filter Secondary..... A-5567 Air Filter Primary..... A-5566 Fuel Filter Secondary..... FC-5515 Fuel Filter Secondary..... FC-55151 Fuel Filter..... FC-5516 Hydraulic Oil Filter..... H-55270 Hydraulic Oil Filter..... H-5504 Hydraulic Oil Filter..... HC-55220 Hydraulic Oil Filter..... HC-5507 Oil Filter Full Flow..... C-5510	
DSM (DOZERS) S/N: 3CR1-1032 Air Filter Set..... A-5568-S Air Filter Secondary..... A-5567 Air Filter Primary..... A-5566 Hydraulic Oil Filter..... H-55270		DSM (DOZERS) S/N: 6DR1-UP Air Filter Secondary..... A-5567 Air Filter Set..... A-5568-S Air Filter Primary..... A-5566 Fuel Filter Secondary..... FC-55151 Fuel Filter..... FC-5508 Fuel Filter Secondary..... FC-5515 Fuel Filter..... FC-5516 Hydraulic Oil Filter..... H-5526 Hydraulic Oil Filter..... H-55270 Hydraulic Oil Filter..... H-5504 Oil Filter Full Flow..... C-5510		DSM LGP (DOZERS) S/N: 5ES1-UP Air Filter Set..... A-5568-S Air Filter Primary..... A-5566 Air Filter Secondary..... A-5567 Fuel Filter..... FC-5516 Fuel Filter Secondary..... FC-55151 Fuel Filter Secondary..... FC-5515 Hydraulic Oil Filter..... H-5001 Hydraulic Oil Filter..... H-55270 Hydraulic Oil Filter..... H-5526 Hydraulic Oil Filter..... H-5504 Oil Filter Full Flow..... C-5510	
DSM (DOZERS) S/N: 3CR1-UP Air Filter Secondary..... A-5567 Air Filter Set..... A-5568-S Air Filter Primary..... A-5566 Fuel Filter Secondary..... FC-55151 Fuel Filter..... FC-5508 Fuel Filter Secondary..... FC-5515 Fuel Filter..... FC-5516 Hydraulic Oil Filter..... H-55270 Hydraulic Oil Filter..... H-5504 Hydraulic Oil Filter..... H-5526 Oil Filter Full Flow..... C-5510		DSM (DOZERS) S/N: 6GN1-1334 Air Filter Primary..... A-5566 Air Filter Set..... A-5568-S Air Filter Secondary..... A-5567 Hydraulic Oil Filter..... H-55270		DSM LGP (DOZERS) S/N: 5FS1-UP Air Filter Set..... A-5568-S Air Filter Secondary..... A-5567 Air Filter Primary..... A-5566 Fuel Filter Secondary..... FC-5515 Fuel Filter Secondary..... FC-55151 Fuel Filter..... FC-5516 Hydraulic Oil Filter..... H-5504 Hydraulic Oil Filter..... HC-55220 Hydraulic Oil Filter..... HC-5507 Hydraulic Oil Filter..... H-55270 Oil Filter Full Flow..... C-5510	
DSM (DOZERS) S/N: 3DR1-423 Air Filter Primary..... A-5566 Air Filter Set..... A-5568-S Air Filter Secondary..... A-5567 Hydraulic Oil Filter..... H-55270		DSM (DOZERS) S/N: 6GN1335-UP Air Filter Secondary..... A-5567 Air Filter Set..... A-5568-S Air Filter Primary..... A-5566 Hydraulic Oil Filter..... H-5526 Hydraulic Oil Filter..... H-55280 Hydraulic Oil Filter..... H-55270 Hydraulic Oil Filter..... H-5504		DSM LGP (DOZERS) S/N: 6AS1-UP Air Filter Primary..... A-5566 Air Filter Secondary..... A-5567 Air Filter Set..... A-5568-S Fuel Filter Secondary..... FC-55151 Fuel Filter Secondary..... FC-5515 Fuel Filter..... FC-5516 Hydraulic Oil Filter..... H-55270 Hydraulic Oil Filter..... H-5526 Hydraulic Oil Filter..... H-5504 Oil Filter Full Flow..... C-5510	
DSM (DOZERS) S/N: 3DR424-UP Air Filter Secondary..... A-5567 Air Filter Set..... A-5568-S Air Filter Primary..... A-5566 Hydraulic Oil Filter..... H-5526 Hydraulic Oil Filter..... H-55280 Hydraulic Oil Filter..... H-55270 Hydraulic Oil Filter..... H-5504		DSM (DOZERS) S/N: 6GN1-UP Air Filter Secondary..... A-5567 Air Filter Set..... A-5568-S Air Filter Primary..... A-5566 Fuel Filter..... FC-5516 Fuel Filter Secondary..... FC-5515 Fuel Filter..... FC-5508 Fuel Filter Secondary..... FC-55151 Hydraulic Oil Filter..... H-5504 Hydraulic Oil Filter..... H-55270 Hydraulic Oil Filter..... H-5526 Oil Filter Full Flow..... C-5510		DSM LGP (DOZERS) S/N: 6GN1-UP Air Filter Set..... A-5568-S Air Filter Secondary..... A-5567	
DSM (DOZERS) S/N: 4BR1-532 Air Filter Primary..... A-5566 Air Filter Set..... A-5568-S Air Filter Secondary..... A-5567 Hydraulic Oil Filter..... H-55270		DSM (DOZERS) S/N: 4BR1-UP Air Filter Secondary..... A-5567 Air Filter Set..... A-5568-S Air Filter Primary..... A-5566			

Sakura Filter

ENGINE APPLICATION

MODEL/APPLICATION	SAKURA NO	MODEL/APPLICATION	SAKURA NO	MODEL/APPLICATION	SAKURA NO				
CATERPILLAR		CATERPILLAR		CATERPILLAR					
DSM LGP (DOZERS) S/N: 6GN1-UP Air Filter Primary..... A-5566 Fuel Filter Secondary..... FC-5515 Fuel Filter Secondary..... FC-55151 Fuel Filter..... FC-5508 Fuel Filter..... FC-5516 Hydraulic Oil Filter..... H-55270 Hydraulic Oil Filter..... H-5504 Hydraulic Oil Filter..... H-5526 Oil Filter Full Flow..... C-5510		Hydraulic Oil Filter..... HC-55220 Hydraulic Oil Filter..... HC-5507 Hydraulic Oil Filter..... H-5504 Hydraulic Oil Filter..... H-55270 Oil Filter Full Flow..... C-5510 DSM XL (DOZERS) S/N: 6AS1-UP Air Filter Set..... A-5568-S Air Filter Primary..... A-5566 Air Filter Secondary..... A-5567 Fuel Filter Secondary..... FC-55151 Fuel Filter Secondary..... FC-5515 Fuel Filter..... FC-5516 Hydraulic Oil Filter..... H-5526 Hydraulic Oil Filter..... H-55270 Hydraulic Oil Filter..... H-5504 Oil Filter Full Flow..... C-5510 DSN (DOZERS) CAT (S/N: BMA1-UP) Fuel Filter..... FC-5517 Oil Filter Full Flow..... C-5522 DSN (DOZERS) S/N: AGG1-195-UP Air Filter Primary..... A-5558 Air Filter Secondary..... A-5550 Air Filter..... A-5547 Hydraulic Oil Filter..... H-5526 Hydraulic Oil Filter..... H-55280 Hydraulic Oil Filter..... H-5510 Hydraulic Oil Filter..... HC-55220 Hydraulic Oil Filter..... HC-5507 DSN (DOZERS) S/N: AGG196-331-UP Air Filter..... A-5547 Air Filter Primary..... A-5549 Air Filter Secondary..... A-5550 Air Filter Set..... A-5549M-S Air Filter Primary..... A-5549M Hydraulic Oil Filter..... HC-5507 Hydraulic Oil Filter..... HC-55220 Hydraulic Oil Filter..... H-5510 Hydraulic Oil Filter..... H-5526 DSN (DOZERS) S/N: AGG332-UP Air Filter Primary..... A-5549M Air Filter Set..... A-5549M-S Air Filter Secondary..... A-5550 Air Filter Primary..... A-5549 Air Filter..... A-5547 Hydraulic Oil Filter..... H-5526 Hydraulic Oil Filter..... H-55280 Hydraulic Oil Filter..... H-5510 DSN (DOZERS) S/N: AKD1-315-UP Air Filter Secondary..... A-5550 Air Filter Primary..... A-5558 Air Filter..... A-5547 Hydraulic Oil Filter..... H-5526		Hydraulic Oil Filter..... H-5510 Hydraulic Oil Filter..... HC-55220 Hydraulic Oil Filter..... H-55280 Hydraulic Oil Filter..... HC-5507 DSN (DOZERS) S/N: AKD316-411-UP Air Filter Primary..... A-5549M Air Filter..... A-5547 Air Filter Primary..... A-5549 Air Filter Secondary..... A-5550 Air Filter Set..... A-5549M-S Hydraulic Oil Filter..... H-5526 Hydraulic Oil Filter..... HC-55220 Hydraulic Oil Filter..... H-5510 Hydraulic Oil Filter..... HC-5507 DSN (DOZERS) S/N: AKD412-UP Air Filter Primary..... A-5549 Air Filter..... A-5547 Air Filter Set..... A-5549M-S Air Filter Secondary..... A-5550 Air Filter Primary..... A-5549M Hydraulic Oil Filter..... H-55280 Hydraulic Oil Filter..... H-5510 Hydraulic Oil Filter..... H-5526 DSN (DOZERS) w/3126B Eng. Hydraulic Oil Filter..... HC-55280 DSR LGP (DOZERS) w/C6.6 Eng. Fuel/Water Separator..... SFC-55170 DSR XL (DOZERS) w/C6.6 Eng. Fuel/Water Separator..... SFC-55170 D5 TURBO (DOZERS) Air Filter Set..... A-5522-S Air Filter Secondary..... A-5510 Air Filter Primary..... A-5509 Air Filter Secondary..... A-5508 Air Filter Set..... A-55071-S Air Filter Set..... A-5507-S Air Filter Primary..... A-5507 Fuel Filter..... F-5501 Fuel Filter..... FC-5501 Fuel Filter Secondary..... FC-5507 Hydraulic Oil Filter..... H-5504 Oil Filter Full Flow..... O-5502 Oil Filter Full Flow..... C-5510 D6 (DOZERS) CAT 3306 Fuel Filter..... F-5503 D6 (DOZERS) (DOZERS) Fuel Filter..... F-5503 D6 (DOZERS) (DOZERS) S/N: 10K2691-UP					
DSM LGPXL (DOZERS) CAT 3116 Air Filter Primary..... A-5566 Air Filter Secondary..... A-5567 Air Filter Set..... A-5568-S Fuel Filter..... FC-5508 Fuel Filter Secondary..... FC-55151 Fuel Filter Secondary..... FC-5515 Fuel Filter..... FC-5516 Hydraulic Oil Filter..... H-5504 Hydraulic Oil Filter..... HC-5507 Oil Filter Full Flow..... C-5510		DSM XL (DOZERS) CAT 3116 Cabin Air Filter..... CA-55140		DSM XL (DOZERS) S/N: 4JS1-UP Air Filter Set..... A-5568-S Air Filter Secondary..... A-5567 Air Filter Primary..... A-5566 Fuel Filter Secondary..... FC-5515 Fuel Filter Secondary..... FC-55151 Fuel Filter..... FC-5516 Hydraulic Oil Filter..... H-5504 Hydraulic Oil Filter..... H-55270 Hydraulic Oil Filter..... HC-55220 Hydraulic Oil Filter..... HC-5507 Oil Filter Full Flow..... C-5510		DSM XL (DOZERS) S/N: 5ES1-UP Air Filter Set..... A-5568-S Air Filter Primary..... A-5566 Air Filter Secondary..... A-5567 Fuel Filter..... FC-5516 Fuel Filter Secondary..... FC-55151 Fuel Filter Secondary..... FC-5515 Hydraulic Oil Filter..... H-5526 Hydraulic Oil Filter..... H-55270 Hydraulic Oil Filter..... H-5504 Oil Filter Full Flow..... C-5510		DSM XL (DOZERS) S/N: 5FS1-UP Air Filter Set..... A-5568-S Air Filter Secondary..... A-5567 Air Filter Primary..... A-5566 Fuel Filter Secondary..... FC-5515 Fuel Filter Secondary..... FC-55151 Fuel Filter..... FC-5516	

Sakura Filter

ENGINE APPLICATION

MODEL/APPLICATION	SAKURA NO	MODEL/APPLICATION	SAKURA NO	MODEL/APPLICATION	SAKURA NO
CATERPILLAR		CATERPILLAR		CATERPILLAR	
D6 (DOZERS) S/N: 10K2691-UP Air Filter Secondary..... A-5502 Air Filter Primary..... A-5501 Air Filter Secondary..... A-5534 Air Filter Primary..... A-5535 Air Filter Set..... A-5573-S Hydraulic Oil Filter..... H-5503 Oil Filter Full Flow..... C-5510		Air Filter Set..... A-5522-S Air Filter Primary..... A-5549M Air Filter Primary..... A-5509 Air Filter Secondary..... A-5510 Air Filter Set..... A-5549M-S Fuel Filter..... F-5501 Hydraulic Oil Filter..... H-5504 Oil Filter Full Flow..... O-5502		Air Filter Secondary..... A-5567 Air Filter Primary..... A-5566 Air Filter Set..... A-5568-S Air Filter Set..... A-5507-S Air Filter Primary..... A-5507 Air Filter Secondary..... A-5508 Air Filter Set..... A-55071-S Fuel Filter..... F-5501 Hydraulic Oil Filter..... H-5504 Oil Filter Full Flow..... O-5502	
D6 (DOZERS) S/N: 1Y1-UP Air Filter Set..... A-5549M-S Air Filter Primary..... A-5549 Air Filter Secondary..... A-5550 Air Filter Set..... A-5522-S Air Filter Primary..... A-5549M Air Filter Primary..... A-5509 Air Filter Secondary..... A-5510 Hydraulic Oil Filter..... H-5503 Oil Filter Full Flow..... O-5502 Oil Filter Full Flow..... C-5510		D6 (DOZERS) S/N: 8U1-UP Oil Filter Full Flow..... O-5501		D6C (DOZERS) S/N: 10K11940-UP Air Filter Primary..... A-5501 Air Filter Secondary..... A-5502 Air Filter Secondary..... A-5534 Air Filter Primary..... A-5535 Air Filter Set..... A-5573-S Fuel Filter Secondary..... FC-5507 Hydraulic Oil Filter..... H-5503 Hydraulic Oil Filter..... H-5502 Hydraulic Oil Filter..... H-5508 Oil Filter Full Flow..... C-5510	
D6 (DOZERS) S/N: 33X1-UP Air Filter Secondary..... A-5534 Air Filter Primary..... A-5501 Air Filter Primary..... A-5535 Air Filter Set..... A-5573-S Air Filter Secondary..... A-5502 Hydraulic Oil Filter..... H-5502 Hydraulic Oil Filter..... H-5508 Hydraulic Oil Filter..... H-5503 Oil Filter Full Flow..... C-5510		D6B (DOZERS) S/N: 37A1-UP Air Filter Set..... A-55071-S Air Filter Secondary..... A-5508 Air Filter Primary..... A-5507 Air Filter Set..... A-5507-S Air Filter Set..... A-5568-S Air Filter Primary..... A-5566 Air Filter Secondary..... A-5567 Fuel Filter..... F-5501 Hydraulic Oil Filter..... H-5504 Oil Filter Full Flow..... O-5502		D6C (DOZERS) S/N: 10K1-5984 Air Filter Primary..... A-5549M Air Filter Primary..... A-5549 Air Filter Primary..... A-5509 Air Filter Set..... A-5522-S Air Filter Secondary..... A-5510 Air Filter Set..... A-5549M-S Air Filter Secondary..... A-5550 Fuel Filter Secondary..... FC-5507 Hydraulic Oil Filter..... H-5503 Oil Filter Full Flow..... O-5502	
D6 (DOZERS) S/N: 74A1-1751 Air Filter Set..... A-5549M-S Air Filter Secondary..... A-5550 Air Filter Primary..... A-5549 Air Filter Primary..... A-5549M Air Filter Set..... A-5522-S Air Filter Secondary..... A-5510 Air Filter Primary..... A-5509 Fuel Filter..... F-5501 Hydraulic Oil Filter..... H-5504 Oil Filter Full Flow..... O-5502		D6B (DOZERS) S/N: 44A1-UP Air Filter Secondary..... A-5567 Air Filter Primary..... A-5566 Air Filter Set..... A-5568-S Air Filter Set..... A-5507-S Air Filter Primary..... A-5507 Air Filter Secondary..... A-5508 Air Filter Set..... A-55071-S Fuel Filter..... F-5501 Hydraulic Oil Filter..... H-5504 Oil Filter Full Flow..... O-5502		D6C (DOZERS) S/N: 10K5985-6290 Air Filter Secondary..... A-5534 Air Filter Secondary..... A-5502 Air Filter Primary..... A-5501 Air Filter Primary..... A-5535 Air Filter Set..... A-5573-S Fuel Filter Secondary..... FC-5507 Hydraulic Oil Filter..... H-5503 Oil Filter Full Flow..... O-5502	
D6 (DOZERS) S/N: 75W1-UP Air Filter Secondary..... A-5534 Air Filter Primary..... A-5501 Air Filter Primary..... A-5535 Air Filter Set..... A-5573-S Air Filter Secondary..... A-5502 Hydraulic Oil Filter..... H-5503 Hydraulic Oil Filter..... H-5508 Hydraulic Oil Filter..... H-5502 Oil Filter Full Flow..... C-5510		D6B (DOZERS) S/N: 56A1-UP Air Filter Set..... A-55071-S Air Filter Secondary..... A-5508 Air Filter Primary..... A-5507 Air Filter Set..... A-5507-S Air Filter Set..... A-5568-S Air Filter Primary..... A-5566 Air Filter Secondary..... A-5567 Fuel Filter..... F-5501 Hydraulic Oil Filter..... H-5504 Oil Filter Full Flow..... O-5502		D6C (DOZERS) S/N: 10K5985-7952 Air Filter Primary..... A-5549M Air Filter Primary..... A-5549 Air Filter Primary..... A-5501 Air Filter Secondary..... A-5502 Air Filter Secondary..... A-5550 Air Filter Set..... A-5549M-S Fuel Filter Secondary..... FC-5507 Hydraulic Oil Filter..... H-5503 Oil Filter Full Flow..... C-5510	
D6 (DOZERS) S/N: 76A1-2891 Air Filter Primary..... A-5549 Air Filter Secondary..... A-5550		D6B (DOZERS) S/N: 57A1-UP Air Filter Primary..... A-5501 Air Filter Secondary..... A-5534		D6C (DOZERS) S/N: 10K7953-11939 Air Filter Primary..... A-5501 Air Filter Secondary..... A-5534	

MODEL/APPLICATION	SAKURA NO
CATERPILLAR	
D6C (DOZERS) S/N: 10K7953-11939	
Air Filter Primary.....	A-5535
Air Filter Set.....	A-5573-S
Hydraulic Oil Filter.....	H-5503
Oil Filter Full Flow.....	C-5510
D6C (DOZERS) S/N: 17R1284-UP	
Air Filter Primary.....	A-5509
Air Filter Secondary.....	A-5510
Air Filter Set.....	A-5522-S
Fuel Filter Secondary.....	FC-5507
Hydraulic Oil Filter.....	H-5503
Oil Filter Full Flow.....	C-5510
Oil Filter Full Flow.....	O-5501
D6C (DOZERS) S/N: 17R465-1283	
Air Filter Primary.....	A-5549M
Air Filter Primary.....	A-5549
Air Filter Set.....	A-5522-S
Air Filter Secondary.....	A-5510
Air Filter Set.....	A-5549M-S
Air Filter Secondary.....	A-5550
Air Filter Primary.....	A-5509
Fuel Filter Secondary.....	FC-5507
Hydraulic Oil Filter.....	H-5503
Oil Filter Full Flow.....	C-5510
D6C (DOZERS) S/N: 3X-UP	
Air Filter Primary.....	A-5535
Air Filter Set.....	A-5573-S
Air Filter Secondary.....	A-5534
Air Filter Primary.....	A-5501
Air Filter Secondary.....	A-5502
Fuel Filter Secondary.....	FC-5507
Hydraulic Oil Filter.....	H-5503
Oil Filter Full Flow.....	C-5510
D6C (DOZERS) S/N: 4X-UP	
Air Filter Set.....	A-5573-S
Air Filter Primary.....	A-5535
Air Filter Secondary.....	A-5502
Air Filter Primary.....	A-5501
Air Filter Secondary.....	A-5534
Fuel Filter Secondary.....	FC-5507
Hydraulic Oil Filter.....	H-5503
Oil Filter Full Flow.....	C-5510
D6C (DOZERS) S/N: 5X-UP	
Air Filter Primary.....	A-5535
Air Filter Set.....	A-5573-S
Air Filter Secondary.....	A-5534
Air Filter Primary.....	A-5501
Air Filter Secondary.....	A-5502
Fuel Filter Secondary.....	FC-5507
Hydraulic Oil Filter.....	H-5503
Oil Filter Full Flow.....	C-5510

MODEL/APPLICATION	SAKURA NO
CATERPILLAR	
D6C (DOZERS) S/N: 69U1-UP	
Air Filter Set.....	A-5573-S
Air Filter Primary.....	A-5535
Air Filter Secondary.....	A-5502
Air Filter Primary.....	A-5501
Air Filter Secondary.....	A-5534
Fuel Filter Secondary.....	FC-5507
Hydraulic Oil Filter.....	H-5503
Oil Filter Full Flow.....	C-5510
D6C (DOZERS) S/N: 6X-UP	
Air Filter Secondary.....	A-5534
Air Filter Primary.....	A-5501
Air Filter Secondary.....	A-5502
Air Filter Primary.....	A-5535
Air Filter Set.....	A-5573-S
Fuel Filter Secondary.....	FC-5507
Hydraulic Oil Filter.....	H-5503
Oil Filter Full Flow.....	C-5510
D6C (DOZERS) S/N: 74A1-1751	
Air Filter Primary.....	A-5509
Air Filter Secondary.....	A-5550
Air Filter Set.....	A-5549M-S
Air Filter Secondary.....	A-5510
Air Filter Set.....	A-5522-S
Air Filter Primary.....	A-5549M
Air Filter Primary.....	A-5549
Fuel Filter.....	F-5501
Hydraulic Oil Filter.....	H-5504
Oil Filter Full Flow.....	O-5502
D6C (DOZERS) S/N: 74A1752-UP	
Air Filter Primary.....	A-5549
Air Filter Primary.....	A-5549M
Air Filter Set.....	A-5522-S
Air Filter Secondary.....	A-5510
Air Filter Set.....	A-5549M-S
Air Filter Secondary.....	A-5550
Air Filter Primary.....	A-5509
Fuel Filter.....	F-5501
Hydraulic Oil Filter.....	H-5503
Oil Filter Full Flow.....	O-5502
D6C (DOZERS) S/N: 76A1-2891	
Air Filter Primary.....	A-5509
Air Filter Secondary.....	A-5550
Air Filter Set.....	A-5549M-S
Air Filter Secondary.....	A-5510
Air Filter Set.....	A-5522-S
Air Filter Primary.....	A-5549M
Air Filter Primary.....	A-5549
Fuel Filter.....	F-5501
Hydraulic Oil Filter.....	H-5504
Oil Filter Full Flow.....	O-5502
D6C (DOZERS) S/N: 76A2892-UP	
Air Filter Primary.....	A-5501

MODEL/APPLICATION	SAKURA NO
CATERPILLAR	
Air Filter Primary.....	A-5549
Air Filter Primary.....	A-5549M
Air Filter Set.....	A-5522-S
Air Filter Secondary.....	A-5510
Air Filter Set.....	A-5549M-S
Air Filter Secondary.....	A-5550
Air Filter Primary.....	A-5509
Fuel Filter.....	F-5501
Hydraulic Oil Filter.....	H-5503
Oil Filter Full Flow.....	O-5502
D6C (DOZERS) S/N: 82A1-UP	
Hydraulic Oil Filter.....	H-5502
Hydraulic Oil Filter.....	H-5508
D6C (DOZERS) S/N: 99J1-1550	
Air Filter Primary.....	A-5549M
Air Filter Primary.....	A-5549
Air Filter Primary.....	A-5509
Air Filter Secondary.....	A-5550
Air Filter Set.....	A-5549M-S
Air Filter Secondary.....	A-5510
Air Filter Set.....	A-5522-S
Fuel Filter Secondary.....	FC-5507
Hydraulic Oil Filter.....	H-5503
Oil Filter Full Flow.....	O-5502
D6C (DOZERS) S/N: 99J1551-1592	
Air Filter Primary.....	A-5535
Air Filter Set.....	A-5573-S
Air Filter Secondary.....	A-5534
Air Filter Secondary.....	A-5502
Air Filter Primary.....	A-5501
Fuel Filter Secondary.....	FC-5507
Hydraulic Oil Filter.....	H-5503
Oil Filter Full Flow.....	O-5502
D6C (DOZERS) S/N: 99J1593-1753	
Air Filter Set.....	A-5573-S
Air Filter Primary.....	A-5535
Air Filter Primary.....	A-5501
Air Filter Secondary.....	A-5502
Air Filter Secondary.....	A-5534
Fuel Filter Secondary.....	FC-5507
Hydraulic Oil Filter.....	H-5503
Oil Filter Full Flow.....	C-5510
D6C (DOZERS) S/N: 99J1754-2534	
Air Filter Primary.....	A-5535
Air Filter Set.....	A-5573-S
Air Filter Secondary.....	A-5534
Air Filter Secondary.....	A-5502
Air Filter Primary.....	A-5501
Fuel Filter Secondary.....	FC-5507
Hydraulic Oil Filter.....	H-5503
Oil Filter Full Flow.....	C-5510
D6C (DOZERS) S/N: 99J2535-UP	
Air Filter Primary.....	A-5501

MODEL/APPLICATION	SAKURA NO	MODEL/APPLICATION	SAKURA NO	MODEL/APPLICATION	SAKURA NO
CATERPILLAR		CATERPILLAR		CATERPILLAR	
D6C (DOZERS) S/N: 99J2535-UP Air Filter Secondary..... A-5502 Air Filter Secondary..... A-5534 Air Filter Set..... A-5573-S Air Filter Primary..... A-5535 Fuel Filter Secondary..... FC-5507 Hydraulic Oil Filter..... H-5503 Oil Filter Full Flow..... C-5510		Hydraulic Oil Filter..... H-5502 Oil Filter Full Flow..... C-5510 D6D (DOZERS) S/N: 30X1-2069 Air Filter Set..... A-5573-S Air Filter Secondary..... A-5534 Air Filter Primary..... A-5535 D6D (DOZERS) S/N: 30X1-UP Air Filter Secondary..... A-5502 Air Filter Primary..... A-5501 Fuel Filter Secondary..... FC-5507 Hydraulic Oil Filter..... H-5526 Hydraulic Oil Filter..... H-55280 Hydraulic Oil Filter..... H-5502 Hydraulic Oil Filter..... H-5508 Hydraulic Oil Filter..... H-5503 Oil Filter Full Flow..... C-5510 D6D (DOZERS) S/N: 30X2070-UP Air Filter Primary..... A-5501 Air Filter Secondary..... A-5502 Fuel Filter Secondary..... FC-5507 Hydraulic Oil Filter..... H-5503 Hydraulic Oil Filter..... H-5508 Hydraulic Oil Filter..... H-5502 Hydraulic Oil Filter..... H-5504 Hydraulic Oil Filter..... H-5503 Oil Filter Full Flow..... C-5510 D6D (DOZERS) S/N: 31X1497-UP Air Filter Primary..... A-5535 Air Filter Secondary..... A-5534 Air Filter Set..... A-5573-S Air Filter Secondary..... A-5502 Air Filter Primary..... A-5501 Fuel Filter Secondary..... FC-5507 Hydraulic Oil Filter..... H-5502 Hydraulic Oil Filter..... H-5508 Hydraulic Oil Filter..... H-5503 Oil Filter Full Flow..... C-5510 D6D (DOZERS) S/N: 32X1-1179 Air Filter Set..... A-5573-S Air Filter Secondary..... A-5534 Air Filter Primary..... A-5535 D6D (DOZERS) S/N: 32X1181-UP Air Filter Primary..... A-5535 Air Filter Secondary..... A-5534 Air Filter Set..... A-5573-S Air Filter Primary..... A-5501 Air Filter Secondary..... A-5502 Fuel Filter Secondary..... FC-5507 Hydraulic Oil Filter..... H-5503 Hydraulic Oil Filter..... H-5508 Hydraulic Oil Filter..... H-5502 Oil Filter Full Flow..... C-5510 D6D (DOZERS) S/N: 33X410-UP		Air Filter Secondary..... A-5502 Air Filter Primary..... A-5501 Fuel Filter Secondary..... FC-5507 Hydraulic Oil Filter..... H-5502 Hydraulic Oil Filter..... H-5508 Hydraulic Oil Filter..... H-5503 Hydraulic Oil Filter..... H-55280 Hydraulic Oil Filter..... H-5526 Oil Filter Full Flow..... C-5510 D6D (DOZERS) S/N: 36C100-UP Air Filter Primary..... A-5501 Air Filter Secondary..... A-5502 Fuel Filter Secondary..... FC-5507 Hydraulic Oil Filter..... H-5526 Hydraulic Oil Filter..... H-55280 Hydraulic Oil Filter..... H-5503 Hydraulic Oil Filter..... H-5508 Hydraulic Oil Filter..... H-5502 Oil Filter Full Flow..... C-5510 D6D (DOZERS) S/N: 37C200-UP Air Filter Secondary..... A-5502 Air Filter Primary..... A-5501 Fuel Filter Secondary..... FC-5507 Hydraulic Oil Filter..... H-5502 Hydraulic Oil Filter..... H-5508 Hydraulic Oil Filter..... H-5503 Hydraulic Oil Filter..... H-55280 Hydraulic Oil Filter..... H-5526 Oil Filter Full Flow..... C-5510 D6D (DOZERS) S/N: 38C100-UP Air Filter Secondary..... A-5510 Air Filter Set..... A-5522-S Air Filter Secondary..... A-5522 Air Filter Primary..... A-5509 Fuel Filter..... F-5505 Fuel Filter Secondary..... FC-5507 Hydraulic Oil Filter..... H-5504 Hydraulic Oil Filter..... H-5503 Hydraulic Oil Filter..... H-5526 Hydraulic Oil Filter..... H-55280 Hydraulic Oil Filter..... H-55270 Oil Filter Full Flow..... C-5510 D6D (DOZERS) S/N: 3X1-UP Air Filter Set..... A-5573-S Air Filter Secondary..... A-5534 Air Filter Primary..... A-5535 Air Filter Primary..... A-5501 Air Filter Secondary..... A-5502 Fuel Filter..... F-5505 Hydraulic Oil Filter..... H-5503 Hydraulic Oil Filter..... H-5508 Hydraulic Oil Filter..... H-5502 Oil Filter Full Flow..... C-5510 D6D (DOZERS) S/N: 4X1-UP	

MODEL/APPLICATION	SAKURA NO	MODEL/APPLICATION	SAKURA NO	MODEL/APPLICATION	SAKURA NO
CATERPILLAR		CATERPILLAR		CATERPILLAR	
D6D (DOZERS) S/N: 4X1-UP		Oil Filter Full Flow.....	C-5510	Air Filter Primary.....	A-5535
Air Filter Secondary.....	A-5502	D6D (DOZERS) S/N: 74W1-2560		D6E (DOZERS) S/N: 2MJ1-1206	
Air Filter Primary.....	A-5501	Air Filter Primary.....	A-5535	Air Filter Primary.....	A-5535
Air Filter Primary.....	A-5535	Air Filter Secondary.....	A-5534	Air Filter Secondary.....	A-5534
Air Filter Secondary.....	A-5534	Air Filter Set.....	A-5573-S	Air Filter Set.....	A-5573-S
Air Filter Set.....	A-5573-S	D6D (DOZERS) S/N: 74W2561-UP		D6E (DOZERS) S/N: 2MJ1158-2653	
Fuel Filter Secondary.....	FC-5507	Air Filter Set.....	A-5573-S	Air Filter Primary.....	A-5501
Hydraulic Oil Filter.....	H-5502	Air Filter Secondary.....	A-5534	Air Filter Secondary.....	A-5502
Hydraulic Oil Filter.....	H-5508	Air Filter Primary.....	A-5535	Fuel Filter Secondary.....	FC-5507
Hydraulic Oil Filter.....	H-5503	Air Filter Primary.....	A-5501	Hydraulic Oil Filter.....	H-5503
Oil Filter Full Flow.....	C-5510	Air Filter Secondary.....	A-5502	Hydraulic Oil Filter.....	H-5502
D6D (DOZERS) S/N: 5X1-UP		Fuel Filter.....	F-5505	Hydraulic Oil Filter.....	H-5508
Air Filter Set.....	A-5522-S	Hydraulic Oil Filter.....	H-5508	Oil Filter Full Flow.....	C-5510
Air Filter Secondary.....	A-5510	Hydraulic Oil Filter.....	H-5502	D6E (DOZERS) S/N: 2MJ1-UP	
Air Filter Set.....	A-5573-S	Hydraulic Oil Filter.....	H-5503	Air Filter Secondary.....	A-5502
Air Filter Secondary.....	A-5534	Hydraulic Oil Filter.....	H-5502	Air Filter Primary.....	A-5501
Air Filter Primary.....	A-5535	Oil Filter Full Flow.....	C-5510	Fuel Filter Secondary.....	FC-5507
Air Filter Primary.....	A-5509	D6D (DOZERS) S/N: 75W1-UP		Fuel Filter.....	F-5505
Fuel Filter.....	F-5505	Air Filter Secondary.....	A-5502	Hydraulic Oil Filter.....	H-5526
Hydraulic Oil Filter.....	H-5503	Air Filter Primary.....	A-5501	Hydraulic Oil Filter.....	H-55280
Oil Filter Full Flow.....	C-5510	Air Filter Primary.....	A-5535	Hydraulic Oil Filter.....	H-5508
Oil Filter Full Flow.....	O-5502	Air Filter Secondary.....	A-5534	Hydraulic Oil Filter.....	H-5502
D6D (DOZERS) S/N: 5YB800-UP		Air Filter Set.....	A-5573-S	Hydraulic Oil Filter.....	H-5502
Fuel Filter Secondary.....	FC-5507	Air Filter Secondary.....	FC-5507	Hydraulic Oil Filter.....	H-5503
Fuel Filter.....	F-5505	Fuel Filter Secondary.....	FC-5507	Hydraulic Oil Filter.....	H-5526
Hydraulic Oil Filter.....	H-5503	Hydraulic Oil Filter.....	H-5502	Hydraulic Oil Filter.....	H-55280
Hydraulic Oil Filter.....	H-55280	Hydraulic Oil Filter.....	H-5508	Hydraulic Oil Filter.....	H-5508
Hydraulic Oil Filter.....	H-5526	Hydraulic Oil Filter.....	H-5503	Hydraulic Oil Filter.....	H-5502
D6D (DOZERS) S/N: 6HC1-2574		Oil Filter Full Flow.....	C-5510	Oil Filter Full Flow.....	C-5510
Air Filter Primary.....	A-5535	D6D (DOZERS) S/N: 7YK1-UP		D6E (DOZERS) S/N: 8FG1-UP	
Air Filter Secondary.....	A-5534	Air Filter Primary.....	A-5501	Air Filter Set.....	A-5549M-S
Air Filter Set.....	A-5573-S	Air Filter Secondary.....	A-5502	Air Filter Secondary.....	A-5550
D6D (DOZERS) S/N: 6HC1-UP		Fuel Filter Secondary.....	FC-5507	Air Filter Primary.....	A-5549
Air Filter Primary.....	A-5501	Fuel Filter.....	F-5505	Air Filter Primary.....	A-5549M
Air Filter Secondary.....	A-5502	Hydraulic Oil Filter.....	H-5508	D6E (DOZERS) w/3306 Eng.	
Fuel Filter.....	F-5505	Hydraulic Oil Filter.....	H-5502	Air Filter Primary.....	A-5535M
Fuel Filter Secondary.....	FC-5507	Hydraulic Oil Filter.....	H-55280	Air Filter Set.....	A-5573M-S
Hydraulic Oil Filter.....	H-5508	Hydraulic Oil Filter.....	H-5526	D6E SR (DOZERS) S/N: 8FJ1-UP	
Hydraulic Oil Filter.....	H-5502	Hydraulic Oil Filter.....	H-5503	Air Filter Set.....	A-5522-S
Hydraulic Oil Filter.....	H-5526	Hydraulic Oil Filter.....	H-55280	Air Filter Secondary.....	A-5510
Hydraulic Oil Filter.....	H-55280	Hydraulic Oil Filter.....	H-5526	Air Filter Primary.....	A-5509
Hydraulic Oil Filter.....	H-5503	Oil Filter Full Flow.....	C-5510	Fuel Filter.....	F-5505
Oil Filter Full Flow.....	C-5510	D6D (DOZERS) S/N: 9FK1-UP		Hydraulic Oil Filter.....	H-5502
D6D (DOZERS) S/N: 6X1-UP		Air Filter Secondary.....	A-5502	Hydraulic Oil Filter.....	H-5508
Air Filter Secondary.....	A-5502	Air Filter Primary.....	A-5501	Hydraulic Oil Filter.....	H-5502
Air Filter Primary.....	A-5501	Fuel Filter Secondary.....	FC-5507	Hydraulic Oil Filter.....	H-5508
Air Filter Set.....	A-5573-S	Fuel Filter.....	F-5505	Oil Filter Full Flow.....	C-5510
Air Filter Secondary.....	A-5534	Hydraulic Oil Filter.....	H-5503	D6E SR (DOZERS) w/3306 Eng.	
Air Filter Primary.....	A-5535	Hydraulic Oil Filter.....	H-5502	Air Filter Primary.....	A-5535M
Fuel Filter Secondary.....	FC-5507	Hydraulic Oil Filter.....	H-5526	Air Filter Set.....	A-5573M-S
Hydraulic Oil Filter.....	H-5502	Hydraulic Oil Filter.....	H-5508	D6F SR (DOZERS) CAT 3306T (S/N: 5FR1-UP)	
Hydraulic Oil Filter.....	H-5508	Hydraulic Oil Filter.....	H-55280	Air Filter Primary.....	A-5535
Hydraulic Oil Filter.....	H-5503	Oil Filter Full Flow.....	C-5510	Air Filter Secondary.....	A-5534
D6D (DOZERS) S/N: 1207-1207		D6E (DOZERS) S/N: 1207-1207		Air Filter Set.....	A-5573-S
Air Filter Secondary.....	A-5502	Air Filter Set.....	A-5573-S	Fuel Filter.....	F-5505
Air Filter Primary.....	A-5501	Air Filter Secondary.....	A-5534	Fuel Filter Secondary.....	FC-5507
Air Filter Set.....	A-5573-S	D6E (DOZERS) S/N: 1207-1207		Hydraulic Oil Filter.....	H-5503
Air Filter Secondary.....	A-5534	Air Filter Set.....	A-5573-S	D6F SR (DOZERS) CAT 3306T (S/N: 5FR1-UP)	
Air Filter Primary.....	A-5535	Air Filter Secondary.....	A-5534	Air Filter Primary.....	A-5535
Fuel Filter Secondary.....	FC-5507	D6E (DOZERS) S/N: 1207-1207		Air Filter Secondary.....	A-5534
Hydraulic Oil Filter.....	H-5502	Air Filter Set.....	A-5573-S	Air Filter Set.....	A-5573-S
Hydraulic Oil Filter.....	H-5508	Air Filter Secondary.....	A-5534	Fuel Filter.....	F-5505
Hydraulic Oil Filter.....	H-5503	D6E (DOZERS) S/N: 1207-1207		Fuel Filter Secondary.....	FC-5507
D6D (DOZERS) S/N: 6X1-UP		Air Filter Set.....	A-5573-S	Hydraulic Oil Filter.....	H-5503
Air Filter Secondary.....	A-5502	Air Filter Secondary.....	A-5534		
Air Filter Primary.....	A-5501				
Air Filter Set.....	A-5573-S				
Air Filter Secondary.....	A-5534				
Air Filter Primary.....	A-5535				
Fuel Filter Secondary.....	FC-5507				
Hydraulic Oil Filter.....	H-5502				
Hydraulic Oil Filter.....	H-5508				
Hydraulic Oil Filter.....	H-5503				

MODEL/APPLICATION	SAKURA NO
CATERPILLAR	
D6F SR (DOZERS) CAT 3306T (S/N: 5FR1-UP)	
Hydraulic Oil Filter.....	H-55280
Hydraulic Oil Filter.....	H-5526
Hydraulic Oil Filter.....	HC-5506
Hydraulic Oil Filter.....	HC-5512
Hydraulic Oil Filter.....	HC-5503
Oil Filter Full Flow.....	C-5510
D6F SR (DOZERS) w/3306 Eng.	
Air Filter Primary.....	A-5535M
Air Filter Set.....	A-5573M-S
D6G (DOZERS) CAT 3306T (S/N: 3SR1-UP)	
Air Filter Secondary.....	A-5534
Air Filter Primary.....	A-5535
Air Filter Set.....	A-5573-S
Fuel Filter.....	F-5505
Fuel Filter Secondary.....	FC-5507
Hydraulic Oil Filter.....	H-5526
Hydraulic Oil Filter.....	H-55280
Hydraulic Oil Filter.....	H-5503
Hydraulic Oil Filter.....	HC-5503
Hydraulic Oil Filter.....	HC-5512
Hydraulic Oil Filter.....	HC-5506
Oil Filter Full Flow.....	C-5510
D6G II (DOZERS) CAT S/N: 10Z1-UP	
Air Filter Secondary.....	A-5550
Fuel Filter Secondary.....	FC-5507
Fuel/Water Separator Secondary..	SFC-5504-10B
Fuel/Water Separator Secondary..	SFC-5504-10
Hydraulic Oil Filter.....	H-55280
Hydraulic Oil Filter.....	H-5526
Hydraulic Oil Filter.....	HC-5506
Hydraulic Oil Filter.....	HC-5512
Hydraulic Oil Filter.....	HC-5503
Oil Filter Full Flow.....	C-5522
D6G II (DOZERS) CAT S/N: C6G1000-UP	
Air Filter Secondary.....	A-5550
Fuel Filter Secondary.....	FC-5507
Fuel/Water Separator Secondary..	SFC-5504-10
Fuel/Water Separator Secondary..	SFC-5504-10B
Hydraulic Oil Filter.....	HC-5503
Hydraulic Oil Filter.....	HC-5512
Hydraulic Oil Filter.....	HC-5506
Hydraulic Oil Filter.....	H-5526
Hydraulic Oil Filter.....	H-55280
Oil Filter Full Flow.....	C-5522
D6G SR (DOZERS) S/N: 2MJ,3SR-UP	
Air Filter Secondary.....	A-5534
Air Filter Primary.....	A-5535
Air Filter Set.....	A-5573-S
Fuel Filter.....	F-5505
Fuel Filter Secondary.....	FC-5507
Hydraulic Oil Filter.....	H-5503

MODEL/APPLICATION	SAKURA NO
CATERPILLAR	
Hydraulic Oil Filter.....	HC-5503
Hydraulic Oil Filter.....	HC-5506
Oil Filter Full Flow.....	C-5510
D6G SR (DOZERS) w/3306 Eng.	
Air Filter Set.....	A-5573M-S
Air Filter Primary.....	A-5535M
D6H (DOZERS) CAT 3306	
Cabin Air Filter.....	CA-55140
D6H (DOZERS) Excluding S/N: UP	
Air Filter Secondary.....	A-5522
Air Filter Set.....	A-5522-S
Air Filter Primary.....	A-5509
Hydraulic Oil Filter.....	H-5526
Hydraulic Oil Filter.....	H-55280
Hydraulic Oil Filter.....	HC-55310
D6H (DOZERS) S/N: 1FJ1-481	
Air Filter Primary.....	A-5509
Air Filter Set.....	A-5522-S
Air Filter Secondary.....	A-5522
Hydraulic Oil Filter.....	H-5503
D6H (DOZERS) S/N: 1FJ1-UP	
Air Filter Secondary.....	A-5522
Air Filter Set.....	A-5522-S
Air Filter Primary.....	A-5509
Fuel Filter Secondary.....	FC-5507
Fuel Filter.....	F-5505
Hydraulic Oil Filter.....	H-5503
Hydraulic Oil Filter.....	H-55280
Hydraulic Oil Filter.....	H-5526
Hydraulic Oil Filter.....	H-5510
Oil Filter Full Flow.....	C-5510
D6H (DOZERS) S/N: 1FJ4000-5499	
Air Filter Primary.....	A-5509
Air Filter Set.....	A-5522-S
Air Filter Secondary.....	A-5522
Hydraulic Oil Filter.....	H-5503
Hydraulic Oil Filter.....	H-5510
D6H (DOZERS) S/N: 1FJ482-3999	
Air Filter Secondary.....	A-5522
Air Filter Set.....	A-5522-S
Air Filter Primary.....	A-5509
Hydraulic Oil Filter.....	H-5510
Hydraulic Oil Filter.....	H-5503
D6H (DOZERS) S/N: 1FJ5500-5540	
Air Filter Primary.....	A-5509
Air Filter Set.....	A-5522-S
Air Filter Secondary.....	A-5522
Hydraulic Oil Filter.....	H-5503
Hydraulic Oil Filter.....	H-5510

MODEL/APPLICATION	SAKURA NO
CATERPILLAR	
D6H (DOZERS) S/N: 1FJ5541-5541	
Air Filter Primary.....	A-5549M
Air Filter Primary.....	A-5549
Air Filter Secondary.....	A-5550
Air Filter Set.....	A-5549M-S
Hydraulic Oil Filter.....	H-5510
Hydraulic Oil Filter.....	H-5503
D6H (DOZERS) S/N: 1FJ5542-UP	
Air Filter Set.....	A-5549M-S
Air Filter Secondary.....	A-5550
Air Filter Primary.....	A-5549
Air Filter Primary.....	A-5549M
Hydraulic Oil Filter.....	H-5503
Hydraulic Oil Filter.....	H-5510
D6H (DOZERS) S/N: 1KD1-5499	
Air Filter Primary.....	A-5549M
Air Filter Primary.....	A-5549
Air Filter Secondary.....	A-5550
Air Filter Set.....	A-5549M-S
Air Filter Secondary.....	A-5522
Air Filter Set.....	A-5522-S
Air Filter Primary.....	A-5509
Hydraulic Oil Filter.....	HC-55310
Hydraulic Oil Filter.....	H-5503
Oil Filter Full Flow.....	C-5510
D6H (DOZERS) S/N: 1KD1-UP	
Air Filter Primary.....	A-5509
Air Filter Set.....	A-5522-S
Air Filter Secondary.....	A-5522
Fuel Filter.....	F-5505
Fuel Filter Secondary.....	FC-5507
Hydraulic Oil Filter.....	H-5526
Hydraulic Oil Filter.....	H-55280
Hydraulic Oil Filter.....	HC-55310
Hydraulic Oil Filter.....	H-5503
Oil Filter Full Flow.....	C-5510
D6H (DOZERS) S/N: 1KD4074-UP	
Air Filter Secondary.....	A-5522
Air Filter Set.....	A-5522-S
Air Filter Primary.....	A-5509
Fuel Filter Secondary.....	FC-5507
Fuel Filter.....	F-5505
Hydraulic Oil Filter.....	H-5503
Hydraulic Oil Filter.....	H-55280
Hydraulic Oil Filter.....	H-5526
Hydraulic Oil Filter.....	H-5510
Oil Filter Full Flow.....	C-5510
D6H (DOZERS) S/N: 1KD5500-UP	
Air Filter Primary.....	A-5509
Air Filter Set.....	A-5522-S
Air Filter Secondary.....	A-5522
Air Filter Set.....	A-5549M-S

Sakura Filter

ENGINE APPLICATION

MODEL/APPLICATION	SAKURA NO	MODEL/APPLICATION	SAKURA NO	MODEL/APPLICATION	SAKURA NO
CATERPILLAR		CATERPILLAR		CATERPILLAR	
D6H (DOZERS) S/N: 1KD5500-UP Air Filter Secondary..... A-5550 Air Filter Primary..... A-5549 Air Filter Primary..... A-5549M Fuel Filter Secondary..... FC-5507 Hydraulic Oil Filter..... H-5503 Oil Filter Full Flow..... C-5510		Fuel Filter Secondary..... FC-5507 Hydraulic Oil Filter..... H-5503 Hydraulic Oil Filter..... H-5510 Hydraulic Oil Filter..... H-55280 Hydraulic Oil Filter..... H-5526 Oil Filter Full Flow..... C-5510 D6H (DOZERS) S/N: 3ED1-4082 Air Filter Set..... A-5522-S Air Filter Primary..... A-5509 Air Filter Secondary..... A-5522 Fuel Filter..... F-5505 Fuel Filter Secondary..... FC-5507 Hydraulic Oil Filter..... H-5526 Hydraulic Oil Filter..... H-55280 Hydraulic Oil Filter..... HC-55310 Hydraulic Oil Filter..... H-5503 Oil Filter Full Flow..... C-5510 D6H (DOZERS) S/N: 3ED4083-UP Air Filter Secondary..... A-5522 Air Filter Primary..... A-5509 Air Filter Set..... A-5522-S Fuel Filter..... F-5505 Fuel Filter Secondary..... FC-5507 Hydraulic Oil Filter..... H-5503 Hydraulic Oil Filter..... H-55280 Hydraulic Oil Filter..... H-5526 Hydraulic Oil Filter..... H-5510 Oil Filter Full Flow..... C-5510 D6H (DOZERS) S/N: 3ED4033-UP Air Filter Primary..... A-5509 Air Filter Set..... A-5522-S Air Filter Secondary..... A-5522 Fuel Filter..... F-5505 Fuel Filter Secondary..... FC-5507 Hydraulic Oil Filter..... H-55280 Hydraulic Oil Filter..... H-5526 Hydraulic Oil Filter..... H-5503 Hydraulic Oil Filter..... H-5510 Oil Filter Full Flow..... C-5510 D6H (DOZERS) S/N: 2KD5500-UP Air Filter Secondary..... A-5522 Air Filter Set..... A-5522-S Air Filter Primary..... A-5509 Fuel Filter..... F-5505 Fuel Filter Secondary..... FC-5507 Hydraulic Oil Filter..... H-5503 Hydraulic Oil Filter..... H-5510 Oil Filter Full Flow..... C-5510 D6H (DOZERS) S/N: 2TG1-3999 Air Filter Secondary..... A-5522 Air Filter Primary..... A-5509 Air Filter Set..... A-5522-S Fuel Filter..... F-5505 Fuel Filter Secondary..... FC-5507 Hydraulic Oil Filter..... H-5526 Hydraulic Oil Filter..... H-55280 Hydraulic Oil Filter..... HC-55310 Hydraulic Oil Filter..... H-5503 Oil Filter Full Flow..... C-5510 D6H (DOZERS) S/N: 2TG4000-UP Air Filter Primary..... A-5549M Air Filter Primary..... A-5549 Air Filter Secondary..... A-5550 Air Filter Set..... A-5549M-S Fuel Filter..... F-5505		Oil Filter Full Flow..... C-5510 D6H (DOZERS) S/N: 3YG4000-UP Air Filter Primary..... A-5549M Air Filter Primary..... A-5549 Air Filter Secondary..... A-5550 Air Filter Set..... A-5549M-S Fuel Filter..... F-5505 Fuel Filter Secondary..... FC-5507 Hydraulic Oil Filter..... H-5526 Hydraulic Oil Filter..... H-55280 Hydraulic Oil Filter..... H-5510 Oil Filter Full Flow..... C-5510 D6H (DOZERS) S/N: 3YG4255-4284 Air Filter Set..... A-5522-S Air Filter Primary..... A-5509 Air Filter Secondary..... A-5522 Hydraulic Oil Filter..... HC-55290 Hydraulic Oil Filter..... H-5510 Hydraulic Oil Filter..... H-55280 Hydraulic Oil Filter..... H-5526 D6H (DOZERS) S/N: 3YG4285-5499 Air Filter Secondary..... A-5522 Air Filter Primary..... A-5509 Air Filter Set..... A-5522-S Hydraulic Oil Filter..... H-5526 Hydraulic Oil Filter..... H-55280 Hydraulic Oil Filter..... H-5503 Hydraulic Oil Filter..... H-5510 Hydraulic Oil Filter..... HC-55290 D6H (DOZERS) S/N: 3YG5500-5733 Air Filter Set..... A-5549M-S Air Filter Secondary..... A-5550 Air Filter Primary..... A-5549 Air Filter Primary..... A-5549M Hydraulic Oil Filter..... HC-55290 Hydraulic Oil Filter..... H-5510 Hydraulic Oil Filter..... H-5503 Hydraulic Oil Filter..... H-5526 D6H (DOZERS) S/N: 3YG5734-UP Air Filter Primary..... A-5549M Air Filter Primary..... A-5549 Air Filter Secondary..... A-5550 Air Filter Set..... A-5549M-S Hydraulic Oil Filter..... H-5526 Hydraulic Oil Filter..... H-55280 Hydraulic Oil Filter..... H-5503 Hydraulic Oil Filter..... H-5510 Hydraulic Oil Filter..... HC-55290 D6H (DOZERS) S/N: 3ZF1-1319 Air Filter Set..... A-5522-S Air Filter Primary..... A-5509	

Sakura Filter

ENGINE APPLICATION

MODEL/APPLICATION	SAKURA NO	MODEL/APPLICATION	SAKURA NO	MODEL/APPLICATION	SAKURA NO
CATERPILLAR		CATERPILLAR		CATERPILLAR	
D6H (DOZERS) S/N: 3ZF1-1319 Air Filter Secondary..... A-5522 Hydraulic Oil Filter..... H-55280 Hydraulic Oil Filter..... H-5526		Air Filter Secondary..... A-5550 Air Filter Primary..... A-5549 Air Filter Primary..... A-5549M Hydraulic Oil Filter..... H-55280 Hydraulic Oil Filter..... H-5526 Hydraulic Oil Filter..... H-5503 Hydraulic Oil Filter..... HC-55290 Hydraulic Oil Filter..... H-5510		Hydraulic Oil Filter..... H-5510 Hydraulic Oil Filter..... HC-55310 Hydraulic Oil Filter..... H-55280 Hydraulic Oil Filter..... H-5526	
D6H (DOZERS) S/N: 3ZF1320-4382 Air Filter Secondary..... A-5522 Air Filter Primary..... A-5509 Air Filter Set..... A-5522-S Hydraulic Oil Filter..... H-5526 Hydraulic Oil Filter..... H-55280		D6H (DOZERS) S/N: 4GG1-UP Air Filter Set..... A-5522-S Air Filter Primary..... A-5509 Air Filter Secondary..... A-5522 Fuel Filter Secondary..... FC-5507 Fuel Filter..... F-5505 Hydraulic Oil Filter..... H-5526 Hydraulic Oil Filter..... H-55280 Hydraulic Oil Filter..... H-5510 Hydraulic Oil Filter..... H-5503 Oil Filter Full Flow..... C-5510		D6H (DOZERS) S/N: 4RC1-1049 Air Filter Set..... A-5522-S Air Filter Primary..... A-5509 Air Filter Secondary..... A-5522 Hydraulic Oil Filter..... HC-55310 Hydraulic Oil Filter..... H-5510	
D6H (DOZERS) S/N: 3ZF4000-UP Air Filter Set..... A-5549M-S Air Filter Secondary..... A-5550 Air Filter Primary..... A-5549 Air Filter Primary..... A-5549M Fuel Filter..... F-5505 Fuel Filter Secondary..... FC-5507 Hydraulic Oil Filter..... H-55280 Hydraulic Oil Filter..... H-5526 Hydraulic Oil Filter..... H-5503 Hydraulic Oil Filter..... H-5510 Oil Filter Full Flow..... C-5510		D6H (DOZERS) S/N: 4L600603-UP Air Filter Secondary..... A-5522 Air Filter Primary..... A-5509 Air Filter Set..... A-5522-S Fuel Filter Secondary..... FC-5507 Hydraulic Oil Filter..... H-5503 Hydraulic Oil Filter..... HC-55310 Oil Filter Full Flow..... C-5510		D6H (DOZERS) S/N: 4RC1-2444 Air Filter Secondary..... A-5522 Air Filter Primary..... A-5509 Air Filter Set..... A-5522-S Air Filter Set..... A-5549M-S Air Filter Secondary..... A-5550 Air Filter Primary..... A-5549 Air Filter Primary..... A-5549M Hydraulic Oil Filter..... H-5503 Hydraulic Oil Filter..... HC-55310 Oil Filter Full Flow..... C-5510	
D6H (DOZERS) S/N: 3ZF4383-4441 Air Filter Set..... A-5522-S Air Filter Primary..... A-5509 Air Filter Secondary..... A-5522 Hydraulic Oil Filter..... H-5526 Hydraulic Oil Filter..... H-55280 Hydraulic Oil Filter..... H-5510 Hydraulic Oil Filter..... HC-55290		D6H (DOZERS) S/N: 4L61-3999 Air Filter Set..... A-5522-S Air Filter Primary..... A-5509 Air Filter Secondary..... A-5522 Fuel Filter Secondary..... FC-5507 Fuel Filter..... F-5505 Hydraulic Oil Filter..... H-55280 Hydraulic Oil Filter..... H-5526 Hydraulic Oil Filter..... HC-55310 Hydraulic Oil Filter..... H-5503 Oil Filter Full Flow..... C-5510		D6H (DOZERS) S/N: 4RC2445-2550-UP Air Filter Set..... A-5522-S Air Filter Primary..... A-5509 Air Filter Secondary..... A-5522 Hydraulic Oil Filter..... HC-55310 Hydraulic Oil Filter..... H-5510 Hydraulic Oil Filter..... H-5526 Hydraulic Oil Filter..... H-55280	
D6H (DOZERS) S/N: 3ZF4442-5499 Air Filter Secondary..... A-5522 Air Filter Primary..... A-5509 Air Filter Set..... A-5522-S Hydraulic Oil Filter..... H-55280 Hydraulic Oil Filter..... H-5526 Hydraulic Oil Filter..... H-5503 Hydraulic Oil Filter..... HC-55290 Hydraulic Oil Filter..... H-5510		D6H (DOZERS) S/N: 4L64000-UP Air Filter Primary..... A-5549M Air Filter Primary..... A-5549 Air Filter Secondary..... A-5550 Air Filter Set..... A-5549M-S Fuel Filter..... F-5505 Fuel Filter Secondary..... FC-5507 Hydraulic Oil Filter..... H-5503 Hydraulic Oil Filter..... H-5526 Hydraulic Oil Filter..... H-55280 Hydraulic Oil Filter..... H-5510 Oil Filter Full Flow..... C-5510		D6H (DOZERS) S/N: 4RC2445-3999 Air Filter Secondary..... A-5522 Air Filter Primary..... A-5509 Air Filter Set..... A-5522-S Air Filter Primary..... A-5549M Air Filter Primary..... A-5549 Air Filter Secondary..... A-5550 Air Filter Set..... A-5549M-S Hydraulic Oil Filter..... H-5503 Oil Filter Full Flow..... C-5510	
D6H (DOZERS) S/N: 3ZF5500-5717 Air Filter Primary..... A-5549M Air Filter Primary..... A-5549 Air Filter Secondary..... A-5550 Air Filter Set..... A-5549M-S Hydraulic Oil Filter..... H-5503 Hydraulic Oil Filter..... H-5526 Hydraulic Oil Filter..... H-55280 Hydraulic Oil Filter..... H-5510 Hydraulic Oil Filter..... HC-55290		D6H (DOZERS) S/N: 4L64000-UP Air Filter Primary..... A-5549M Air Filter Primary..... A-5549 Air Filter Secondary..... A-5550 Air Filter Set..... A-5549M-S Fuel Filter..... F-5505 Fuel Filter Secondary..... FC-5507 Hydraulic Oil Filter..... H-5503 Hydraulic Oil Filter..... H-5526 Hydraulic Oil Filter..... H-55280 Hydraulic Oil Filter..... H-5510 Oil Filter Full Flow..... C-5510		D6H (DOZERS) S/N: 4RC2551-4050 Air Filter Set..... A-5522-S Air Filter Primary..... A-5509 Air Filter Secondary..... A-5522 Hydraulic Oil Filter..... H-5510 Hydraulic Oil Filter..... HC-55310 Hydraulic Oil Filter..... H-55280 Hydraulic Oil Filter..... H-5526	
D6H (DOZERS) S/N: 3ZF5718-UP Air Filter Set..... A-5549M-S		D6H (DOZERS) S/N: 4RC1050-2444 Air Filter Secondary..... A-5522 Air Filter Primary..... A-5509 Air Filter Set..... A-5522-S		D6H (DOZERS) S/N: 4RC4000-UP Air Filter Set..... A-5549M-S Air Filter Secondary..... A-5550 Air Filter Primary..... A-5549 Air Filter Primary..... A-5549M Fuel Filter..... F-5505	

MODEL/APPLICATION	SAKURA NO
CATERPILLAR	
D6H (DOZERS) S/N: 4RC4000-UP	
Fuel Filter Secondary.....	FC-5507
Hydraulic Oil Filter.....	H-5526
Hydraulic Oil Filter.....	H-55280
Hydraulic Oil Filter.....	H-5503
Hydraulic Oil Filter.....	H-5510
Oil Filter Full Flow.....	C-5510
D6H (DOZERS) S/N: 4RC4051-4217	
Air Filter Secondary.....	A-5522
Air Filter Primary.....	A-5509
Air Filter Set.....	A-5522-S
Hydraulic Oil Filter.....	H-5510
Hydraulic Oil Filter.....	HC-55310
Hydraulic Oil Filter.....	H-5503
Hydraulic Oil Filter.....	H-55280
Hydraulic Oil Filter.....	H-5526
D6H (DOZERS) S/N: 4RC4218-4302	
Air Filter Set.....	A-5522-S
Air Filter Primary.....	A-5509
Air Filter Secondary.....	A-5522
Hydraulic Oil Filter.....	H-5526
Hydraulic Oil Filter.....	H-55280
Hydraulic Oil Filter.....	HC-55310
Hydraulic Oil Filter.....	H-5510
D6H (DOZERS) S/N: 4RC4303-5499	
Air Filter Secondary.....	A-5522
Air Filter Primary.....	A-5509
Air Filter Set.....	A-5522-S
Hydraulic Oil Filter.....	H-5510
Hydraulic Oil Filter.....	HC-55310
Hydraulic Oil Filter.....	H-55280
Hydraulic Oil Filter.....	H-5526
Hydraulic Oil Filter.....	H-5503
D6H (DOZERS) S/N: 4RC5500-UP	
Air Filter Primary.....	A-5549M
Air Filter Primary.....	A-5549
Air Filter Secondary.....	A-5550
Air Filter Set.....	A-5549M-S
Hydraulic Oil Filter.....	H-5503
Hydraulic Oil Filter.....	H-5526
Hydraulic Oil Filter.....	H-55280
Hydraulic Oil Filter.....	HC-55310
Hydraulic Oil Filter.....	H-5510
D6H (DOZERS) S/N: 4RD1-3999	
Air Filter Set.....	A-5522-S
Air Filter Primary.....	A-5509
Air Filter Secondary.....	A-5522
Fuel Filter Secondary.....	FC-5507
Fuel Filter.....	F-5505
Hydraulic Oil Filter.....	H-55280
Hydraulic Oil Filter.....	H-5526
Hydraulic Oil Filter.....	HC-55310
Hydraulic Oil Filter.....	H-5503

MODEL/APPLICATION	SAKURA NO
CATERPILLAR	
Hydraulic Oil Filter.....	H-5510
Hydraulic Oil Filter.....	HC-55310
Oil Filter Full Flow.....	C-5510
D6H (DOZERS) S/N: 4YF1-UP	
Air Filter Secondary.....	A-5522
Air Filter Primary.....	A-5509
Air Filter Set.....	A-5522-S
Fuel Filter Secondary.....	FC-5507
Fuel Filter.....	F-5505
Hydraulic Oil Filter.....	H-5510
Hydraulic Oil Filter.....	H-5503
Hydraulic Oil Filter.....	H-5526
Hydraulic Oil Filter.....	H-55280
Oil Filter Full Flow.....	C-5510
D6H (DOZERS) S/N: 4YF5500-UP	
Air Filter Set.....	A-5522-S
Air Filter Primary.....	A-5509
Fuel Filter.....	F-5505
Hydraulic Oil Filter.....	H-5510
Hydraulic Oil Filter.....	H-5503
Oil Filter Full Flow.....	C-5510
D6H (DOZERS) S/N: 5HF1-3999	
Air Filter Primary.....	A-5509
Air Filter Set.....	A-5522-S
Air Filter Secondary.....	A-5522
Fuel Filter.....	F-5505
Fuel Filter Secondary.....	FC-5507
Hydraulic Oil Filter.....	H-55280
Hydraulic Oil Filter.....	H-5526
Hydraulic Oil Filter.....	H-5510
Hydraulic Oil Filter.....	H-5503
Oil Filter Full Flow.....	C-5510
D6H (DOZERS) S/N: 5HF1-4159	
Air Filter Secondary.....	A-5522
Air Filter Set.....	A-5522-S
Air Filter Primary.....	A-5509
Hydraulic Oil Filter.....	H-5510
Hydraulic Oil Filter.....	HC-55290
Hydraulic Oil Filter.....	H-5503
D6H (DOZERS) S/N: 5HF4000-UP	
Air Filter Secondary.....	A-5522
Air Filter Set.....	A-5522-S
Air Filter Primary.....	A-5509
Hydraulic Oil Filter.....	H-5510
Hydraulic Oil Filter.....	HC-55290
Hydraulic Oil Filter.....	H-5503
D6H (DOZERS) S/N: 5HF4160-5513	
Air Filter Primary.....	A-5509

MODEL/APPLICATION	SAKURA NO
CATERPILLAR	
Air Filter Set.....	A-5522-S
Air Filter Secondary.....	A-5522
Hydraulic Oil Filter.....	H-5510
Hydraulic Oil Filter.....	HC-55290
Hydraulic Oil Filter.....	H-5503
D6H (DOZERS) S/N: 5HF5514-UP	
Air Filter Primary.....	A-5549M
Air Filter Primary.....	A-5549
Air Filter Secondary.....	A-5550
Air Filter Set.....	A-5549M-S
Hydraulic Oil Filter.....	H-5503
Hydraulic Oil Filter.....	HC-55290
Hydraulic Oil Filter.....	H-5510
D6H (DOZERS) S/N: 6CF1-3999	
Air Filter Secondary.....	A-5522
Air Filter Set.....	A-5522-S
Air Filter Primary.....	A-5509
Fuel Filter Secondary.....	FC-5507
Fuel Filter.....	F-5505
Hydraulic Oil Filter.....	H-5503
Hydraulic Oil Filter.....	H-55280
Hydraulic Oil Filter.....	H-5526
Hydraulic Oil Filter.....	H-5510
Oil Filter Full Flow.....	C-5510
D6H (DOZERS) S/N: 6CF1-4159	
Air Filter Primary.....	A-5509
Air Filter Set.....	A-5522-S
Air Filter Secondary.....	A-5522
Hydraulic Oil Filter.....	H-5510
Hydraulic Oil Filter.....	HC-55290
Hydraulic Oil Filter.....	H-5503
D6H (DOZERS) S/N: 6CF4000-UP	
Air Filter Set.....	A-5549M-S
Air Filter Secondary.....	A-5550
Air Filter Primary.....	A-5549
Air Filter Primary.....	A-5549M
Fuel Filter Secondary.....	FC-5507
Fuel Filter.....	F-5505
Hydraulic Oil Filter.....	H-5510
Hydraulic Oil Filter.....	H-5503
Hydraulic Oil Filter.....	H-5526
Hydraulic Oil Filter.....	H-55280
Oil Filter Full Flow.....	C-5510
D6H (DOZERS) S/N: 6CF4160-5533	
Air Filter Secondary.....	A-5522
Air Filter Set.....	A-5522-S
Air Filter Primary.....	A-5509
Hydraulic Oil Filter.....	H-5510
Hydraulic Oil Filter.....	HC-55290
Hydraulic Oil Filter.....	H-5503
D6H (DOZERS) S/N: 6CF5534-UP	
Air Filter Primary.....	A-5549M

MODEL/APPLICATION	SAKURA NO
CATERPILLAR	
D6H (DOZERS) S/N: 6CF5534-UP	
Air Filter Primary.....	A-5549
Air Filter Secondary.....	A-5550
Air Filter Set.....	A-5549M-S
Hydraulic Oil Filter.....	HC-55290
Hydraulic Oil Filter.....	H-5510
Hydraulic Oil Filter.....	H-5503
D6H (DOZERS) S/N: 6FC1-355	
Air Filter Primary.....	A-5509
Air Filter Set.....	A-5522-S
Air Filter Secondary.....	A-5522
Hydraulic Oil Filter.....	H-5510
Hydraulic Oil Filter.....	HC-55310
D6H (DOZERS) S/N: 6FC1-3999	
Air Filter Secondary.....	A-5522
Air Filter Set.....	A-5522-S
Air Filter Primary.....	A-5509
Fuel Filter.....	F-5505
Fuel Filter Secondary.....	FC-5507
Hydraulic Oil Filter.....	H-55280
Hydraulic Oil Filter.....	H-5526
Hydraulic Oil Filter.....	HC-55310
Hydraulic Oil Filter.....	H-5510
Hydraulic Oil Filter.....	H-5503
Oil Filter Full Flow.....	C-5510
D6H (DOZERS) S/N: 6FC1-UP	
Air Filter Primary.....	A-5509
Air Filter Set.....	A-5522-S
Air Filter Secondary.....	A-5522
Hydraulic Oil Filter.....	H-5503
Oil Filter Full Flow.....	C-5510
D6H (DOZERS) S/N: 6FC4000-UP	
Air Filter Set.....	A-5549M-S
Air Filter Secondary.....	A-5550
Air Filter Primary.....	A-5549
Air Filter Primary.....	A-5549M
Fuel Filter.....	F-5505
Fuel Filter Secondary.....	FC-5507
Hydraulic Oil Filter.....	H-55280
Hydraulic Oil Filter.....	H-5526
Hydraulic Oil Filter.....	H-5503
Hydraulic Oil Filter.....	HC-55310
Hydraulic Oil Filter.....	H-5510
Oil Filter Full Flow.....	C-5510

MODEL/APPLICATION	SAKURA NO
CATERPILLAR	
D6H (DOZERS) S/N: 6FC4034-4076	
Air Filter Primary.....	A-5509
Air Filter Set.....	A-5522-S
Air Filter Secondary.....	A-5522
Hydraulic Oil Filter.....	H-5510
Hydraulic Oil Filter.....	HC-55310
Hydraulic Oil Filter.....	H-5503
Hydraulic Oil Filter.....	H-5526
Hydraulic Oil Filter.....	H-55280
D6H (DOZERS) S/N: 6FC4077-4088	
Air Filter Secondary.....	A-5522
Air Filter Set.....	A-5522-S
Air Filter Primary.....	A-5509
Hydraulic Oil Filter.....	H-55280
Hydraulic Oil Filter.....	H-5526
Hydraulic Oil Filter.....	HC-55310
Hydraulic Oil Filter.....	H-5510
D6H (DOZERS) S/N: 6FC4089-5499	
Air Filter Primary.....	A-5509
Air Filter Set.....	A-5522-S
Air Filter Secondary.....	A-5522
Hydraulic Oil Filter.....	H-5510
Hydraulic Oil Filter.....	HC-55310
Hydraulic Oil Filter.....	H-5526
Hydraulic Oil Filter.....	H-55280
Hydraulic Oil Filter.....	H-5503
D6H (DOZERS) S/N: 6FC5500-UP	
Air Filter Primary.....	A-5549M
Air Filter Primary.....	A-5549
Air Filter Secondary.....	A-5550
Air Filter Set.....	A-5549M-S
Hydraulic Oil Filter.....	H-5503
Hydraulic Oil Filter.....	H-55280
Hydraulic Oil Filter.....	H-5526
Hydraulic Oil Filter.....	HC-55310
Hydraulic Oil Filter.....	H-5510
D6H (DOZERS) S/N: 6FC692-4033	
Air Filter Secondary.....	A-5522
Air Filter Set.....	A-5522-S
Air Filter Primary.....	A-5509
Hydraulic Oil Filter.....	H-5510
Hydraulic Oil Filter.....	HC-55310
Hydraulic Oil Filter.....	H-5526
Hydraulic Oil Filter.....	H-55280
D6H (DOZERS) S/N: 7PC1-UP	
Air Filter Primary.....	A-5509
Air Filter Set.....	A-5522-S
Air Filter Secondary.....	A-5522
Fuel Filter Secondary.....	FC-5507
Fuel Filter.....	F-5505
Hydraulic Oil Filter.....	HC-55310
Hydraulic Oil Filter.....	H-55280

MODEL/APPLICATION	SAKURA NO
CATERPILLAR	
Hydraulic Oil Filter.....	H-5526
Hydraulic Oil Filter.....	H-5503
Oil Filter Full Flow.....	C-5510
D6H (DOZERS) S/N: 8FC1-UP	
Air Filter Secondary.....	A-5522
Air Filter Set.....	A-5522-S
Air Filter Primary.....	A-5509
Fuel Filter.....	F-5505
Fuel Filter Secondary.....	FC-5507
Hydraulic Oil Filter.....	H-5503
Hydraulic Oil Filter.....	H-5526
Hydraulic Oil Filter.....	H-55280
Hydraulic Oil Filter.....	HC-55310
Oil Filter Full Flow.....	C-5510
D6H (DOZERS) S/N: 8FC4092-UP	
Air Filter Primary.....	A-5509
Air Filter Set.....	A-5522-S
Air Filter Secondary.....	A-5522
Fuel Filter Secondary.....	FC-5507
Fuel Filter.....	F-5505
Hydraulic Oil Filter.....	H-5510
Hydraulic Oil Filter.....	H-55280
Hydraulic Oil Filter.....	H-5526
Hydraulic Oil Filter.....	H-5503
Oil Filter Full Flow.....	C-5510
D6H (DOZERS) S/N: 8FC5500-UP	
Air Filter Secondary.....	A-5522
Air Filter Set.....	A-5522-S
Air Filter Primary.....	A-5509
Fuel Filter Secondary.....	FC-5507
Hydraulic Oil Filter.....	H-5503
Hydraulic Oil Filter.....	H-5510
Oil Filter Full Flow.....	C-5510
D6H (DOZERS) S/N: 8KB1-440	
Air Filter Primary.....	A-5509
Air Filter Set.....	A-5522-S
Air Filter Secondary.....	A-5522
Hydraulic Oil Filter.....	HC-55310
D6H (DOZERS) S/N: 8KB1-UP	
Air Filter Secondary.....	A-5522
Air Filter Set.....	A-5522-S
Air Filter Primary.....	A-5509
Fuel Filter Secondary.....	FC-5507
Fuel Filter.....	F-5505
Hydraulic Oil Filter.....	HC-55310
Hydraulic Oil Filter.....	H-5526
Hydraulic Oil Filter.....	H-55280
Hydraulic Oil Filter.....	H-5503
Oil Filter Full Flow.....	C-5510
D6H (DOZERS) S/N: 8YC1-UP	
Air Filter Primary.....	A-5509
Air Filter Set.....	A-5522-S
Air Filter Secondary.....	A-5522

Sakura Filter

ENGINE APPLICATION

MODEL/APPLICATION	SAKURA NO	MODEL/APPLICATION	SAKURA NO	MODEL/APPLICATION	SAKURA NO
CATERPILLAR		CATERPILLAR		CATERPILLAR	
D6H LGP SERIES II (DOZERS) S/N: 4YF5500-UP , T0-2001 Hydraulic Oil Filter..... H-5503 Hydraulic Oil Filter..... H-5526 Hydraulic Oil Filter..... H-55280 Hydraulic Oil Filter..... H-5510 Oil Filter Full Flow..... C-5510		Oil Filter Full Flow..... C-5510 D6H LGP SERIES II (DOZERS) S/N: 3YG4000-UP Air Filter Set..... A-5549M-S Air Filter Primary..... A-5549 Air Filter Secondary..... A-5550 Air Filter Primary..... A-5549M Fuel Filter Secondary..... FC-5507 Fuel Filter..... F-5505 Hydraulic Oil Filter..... H-5510 Hydraulic Oil Filter..... H-5503 Hydraulic Oil Filter..... H-5526 Hydraulic Oil Filter..... H-55280 Oil Filter Full Flow..... C-5510		Fuel Filter..... F-5505 Hydraulic Oil Filter..... H-5510 Hydraulic Oil Filter..... H-5503 Hydraulic Oil Filter..... H-5526 Hydraulic Oil Filter..... H-55280 Oil Filter Full Flow..... C-5510 D6H LGP SERIES II (DOZERS) S/N: 5HF4000-UP Air Filter Set..... A-5549M-S Air Filter Primary..... A-5549 Air Filter Secondary..... A-5550 Air Filter Primary..... A-5549M Fuel Filter..... F-5505 Fuel Filter Secondary..... FC-5507 Hydraulic Oil Filter..... H-5503 Hydraulic Oil Filter..... H-55280 Hydraulic Oil Filter..... H-5526 Hydraulic Oil Filter..... H-5510 Oil Filter Full Flow..... C-5510	
D6H LGP SERIES II (DOZERS) CAT 3306 Cabin Air Filter..... CA-55140		D6H LGP SERIES II (DOZERS) S/N: 1KD4074-UP Air Filter Secondary..... A-5522 Air Filter Set..... A-5522-S Air Filter Primary..... A-5509 Fuel Filter Secondary..... FC-5507 Fuel Filter..... F-5505 Hydraulic Oil Filter..... H-5503 Hydraulic Oil Filter..... H-5526 Hydraulic Oil Filter..... H-55280 Hydraulic Oil Filter..... H-5510 Oil Filter Full Flow..... C-5510		D6H LGP SERIES II (DOZERS) S/N: 6CF4000-UP Air Filter Primary..... A-5549M Air Filter Secondary..... A-5550 Air Filter Primary..... A-5549 Air Filter Set..... A-5549M-S Fuel Filter Secondary..... FC-5507 Fuel Filter..... F-5505 Hydraulic Oil Filter..... H-5526 Hydraulic Oil Filter..... H-55280 Hydraulic Oil Filter..... H-5510 Oil Filter Full Flow..... C-5510	
D6H LGP SERIES II (DOZERS) S/N: 2KD4033-UP Air Filter Secondary..... A-5522 Air Filter Primary..... A-5509 Air Filter Set..... A-5522-S Fuel Filter..... F-5505 Fuel Filter Secondary..... FC-5507 Hydraulic Oil Filter..... H-5510 Hydraulic Oil Filter..... H-55280 Hydraulic Oil Filter..... H-5526 Hydraulic Oil Filter..... H-5503 Oil Filter Full Flow..... C-5510		D6H LGP SERIES II (DOZERS) S/N: 4GG5500-UP Air Filter Primary..... A-5509 Air Filter Set..... A-5522-S Air Filter Secondary..... A-5522 Fuel Filter Secondary..... FC-5507 Fuel Filter..... F-5505 Hydraulic Oil Filter..... H-5510 Hydraulic Oil Filter..... H-5503 Hydraulic Oil Filter..... H-5526 Hydraulic Oil Filter..... H-55280 Oil Filter Full Flow..... C-5510		D6H LGP SERIES II (DOZERS) S/N: 6FC4000-UP Air Filter Primary..... A-5549M Air Filter Set..... A-5549M-S Air Filter Primary..... A-5549 Air Filter Secondary..... A-5550 Fuel Filter..... F-5505 Fuel Filter Secondary..... FC-5507 Hydraulic Oil Filter..... H-5503 Hydraulic Oil Filter..... H-55280 Hydraulic Oil Filter..... H-5526 Hydraulic Oil Filter..... HC-55310 Hydraulic Oil Filter..... H-5510 Oil Filter Full Flow..... C-5510	
D6H LGP SERIES II (DOZERS) S/N: 2TG4000-UP Air Filter Primary..... A-5549M Air Filter Set..... A-5549M-S Air Filter Secondary..... A-5550 Air Filter Primary..... A-5549 Fuel Filter Secondary..... FC-5507 Fuel Filter..... F-5505 Hydraulic Oil Filter..... H-5503 Hydraulic Oil Filter..... H-5526 Hydraulic Oil Filter..... H-55280 Hydraulic Oil Filter..... H-5510 Oil Filter Full Flow..... C-5510		D6H LGP SERIES II (DOZERS) S/N: 4LG4000-UP Air Filter Set..... A-5549M-S Air Filter Primary..... A-5549 Air Filter Secondary..... A-5550 Air Filter Primary..... A-5549M Fuel Filter..... F-5505 Fuel Filter Secondary..... FC-5507 Hydraulic Oil Filter..... H-5510 Hydraulic Oil Filter..... H-55280 Hydraulic Oil Filter..... H-5526 Hydraulic Oil Filter..... H-5503 Oil Filter Full Flow..... C-5510		D6H LGP SERIES II (DOZERS) S/N: 8FC5500-UP Air Filter Secondary..... A-5522 Air Filter Set..... A-5522-S Air Filter Primary..... A-5509 Fuel Filter Secondary..... FC-5507 Fuel Filter..... F-5505 Hydraulic Oil Filter..... H-5510 Hydraulic Oil Filter..... H-5526 Hydraulic Oil Filter..... H-55280 Hydraulic Oil Filter..... H-5503 Oil Filter Full Flow..... C-5510	
D6H LGP SERIES II (DOZERS) S/N: 2TL1-UP Air Filter Set..... A-5522-S Air Filter Primary..... A-5509 Air Filter Secondary..... A-5522 Fuel Filter..... F-5505 Fuel Filter Secondary..... FC-5507 Hydraulic Oil Filter..... H-5510 Hydraulic Oil Filter..... H-55280 Hydraulic Oil Filter..... H-5526 Hydraulic Oil Filter..... H-5503		D6H LGP SERIES II (DOZERS) S/N: 4RC4000-UP Air Filter Primary..... A-5549M Air Filter Secondary..... A-5550 Air Filter Primary..... A-5549 Air Filter Set..... A-5549M-S Fuel Filter Secondary..... FC-5507			

MODEL/APPLICATION	SAKURA NO
-------------------	-----------

CATERPILLAR

**D6H LGP SERIES II
(DOZERS)
S/N: 85K1-UP**

Air Filter Primary.....	A-5509
Air Filter Set.....	A-5522-S
Air Filter Secondary.....	A-5522
Fuel Filter Secondary.....	FC-5507
Fuel Filter.....	F-5505
Hydraulic Oil Filter.....	H-5503
Hydraulic Oil Filter.....	H-55280
Hydraulic Oil Filter.....	H-5526
Hydraulic Oil Filter.....	H-5510
Oil Filter Full Flow.....	C-5510

**D6H LS
(DOZERS)**

Air Filter Primary.....	A-5509
Air Filter Set.....	A-5522-S
Air Filter Secondary.....	A-5522
Air Filter Primary.....	A-5549M
Air Filter Primary.....	A-5549
Air Filter Secondary.....	A-5550
Air Filter Set.....	A-5549M-S
Fuel Filter.....	FC-5501
Fuel Filter Secondary.....	FC-5507
Hydraulic Oil Filter.....	H-5510
Hydraulic Oil Filter.....	H-5503
Oil Filter Full Flow.....	C-5510

**D6H LS SERIES II
(DOZERS)
S/N: 2DK5500-UP**

Air Filter Secondary.....	A-5522
Air Filter Set.....	A-5522-S
Air Filter Primary.....	A-5509
Fuel Filter Secondary.....	FC-5507
Fuel Filter.....	F-5505
Hydraulic Oil Filter.....	H-5503
Hydraulic Oil Filter.....	H-5510
Hydraulic Oil Filter.....	H-55280
Hydraulic Oil Filter.....	H-5526
Oil Filter Full Flow.....	C-5510

**D6H SERIES II
(DOZERS)
S/N: 1FJ1-481**

Air Filter Secondary.....	A-5522
Air Filter Primary.....	A-5509
Air Filter Set.....	A-5522-S
Hydraulic Oil Filter.....	H-5503

**D6H SERIES II
(DOZERS)
S/N: 1FJ4000-5499**

Air Filter Set.....	A-5522-S
Air Filter Primary.....	A-5509
Air Filter Secondary.....	A-5522
Hydraulic Oil Filter.....	H-5503
Hydraulic Oil Filter.....	H-5510

**D6H SERIES II
(DOZERS)
S/N: 1FJ4000-UP**

Air Filter Set.....	A-5549M-S
Air Filter Secondary.....	A-5550
Air Filter Primary.....	A-5549
Air Filter Primary.....	A-5549M
Fuel Filter.....	F-5505

MODEL/APPLICATION	SAKURA NO
-------------------	-----------

CATERPILLAR

Fuel Filter Secondary.....	FC-5507
Hydraulic Oil Filter.....	H-5526
Hydraulic Oil Filter.....	H-55280
Hydraulic Oil Filter.....	H-5510
Hydraulic Oil Filter.....	H-5503
Oil Filter Full Flow.....	C-5510

**D6H SERIES II
(DOZERS)
S/N: 1FJ482-3999**

Air Filter Secondary.....	A-5522
Air Filter Primary.....	A-5509
Air Filter Set.....	A-5522-S
Hydraulic Oil Filter.....	H-5503
Hydraulic Oil Filter.....	H-5510

**D6H SERIES II
(DOZERS)
S/N: 1FJ5500-5540**

Air Filter Set.....	A-5522-S
Air Filter Primary.....	A-5509
Air Filter Secondary.....	A-5522
Hydraulic Oil Filter.....	H-5510
Hydraulic Oil Filter.....	H-5503

**D6H SERIES II
(DOZERS)
S/N: 1FJ5541-5541**

Air Filter Set.....	A-5549M-S
Air Filter Primary.....	A-5549M
Air Filter Primary.....	A-5549
Air Filter Secondary.....	A-5550
Hydraulic Oil Filter.....	H-5503
Hydraulic Oil Filter.....	H-5510

**D6H SERIES II
(DOZERS)
S/N: 1FJ5542-UP**

Air Filter Secondary.....	A-5550
Air Filter Primary.....	A-5549
Air Filter Primary.....	A-5549M
Air Filter Set.....	A-5549M-S
Hydraulic Oil Filter.....	H-5510
Hydraulic Oil Filter.....	H-5503

**D6H SERIES II
(DOZERS)
S/N: 1YL1-318**

Air Filter Primary.....	A-5549M
Air Filter Primary.....	A-5549
Air Filter Secondary.....	A-5550
Air Filter Set.....	A-5549M-S
Air Filter Secondary.....	A-5522
Air Filter Primary.....	A-5509
Air Filter Set.....	A-5522-S
Hydraulic Oil Filter.....	H-5503
Hydraulic Oil Filter.....	HC-55290
Hydraulic Oil Filter.....	H-5510

**D6H SERIES II
(DOZERS)
S/N: 1YL319-UP**

Air Filter Set.....	A-5549M-S
Air Filter Secondary.....	A-5550
Air Filter Primary.....	A-5549
Air Filter Primary.....	A-5549M
Hydraulic Oil Filter.....	H-5510
Hydraulic Oil Filter.....	HC-55290
Hydraulic Oil Filter.....	H-5503

MODEL/APPLICATION	SAKURA NO
-------------------	-----------

CATERPILLAR

**D6H SERIES II
(DOZERS)
S/N: 2BL1-343**

Air Filter Primary.....	A-5549M
Air Filter Primary.....	A-5549
Air Filter Secondary.....	A-5550
Air Filter Set.....	A-5549M-S
Air Filter Secondary.....	A-5522
Air Filter Set.....	A-5522-S
Air Filter Primary.....	A-5509
Hydraulic Oil Filter.....	H-5503
Hydraulic Oil Filter.....	H-5510

**D6H SERIES II
(DOZERS)
S/N: 2BL344-UP**

Air Filter Primary.....	A-5509
Air Filter Set.....	A-5522-S
Air Filter Secondary.....	A-5522
Air Filter Set.....	A-5549M-S
Air Filter Secondary.....	A-5550
Air Filter Primary.....	A-5549
Air Filter Primary.....	A-5549M
Hydraulic Oil Filter.....	H-5510
Hydraulic Oil Filter.....	H-5503

**D6H SERIES II
(DOZERS)
S/N: 2DK1-UP**

Air Filter Secondary.....	A-5522
Air Filter Set.....	A-5522-S
Air Filter Primary.....	A-5509
Fuel Filter Secondary.....	FC-5507
Fuel Filter.....	F-5505
Hydraulic Oil Filter.....	H-5510
Hydraulic Oil Filter.....	H-55280
Hydraulic Oil Filter.....	H-5526
Hydraulic Oil Filter.....	H-5503
Oil Filter Full Flow.....	C-5510

**D6H SERIES II
(DOZERS)
S/N: 2TG1-524**

Air Filter Secondary.....	A-5522
Air Filter Primary.....	A-5509
Air Filter Set.....	A-5522-S
Hydraulic Oil Filter.....	H-5503

**D6H SERIES II
(DOZERS)
S/N: 2TG4000-4094**

Air Filter Set.....	A-5522-S
Air Filter Primary.....	A-5509
Air Filter Secondary.....	A-5522
Hydraulic Oil Filter.....	H-5503
Hydraulic Oil Filter.....	H-5510

**D6H SERIES II
(DOZERS)
S/N: 2TG495-5499**

Air Filter Secondary.....	A-5522
Air Filter Primary.....	A-5509
Air Filter Set.....	A-5522-S
Hydraulic Oil Filter.....	H-5510
Hydraulic Oil Filter.....	H-5503

**D6H SERIES II
(DOZERS)
S/N: 2TG525-3999**

Air Filter Set.....	A-5522-S
Air Filter Primary.....	A-5509

MODEL/APPLICATION	SAKURA NO	MODEL/APPLICATION	SAKURA NO	MODEL/APPLICATION	SAKURA NO
CATERPILLAR		CATERPILLAR		CATERPILLAR	
D6H SERIES II (DOZERS) S/N: 2TG525-3999 Air Filter Secondary..... A-5522 Hydraulic Oil Filter..... H-5503 Hydraulic Oil Filter..... H-5510		Air Filter Secondary..... A-5550 Air Filter Set..... A-5549M-S Hydraulic Oil Filter..... H-5503 Hydraulic Oil Filter..... HC-55290 Hydraulic Oil Filter..... H-5510 Hydraulic Oil Filter..... H-55280 Hydraulic Oil Filter..... H-5526		Hydraulic Oil Filter..... H-5503 Hydraulic Oil Filter..... HC-55290 Hydraulic Oil Filter..... H-5510 D6H SERIES II (DOZERS) S/N: 3ZF5718-UP Air Filter Set..... A-5549M-S Air Filter Secondary..... A-5550 Air Filter Primary..... A-5549 Air Filter Primary..... A-5549M Hydraulic Oil Filter..... H-5526 Hydraulic Oil Filter..... H-55280 Hydraulic Oil Filter..... H-5510 Hydraulic Oil Filter..... HC-55290 Hydraulic Oil Filter..... H-5503	
D6H SERIES II (DOZERS) S/N: 2TG5500-5587 Air Filter Secondary..... A-5522 Air Filter Primary..... A-5509 Air Filter Set..... A-5522-S Hydraulic Oil Filter..... H-5510 Hydraulic Oil Filter..... H-5503		D6H SERIES II (DOZERS) S/N: 3YG5734-UP Air Filter Set..... A-5549M-S Air Filter Secondary..... A-5550 Air Filter Primary..... A-5549 Air Filter Primary..... A-5549M Hydraulic Oil Filter..... H-5526 Hydraulic Oil Filter..... H-55280 Hydraulic Oil Filter..... H-5510 Hydraulic Oil Filter..... H-5503		D6H SERIES II (DOZERS) S/N: 4LG1-934 Air Filter Secondary..... A-5522 Air Filter Primary..... A-5509 Air Filter Set..... A-5522-S Hydraulic Oil Filter..... H-5503	
D6H SERIES II (DOZERS) S/N: 2TG5588-5592 Air Filter Set..... A-5549M-S Air Filter Primary..... A-5549M Air Filter Primary..... A-5549 Air Filter Secondary..... A-5550 Hydraulic Oil Filter..... H-5503 Hydraulic Oil Filter..... H-5510		D6H SERIES II (DOZERS) S/N: 3ZF1-1319 Air Filter Secondary..... A-5522 Air Filter Primary..... A-5509 Air Filter Set..... A-5522-S Hydraulic Oil Filter..... H-55280 Hydraulic Oil Filter..... H-5526		D6H SERIES II (DOZERS) S/N: 4LG4000-4410 Air Filter Set..... A-5522-S Air Filter Primary..... A-5509 Air Filter Secondary..... A-5522 Hydraulic Oil Filter..... H-5503 Hydraulic Oil Filter..... H-5510	
D6H SERIES II (DOZERS) S/N: 2TG5593-UP Air Filter Secondary..... A-5550 Air Filter Primary..... A-5549 Air Filter Primary..... A-5549M Air Filter Set..... A-5549M-S Hydraulic Oil Filter..... H-5510 Hydraulic Oil Filter..... H-5503		D6H SERIES II (DOZERS) S/N: 3ZF1320-4382 Air Filter Set..... A-5522-S Air Filter Primary..... A-5509 Air Filter Secondary..... A-5522 Hydraulic Oil Filter..... H-5526 Hydraulic Oil Filter..... H-55280		D6H SERIES II (DOZERS) S/N: 4LG4411-5499 Air Filter Secondary..... A-5522 Air Filter Primary..... A-5509 Air Filter Set..... A-5522-S Hydraulic Oil Filter..... H-5510 Hydraulic Oil Filter..... H-5503	
D6H SERIES II (DOZERS) S/N: 3YG1-4254 Air Filter Secondary..... A-5522 Air Filter Set..... A-5522-S Air Filter Primary..... A-5509 Hydraulic Oil Filter..... H-5526 Hydraulic Oil Filter..... H-55280		D6H SERIES II (DOZERS) S/N: 3ZF4383-4441 Air Filter Secondary..... A-5522 Air Filter Primary..... A-5509 Air Filter Set..... A-5522-S Hydraulic Oil Filter..... H-55280 Hydraulic Oil Filter..... H-5526 Hydraulic Oil Filter..... HC-55290 Hydraulic Oil Filter..... H-5510		D6H SERIES II (DOZERS) S/N: 4LG5500-5536 Air Filter Set..... A-5522-S Air Filter Primary..... A-5509 Air Filter Secondary..... A-5522 Hydraulic Oil Filter..... H-5503 Hydraulic Oil Filter..... H-5510	
D6H SERIES II (DOZERS) S/N: 3YG4255-4284 Air Filter Primary..... A-5509 Air Filter Set..... A-5522-S Air Filter Secondary..... A-5522 Hydraulic Oil Filter..... HC-55290 Hydraulic Oil Filter..... H-5510 Hydraulic Oil Filter..... H-55280 Hydraulic Oil Filter..... H-5526		D6H SERIES II (DOZERS) S/N: 3ZF4442-5499 Air Filter Set..... A-5522-S Air Filter Primary..... A-5509 Air Filter Secondary..... A-5522 Hydraulic Oil Filter..... H-5526 Hydraulic Oil Filter..... H-55280 Hydraulic Oil Filter..... H-5510 Hydraulic Oil Filter..... HC-55290 Hydraulic Oil Filter..... H-5503		D6H SERIES II (DOZERS) S/N: 4LG5537-5592 Air Filter Set..... A-5549M-S Air Filter Primary..... A-5549M Air Filter Primary..... A-5549 Air Filter Secondary..... A-5550 Hydraulic Oil Filter..... H-5510 Hydraulic Oil Filter..... H-5503	
D6H SERIES II (DOZERS) S/N: 3YG4285-5499 Air Filter Secondary..... A-5522 Air Filter Set..... A-5522-S Air Filter Primary..... A-5509 Hydraulic Oil Filter..... H-5526 Hydraulic Oil Filter..... H-55280 Hydraulic Oil Filter..... H-5510 Hydraulic Oil Filter..... HC-55290 Hydraulic Oil Filter..... H-5503		D6H SERIES II (DOZERS) S/N: 3ZF5500-5717 Air Filter Primary..... A-5549M Air Filter Primary..... A-5549 Air Filter Secondary..... A-5550 Air Filter Set..... A-5549M-S Hydraulic Oil Filter..... H-55280 Hydraulic Oil Filter..... H-5526		D6H SERIES II (DOZERS) S/N: 4LG5593-UP Air Filter Secondary..... A-5550 Air Filter Primary..... A-5549 Air Filter Primary..... A-5549M Air Filter Set..... A-5549M-S Hydraulic Oil Filter..... H-5503 Hydraulic Oil Filter..... H-5510	
D6H SERIES II (DOZERS) S/N: 3YG5500-5733 Air Filter Primary..... A-5549M Air Filter Primary..... A-5549					

MODEL/APPLICATION	SAKURA NO
CATERPILLAR	
D6H SERIES II (DOZERS) S/N: 4LG935-3999	
Air Filter Secondary.....	A-5522
Air Filter Primary.....	A-5509
Air Filter Set.....	A-5522-S
Hydraulic Oil Filter.....	H-5510
Hydraulic Oil Filter.....	H-5503
D6H SERIES II (DOZERS) S/N: 4RC1050-2444	
Air Filter Set.....	A-5522-S
Air Filter Primary.....	A-5509
Air Filter Secondary.....	A-5522
Hydraulic Oil Filter.....	H-55280
Hydraulic Oil Filter.....	H-5526
Hydraulic Oil Filter.....	HC-55310
Hydraulic Oil Filter.....	H-5510
D6H SERIES II (DOZERS) S/N: 4RC1-1049	
Air Filter Secondary.....	A-5522
Air Filter Primary.....	A-5509
Air Filter Set.....	A-5522-S
Hydraulic Oil Filter.....	H-5510
Hydraulic Oil Filter.....	HC-55310
D6H SERIES II (DOZERS) S/N: 4RC2445-2550	
Air Filter Set.....	A-5522-S
Air Filter Primary.....	A-5509
Air Filter Secondary.....	A-5522
Hydraulic Oil Filter.....	H-5526
Hydraulic Oil Filter.....	H-55280
Hydraulic Oil Filter.....	HC-55310
Hydraulic Oil Filter.....	H-5510
D6H SERIES II (DOZERS) S/N: 4RC2551-4050	
Air Filter Secondary.....	A-5522
Air Filter Primary.....	A-5509
Air Filter Set.....	A-5522-S
Hydraulic Oil Filter.....	H-5510
Hydraulic Oil Filter.....	HC-55310
Hydraulic Oil Filter.....	H-55280
Hydraulic Oil Filter.....	H-5526
D6H SERIES II (DOZERS) S/N: 4RC4051-4217	
Air Filter Set.....	A-5522-S
Air Filter Primary.....	A-5509
Air Filter Secondary.....	A-5522
Hydraulic Oil Filter.....	HC-55310
Hydraulic Oil Filter.....	H-5503
Hydraulic Oil Filter.....	H-5510
Hydraulic Oil Filter.....	H-5526
Hydraulic Oil Filter.....	H-55280
D6H SERIES II (DOZERS) S/N: 4RC4218-4302	
Air Filter Secondary.....	A-5522
Air Filter Primary.....	A-5509
Air Filter Set.....	A-5522-S
Hydraulic Oil Filter.....	H-55280
Hydraulic Oil Filter.....	H-5526

MODEL/APPLICATION	SAKURA NO
CATERPILLAR	
Hydraulic Oil Filter.....	H-5510
Hydraulic Oil Filter.....	HC-55310
D6H SERIES II (DOZERS) S/N: 4RC4303-5499	
Air Filter Set.....	A-5522-S
Air Filter Primary.....	A-5509
Air Filter Secondary.....	A-5522
Hydraulic Oil Filter.....	HC-55310
Hydraulic Oil Filter.....	H-5503
Hydraulic Oil Filter.....	H-5510
Hydraulic Oil Filter.....	H-5526
Hydraulic Oil Filter.....	H-55280
D6H SERIES II (DOZERS) S/N: 4RC5500-UP	
Air Filter Set.....	A-5549M-S
Air Filter Primary.....	A-5549M
Air Filter Primary.....	A-5549
Air Filter Secondary.....	A-5550
Hydraulic Oil Filter.....	H-55280
Hydraulic Oil Filter.....	H-5526
Hydraulic Oil Filter.....	H-5510
Hydraulic Oil Filter.....	H-5503
Hydraulic Oil Filter.....	HC-55310
D6H SERIES II (DOZERS) S/N: 5HF1-4159	
Air Filter Secondary.....	A-5522
Air Filter Primary.....	A-5509
Air Filter Set.....	A-5522-S
Hydraulic Oil Filter.....	HC-55290
Hydraulic Oil Filter.....	H-5503
Hydraulic Oil Filter.....	H-5510
D6H SERIES II (DOZERS) S/N: 5HF4160-5513	
Air Filter Set.....	A-5522-S
Air Filter Primary.....	A-5509
Air Filter Secondary.....	A-5522
Hydraulic Oil Filter.....	H-5510
Hydraulic Oil Filter.....	H-5503
Hydraulic Oil Filter.....	HC-55290
D6H SERIES II (DOZERS) S/N: 5HF5514-UP	
Air Filter Set.....	A-5549M-S
Air Filter Primary.....	A-5549M
Air Filter Secondary.....	A-5550
Air Filter Primary.....	A-5549
Hydraulic Oil Filter.....	HC-55290
Hydraulic Oil Filter.....	H-5503
Hydraulic Oil Filter.....	H-5510
D6H SERIES II (DOZERS) S/N: 5KK1-UP	
Air Filter Primary.....	A-5549
Air Filter Secondary.....	A-5550
Air Filter Primary.....	A-5549M
Air Filter Set.....	A-5549M-S
Hydraulic Oil Filter.....	H-5510
Hydraulic Oil Filter.....	H-5503
Hydraulic Oil Filter.....	H-5526
Hydraulic Oil Filter.....	H-55280

MODEL/APPLICATION	SAKURA NO
CATERPILLAR	
D6H SERIES II (DOZERS) S/N: 6CF1-4159	
Air Filter Secondary.....	A-5522
Air Filter Primary.....	A-5509
Air Filter Set.....	A-5522-S
Hydraulic Oil Filter.....	H-5503
Hydraulic Oil Filter.....	HC-55290
Hydraulic Oil Filter.....	H-5510
D6H SERIES II (DOZERS) S/N: 6CF4160-5533	
Air Filter Set.....	A-5522-S
Air Filter Primary.....	A-5509
Air Filter Secondary.....	A-5522
Hydraulic Oil Filter.....	H-5510
Hydraulic Oil Filter.....	HC-55290
Hydraulic Oil Filter.....	H-5503
D6H SERIES II (DOZERS) S/N: 6CF5534-UP	
Air Filter Set.....	A-5549M-S
Air Filter Primary.....	A-5549M
Air Filter Secondary.....	A-5550
Air Filter Primary.....	A-5549
Hydraulic Oil Filter.....	H-5503
Hydraulic Oil Filter.....	HC-55290
Hydraulic Oil Filter.....	H-5510
D6H SERIES II (DOZERS) S/N: 6CK1-347	
Air Filter Primary.....	A-5549
Air Filter Secondary.....	A-5550
Air Filter Primary.....	A-5549M
Air Filter Set.....	A-5549M-S
Hydraulic Oil Filter.....	H-5510
Hydraulic Oil Filter.....	HC-55290
Hydraulic Oil Filter.....	H-5503
Hydraulic Oil Filter.....	H-55280
Hydraulic Oil Filter.....	H-5526
D6H SERIES II (DOZERS) S/N: 6CK348-UP	
Air Filter Set.....	A-5549M-S
Air Filter Primary.....	A-5549M
Air Filter Secondary.....	A-5550
Air Filter Primary.....	A-5549
Hydraulic Oil Filter.....	H-5526
Hydraulic Oil Filter.....	H-55280
Hydraulic Oil Filter.....	H-5503
Hydraulic Oil Filter.....	HC-55290
Hydraulic Oil Filter.....	H-5510
D6H SERIES II (DOZERS) S/N: 6FC1-355	
Air Filter Secondary.....	A-5522
Air Filter Primary.....	A-5509
Air Filter Set.....	A-5522-S
Hydraulic Oil Filter.....	H-5510
D6H SERIES II (DOZERS) S/N: 6FC356-691	
Air Filter Set.....	A-5522-S
Air Filter Primary.....	A-5509
Air Filter Secondary.....	A-5522

MODEL/APPLICATION	SAKURA NO	MODEL/APPLICATION	SAKURA NO	MODEL/APPLICATION	SAKURA NO
CATERPILLAR		CATERPILLAR		CATERPILLAR	
D6H SERIES II (DOZERS) S/N: 6FC356-691 Hydraulic Oil Filter..... H-55280 Hydraulic Oil Filter..... H-5526 Hydraulic Oil Filter..... H-5510 Hydraulic Oil Filter..... HC-55310		Air Filter Set..... A-5522-S Air Filter Secondary..... A-5522 Fuel Filter..... F-5505 Fuel Filter Secondary..... FC-5507 Hydraulic Oil Filter..... H-5503 Hydraulic Oil Filter..... H-5510 Hydraulic Oil Filter..... H-55280 Hydraulic Oil Filter..... H-5526 Oil Filter Full Flow..... C-5510		Air Filter Set..... A-5549M-S Hydraulic Oil Filter..... H-5526 Hydraulic Oil Filter..... H-55280 Hydraulic Oil Filter..... H-5510 Hydraulic Oil Filter..... HC-55290 Hydraulic Oil Filter..... H-5503	
D6H SERIES II (DOZERS) S/N: 6FC4034-4076 Air Filter Secondary..... A-5522 Air Filter Primary..... A-5509 Air Filter Set..... A-5522-S Hydraulic Oil Filter..... HC-55310 Hydraulic Oil Filter..... H-5503 Hydraulic Oil Filter..... H-5510 Hydraulic Oil Filter..... H-5526 Hydraulic Oil Filter..... H-55280		D6H SERIES II (DOZERS) S/N: 8KK1-311 Air Filter Secondary..... A-5522 Air Filter Set..... A-5522-S Air Filter Primary..... A-5509 Hydraulic Oil Filter..... H-5503 Hydraulic Oil Filter..... H-5510		D6H SERIES II (DOZERS) S/N: 9LK1-360 Air Filter Set..... A-5549M-S Air Filter Secondary..... A-5522 Air Filter Primary..... A-5509 Air Filter Set..... A-5522-S Air Filter Primary..... A-5549 Air Filter Secondary..... A-5550 Air Filter Primary..... A-5549M Hydraulic Oil Filter..... H-5503 Hydraulic Oil Filter..... HC-55290 Hydraulic Oil Filter..... H-5510	
D6H SERIES II (DOZERS) S/N: 6FC4077-4088 Air Filter Set..... A-5522-S Air Filter Primary..... A-5509 Air Filter Secondary..... A-5522 Hydraulic Oil Filter..... H-55280 Hydraulic Oil Filter..... H-5526 Hydraulic Oil Filter..... H-5510 Hydraulic Oil Filter..... HC-55310		D6H SERIES II (DOZERS) S/N: 8KK312-313 Air Filter Set..... A-5549M-S Air Filter Primary..... A-5549M Air Filter Secondary..... A-5550 Air Filter Primary..... A-5549 Hydraulic Oil Filter..... H-5510 Hydraulic Oil Filter..... H-5503		D6H SERIES II (DOZERS) S/N: 9LK361-UP Air Filter Primary..... A-5549M Air Filter Secondary..... A-5550 Air Filter Primary..... A-5549 Air Filter Set..... A-5549M-S Hydraulic Oil Filter..... H-5510 Hydraulic Oil Filter..... HC-55290 Hydraulic Oil Filter..... H-5503	
D6H SERIES II (DOZERS) S/N: 6FC4089-5499 Air Filter Secondary..... A-5522 Air Filter Primary..... A-5509 Air Filter Set..... A-5522-S Hydraulic Oil Filter..... HC-55310 Hydraulic Oil Filter..... H-5503 Hydraulic Oil Filter..... H-5510 Hydraulic Oil Filter..... H-5526 Hydraulic Oil Filter..... H-55280		D6H SERIES II (DOZERS) S/N: 8KK314-UP Air Filter Primary..... A-5549 Air Filter Secondary..... A-5550 Air Filter Primary..... A-5549M Air Filter Set..... A-5549M-S Hydraulic Oil Filter..... H-5503 Hydraulic Oil Filter..... H-5510		D6H SERIES II (DOZERS) S/N: 9RK1-UP Air Filter Secondary..... A-5522 Air Filter Set..... A-5522-S Air Filter Primary..... A-5509 Air Filter Primary..... A-5549 Fuel Filter Secondary..... FC-5507 Fuel Filter..... F-5505 Hydraulic Oil Filter..... H-5510 Hydraulic Oil Filter..... H-55280 Hydraulic Oil Filter..... H-5526 Hydraulic Oil Filter..... H-5503 Oil Filter Full Flow..... C-5510	
D6H SERIES II (DOZERS) S/N: 6FC5500-UP Air Filter Set..... A-5549M-S Air Filter Primary..... A-5549M Air Filter Primary..... A-5549 Air Filter Secondary..... A-5550 Hydraulic Oil Filter..... H-55280 Hydraulic Oil Filter..... H-5526 Hydraulic Oil Filter..... H-5510 Hydraulic Oil Filter..... H-5503 Hydraulic Oil Filter..... HC-55310		D6H SERIES II (DOZERS) S/N: 8ZJ1-UP Air Filter Primary..... A-5549M Air Filter Secondary..... A-5550 Air Filter Primary..... A-5549 Air Filter Set..... A-5549M-S Hydraulic Oil Filter..... H-5510 Hydraulic Oil Filter..... H-5503 Hydraulic Oil Filter..... H-5526 Hydraulic Oil Filter..... H-55280		D6H SERIES II (DOZERS) S/N: 9LK361-UP Air Filter Secondary..... A-5522 Air Filter Set..... A-5522-S Air Filter Primary..... A-5509 Air Filter Primary..... A-5549 Fuel Filter Secondary..... FC-5507 Fuel Filter..... F-5505 Hydraulic Oil Filter..... H-5510 Hydraulic Oil Filter..... H-55280 Hydraulic Oil Filter..... H-5526 Hydraulic Oil Filter..... H-5503 Oil Filter Full Flow..... C-5510	
D6H SERIES II (DOZERS) S/N: 6FC692-4033 Air Filter Secondary..... A-5522 Air Filter Set..... A-5522-S Air Filter Primary..... A-5509 Hydraulic Oil Filter..... HC-55310 Hydraulic Oil Filter..... H-5510 Hydraulic Oil Filter..... H-5526 Hydraulic Oil Filter..... H-55280		D6H SERIES II (DOZERS) S/N: 9KJ1-429 Air Filter Set..... A-5549M-S Air Filter Primary..... A-5549 Air Filter Secondary..... A-5550 Air Filter Primary..... A-5549M Hydraulic Oil Filter..... H-55280 Hydraulic Oil Filter..... H-5526 Hydraulic Oil Filter..... H-5503 Hydraulic Oil Filter..... HC-55290 Hydraulic Oil Filter..... H-5510		D6H SERIES II (DOZERS) S/N: 9RK1-UP Air Filter Secondary..... A-5549M Air Filter Primary..... A-5549 Air Filter Secondary..... A-5550 Air Filter Set..... A-5549M-S Fuel Filter Secondary..... FC-5507 Fuel Filter..... F-5505 Hydraulic Oil Filter..... H-5503 Hydraulic Oil Filter..... H-5510 Oil Filter Full Flow..... C-5510	
D6H SERIES II (DOZERS) S/N: 72K1-UP Air Filter Primary..... A-5509		D6H SERIES II (DOZERS) S/N: 9KJ430-UP Air Filter Primary..... A-5549M Air Filter Secondary..... A-5550 Air Filter Primary..... A-5549		D6H XL (DOZERS) S/N: 1YL,5KK,6CK,8KK,8ZJ,9KJ,9LK-UP Air Filter Secondary..... A-5522 Air Filter Primary..... A-5549M Air Filter Primary..... A-5549 Air Filter Secondary..... A-5550 Air Filter Set..... A-5549M-S Fuel Filter Secondary..... FC-5507 Fuel Filter..... F-5505 Hydraulic Oil Filter..... H-5503 Hydraulic Oil Filter..... H-5510 Oil Filter Full Flow..... C-5510	
		D6H XL (DOZERS) S/N: 8KK1-UP Air Filter Secondary..... A-5522 Air Filter Set..... A-5522-S Air Filter Primary..... A-5509 Fuel Filter Secondary..... FC-5507 Hydraulic Oil Filter..... H-5510 Hydraulic Oil Filter..... H-5503			

Sakura Filter

ENGINE APPLICATION

MODEL/APPLICATION	SAKURA NO
CATERPILLAR	
D6H XL (DOZERS) S/N: 8KK1-UP	
Oil Filter Full Flow.....	C-5510
D6H XL (DOZERS) S/N: 8ZJ1-UP	
Air Filter Set.....	A-5549M-S
Air Filter Secondary.....	A-5550
Air Filter Primary.....	A-5549
Air Filter Primary.....	A-5549M
Fuel Filter Secondary.....	FC-5507
Fuel Filter.....	F-5505
Hydraulic Oil Filter.....	H-5503
Hydraulic Oil Filter.....	H-5510
Oil Filter Full Flow.....	C-5510
D6H XL (DOZERS) S/N: 9KJ1-UP	
Air Filter Primary.....	A-5549M
Air Filter Primary.....	A-5549
Air Filter Secondary.....	A-5550
Air Filter Set.....	A-5549M-S
Fuel Filter Secondary.....	FC-5507
Fuel Filter.....	F-5505
Hydraulic Oil Filter.....	H-55280
Hydraulic Oil Filter.....	H-5526
Hydraulic Oil Filter.....	H-5510
Hydraulic Oil Filter.....	H-5503
Oil Filter Full Flow.....	C-5510
D6H XL (DOZERS) S/N: 9LK1-UP	
Air Filter Primary.....	A-5509
Air Filter Set.....	A-5522-S
Air Filter Secondary.....	A-5522
Fuel Filter Secondary.....	FC-5507
Hydraulic Oil Filter.....	H-5503
Hydraulic Oil Filter.....	H-5510
Oil Filter Full Flow.....	C-5510
D6H XL SERIES II (DOZERS) CAT 3306	
Cabin Air Filter.....	CA-55140
D6H XL SERIES II (DOZERS) S/N: 8KK1-UP	
Air Filter Primary.....	A-5509
Air Filter Set.....	A-5522-S
Air Filter Secondary.....	A-5522
Air Filter Secondary.....	A-5522
Air Filter Set.....	A-5549M-S
Air Filter Secondary.....	A-5550
Air Filter Primary.....	A-5549
Air Filter Primary.....	A-5549M
Fuel Filter.....	F-5505
Fuel Filter Secondary.....	FC-5507
Hydraulic Oil Filter.....	H-5526
Hydraulic Oil Filter.....	H-5503
Hydraulic Oil Filter.....	H-55280
Hydraulic Oil Filter.....	H-5510
Oil Filter Full Flow.....	C-5510
D6H XL SERIES II (DOZERS) S/N: 8ZJ1-UP	
Air Filter Primary.....	A-5549M

MODEL/APPLICATION	SAKURA NO
CATERPILLAR	
Air Filter Primary.....	A-5549
Air Filter Secondary.....	A-5550
Air Filter Set.....	A-5549M-S
Fuel Filter Secondary.....	FC-5507
Fuel Filter.....	F-5505
Hydraulic Oil Filter.....	H-5510
Hydraulic Oil Filter.....	H-55280
Hydraulic Oil Filter.....	H-5503
Hydraulic Oil Filter.....	H-5526
Oil Filter Full Flow.....	C-5510
D6H XL SERIES II (DOZERS) S/N: 9LK1-UP	
Air Filter Set.....	A-5549M-S
Air Filter Secondary.....	A-5550
Air Filter Primary.....	A-5549
Air Filter Primary.....	A-5549M
Fuel Filter.....	F-5505
Fuel Filter Secondary.....	FC-5507
Hydraulic Oil Filter.....	H-5526
Hydraulic Oil Filter.....	H-5503
Hydraulic Oil Filter.....	H-55280
Hydraulic Oil Filter.....	H-5510
Oil Filter Full Flow.....	C-5510
D6H XR (DOZERS) S/N: 1YL1-UP	
Air Filter Secondary.....	A-5522
Air Filter Primary.....	A-5509
Air Filter Set.....	A-5522-S
Fuel Filter Secondary.....	FC-5507
Hydraulic Oil Filter.....	H-5503
Oil Filter Full Flow.....	C-5510
D6H XR (DOZERS) S/N: 2BL1-UP	
Air Filter Secondary.....	A-5522
Air Filter Set.....	A-5522-S
Air Filter Primary.....	A-5509
Fuel Filter Secondary.....	FC-5507
Hydraulic Oil Filter.....	H-5503
Oil Filter Full Flow.....	C-5510
D6H XR (DOZERS) S/N: 5KK1-UP	
Air Filter Primary.....	A-5549M
Air Filter Primary.....	A-5549
Air Filter Secondary.....	A-5550
Air Filter Set.....	A-5549M-S
Fuel Filter Secondary.....	FC-5507
Hydraulic Oil Filter.....	H-5503
Hydraulic Oil Filter.....	H-5510
Oil Filter Full Flow.....	C-5510
D6H XR (DOZERS) S/N: 6CK1-UP	
Air Filter Primary.....	A-5549
Air Filter Primary.....	A-5549M
Air Filter Set.....	A-5549M-S
Fuel Filter Secondary.....	FC-5507
Hydraulic Oil Filter.....	H-5503
Hydraulic Oil Filter.....	H-5510
Oil Filter Full Flow.....	C-5510
D6H XR (DOZERS) S/N: 6CK1-UP	
Air Filter Primary.....	A-5549
Air Filter Primary.....	A-5549M
Air Filter Set.....	A-5549M-S
Air Filter Secondary.....	A-5550
Fuel Filter Secondary.....	FC-5507
Hydraulic Oil Filter.....	H-5510
Hydraulic Oil Filter.....	H-5503
Oil Filter Full Flow.....	C-5510

MODEL/APPLICATION	SAKURA NO
CATERPILLAR	
D6H XR SERIES II (DOZERS) CAT 3306	
Cabin Air Filter.....	CA-55140
D6H XR SERIES II (DOZERS) S/N: 1YL1-UP	
Air Filter Primary.....	A-5549
Air Filter Primary.....	A-5549M
Air Filter Set.....	A-5549M-S
Air Filter Secondary.....	A-5550
Fuel Filter Secondary.....	FC-5507
Fuel Filter.....	F-5505
Hydraulic Oil Filter.....	H-5510
Hydraulic Oil Filter.....	H-55280
Hydraulic Oil Filter.....	H-5526
Hydraulic Oil Filter.....	H-5503
Oil Filter Full Flow.....	C-5510
D6H XR SERIES II (DOZERS) S/N: 2BL1-UP	
Air Filter Primary.....	A-5509
Air Filter Set.....	A-5522-S
Air Filter Secondary.....	A-5522
Fuel Filter.....	F-5505
Fuel Filter Secondary.....	FC-5507
Hydraulic Oil Filter.....	H-5503
Hydraulic Oil Filter.....	H-5526
Hydraulic Oil Filter.....	H-55280
Hydraulic Oil Filter.....	H-5510
Oil Filter Full Flow.....	C-5510
D6H XR SERIES II (DOZERS) S/N: 5KK1-UP	
Air Filter Secondary.....	A-5550
Air Filter Set.....	A-5549M-S
Air Filter Primary.....	A-5549M
Air Filter Primary.....	A-5549
Fuel Filter Secondary.....	FC-5507
Fuel Filter.....	F-5505
Hydraulic Oil Filter.....	H-5510
Hydraulic Oil Filter.....	H-55280
Hydraulic Oil Filter.....	H-5526
Hydraulic Oil Filter.....	H-5503
Oil Filter Full Flow.....	C-5510
D6H XR SERIES II (DOZERS) S/N: 6CK1-UP	
Air Filter Primary.....	A-5549
Air Filter Primary.....	A-5549M
Air Filter Set.....	A-5549M-S
Air Filter Secondary.....	A-5550
Fuel Filter.....	F-5505
Fuel Filter Secondary.....	FC-5507
Hydraulic Oil Filter.....	H-5503
Hydraulic Oil Filter.....	H-5526
Hydraulic Oil Filter.....	H-55280
Hydraulic Oil Filter.....	H-5510
Oil Filter Full Flow.....	C-5510
D6K (DOZERS) CAT S/N: C6E1-UP , 2007-UP	
Fuel Filter Secondary.....	FC-5515
Fuel Filter.....	FC-5516

Sakura Filter

ENGINE APPLICATION

MODEL/APPLICATION	SAKURA NO	MODEL/APPLICATION	SAKURA NO	MODEL/APPLICATION	SAKURA NO
CATERPILLAR		CATERPILLAR		CATERPILLAR	
D6K (DOZERS) CAT S/N: C6E1-UP , 2007-UP Fuel Filter Secondary..... FC-55151 Hydraulic Oil Filter..... HC-5504		D6M LGP (DOZERS) S/N: 4HS1-UP Air Filter Set..... A-5549M-S Air Filter Secondary..... A-5550 Air Filter Primary..... A-5549 Air Filter Primary..... A-5549M Fuel Filter Secondary..... FC-55151 Fuel Filter Secondary..... FC-5515 Fuel Filter..... FC-5516 Hydraulic Oil Filter..... H-5510 Hydraulic Oil Filter..... HC-5507 Hydraulic Oil Filter..... HC-55220 Oil Filter Full Flow..... C-5510		D6M XL (DOZERS) S/N: 4HS1-UP Air Filter Primary..... A-5549M Air Filter Primary..... A-5549 Air Filter Secondary..... A-5550 Air Filter Set..... A-5549M-S Fuel Filter Secondary..... FC-5515 Fuel Filter Secondary..... FC-55151 Fuel Filter..... FC-5516 Hydraulic Oil Filter..... HC-5507 Hydraulic Oil Filter..... H-5510 Hydraulic Oil Filter..... HC-55220 Oil Filter Full Flow..... C-5510	
D6K (DOZERS) CAT S/N: FBH1-UP , 2007-UP Fuel Filter Secondary..... FC-55151 Fuel Filter..... FC-5516 Fuel Filter Secondary..... FC-5515 Hydraulic Oil Filter..... HC-5504		D6M LGP (DOZERS) S/N: 5NR1-UP Air Filter Primary..... A-5549M Air Filter Primary..... A-5549 Air Filter Secondary..... A-5550 Air Filter Set..... A-5549M-S Fuel Filter Secondary..... FC-5515 Fuel Filter Secondary..... FC-55151 Fuel Filter..... FC-5516 Hydraulic Oil Filter..... HC-55220 Hydraulic Oil Filter..... HC-5507 Hydraulic Oil Filter..... H-5510 Hydraulic Oil Filter..... H-5526 Oil Filter Full Flow..... C-5510		D6M XL (DOZERS) S/N: 5NR1-UP Air Filter Set..... A-5549M-S Air Filter Secondary..... A-5550 Air Filter Primary..... A-5549 Air Filter Primary..... A-5549M Fuel Filter..... FC-5516 Fuel Filter Secondary..... FC-55151 Fuel Filter Secondary..... FC-5515 Hydraulic Oil Filter..... HC-55220 Hydraulic Oil Filter..... H-5510 Hydraulic Oil Filter..... HC-5507 Oil Filter Full Flow..... C-5510	
D6K LGP (DOZERS) w/C6.6 Eng. Fuel/Water Separator..... SFC-55170		D6M LGP (DOZERS) S/N: 9ZM1-UP Air Filter Set..... A-5549M-S Air Filter Secondary..... A-5550 Air Filter Primary..... A-5549 Air Filter Primary..... A-5549M Fuel Filter..... FC-5516 Fuel Filter Secondary..... FC-55151 Fuel Filter Secondary..... FC-5515 Fuel Filter..... FC-5508 Hydraulic Oil Filter..... H-5526 Hydraulic Oil Filter..... H-5510 Oil Filter Full Flow..... C-5510		D6N (DOZERS) CAT (S/N: BMA1-UP) Fuel Filter..... FC-5517 Oil Filter Full Flow..... C-5522	
D6K XL (DOZERS) w/C6.6 Eng. Fuel/Water Separator..... SFC-55170		D6M XL (DOZERS) S/N: 2YS1-UP Air Filter Primary..... A-5549M Air Filter Primary..... A-5549 Air Filter Secondary..... A-5550 Air Filter Set..... A-5549M-S Fuel Filter Secondary..... FC-5515 Fuel Filter Secondary..... FC-55151 Fuel Filter..... FC-5516 Hydraulic Oil Filter..... HC-55220 Hydraulic Oil Filter..... HC-5507 Hydraulic Oil Filter..... H-5510 Oil Filter Full Flow..... C-5510		D6N (DOZERS) CAT (S/N: C6E1-UP) Fuel Filter Secondary..... FC-55151 Fuel Filter Secondary..... FC-5515 Fuel Filter..... FC-5516	
D6M (DOZERS) S/N: 5WF1-UP Air Filter Primary..... A-5549M Air Filter Primary..... A-5549 Air Filter Secondary..... A-5550 Air Filter Set..... A-5549M-S Fuel Filter Secondary..... FC-5515 Fuel Filter Secondary..... FC-55151 Fuel Filter..... FC-5516 Hydraulic Oil Filter..... H-5510 Oil Filter Full Flow..... C-5510		D6M XL (DOZERS) CAT 3116 Cabin Air Filter..... CA-55140		D6N (DOZERS) S/N: AKM1-675-UP Air Filter Primary..... A-5549M Air Filter..... A-5547 Air Filter Primary..... A-5549 Air Filter Set..... A-5549M-S Air Filter Secondary..... A-5550 Hydraulic Oil Filter..... HC-5504 Hydraulic Oil Filter..... H-55280 Hydraulic Oil Filter..... H-5526 Hydraulic Oil Filter..... H-5510	
D6M LGP (DOZERS) CAT 3116 Cabin Air Filter..... CA-55140		D6M XL (DOZERS) S/N: 4GS1-UP Air Filter Primary..... A-5549M Air Filter Primary..... A-5549 Air Filter Secondary..... A-5550 Air Filter Set..... A-5549M-S Fuel Filter Secondary..... FC-5515 Fuel Filter Secondary..... FC-55151 Fuel Filter..... FC-5516 Hydraulic Oil Filter..... HC-55220 Hydraulic Oil Filter..... HC-5507 Hydraulic Oil Filter..... H-5510 Oil Filter Full Flow..... C-5510			
D6M LGP (DOZERS) S/N: 2YS1-UP Air Filter Set..... A-5549M-S Air Filter Secondary..... A-5550 Air Filter Primary..... A-5549 Air Filter Primary..... A-5549M Fuel Filter..... FC-5516 Fuel Filter Secondary..... FC-55151 Fuel Filter Secondary..... FC-5515 Hydraulic Oil Filter..... H-5510 Hydraulic Oil Filter..... HC-5507 Hydraulic Oil Filter..... HC-55220 Oil Filter Full Flow..... C-5510		D6M XL (DOZERS) S/N: 4GS1-UP Air Filter Primary..... A-5549M Air Filter Primary..... A-5549 Air Filter Secondary..... A-5550 Air Filter Set..... A-5549M-S Fuel Filter Secondary..... FC-5515 Fuel Filter Secondary..... FC-55151 Fuel Filter..... FC-5516 Hydraulic Oil Filter..... HC-5507 Hydraulic Oil Filter..... H-5510 Hydraulic Oil Filter..... HC-55220 Oil Filter Full Flow..... C-5510			

MODEL/APPLICATION	SAKURA NO	MODEL/APPLICATION	SAKURA NO	MODEL/APPLICATION	SAKURA NO
CATERPILLAR		CATERPILLAR		CATERPILLAR	
D6N (DOZERS) S/N: AKM1794-1821-UP Air Filter Secondary..... A-5550 Air Filter Set..... A-5549M-S Air Filter Primary..... A-5549 Air Filter..... A-5547 Air Filter Primary..... A-5549M Hydraulic Oil Filter..... H-5510 Hydraulic Oil Filter..... HC-5504		Hydraulic Oil Filter..... H-5526 Hydraulic Oil Filter..... H-55280 Hydraulic Oil Filter..... H-5510 D6N (DOZERS) S/N: ALH347-UP Air Filter Secondary..... A-5550 Air Filter Set..... A-5549M-S Air Filter Primary..... A-5549 Air Filter..... A-5547 Air Filter Primary..... A-5549M Hydraulic Oil Filter..... H-5510		Air Filter Secondary..... A-5550 Hydraulic Oil Filter..... HC-5504 Hydraulic Oil Filter..... H-5526 Hydraulic Oil Filter..... H-55280 Hydraulic Oil Filter..... H-5510	
D6N (DOZERS) S/N: AKM1822-UP Air Filter Primary..... A-5549M Air Filter..... A-5547 Air Filter Primary..... A-5549 Air Filter Set..... A-5549M-S Air Filter Secondary..... A-5550 Hydraulic Oil Filter..... HC-5504 Hydraulic Oil Filter..... H-5510		D6N (DOZERS) S/N: ALR1-219-UP Air Filter Primary..... A-5549M Air Filter..... A-5547 Air Filter Primary..... A-5549 Air Filter Set..... A-5549M-S Air Filter Secondary..... A-5550 Hydraulic Oil Filter..... HC-5507 Hydraulic Oil Filter..... H-55280 Hydraulic Oil Filter..... H-5526 Hydraulic Oil Filter..... HC-55220 Hydraulic Oil Filter..... H-5510		D6N (DOZERS) S/N: ALY2066-2102-UP Air Filter Secondary..... A-5550 Air Filter Set..... A-5549M-S Air Filter Primary..... A-5549 Air Filter..... A-5547 Air Filter Primary..... A-5549M Hydraulic Oil Filter..... H-5510 Hydraulic Oil Filter..... HC-5504	
D6N (DOZERS) S/N: AKM676-1793-UP Air Filter Secondary..... A-5550 Air Filter Set..... A-5549M-S Air Filter Primary..... A-5549 Air Filter..... A-5547 Air Filter Primary..... A-5549M Hydraulic Oil Filter..... H-5510 Hydraulic Oil Filter..... HC-5504		D6N (DOZERS) S/N: ALR220-251-UP Air Filter Secondary..... A-5550 Air Filter Set..... A-5549M-S Air Filter Primary..... A-5549 Air Filter..... A-5547 Air Filter Primary..... A-5549M Hydraulic Oil Filter..... H-5510 Hydraulic Oil Filter..... HC-55220 Hydraulic Oil Filter..... H-5526 Hydraulic Oil Filter..... H-55280 Hydraulic Oil Filter..... HC-5507		D6N (DOZERS) S/N: ALY2103-UP Air Filter Primary..... A-5549M Air Filter..... A-5547 Air Filter Primary..... A-5549 Air Filter Set..... A-5549M-S Air Filter Secondary..... A-5550 Hydraulic Oil Filter..... HC-5504 Hydraulic Oil Filter..... H-5510	
D6N (DOZERS) S/N: ALH1-197-UP Air Filter Primary..... A-5549M Air Filter..... A-5547 Air Filter Primary..... A-5549 Air Filter Set..... A-5549M-S Air Filter Secondary..... A-5550 Hydraulic Oil Filter..... H-5526 Hydraulic Oil Filter..... HC-55220 Hydraulic Oil Filter..... H-55280 Hydraulic Oil Filter..... HC-5507 Hydraulic Oil Filter..... H-5510		D6N (DOZERS) S/N: ALR252-323-UP Air Filter Primary..... A-5549M Air Filter..... A-5547 Air Filter Primary..... A-5549 Air Filter Set..... A-5549M-S Air Filter Secondary..... A-5550 Hydraulic Oil Filter..... H-55280 Hydraulic Oil Filter..... H-5526 Hydraulic Oil Filter..... H-5510		D6N (DOZERS) S/N: ALY706-2065-UP Air Filter Secondary..... A-5550 Air Filter Set..... A-5549M-S Air Filter Primary..... A-5549 Air Filter..... A-5547 Air Filter Primary..... A-5549M Hydraulic Oil Filter..... H-5510 Hydraulic Oil Filter..... HC-5504	
D6N (DOZERS) S/N: ALH198-253-UP Air Filter Secondary..... A-5550 Air Filter Set..... A-5549M-S Air Filter Primary..... A-5549 Air Filter..... A-5547 Air Filter Primary..... A-5549M Hydraulic Oil Filter..... H-5510 Hydraulic Oil Filter..... HC-5507 Hydraulic Oil Filter..... H-55280 Hydraulic Oil Filter..... HC-5507 Hydraulic Oil Filter..... H-5510		D6N (DOZERS) S/N: ALR324-UP Air Filter Secondary..... A-5550 Air Filter Set..... A-5549M-S Air Filter Primary..... A-5549 Air Filter..... A-5547 Air Filter Primary..... A-5549M Hydraulic Oil Filter..... H-5510		D6N (DOZERS) S/N: CBJ1-259-UP Air Filter Primary..... A-5549M Air Filter..... A-5547 Air Filter Primary..... A-5549 Air Filter Set..... A-5549M-S Air Filter Secondary..... A-5550 Hydraulic Oil Filter..... H-55280 Hydraulic Oil Filter..... H-5526 Hydraulic Oil Filter..... HC-55220 Hydraulic Oil Filter..... HC-5507 Hydraulic Oil Filter..... H-5510	
D6N (DOZERS) S/N: ALH254-346-UP Air Filter Set..... A-5549M-S Air Filter Secondary..... A-5550 Air Filter Primary..... A-5549M Air Filter..... A-5547 Air Filter Primary..... A-5549		Air Filter Primary..... A-5549M Air Filter..... A-5547 Air Filter Primary..... A-5549 Hydraulic Oil Filter..... H-5510		D6N (DOZERS) S/N: CBJ260-399-UP Air Filter Secondary..... A-5550 Air Filter Set..... A-5549M-S Air Filter Primary..... A-5549 Air Filter..... A-5547 Air Filter Primary..... A-5549M Hydraulic Oil Filter..... H-5510 Hydraulic Oil Filter..... HC-55220	
		D6N (DOZERS) S/N: ALY1-705-UP Air Filter Primary..... A-5549M Air Filter..... A-5547 Air Filter Primary..... A-5549 Air Filter Set..... A-5549M-S		D6N (DOZERS) S/N: CBJ400-504-UP Air Filter Primary..... A-5549M Air Filter..... A-5547 Air Filter Primary..... A-5549	

MODEL/APPLICATION	SAKURA NO	MODEL/APPLICATION	SAKURA NO	MODEL/APPLICATION	SAKURA NO
CATERPILLAR		CATERPILLAR		CATERPILLAR	
D6N (DOZERS) S/N: CBJ400-504-UP Air Filter Set..... A-5549M-S Air Filter Secondary..... A-5550 Hydraulic Oil Filter..... HC-5507 Hydraulic Oil Filter..... HC-55220 Hydraulic Oil Filter..... H-5510		Air Filter..... A-5547 Air Filter Primary..... A-5549 Air Filter Set..... A-5549M-S Air Filter Secondary..... A-5550 Hydraulic Oil Filter..... HC-5504 Hydraulic Oil Filter..... H-5510		D6R (DOZERS) CAT C9 (S/N: 2HM1-UP) Air Filter Primary..... A-5549M Air Filter Secondary..... A-5550 Air Filter Primary..... A-5549 Air Filter Set..... A-5549M-S Fuel Filter..... F-5505 Fuel Filter..... FC-5519 Fuel Filter Secondary..... FC-5507 Hydraulic Oil Filter..... H-5526 Hydraulic Oil Filter..... H-5510 Oil Filter Full Flow..... C-5510	
D6N (DOZERS) S/N: CBJ505-UP Air Filter Primary..... A-5549 Air Filter..... A-5547 Air Filter Primary..... A-5549M Air Filter Secondary..... A-5550 Air Filter Set..... A-5549M-S Hydraulic Oil Filter..... HC-55220 Hydraulic Oil Filter..... H-5510 Hydraulic Oil Filter..... HC-5507		D6N (DOZERS) S/N: DJA1-UP Air Filter..... A-5547 Hydraulic Oil Filter..... H-5510 Hydraulic Oil Filter..... HC-5504		D6R (DOZERS) CAT C9 (S/N: 2YN1-UP) Air Filter Set..... A-5549M-S Air Filter Primary..... A-5549 Air Filter Secondary..... A-5550 Air Filter Primary..... A-5549M Fuel Filter Secondary..... FC-5507 Fuel Filter..... FC-5519 Fuel Filter..... F-5505 Hydraulic Oil Filter..... H-5526 Hydraulic Oil Filter..... H-5510 Oil Filter Full Flow..... C-5510	
D6N (DOZERS) S/N: CCK1-366-UP Air Filter Primary..... A-5549M Air Filter..... A-5547 Air Filter Primary..... A-5549 Air Filter Set..... A-5549M-S Air Filter Secondary..... A-5550 Hydraulic Oil Filter..... HC-5504 Hydraulic Oil Filter..... H-5526 Hydraulic Oil Filter..... H-55280 Hydraulic Oil Filter..... H-5510		D6N (DOZERS) w/3126B Eng. Hydraulic Oil Filter..... HC-55280		D6R (DOZERS) CAT C9 (S/N: 32N1-UP) Air Filter Primary..... A-5549M Air Filter Secondary..... A-5550 Air Filter Primary..... A-5549 Air Filter Set..... A-5549M-S Fuel Filter..... F-5505 Fuel Filter..... FC-5519 Fuel Filter Secondary..... FC-5507 Hydraulic Oil Filter..... H-5526 Hydraulic Oil Filter..... H-5510 Oil Filter Full Flow..... C-5510	
D6N (DOZERS) S/N: CCK367-691-UP Air Filter Secondary..... A-5550 Air Filter Set..... A-5549M-S Air Filter Primary..... A-5549 Air Filter..... A-5547 Air Filter Primary..... A-5549M Hydraulic Oil Filter..... H-5510 Hydraulic Oil Filter..... HC-5504		D6N (DOZERS) w/C9 Eng. Hydraulic Oil Filter..... HC-55280		D6R (DOZERS) CAT C9 (S/N: 4FM/8TM/9BM-UP) Air Filter Set..... A-5549M-S Air Filter Primary..... A-5549 Air Filter Secondary..... A-5550 Air Filter Primary..... A-5549M Fuel Filter Secondary..... FC-5507 Fuel Filter..... F-5505 Hydraulic Oil Filter..... H-5526 Hydraulic Oil Filter..... H-5510 Oil Filter Full Flow..... C-5510	
D6N (DOZERS) S/N: CCK692-701-UP Air Filter Primary..... A-5549M Air Filter..... A-5547 Air Filter Primary..... A-5549 Air Filter Set..... A-5549M-S Air Filter Secondary..... A-5550 Hydraulic Oil Filter..... HC-5504 Hydraulic Oil Filter..... H-5510		D6N (DOZERS) w/3126B Eng. Hydraulic Oil Filter..... HC-55280		D6R (DOZERS) CAT C9 (S/N: 4FM1-UP) Air Filter Primary..... A-5549M Air Filter Secondary..... A-5550 Air Filter Primary..... A-5549 Air Filter Set..... A-5549M-S Fuel Filter..... F-5505 Fuel Filter..... FC-5519 Fuel Filter Secondary..... FC-5507 Hydraulic Oil Filter..... H-5526 Hydraulic Oil Filter..... H-5510 Oil Filter Full Flow..... C-5510	
D6N (DOZERS) S/N: CCK709-UP Air Filter Secondary..... A-5550 Air Filter Set..... A-5549M-S Air Filter Primary..... A-5549 Air Filter..... A-5547 Air Filter Primary..... A-5549M Hydraulic Oil Filter..... H-5510 Hydraulic Oil Filter..... HC-5504		D6N (DOZERS) w/C6.6 ENG. (EXC. S/N: PBA, PER) Fuel/Water Separator..... SFC-55170		D6R (DOZERS) CAT C9 (S/N: 1RW1-UP) Air Filter Set..... A-5549M-S Air Filter Primary..... A-5549 Air Filter Secondary..... A-5550 Air Filter Primary..... A-5549M Fuel Filter Secondary..... FC-5507 Fuel Filter..... FC-5519 Fuel Filter..... F-5505 Hydraulic Oil Filter..... H-5526 Hydraulic Oil Filter..... H-5510 Oil Filter Full Flow..... C-5510	
D6N (DOZERS) S/N: CCK702-708-UP Air Filter Primary..... A-5549M		D6N (DOZERS) w/C6.6 ENG. (EXC. S/N: PBA, PER) Fuel/Water Separator..... SFC-55170		D6R (DOZERS) CAT 3306 Cabin Air Filter..... CA-55140	

MODEL/APPLICATION	SAKURA NO	MODEL/APPLICATION	SAKURA NO	MODEL/APPLICATION	SAKURA NO
CATERPILLAR		CATERPILLAR		CATERPILLAR	
D6R (DOZERS) S/N: 9BM1-UP		Air Filter Primary..... A-5549M		Air Filter Secondary..... A-5550	
Hydraulic Oil Filter..... H-55280		Hydraulic Oil Filter..... H-55280		Hydraulic Oil Filter..... H-55280	
Hydraulic Oil Filter..... H-5526		Hydraulic Oil Filter..... HC-55290		Hydraulic Oil Filter..... H-5526	
Hydraulic Oil Filter..... H-5510		Hydraulic Oil Filter..... H-5510		Hydraulic Oil Filter..... HC-55290	
Hydraulic Oil Filter..... HC-55290		Hydraulic Oil Filter..... H-5510		Hydraulic Oil Filter..... H-5510	
D6R (DOZERS) S/N: 9MN1-UP		D6R II (DOZERS) S/N: ACJ1-UP		D6R II (DOZERS) S/N: BLE1-UP	
Air Filter Primary..... A-5549M		Air Filter Primary..... A-5549M		Air Filter Primary..... A-5549M	
Air Filter Set..... A-5549M-S		Air Filter Primary..... A-5549		Air Filter Primary..... A-5549	
Air Filter Primary..... A-5549		Air Filter Secondary..... A-5550		Air Filter Secondary..... A-5550	
Air Filter Secondary..... A-5550		Air Filter Set..... A-5549M-S		Air Filter Secondary..... A-5550	
Hydraulic Oil Filter..... H-5526		Hydraulic Oil Filter..... H-5510		Air Filter Set..... A-5549M-S	
Hydraulic Oil Filter..... H-55280		Hydraulic Oil Filter..... HC-55290		Hydraulic Oil Filter..... HC-55290	
Hydraulic Oil Filter..... H-5510		Hydraulic Oil Filter..... H-5526		Hydraulic Oil Filter..... H-5526	
Hydraulic Oil Filter..... HC-55290		Hydraulic Oil Filter..... H-55280		Hydraulic Oil Filter..... H-5526	
D6R (DOZERS) S/N: 9PN1-UP		D6R II (DOZERS) S/N: ADE1-UP		D6R II (DOZERS) S/N: BLT1-UP	
Air Filter Secondary..... A-5550		Air Filter Set..... A-5549M-S		Air Filter Primary..... A-5549M	
Air Filter Primary..... A-5549		Air Filter Secondary..... A-5550		Air Filter Set..... A-5549M-S	
Air Filter Set..... A-5549M-S		Air Filter Primary..... A-5549		Air Filter Secondary..... A-5550	
Air Filter Primary..... A-5549M		Air Filter Primary..... A-5549M		Air Filter Primary..... A-5549	
Hydraulic Oil Filter..... HC-55290		Hydraulic Oil Filter..... H-55280		Hydraulic Oil Filter..... H-55280	
Hydraulic Oil Filter..... H-5510		Hydraulic Oil Filter..... H-5526		Hydraulic Oil Filter..... H-5526	
Hydraulic Oil Filter..... H-55280		Hydraulic Oil Filter..... HC-55290		Hydraulic Oil Filter..... H-5526	
Hydraulic Oil Filter..... H-5526		Hydraulic Oil Filter..... H-5510		Hydraulic Oil Filter..... HC-55290	
D6R (DOZERS) S/N: 9ZS1-UP		D6R II (DOZERS) S/N: AEM1-UP		D6R II (DOZERS) S/N: BMJ1-UP	
Air Filter Primary..... A-5549M		Air Filter Primary..... A-5549M		Air Filter Primary..... A-5549M	
Air Filter Set..... A-5549M-S		Air Filter Primary..... A-5549		Air Filter Primary..... A-5549	
Air Filter Primary..... A-5549		Air Filter Secondary..... A-5550		Air Filter Secondary..... A-5550	
Air Filter Secondary..... A-5550		Air Filter Set..... A-5549M-S		Air Filter Set..... A-5549M-S	
Hydraulic Oil Filter..... H-5526		Hydraulic Oil Filter..... H-5510		Hydraulic Oil Filter..... HC-55290	
Hydraulic Oil Filter..... H-55280		Hydraulic Oil Filter..... HC-55290		Hydraulic Oil Filter..... H-5526	
Hydraulic Oil Filter..... H-5510		Hydraulic Oil Filter..... H-5526		Hydraulic Oil Filter..... H-5526	
Hydraulic Oil Filter..... HC-55290		Hydraulic Oil Filter..... H-5510		Hydraulic Oil Filter..... H-55280	
D6R (DOZERS) S/N: DMP1-UP		D6R II (DOZERS) S/N: AEP1-UP		D6R II (DOZERS) S/N: BMY1-UP	
Air Filter Set..... A-5549M-S		Air Filter Primary..... A-5549M		Air Filter Set..... A-5549M-S	
Air Filter Set..... A-5565-S		Air Filter Primary..... A-5549		Air Filter Secondary..... A-5550	
Air Filter Secondary..... A-5563		Air Filter Set..... A-5549M-S		Air Filter Primary..... A-5549	
Air Filter Primary..... A-5564		Air Filter Secondary..... A-5550		Air Filter Primary..... A-5549M	
Air Filter Secondary..... A-5550		Air Filter Primary..... A-5549		Hydraulic Oil Filter..... H-55280	
Air Filter Primary..... A-5549		Hydraulic Oil Filter..... H-5510		Hydraulic Oil Filter..... H-5526	
Air Filter Primary..... A-5549M		Hydraulic Oil Filter..... H-55280		Hydraulic Oil Filter..... HC-55290	
Hydraulic Oil Filter..... HC-55290		Hydraulic Oil Filter..... H-5526		Hydraulic Oil Filter..... HC-55290	
Hydraulic Oil Filter..... H-5510		Hydraulic Oil Filter..... HC-55290		Hydraulic Oil Filter..... HC-55290	
Hydraulic Oil Filter..... H-55280		Hydraulic Oil Filter..... H-5526		Hydraulic Oil Filter..... HC-55290	
Hydraulic Oil Filter..... H-5526		Hydraulic Oil Filter..... HC-55290		Hydraulic Oil Filter..... HC-55290	
D6R II (DOZERS) CAT C9		D6R II (DOZERS) S/N: AFM1-UP		D6R II (DOZERS) S/N: BNC1-UP	
Cabin Air Filter..... CA-55140		Air Filter Primary..... A-5549M		Air Filter Primary..... A-5549M	
D6R II (DOZERS) CAT (S/N: 4ZF1-UP)		Air Filter Primary..... A-5549		Air Filter Secondary..... A-5550	
Fuel Filter..... FC-5517		Air Filter Secondary..... A-5550		Air Filter Set..... A-5549M-S	
D6R II (DOZERS) S/N: AAX1-UP		Air Filter Set..... A-5549M-S		Hydraulic Oil Filter..... HC-55290	
Air Filter Set..... A-5549M-S		Hydraulic Oil Filter..... H-5510		Hydraulic Oil Filter..... H-5526	
Air Filter Secondary..... A-5550		Hydraulic Oil Filter..... HC-55290		Hydraulic Oil Filter..... H-55280	
Air Filter Primary..... A-5549		Hydraulic Oil Filter..... H-5526		Hydraulic Oil Filter..... H-55280	
D6R II (DOZERS) S/N: AGM1-UP		Hydraulic Oil Filter..... H-55280		D6R II (DOZERS) S/N: BPM1-UP	
Air Filter Set..... A-5549M-S		D6R II (DOZERS) S/N: AGM1-UP		Air Filter Set..... A-5549M-S	
D6R II (DOZERS) S/N: AGM1-UP		Air Filter Set..... A-5549M-S		Air Filter Secondary..... A-5550	
Air Filter Set..... A-5549M-S		Air Filter Secondary..... A-5550		Air Filter Primary..... A-5549	
Air Filter Secondary..... A-5550		Air Filter Primary..... A-5549M		Air Filter Primary..... A-5549M	
Air Filter Primary..... A-5549		Hydraulic Oil Filter..... H-55280		Hydraulic Oil Filter..... H-55280	

MODEL/APPLICATION	SAKURA NO	MODEL/APPLICATION	SAKURA NO	MODEL/APPLICATION	SAKURA NO
CATERPILLAR		CATERPILLAR		CATERPILLAR	
D6R II (DOZERS) S/N: BPM1-UP Hydraulic Oil Filter..... H-5526 Hydraulic Oil Filter..... HC-55290		D6R III (DOZERS) S/N: DMK1-UP Air Filter Set..... A-5549M-S Air Filter Secondary..... A-5550 Air Filter Primary..... A-5549 Air Filter Primary..... A-5549M Hydraulic Oil Filter..... H-5510		D6R III (DOZERS) S/N: LFM1-UP Air Filter Primary..... A-5549M Air Filter Secondary..... A-5550 Air Filter Primary..... A-5549 Air Filter Set..... A-5549M-S Hydraulic Oil Filter..... H-5510	
D6R II (DOZERS) S/N: BRJ1-UP Air Filter Primary..... A-5549 Air Filter Secondary..... A-5550 Air Filter Set..... A-5549M-S Air Filter Primary..... A-5549M Hydraulic Oil Filter..... H-5526 Hydraulic Oil Filter..... H-55280 Hydraulic Oil Filter..... HC-55290		D6R III (DOZERS) S/N: DPS1-UP Air Filter Primary..... A-5549M Air Filter Primary..... A-5549 Air Filter Secondary..... A-5550 Air Filter Set..... A-5549M-S Hydraulic Oil Filter..... H-5510		D6R III (DOZERS) S/N: MRT1-UP Air Filter Set..... A-5549M-S Air Filter Primary..... A-5549 Air Filter Secondary..... A-5550 Air Filter Primary..... A-5549M Hydraulic Oil Filter..... H-5510	
D6R II (DOZERS) S/N: CAD1-UP Air Filter Primary..... A-5549M Air Filter Set..... A-5549M-S Air Filter Secondary..... A-5550 Air Filter Primary..... A-5549 Hydraulic Oil Filter..... H-55280 Hydraulic Oil Filter..... H-5526 Hydraulic Oil Filter..... HC-55290		D6R III (DOZERS) S/N: GJB1-UP Air Filter Primary..... A-5549M Air Filter Secondary..... A-5550 Air Filter Primary..... A-5549 Air Filter Set..... A-5549M-S Hydraulic Oil Filter..... H-5510		D6R III (DOZERS) S/N: MTJ1-UP Air Filter Primary..... A-5549M Air Filter Secondary..... A-5550 Air Filter Primary..... A-5549 Air Filter Set..... A-5549M-S Hydraulic Oil Filter..... H-5510	
D6R II (DOZERS) S/N: DAE1-UP Air Filter Primary..... A-5549M Air Filter Primary..... A-5549 Air Filter Secondary..... A-5550 Air Filter Set..... A-5549M-S Hydraulic Oil Filter..... HC-55290 Hydraulic Oil Filter..... H-5526 Hydraulic Oil Filter..... H-55280		D6R III (DOZERS) S/N: GMT1-UP Air Filter Set..... A-5549M-S Air Filter Primary..... A-5549 Air Filter Secondary..... A-5550 Air Filter Primary..... A-5549M Hydraulic Oil Filter..... H-5510		D6R III (DOZERS) S/N: RFC1-UP Air Filter Set..... A-5549M-S Air Filter Primary..... A-5549 Air Filter Secondary..... A-5550 Air Filter Primary..... A-5549M Hydraulic Oil Filter..... H-5510	
D6R II (DOZERS) S/N: FDT1-UP Air Filter Primary..... A-5549M Air Filter Set..... A-5549M-S Air Filter Secondary..... A-5550 Air Filter Primary..... A-5549 Hydraulic Oil Filter..... H-55280 Hydraulic Oil Filter..... H-5526 Hydraulic Oil Filter..... HC-55290		D6R III (DOZERS) S/N: HCD1-UP Air Filter Primary..... A-5549M Air Filter Secondary..... A-5550 Air Filter Primary..... A-5549 Air Filter Set..... A-5549M-S Hydraulic Oil Filter..... H-5510		D6R III (DOZERS) S/N: TBC1-UP Air Filter Primary..... A-5549M Air Filter Secondary..... A-5550 Air Filter Primary..... A-5549 Air Filter Set..... A-5549M-S Hydraulic Oil Filter..... H-5510	
D6R III (DOZERS) CAT S/N: THX1-UP Fuel Filter..... FC-5517		D6R III (DOZERS) S/N: HDC1-UP Air Filter Set..... A-5549M-S Air Filter Primary..... A-5549 Air Filter Secondary..... A-5550 Air Filter Primary..... A-5549M Hydraulic Oil Filter..... H-5510		D6R III (DOZERS) S/N: WCB1-UP Air Filter Set..... A-5549M-S Air Filter Primary..... A-5549 Air Filter Secondary..... A-5550 Air Filter Primary..... A-5549M Hydraulic Oil Filter..... H-5510	
D6R III (DOZERS) CAT S/N: THY1-UP Fuel Filter..... FC-5517		D6R III (DOZERS) S/N: HKE1-UP Air Filter Primary..... A-5549M Air Filter Secondary..... A-5550 Air Filter Primary..... A-5549 Air Filter Set..... A-5549M-S Hydraulic Oil Filter..... H-5510		D6R III (DOZERS) S/N: WRG1-UP Air Filter Primary..... A-5549M Air Filter Secondary..... A-5550 Air Filter Primary..... A-5549 Air Filter Set..... A-5549M-S Hydraulic Oil Filter..... H-5510	
D6R III (DOZERS) CAT C9 ACERT Cabin Air Filter..... CA-55140		D6R III (DOZERS) S/N: JDL1-UP Air Filter Set..... A-5549M-S Air Filter Primary..... A-5549 Air Filter Secondary..... A-5550 Air Filter Primary..... A-5549M Hydraulic Oil Filter..... H-5510		D6R III (DOZERS) S/N: WCB1-UP Air Filter Set..... A-5549M-S Air Filter Primary..... A-5549 Air Filter Secondary..... A-5550 Air Filter Primary..... A-5549M Hydraulic Oil Filter..... H-5510	
D6R III (DOZERS) S/N: DLM1-UP Air Filter Set..... A-5549M-S Air Filter Primary..... A-5549M Air Filter Primary..... A-5549 Air Filter Secondary..... A-5550 Hydraulic Oil Filter..... H-5510		D6R III (DOZERS) S/N: JDL1-UP Air Filter Set..... A-5549M-S Air Filter Primary..... A-5549 Air Filter Secondary..... A-5550 Air Filter Primary..... A-5549M Hydraulic Oil Filter..... H-5510		D6R LGP (DOZERS) CAT 3306 Cabin Air Filter..... CA-55140	
				D6R LGP (DOZERS) CAT 3306T Fuel Filter Secondary..... FC-5504 Oil Filter Full Flow..... C-5516	

MODEL/APPLICATION	SAKURA NO	MODEL/APPLICATION	SAKURA NO	MODEL/APPLICATION	SAKURA NO
CATERPILLAR		CATERPILLAR		CATERPILLAR	
D6R XL (DOZERS) CAT 3306		D6T (DOZERS) CAT C9 ACERT		Air Filter Primary.....	A-5509
Air Filter Set.....	A-5549M-S	Cabin Air Filter.....	CA-55140	Air Filter Secondary.....	A-5522
Air Filter Secondary.....	A-5550			Air Filter Set.....	A-5522-S
Air Filter Primary.....	A-5549	D6T (DOZERS) w/C9 Eng.		Hydraulic Oil Filter.....	H-5503
Air Filter Primary.....	A-5549M	Fuel/Water Separator.....	SFC-55170	Hydraulic Oil Filter.....	H-5506
Cabin Air Filter.....	CA-55140			Oil Filter Full Flow.....	C-5510
Fuel Filter.....	F-5505	D6T LGP (DOZERS) CAT C9.3 ACERT			
Fuel Filter Secondary.....	FC-5507	Cabin Air Filter.....	CA-55140	D7 (DOZERS) S/N: 65V1-UP	
Hydraulic Oil Filter.....	H-5510			Air Filter Primary.....	A-5549M
Oil Filter Full Flow.....	C-5510	D6T LGP (DOZERS) w/C9 Eng.		Air Filter Set.....	A-5522-S
		Fuel/Water Separator.....	SFC-55170	Air Filter Secondary.....	A-5522
D6R XL (DOZERS) w/C9 Eng.		D6T LGP (DOZERS) W/C9.3L ENG.		Air Filter Primary.....	A-5509
Fuel/Water Separator.....	SFC-55170	Fuel/Water Separator.....	SFC-55250	Air Filter Set.....	A-5549M-S
D6R XW (DOZERS) CAT C9 (S/N: DMP1-UP)		D6T XL (DOZERS) CAT C9.3 ACERT		Air Filter Secondary.....	A-5550
Air Filter Primary.....	A-5549M	Cabin Air Filter.....	CA-55140	Air Filter Primary.....	A-5549
Air Filter Primary.....	A-5549			Hydraulic Oil Filter.....	H-5506
Air Filter Secondary.....	A-5550	D6T XL (DOZERS) w/C9 Eng.		Hydraulic Oil Filter.....	H-5503
Air Filter Set.....	A-5549M-S	Fuel/Water Separator.....	SFC-55170	Oil Filter Full Flow.....	C-5510
Fuel Filter Secondary.....	FC-5507				
Hydraulic Oil Filter.....	H-5510	D6T XL (DOZERS) W/C9.3L ENG.		D7 (DOZERS) S/N: 93N1-961	
Hydraulic Oil Filter.....	H-5526	Fuel/Water Separator.....	SFC-55250	Air Filter Primary.....	A-5549M
Oil Filter Full Flow.....	C-5510	D6T XW (DOZERS) CAT C9.3 ACERT		Air Filter Primary.....	A-5549
		Cabin Air Filter.....	CA-55140	Air Filter Secondary.....	A-5550
D6R2 (DOZERS) CAT C9		D6T XW (DOZERS) w/C9 Eng.		Air Filter Set.....	A-5549M-S
Fuel Filter.....	FC-5517	Fuel/Water Separator.....	SFC-55170	Air Filter Primary.....	A-5509
Hydraulic Oil Filter.....	H-5526			Air Filter Secondary.....	A-5522
		D6T XW (DOZERS) W/C9.3L ENG.		Air Filter Set.....	A-5522-S
D6R DS (DOZERS) w/C9 Eng.		Fuel/Water Separator.....	SFC-55250	Air Filter Primary.....	A-5549
Fuel/Water Separator.....	SFC-55170	D6T XL PAT (DOZERS) W/C9.3L ENG.		Air Filter Secondary.....	A-5522
D6R FTC (DOZERS) w/C9 Eng.		Fuel/Water Separator.....	SFC-55250	Air Filter Set.....	A-5549M-S
Fuel/Water Separator.....	SFC-55170	D6T XW PAT (DOZERS) W/C9.3L ENG.		Air Filter Secondary.....	A-5550
D6R II LGP (DOZERS) CAT C9		Fuel/Water Separator.....	SFC-55250	Air Filter Primary.....	A-5549
Cabin Air Filter.....	CA-55140	D6T XL PAT (DOZERS) W/C9.3L ENG.		Air Filter Primary.....	A-5549M
D6R II XL (DOZERS) CAT C9		Fuel/Water Separator.....	SFC-55250	Hydraulic Oil Filter.....	H-5503
Cabin Air Filter.....	CA-55140	D6T XW PAT (DOZERS) W/C9.3L ENG.		Oil Filter Full Flow.....	O-5502
D6R II XW (DOZERS) CAT C9		Fuel/Water Separator.....	SFC-55250		
Cabin Air Filter.....	CA-55140	D7 (DOZERS) Excluding S/N: 94N3347, 94N3352		D7C (TRACTORS)	
D6R III LGP (DOZERS) CAT C9 ACERT		Air Filter Set.....	A-5549M-S	Fuel Filter.....	F-5501
Cabin Air Filter.....	CA-55140	Air Filter Secondary.....	A-5550	Oil Filter Full Flow.....	O-5502
D6R III XL (DOZERS) CAT C9 ACERT		Air Filter Primary.....	A-5549		
Cabin Air Filter.....	CA-55140	Air Filter Primary.....	A-5549M	D7E (DOZERS) S/N: 47A1-3395	
D6R III XW (DOZERS) CAT C9 ACERT		D7 (DOZERS) S/N: 45W1-UP		Fuel Filter.....	F-5501
Cabin Air Filter.....	CA-55140	Air Filter Primary.....	A-5549M	Hydraulic Oil Filter.....	H-5504
D6R XR (DOZERS) CAT 3306		Air Filter Primary.....	A-5549	Oil Filter Full Flow.....	O-5503
Cabin Air Filter.....	CA-55140	Air Filter Secondary.....	A-5550		
		Air Filter Set.....	A-5549M-S	D7E (DOZERS) S/N: 47A3678-UP	
				Air Filter Set.....	A-5514-S
				Air Filter Primary.....	A-5514

Sakura Filter

ENGINE APPLICATION

MODEL/APPLICATION	SAKURA NO
CATERPILLAR	
D7E (DOZERS) S/N: 47A3678-UP	
Fuel Filter.....	F-5501
Hydraulic Oil Filter.....	H-5503
Oil Filter Full Flow.....	O-5503
D7E (DOZERS) S/N: 48A1-6392	
Fuel Filter.....	F-5501
Hydraulic Oil Filter.....	H-5504
Oil Filter Full Flow.....	O-5503
D7E (DOZERS) W/C9.3L ENG.	
Air Filter Primary.....	A-5535M
Air Filter Set.....	A-5573M-S
Fuel/Water Separator.....	SFC-55250
Fuel/Water Separator.....	SFC-55170
D7E LGP (DOZERS) W/C9.3L ENG.	
Fuel/Water Separator.....	SFC-55250
D7F (DOZERS)	
Fuel Filter.....	F-5503
D7F (DOZERS) S/N: 93N1-1174	
Air Filter Primary.....	A-5549
Air Filter Set.....	A-5522-S
Air Filter Secondary.....	A-5522
Air Filter Secondary.....	A-5550
Air Filter Set.....	A-5549M-S
Air Filter Primary.....	A-5549M
Air Filter Primary.....	A-5509
Hydraulic Oil Filter.....	H-5503
Oil Filter Full Flow.....	C-5510
D7F (DOZERS) S/N: 93N1175-UP	
Air Filter Primary.....	A-5549M
Air Filter Set.....	A-5549M-S
Air Filter Secondary.....	A-5550
Air Filter Secondary.....	A-5522
Air Filter Set.....	A-5522-S
Air Filter Primary.....	A-5549
Air Filter Primary.....	A-5509
Hydraulic Oil Filter.....	H-5503
Oil Filter Full Flow.....	C-5510
D7F (DOZERS) S/N: 94N1-5191	
Air Filter Primary.....	A-5549
Air Filter Secondary.....	A-5522
Air Filter Secondary.....	A-5550
Air Filter Set.....	A-5549M-S
Air Filter Primary.....	A-5549M
Fuel Filter Secondary.....	FC-5507
Hydraulic Oil Filter.....	H-5503
Oil Filter Full Flow.....	C-5510
D7F (DOZERS) S/N: 94N5192-UP	
Air Filter Set.....	A-5522-S

MODEL/APPLICATION	SAKURA NO
CATERPILLAR	
Air Filter Primary.....	A-5549
Air Filter Primary.....	A-5509
Air Filter Primary.....	A-5549M
Air Filter Set.....	A-5549M-S
Air Filter Secondary.....	A-5550
Air Filter Secondary.....	A-5522
Fuel Filter Secondary.....	FC-5507
Hydraulic Oil Filter.....	H-5503
Oil Filter Full Flow.....	C-5510
D7G II (DOZERS) CAT 3306 DITA	
Cabin Air Filter.....	CA-55140
D7G (DOZERS) CAT 3306T	
Fuel Filter.....	F-5503
D7G (DOZERS) CAT 3306T (S/N: 35N1-UP)	
Air Filter Set.....	A-5522-S
Air Filter Secondary.....	A-5510
Air Filter Primary.....	A-5509
Fuel Filter Secondary.....	FC-5507
Hydraulic Oil Filter.....	H-5506
Hydraulic Oil Filter.....	H-5526
Hydraulic Oil Filter.....	H-55280
Hydraulic Oil Filter.....	H-5503
Oil Filter Full Flow.....	C-5510
D7G (DOZERS) CAT 3306T (S/N: 3GF1-UP)	
Air Filter Primary.....	A-5509
Air Filter Set.....	A-5522-S
Air Filter Secondary.....	A-5522
Fuel Filter Secondary.....	FC-5507
Fuel Filter.....	F-5505
Hydraulic Oil Filter.....	H-5503
Hydraulic Oil Filter.....	H-55280
Hydraulic Oil Filter.....	H-5526
Hydraulic Oil Filter.....	H-5506
Oil Filter Full Flow.....	C-5510
D7G (DOZERS) CAT 3306T (S/N: 3ZD1-UP)	
Air Filter Secondary.....	A-5522
Air Filter Set.....	A-5522-S
Air Filter Primary.....	A-5509
Fuel Filter Secondary.....	FC-5507
Fuel Filter.....	F-5505
Hydraulic Oil Filter.....	H-5503
Hydraulic Oil Filter.....	H-5506
Hydraulic Oil Filter.....	H-5526
Hydraulic Oil Filter.....	H-55280
Oil Filter Full Flow.....	C-5510
D7G (DOZERS) CAT 3306T (S/N: 44W1-440)	
Air Filter Primary.....	A-5509
Air Filter Set.....	A-5522-S
Air Filter Secondary.....	A-5522
Hydraulic Oil Filter.....	H-5503
Oil Filter Full Flow.....	C-5510

MODEL/APPLICATION	SAKURA NO
CATERPILLAR	
D7G (DOZERS) CAT 3306T (S/N: 44W441-UP)	
Air Filter Secondary.....	A-5522
Air Filter Set.....	A-5522-S
Air Filter Primary.....	A-5509
Fuel Filter.....	F-5505
Fuel Filter Secondary.....	FC-5507
Hydraulic Oil Filter.....	H-55280
Hydraulic Oil Filter.....	H-5526
Hydraulic Oil Filter.....	H-5506
Hydraulic Oil Filter.....	H-5503
Oil Filter Full Flow.....	C-5510
D7G (DOZERS) CAT 3306T (S/N: 45W407-UP)	
Air Filter Primary.....	A-5509
Air Filter Set.....	A-5522-S
Air Filter Secondary.....	A-5522
Fuel Filter Secondary.....	FC-5507
Fuel Filter.....	F-5505
Hydraulic Oil Filter.....	H-5506
Oil Filter Full Flow.....	C-5510
D7G (DOZERS) CAT 3306T (S/N: 65V1-UP)	
Air Filter Set.....	A-5549M-S
Air Filter Secondary.....	A-5550
Air Filter Secondary.....	A-5522
Air Filter Set.....	A-5522-S
Air Filter Primary.....	A-5509
Air Filter Primary.....	A-5549
Air Filter Primary.....	A-5549M
Hydraulic Oil Filter.....	H-5503
Hydraulic Oil Filter.....	H-5506
Oil Filter Full Flow.....	C-5510
D7G (DOZERS) CAT 3306T (S/N: 72W1-UP)	
Air Filter Primary.....	A-5549M
Air Filter Primary.....	A-5549
Air Filter Primary.....	A-5509
Air Filter Set.....	A-5522-S
Air Filter Secondary.....	A-5522
Air Filter Secondary.....	A-5550
Air Filter Set.....	A-5549M-S
Fuel Filter.....	F-5505
Hydraulic Oil Filter.....	H-5503
Oil Filter Full Flow.....	C-5510
D7G (DOZERS) CAT 3306T (S/N: 91V1-UP)	
Air Filter Set.....	A-5549M-S
Air Filter Secondary.....	A-5550
Air Filter Secondary.....	A-5522
Air Filter Set.....	A-5522-S
Air Filter Primary.....	A-5509
Air Filter Primary.....	A-5549
Air Filter Primary.....	A-5549M
Hydraulic Oil Filter.....	H-5503
D7G (DOZERS) CAT 3306T (S/N: 92V1-UP)	
Air Filter Secondary.....	A-5550

MODEL/APPLICATION	SAKURA NO
CATERPILLAR	
D7G (DOZERS) CAT 3306T (S/N: 92V1-UP)	
Air Filter Set.....	A-5549M-S
Air Filter Primary.....	A-5549M
Air Filter Primary.....	A-5549
Air Filter Primary.....	A-5509
Air Filter Set.....	A-5522-S
Air Filter Secondary.....	A-5522
Fuel Filter.....	F-5505
Hydraulic Oil Filter.....	H-5503
Oil Filter Full Flow.....	C-5510
D7G (DOZERS) CAT 3306T (S/N: 93N962-UP)	
Air Filter Set.....	A-5549M-S
Air Filter Secondary.....	A-5550
Air Filter Secondary.....	A-5522
Air Filter Set.....	A-5522-S
Air Filter Primary.....	A-5509
Air Filter Primary.....	A-5549
Air Filter Primary.....	A-5549M
Fuel Filter.....	F-5505
Hydraulic Oil Filter.....	H-5503
Oil Filter Full Flow.....	C-5510
D7G (DOZERS) CAT 3306T (S/N: 94N3357-UP)	
Air Filter Secondary.....	A-5550
Air Filter Set.....	A-5549M-S
Air Filter Primary.....	A-5549M
Air Filter Primary.....	A-5549
Air Filter Primary.....	A-5509
Air Filter Set.....	A-5522-S
Air Filter Secondary.....	A-5522
Fuel Filter.....	F-5505
Hydraulic Oil Filter.....	H-5503
Oil Filter Full Flow.....	C-5510
D7G (DOZERS) CAT 3606	
Air Filter Secondary.....	A-5522
Air Filter Set.....	A-5522-S
Air Filter Primary.....	A-5509
Air Filter Primary.....	A-5549
Air Filter Primary.....	A-5549M
Air Filter Set.....	A-5549M-S
Air Filter Secondary.....	A-5550
Hydraulic Oil Filter.....	H-5503
Oil Filter Full Flow.....	C-5510
D7G LGP (DOZERS) S/N: 44W1-547	
Air Filter Primary.....	A-5509
Air Filter Set.....	A-5522-S
Air Filter Secondary.....	A-5522
Fuel Filter Secondary.....	FC-5507
Hydraulic Oil Filter.....	H-55280
Hydraulic Oil Filter.....	H-5503
Hydraulic Oil Filter.....	H-5526
Oil Filter Full Flow.....	C-5510
D7G LGP (DOZERS) S/N: 45W1-UP	
Air Filter Primary.....	A-5509

MODEL/APPLICATION	SAKURA NO
CATERPILLAR	
Air Filter Secondary.....	A-5522
Air Filter Set.....	A-5522-S
Fuel Filter Secondary.....	FC-5507
Hydraulic Oil Filter.....	H-5503
Hydraulic Oil Filter.....	H-55280
Hydraulic Oil Filter.....	H-5526
Oil Filter Full Flow.....	C-5510
D7G SERIES II (DOZERS) w/3306 Eng.	
Air Filter Primary.....	A-5535M
Air Filter Set.....	A-5573M-S
D7H (DOZERS) CAT 3306	
Cabin Air Filter.....	CA-55140
D7H (DOZERS) S/N: 2RG1-UP	
Air Filter Secondary.....	A-5522
Air Filter Set.....	A-5522-S
Air Filter Primary.....	A-5509
Fuel Filter Secondary.....	FC-5507
Fuel Filter.....	F-5505
Hydraulic Oil Filter.....	H-5526
Hydraulic Oil Filter.....	H-5503
Hydraulic Oil Filter.....	H-55280
Oil Filter Full Flow.....	C-5510
D7H (DOZERS) S/N: 25B1-UP	
Air Filter Primary.....	A-5509
Air Filter Set.....	A-5522-S
Air Filter Secondary.....	A-5522
Fuel Filter Secondary.....	FC-5507
Fuel Filter.....	F-5505
Hydraulic Oil Filter.....	H-5503
Hydraulic Oil Filter.....	H-5526
Hydraulic Oil Filter.....	H-55280
Hydraulic Oil Filter.....	H-5510
Oil Filter Full Flow.....	C-5510
D7H (DOZERS) S/N: 3XG1-UP	
Air Filter Secondary.....	A-5522
Air Filter Set.....	A-5522-S
Air Filter Primary.....	A-5509
Fuel Filter.....	F-5505
Fuel Filter Secondary.....	FC-5507
Hydraulic Oil Filter.....	H-5526
Hydraulic Oil Filter.....	H-55280
Hydraulic Oil Filter.....	H-5503
Oil Filter Full Flow.....	C-5510
D7H (DOZERS) S/N: 4AB1-UP	
Air Filter Primary.....	A-5509
Air Filter Set.....	A-5522-S
Air Filter Secondary.....	A-5522
Fuel Filter.....	F-5505
Fuel Filter Secondary.....	FC-5507
Hydraulic Oil Filter.....	H-5503
Hydraulic Oil Filter.....	H-55280
Hydraulic Oil Filter.....	H-5510

MODEL/APPLICATION	SAKURA NO
CATERPILLAR	
Hydraulic Oil Filter.....	H-5526
Oil Filter Full Flow.....	C-5510
D7H (DOZERS) S/N: 4AB5500-UP	
Air Filter Secondary.....	A-5550
Air Filter Set.....	A-5549M-S
Air Filter Primary.....	A-5549M
Air Filter Primary.....	A-5549
Fuel Filter Secondary.....	FC-5507
Hydraulic Oil Filter.....	H-5503
Hydraulic Oil Filter.....	H-5510
Oil Filter Full Flow.....	C-5510
D7H (DOZERS) S/N: 4FG1-328	
Air Filter Primary.....	A-5509
Air Filter Secondary.....	A-5522
Air Filter Set.....	A-5522-S
Hydraulic Oil Filter.....	H-55280
Hydraulic Oil Filter.....	H-5503
Hydraulic Oil Filter.....	H-5526
D7H (DOZERS) S/N: 4FG1-UP	
Air Filter Set.....	A-5522-S
Air Filter Secondary.....	A-5522
Air Filter Primary.....	A-5509
Fuel Filter.....	F-5505
Fuel Filter Secondary.....	FC-5507
Hydraulic Oil Filter.....	H-55280
Hydraulic Oil Filter.....	H-5526
Hydraulic Oil Filter.....	H-5503
Oil Filter Full Flow.....	C-5510
D7H (DOZERS) S/N: 4FG329-5499	
Air Filter Primary.....	A-5509
Air Filter Secondary.....	A-5522
Air Filter Set.....	A-5522-S
Hydraulic Oil Filter.....	H-5503
Hydraulic Oil Filter.....	H-5526
Hydraulic Oil Filter.....	H-55280
D7H (DOZERS) S/N: 4FG4000-UP	
Air Filter Primary.....	A-5549
Air Filter Primary.....	A-5549M
Air Filter Primary.....	A-5535
Air Filter Secondary.....	A-5534
Air Filter Set.....	A-5573-S
Air Filter Set.....	A-5549M-S
Air Filter Secondary.....	A-5550
Fuel Filter.....	F-5505
Fuel Filter Secondary.....	FC-5507
Hydraulic Oil Filter.....	H-5526
Hydraulic Oil Filter.....	H-5503
Hydraulic Oil Filter.....	H-55280
Oil Filter Full Flow.....	C-5510
D7H (DOZERS) S/N: 4FG5500-5631	
Air Filter Secondary.....	A-5550
Air Filter Set.....	A-5549M-S
Air Filter Primary.....	A-5549M

Sakura Filter

ENGINE APPLICATION

MODEL/APPLICATION	SAKURA NO	MODEL/APPLICATION	SAKURA NO	MODEL/APPLICATION	SAKURA NO
CATERPILLAR		CATERPILLAR		CATERPILLAR	
D7H (DOZERS) S/N: 4FG5500-5631 Air Filter Primary..... A-5549 Hydraulic Oil Filter..... H-5503 Hydraulic Oil Filter..... H-5526 Hydraulic Oil Filter..... H-55280		Hydraulic Oil Filter..... H-5503 D7H (DOZERS) S/N: 5BF614-5499 Air Filter Primary..... A-5509 Air Filter Set..... A-5522-S Air Filter Secondary..... A-5522 Hydraulic Oil Filter..... H-55280 Hydraulic Oil Filter..... H-5503 Hydraulic Oil Filter..... H-5526		Air Filter Set..... A-5522-S Air Filter Secondary..... A-5522 Air Filter Primary..... A-5509 Hydraulic Oil Filter..... H-5506 Hydraulic Oil Filter..... H-5526 Hydraulic Oil Filter..... H-55280	
D7H (DOZERS) S/N: 4FG5632-UP Air Filter Set..... A-5573-S Air Filter Secondary..... A-5534 Air Filter Primary..... A-5535 Hydraulic Oil Filter..... H-55280 Hydraulic Oil Filter..... H-5526 Hydraulic Oil Filter..... H-5503		Hydraulic Oil Filter..... H-5526 Hydraulic Oil Filter..... H-5503 D7H (DOZERS) S/N: 5WB1-UP Air Filter Secondary..... A-5522 Air Filter Set..... A-5522-S Air Filter Primary..... A-5509 Fuel Filter..... F-5505 Fuel Filter Secondary..... FC-5507 Hydraulic Oil Filter..... H-55280 Hydraulic Oil Filter..... H-5510 Hydraulic Oil Filter..... H-5526 Hydraulic Oil Filter..... H-5503 Oil Filter Full Flow..... C-5510		D7H (DOZERS) S/N: 792305-2315 Air Filter Primary..... A-5509 Air Filter Secondary..... A-5522 Air Filter Set..... A-5522-S Hydraulic Oil Filter..... H-55280 Hydraulic Oil Filter..... H-5526	
D7H (DOZERS) S/N: 5BF1-3999 Air Filter Primary..... A-5509 Air Filter Set..... A-5522-S Air Filter Secondary..... A-5522 Fuel Filter Secondary..... FC-5507 Fuel Filter..... F-5505 Hydraulic Oil Filter..... H-5526 Hydraulic Oil Filter..... H-55280 Hydraulic Oil Filter..... H-5503 Oil Filter Full Flow..... C-5510		D7H (DOZERS) S/N: 5WB5500-UP Air Filter Secondary..... A-5550 Fuel Filter Secondary..... FC-5507 Hydraulic Oil Filter..... H-5503 Hydraulic Oil Filter..... H-5510 Hydraulic Oil Filter..... H-5510 Oil Filter Full Flow..... C-5510		D7H (DOZERS) S/N: 792316-5499 Air Filter Set..... A-5522-S Air Filter Secondary..... A-5522 Air Filter Primary..... A-5509 Hydraulic Oil Filter..... H-5526 Hydraulic Oil Filter..... H-5506 Hydraulic Oil Filter..... H-55280	
D7H (DOZERS) S/N: 5BF1-613 Air Filter Secondary..... A-5522 Air Filter Set..... A-5522-S Air Filter Primary..... A-5509 Hydraulic Oil Filter..... H-55280 Hydraulic Oil Filter..... H-5526 Hydraulic Oil Filter..... H-5503		D7H (DOZERS) S/N: 7721-UP Air Filter Primary..... A-5509 Air Filter Set..... A-5522-S Air Filter Secondary..... A-5522 Fuel Filter..... F-5505 Fuel Filter Secondary..... FC-5507 Hydraulic Oil Filter..... H-5510 Hydraulic Oil Filter..... H-55280 Hydraulic Oil Filter..... H-5526 Hydraulic Oil Filter..... H-5503 Oil Filter Full Flow..... C-5510		D7H (DOZERS) S/N: 7924000-UP Air Filter Primary..... A-5549M Air Filter Primary..... A-5549 Air Filter Set..... A-5573-S Air Filter Secondary..... A-5534 Air Filter Primary..... A-5535 Air Filter Set..... A-5549M-S Air Filter Secondary..... A-5550 Fuel Filter..... F-5505 Fuel Filter Secondary..... FC-5507 Hydraulic Oil Filter..... H-5503 Hydraulic Oil Filter..... H-5526 Hydraulic Oil Filter..... H-5506 Hydraulic Oil Filter..... H-55280 Oil Filter Full Flow..... C-5510	
D7H (DOZERS) S/N: 5BF4000-UP Air Filter Primary..... A-5549 Air Filter Primary..... A-5549M Air Filter Set..... A-5549M-S Air Filter Secondary..... A-5550 Fuel Filter Secondary..... FC-5507 Hydraulic Oil Filter..... H-5503 Oil Filter Full Flow..... C-5510		D7H (DOZERS) S/N: 7921-3999 Air Filter Primary..... A-5549 Air Filter Primary..... A-5549M Air Filter Secondary..... A-5522 Air Filter Secondary..... A-5550 Air Filter Set..... A-5549M-S Fuel Filter Secondary..... FC-5507 Hydraulic Oil Filter..... H-5503 Hydraulic Oil Filter..... H-5510 Hydraulic Oil Filter..... H-5503 Oil Filter Full Flow..... C-5510		D7H (DOZERS) S/N: 7925500-5925 Air Filter Secondary..... A-5550 Air Filter Set..... A-5549M-S Air Filter Primary..... A-5549 Air Filter Primary..... A-5549M Hydraulic Oil Filter..... H-5526 Hydraulic Oil Filter..... H-5506 Hydraulic Oil Filter..... H-55280	
D7H (DOZERS) S/N: 5BF5500-6032 Air Filter Secondary..... A-5550 Air Filter Set..... A-5549M-S Air Filter Primary..... A-5549M Air Filter Primary..... A-5549 Hydraulic Oil Filter..... H-5503 Hydraulic Oil Filter..... H-5526 Hydraulic Oil Filter..... H-55280		D7H (DOZERS) S/N: 7921-744 Air Filter Primary..... A-5509 Air Filter Secondary..... A-5522 Air Filter Set..... A-5522-S		D7H (DOZERS) S/N: 7925926-UP Air Filter Primary..... A-5535 Air Filter Secondary..... A-5534 Air Filter Set..... A-5573-S Hydraulic Oil Filter..... H-55280 Hydraulic Oil Filter..... H-5506 Hydraulic Oil Filter..... H-5526	
D7H (DOZERS) S/N: 5BF6033-UP Air Filter Primary..... A-5535 Air Filter Secondary..... A-5534 Air Filter Set..... A-5573-S Hydraulic Oil Filter..... H-55280 Hydraulic Oil Filter..... H-5526		D7H (DOZERS) S/N: 7921-2304 Air Filter Primary..... A-5509 Air Filter Secondary..... A-5522 Air Filter Set..... A-5522-S		D7H (DOZERS) S/N: 792745-2303 Air Filter Primary..... A-5509 Air Filter Secondary..... A-5522 Air Filter Set..... A-5522-S	

MODEL/APPLICATION	SAKURA NO
-------------------	-----------

CATERPILLAR

D7H
(DOZERS)
S/N: 79Z745-2303

Hydraulic Oil Filter..... H-5526
Hydraulic Oil Filter..... H-55280

D7H
(DOZERS)
S/N: 79ZF-3999

Air Filter Set..... A-5522-S
Air Filter Secondary..... A-5522
Air Filter Primary..... A-5509
Fuel Filter..... F-5505
Fuel Filter Secondary..... FC-5507
Hydraulic Oil Filter..... H-5503
Hydraulic Oil Filter..... H-55280
Hydraulic Oil Filter..... H-5510
Hydraulic Oil Filter..... H-5526
Hydraulic Oil Filter..... H-5506
Oil Filter Full Flow..... C-5510

D7H
(DOZERS)
S/N: 80Z1-3999

Air Filter Primary..... A-5509
Air Filter Secondary..... A-5522
Air Filter Set..... A-5522-S
Fuel Filter Secondary..... FC-5507
Fuel Filter..... F-5505
Hydraulic Oil Filter..... H-5506
Hydraulic Oil Filter..... H-5526
Hydraulic Oil Filter..... H-5510
Hydraulic Oil Filter..... H-5503
Hydraulic Oil Filter..... H-55280
Oil Filter Full Flow..... C-5510

D7H
(DOZERS)
S/N: 80Z1-640

Air Filter Set..... A-5522-S
Air Filter Secondary..... A-5522
Air Filter Primary..... A-5509

D7H
(DOZERS)
S/N: 80Z4000-UP

Air Filter Set..... A-5549M-S
Air Filter Secondary..... A-5550
Air Filter Set..... A-5573-S
Air Filter Secondary..... A-5534
Air Filter Primary..... A-5535
Air Filter Primary..... A-5549M
Air Filter Primary..... A-5549
Fuel Filter..... F-5505
Fuel Filter Secondary..... FC-5507
Hydraulic Oil Filter..... H-5503
Hydraulic Oil Filter..... H-55280
Hydraulic Oil Filter..... H-5526
Hydraulic Oil Filter..... H-5506
Oil Filter Full Flow..... C-5510

D7H
(DOZERS)
S/N: 80Z5500-5525

Air Filter Primary..... A-5549
Air Filter Primary..... A-5549M
Air Filter Secondary..... A-5550
Air Filter Set..... A-5549M-S
Hydraulic Oil Filter..... H-5506

MODEL/APPLICATION	SAKURA NO
-------------------	-----------

CATERPILLAR

Hydraulic Oil Filter..... H-5526
Hydraulic Oil Filter..... H-55280

D7H
(DOZERS)
S/N: 80Z5526-UP

Air Filter Primary..... A-5535
Air Filter Secondary..... A-5534
Air Filter Set..... A-5573-S
Hydraulic Oil Filter..... H-55280
Hydraulic Oil Filter..... H-5526
Hydraulic Oil Filter..... H-5506

D7H
(DOZERS)
S/N: 80Z641-801

Air Filter Primary..... A-5509
Air Filter Secondary..... A-5522
Air Filter Set..... A-5522-S
Hydraulic Oil Filter..... H-5526
Hydraulic Oil Filter..... H-55280

D7H
(DOZERS)
S/N: 80Z802-5499

Air Filter Set..... A-5522-S
Air Filter Secondary..... A-5522
Air Filter Primary..... A-5509
Hydraulic Oil Filter..... H-55280
Hydraulic Oil Filter..... H-5526
Hydraulic Oil Filter..... H-5506

D7H
(DOZERS)
S/N: 82Z4000-UP

Air Filter Primary..... A-5509
Air Filter Secondary..... A-5522
Air Filter Set..... A-5522-S
Fuel Filter..... F-5505
Fuel Filter Secondary..... FC-5507
Hydraulic Oil Filter..... H-5503
Hydraulic Oil Filter..... H-5526
Hydraulic Oil Filter..... H-5510
Hydraulic Oil Filter..... H-55280
Oil Filter Full Flow..... C-5510

D7H
(DOZERS)
w/3306 Eng.

Air Filter Set..... A-5573M-S
Air Filter Primary..... A-5535M

D7H LGP
(DOZERS)
CAT 3306

Cabin Air Filter..... CA-55140

D7H LGP
(DOZERS)
S/N: 3XG1-UP

Air Filter Secondary..... A-5522
Air Filter Primary..... A-5509
Air Filter Set..... A-5522-S
Fuel Filter..... F-5505
Fuel Filter Secondary..... FC-5507
Hydraulic Oil Filter..... H-55280
Hydraulic Oil Filter..... H-5526
Hydraulic Oil Filter..... H-5503
Oil Filter Full Flow..... C-5510

D7H LGP
(DOZERS)
S/N: 4FG1-3999

Air Filter Set..... A-5522-S

MODEL/APPLICATION	SAKURA NO
-------------------	-----------

CATERPILLAR

Air Filter Primary..... A-5509
Air Filter Secondary..... A-5522
Fuel Filter Secondary..... FC-5507
Fuel Filter..... F-5505
Hydraulic Oil Filter..... H-55280
Hydraulic Oil Filter..... H-5503
Hydraulic Oil Filter..... H-5526
Oil Filter Full Flow..... C-5510

D7H LGP
(DOZERS)
S/N: 5BF1-3999

Air Filter Secondary..... A-5522
Air Filter Primary..... A-5509
Air Filter Set..... A-5522-S
Fuel Filter..... F-5505
Fuel Filter Secondary..... FC-5507
Hydraulic Oil Filter..... H-5526
Hydraulic Oil Filter..... H-5503
Hydraulic Oil Filter..... H-55280
Oil Filter Full Flow..... C-5510

D7H LGP
(DOZERS)
S/N: 79Z1-3999

Air Filter Secondary..... A-5522
Air Filter Set..... A-5522-S
Air Filter Primary..... A-5509
Fuel Filter Secondary..... FC-5507
Fuel Filter..... F-5505
Hydraulic Oil Filter..... H-5506
Hydraulic Oil Filter..... H-55280
Hydraulic Oil Filter..... H-5510
Hydraulic Oil Filter..... H-5503
Hydraulic Oil Filter..... H-5526
Oil Filter Full Flow..... C-5510

D7H LGP
(DOZERS)
S/N: 80Z1-3999

Air Filter Secondary..... A-5522
Air Filter Primary..... A-5509
Air Filter Set..... A-5522-S
Fuel Filter..... F-5505
Fuel Filter Secondary..... FC-5507
Hydraulic Oil Filter..... H-5506
Hydraulic Oil Filter..... H-5526
Hydraulic Oil Filter..... H-5503
Hydraulic Oil Filter..... H-5510
Hydraulic Oil Filter..... H-55280
Oil Filter Full Flow..... C-5510

D7H LGP
(DOZERS)
S/N: 82Z1-UP

Air Filter Secondary..... A-5522
Air Filter Set..... A-5522-S
Air Filter Primary..... A-5509
Fuel Filter Secondary..... FC-5507
Fuel Filter..... F-5505
Hydraulic Oil Filter..... H-55280
Hydraulic Oil Filter..... H-5510
Hydraulic Oil Filter..... H-5503
Hydraulic Oil Filter..... H-5526
Oil Filter Full Flow..... C-5510

D7H LGP SERIES II
(DOZERS)
CAT 3306

Sakura Filter

ENGINE APPLICATION

MODEL/APPLICATION	SAKURA NO	MODEL/APPLICATION	SAKURA NO	MODEL/APPLICATION	SAKURA NO
CATERPILLAR		CATERPILLAR		CATERPILLAR	
D7H LGP SERIES II (DOZERS) CAT 3306		Fuel Filter Secondary.....	FC-5507	Oil Filter Full Flow.....	C-5510
Cabin Air Filter.....	CA-55140	Hydraulic Oil Filter.....	H-55280	D7R (DOZERS) S/N: 3DN1-UP	
D7H LGP SERIES II (DOZERS) S/N: 4FG4000-UP		Hydraulic Oil Filter.....	H-5526	Air Filter Secondary.....	A-5534
Air Filter Secondary.....	A-5534	Hydraulic Oil Filter.....	H-5506	Air Filter Primary.....	A-5535
Air Filter Primary.....	A-5535	Hydraulic Oil Filter.....	H-5503	Air Filter Set.....	A-5573-S
Air Filter Primary.....	A-5549M	Oil Filter Full Flow.....	C-5510	Hydraulic Oil Filter.....	H-5503
Air Filter Set.....	A-5549M-S	D7H LGP SERIES II (DOZERS) S/N: 8224000-UP		Hydraulic Oil Filter.....	HC-55290
Air Filter Secondary.....	A-5550	Air Filter Secondary.....	A-5522	Hydraulic Oil Filter.....	H-55280
Air Filter Set.....	A-5573-S	Air Filter Set.....	A-5522-S	Hydraulic Oil Filter.....	H-5526
Fuel Filter Secondary.....	FC-5507	Air Filter Primary.....	A-5509	D7R (DOZERS) S/N: 3ZR1-UP	
Fuel Filter.....	F-5505	Fuel Filter Secondary.....	FC-5507	Air Filter Set.....	A-5573-S
Hydraulic Oil Filter.....	H-5503	Fuel Filter.....	F-5505	Air Filter Primary.....	A-5535
Hydraulic Oil Filter.....	H-5526	Hydraulic Oil Filter.....	H-5503	Air Filter Secondary.....	A-5534
Hydraulic Oil Filter.....	H-55280	Hydraulic Oil Filter.....	H-5526	Fuel Filter.....	F-5505
Oil Filter Full Flow.....	C-5510	Hydraulic Oil Filter.....	H-5510	Fuel Filter Secondary.....	FC-5507
D7H LGP SERIES II (DOZERS) S/N: 5BF4000-UP		Oil Filter Full Flow.....	C-5510	Hydraulic Oil Filter.....	H-5526
Air Filter Primary.....	A-5549M	D7H II (DOZERS) CAT 3306		Hydraulic Oil Filter.....	H-55280
Air Filter Primary.....	A-5549	Cabin Air Filter.....	CA-55140	Hydraulic Oil Filter.....	H-5503
Air Filter Primary.....	A-5535	D7H SERIES II (DOZERS) w/3306 Eng.		Oil Filter Full Flow.....	C-5510
Air Filter Secondary.....	A-5534	Air Filter Primary.....	A-5535M	D7R (DOZERS) S/N: 4SR1-UP	
Air Filter Set.....	A-5573-S	Air Filter Set.....	A-5573M-S	Air Filter Secondary.....	A-5534
Air Filter Secondary.....	A-5550	D7H II XR (DOZERS) CAT 3306		Air Filter Primary.....	A-5535
Air Filter Set.....	A-5549M-S	Cabin Air Filter.....	CA-55140	Air Filter Set.....	A-5573-S
Fuel Filter.....	F-5505	D7H XR (DOZERS) CAT 3306		Fuel Filter Secondary.....	FC-5507
Fuel Filter Secondary.....	FC-5507	Cabin Air Filter.....	CA-55140	Fuel Filter.....	F-5505
Hydraulic Oil Filter.....	H-55280	D7R (DOZERS) CAT C9 ACERT		Hydraulic Oil Filter.....	H-55280
Hydraulic Oil Filter.....	H-5526	Cabin Air Filter.....	CA-55140	Hydraulic Oil Filter.....	H-5526
Hydraulic Oil Filter.....	H-5503	Fuel/Water Separator.....	SFC-55180	Hydraulic Oil Filter.....	H-5503
Oil Filter Full Flow.....	C-5510	D7R (DOZERS) S/N: 2EN1-UP		Oil Filter Full Flow.....	C-5510
D7H LGP SERIES II (DOZERS) S/N: 7924000-UP		Air Filter Secondary.....	A-5534	D7R (DOZERS) S/N: 5KZ1-UP	
Air Filter Secondary.....	A-5534	Air Filter Primary.....	A-5535	Air Filter Secondary.....	A-5534
Air Filter Primary.....	A-5535	Air Filter Set.....	A-5573-S	Air Filter Set.....	A-5573-S
Air Filter Primary.....	A-5549M	Fuel Filter.....	F-5505	Air Filter Primary.....	A-5535
Air Filter Set.....	A-5549M-S	Fuel Filter Secondary.....	FC-5507	Fuel Filter.....	F-5505
Air Filter Secondary.....	A-5550	Hydraulic Oil Filter.....	H-55280	Fuel Filter Secondary.....	FC-5507
Air Filter Set.....	A-5573-S	Hydraulic Oil Filter.....	H-5526	Hydraulic Oil Filter.....	H-5503
Fuel Filter Secondary.....	FC-5507	Hydraulic Oil Filter.....	HC-55290	Hydraulic Oil Filter.....	HC-55290
Fuel Filter.....	F-5505	Hydraulic Oil Filter.....	H-5503	Hydraulic Oil Filter.....	H-5526
Hydraulic Oil Filter.....	H-5526	Oil Filter Full Flow.....	C-5510	Hydraulic Oil Filter.....	H-55280
Hydraulic Oil Filter.....	H-55280	D7R (DOZERS) S/N: 2HR1-UP		Oil Filter Full Flow.....	C-5510
Hydraulic Oil Filter.....	H-5506	Air Filter Set.....	A-5573-S	D7R (DOZERS) S/N: 5MR1-UP	
Hydraulic Oil Filter.....	H-5503	Air Filter Primary.....	A-5535	Air Filter Primary.....	A-5535
Oil Filter Full Flow.....	C-5510	Air Filter Secondary.....	A-5534	Air Filter Set.....	A-5573-S
D7H LGP SERIES II (DOZERS) S/N: 80Z4000-UP		Fuel Filter Secondary.....	FC-5507	Air Filter Secondary.....	A-5534
Air Filter Primary.....	A-5549M	Fuel Filter.....	F-5505	Fuel Filter Secondary.....	FC-5507
Air Filter Primary.....	A-5549	Hydraulic Oil Filter.....	H-5526	Fuel Filter.....	F-5505
Air Filter Primary.....	A-5535	Hydraulic Oil Filter.....	H-55280	Hydraulic Oil Filter.....	H-55280
Air Filter Secondary.....	A-5534	Hydraulic Oil Filter.....	H-5526	Hydraulic Oil Filter.....	H-5503
Air Filter Set.....	A-5573-S	Hydraulic Oil Filter.....	H-5503	Oil Filter Full Flow.....	C-5510
Air Filter Secondary.....	A-5550	Oil Filter Full Flow.....	C-5510	D7R (DOZERS) S/N: 9HM1-UP	
Air Filter Set.....	A-5549M-S	D7R (DOZERS) S/N: 2HR1-UP		Air Filter Secondary.....	A-5534
Fuel Filter.....	F-5505	Air Filter Set.....	A-5573-S	Air Filter Set.....	A-5573-S
		Air Filter Primary.....	A-5535		
		Air Filter Secondary.....	A-5534		
		Fuel Filter Secondary.....	FC-5507		
		Fuel Filter.....	F-5505		
		Hydraulic Oil Filter.....	H-5526		
		Hydraulic Oil Filter.....	H-55280		
		Hydraulic Oil Filter.....	H-5503		

MODEL/APPLICATION	SAKURA NO	MODEL/APPLICATION	SAKURA NO	MODEL/APPLICATION	SAKURA NO
CATERPILLAR		CATERPILLAR		CATERPILLAR	
D7R (DOZERS) S/N: 9HM1-UP		Hydraulic Oil Filter.....	H-5526	Hydraulic Oil Filter.....	H-5503
Air Filter Primary.....	A-5535	D7R II (DOZERS) S/N: ABJ1500-UP		Hydraulic Oil Filter.....	H-5526
Fuel Filter.....	F-5505	Air Filter Set.....	A-5573-S	D7R II (DOZERS) S/N: AGN1500-UP	
Fuel Filter Secondary.....	FC-5507	Air Filter Primary.....	A-5535	Air Filter Secondary.....	A-5534
Hydraulic Oil Filter.....	H-5503	Air Filter Secondary.....	A-5534	Air Filter Primary.....	A-5535
Hydraulic Oil Filter.....	H-5526	Hydraulic Oil Filter.....	H-5510	Air Filter Set.....	A-5573-S
Hydraulic Oil Filter.....	H-55280	D7R II (DOZERS) S/N: ACS1-UP		Hydraulic Oil Filter.....	H-5510
Oil Filter Full Flow.....	C-5510	Air Filter Set.....	A-5573-S	D7R LGP (DOZERS) CAT 3176C (S/N: 3DN1-UP)	
D7R (DOZERS) S/N: ACS1-UP		Air Filter Secondary.....	A-5534	Air Filter Secondary.....	A-5534
Air Filter Primary.....	A-5535	Air Filter Primary.....	A-5535	Air Filter Primary.....	A-5535
Air Filter Set.....	A-5573-S	Hydraulic Oil Filter.....	H-5526	Air Filter Set.....	A-5573-S
Air Filter Secondary.....	A-5534	Hydraulic Oil Filter.....	H-5503	Fuel Filter Secondary.....	FC-5507
Hydraulic Oil Filter.....	H-5503	Hydraulic Oil Filter.....	HC-55290	Fuel Filter.....	F-5505
Hydraulic Oil Filter.....	HC-55290	Hydraulic Oil Filter.....	H-55280	Hydraulic Oil Filter.....	H-5526
Hydraulic Oil Filter.....	H-55280	D7R II (DOZERS) S/N: ADW1-UP		Hydraulic Oil Filter.....	H-5503
Hydraulic Oil Filter.....	H-5526	Air Filter Set.....	A-5573-S	Hydraulic Oil Filter.....	H-55280
D7R (DOZERS) S/N: ADW1-UP		Air Filter Primary.....	A-5535	Oil Filter Full Flow.....	C-5510
Air Filter Secondary.....	A-5534	Air Filter Secondary.....	A-5534	D7R LGP (DOZERS) CAT C9 ACERT	
Air Filter Set.....	A-5573-S	Hydraulic Oil Filter.....	H-55280	Cabin Air Filter.....	CA-55140
Air Filter Primary.....	A-5535	Hydraulic Oil Filter.....	HC-55290	D7RXL (DOZERS) CAT 3306	
Fuel/Water Separator Secondary..	SFC-5504-10B	Hydraulic Oil Filter.....	H-5503	Air Filter Secondary.....	A-5534
Fuel/Water Separator Secondary..	SFC-5504-10	Hydraulic Oil Filter.....	H-5526	Air Filter Primary.....	A-5535
Hydraulic Oil Filter.....	H-5503	D7R II (DOZERS) S/N: AEC1-1499		Air Filter Primary.....	A-5549M
Hydraulic Oil Filter.....	H-5526	Air Filter Set.....	A-5573-S	Air Filter Primary.....	A-5549
Hydraulic Oil Filter.....	H-55280	Air Filter Secondary.....	A-5534	Air Filter Secondary.....	A-5550
Hydraulic Oil Filter.....	HC-55290	Air Filter Primary.....	A-5535	Air Filter Set.....	A-5549M-S
D7R (DOZERS) S/N: AFG1-UP		Hydraulic Oil Filter.....	HC-55290	Air Filter Set.....	A-5573-S
Air Filter Primary.....	A-5535	Hydraulic Oil Filter.....	H-55280	Fuel Filter Secondary.....	FC-5507
Air Filter Set.....	A-5573-S	Hydraulic Oil Filter.....	H-5526	Hydraulic Oil Filter.....	H-5503
Air Filter Secondary.....	A-5534	Hydraulic Oil Filter.....	H-5503	Oil Filter Full Flow.....	C-5510
Hydraulic Oil Filter.....	H-55280	D7R II (DOZERS) S/N: AEC1500-UP		D7RL (DOZERS) w/3306 Eng.	
Hydraulic Oil Filter.....	H-5526	Air Filter Set.....	A-5573-S	Air Filter Primary.....	A-5535M
Hydraulic Oil Filter.....	H-5503	Air Filter Secondary.....	A-5534	Air Filter Set.....	A-5573M-S
Hydraulic Oil Filter.....	HC-55290	Air Filter Primary.....	A-5535	D7R II LGP (DOZERS) CAT 3176C	
D7R (DOZERS) W/3176C ENG.		Hydraulic Oil Filter.....	H-55280	Cabin Air Filter.....	CA-55140
Air Filter Primary.....	A-5535M	Hydraulic Oil Filter.....	H-5510	D7R II XR (DOZERS) CAT 3176C	
Air Filter Set.....	A-5573M-S	Hydraulic Oil Filter.....	H-5526	Cabin Air Filter.....	CA-55140
D7R (DOZERS) w/3306 Eng.		D7R II (DOZERS) S/N: AFG1-UP		D7R XR (DOZERS) CAT C9 ACERT	
Air Filter Set.....	A-5573M-S	Air Filter Secondary.....	A-5534	Cabin Air Filter.....	CA-55140
Air Filter Primary.....	A-5535M	Air Filter Primary.....	A-5535	D8 (DOZERS) S/N: 13A-13A	
D7R II (DOZERS) CAT 3176C		Air Filter Set.....	A-5573-S	Oil Filter Full Flow.....	0-5501
Cabin Air Filter.....	CA-55140	Hydraulic Oil Filter.....	H-5526	D8 (DOZERS) S/N: 36A4469-4648	
D7R II (DOZERS) S/N: ABJ1-1499		Hydraulic Oil Filter.....	H-5503	Fuel Filter.....	F-5501
Air Filter Set.....	A-5573-S	Hydraulic Oil Filter.....	HC-55290	Hydraulic Oil Filter.....	H-5503
Air Filter Secondary.....	A-5534	Hydraulic Oil Filter.....	H-55280	Oil Filter Full Flow.....	0-5502
Air Filter Primary.....	A-5535	D7R II (DOZERS) S/N: AGN1-1499		Oil Filter Full Flow.....	0-5505
Hydraulic Oil Filter.....	H-55280	Air Filter Set.....	A-5573-S	D8 (DOZERS) S/N: 36A4469-4648	
Hydraulic Oil Filter.....	HC-55290	Air Filter Primary.....	A-5535	Fuel Filter.....	F-5501
Hydraulic Oil Filter.....	H-5503	Air Filter Secondary.....	A-5534	Hydraulic Oil Filter.....	H-5503
D7R II (DOZERS) S/N: ABJ1-1499		Hydraulic Oil Filter.....	H-55280	Oil Filter Full Flow.....	0-5502
Air Filter Set.....	A-5573-S	D7R II (DOZERS) S/N: AGN1-1499		Oil Filter Full Flow.....	0-5505
Air Filter Secondary.....	A-5534	Air Filter Set.....	A-5573-S		
Air Filter Primary.....	A-5535	Air Filter Primary.....	A-5535		
Hydraulic Oil Filter.....	H-55280	Air Filter Secondary.....	A-5534		
Hydraulic Oil Filter.....	HC-55290	Hydraulic Oil Filter.....	H-55280		
Hydraulic Oil Filter.....	H-5503	Hydraulic Oil Filter.....	HC-55290		

Sakura Filter

ENGINE APPLICATION

MODEL/APPLICATION	SAKURA NO	MODEL/APPLICATION	SAKURA NO	MODEL/APPLICATION	SAKURA NO
CATERPILLAR		CATERPILLAR		CATERPILLAR	
D8 (DOZERS) S/N: 8R1-UP Oil Filter Full Flow..... 0-5505		D8L (DOZERS) CAT 3408 (S/N: 53Y1-UP) Air Filter Primary..... A-5521 Air Filter Set..... A-5521-S Air Filter..... A-5547 Air Filter Secondary..... A-5552 Air Filter Secondary..... A-5560 Air Filter Primary..... A-5561 Air Filter Set..... A-5562-S Coolant Filter..... WC-5707 Fuel Filter..... FC-5509 Fuel Filter..... F-5501 Fuel Filter..... FC-5519 Hydraulic Oil Filter..... H-5503 Hydraulic Oil Filter..... H-5504 Oil Filter Full Flow..... 0-5502 Oil Filter Full Flow..... C-5516		D8L (DOZERS) S/N: 46A10725-12884 Fuel Filter..... F-5501 Hydraulic Oil Filter..... H-5503 Oil Filter Full Flow..... 0-5502	
D8D (DOZERS) Fuel Filter..... F-5501 Hydraulic Oil Filter..... H-5503 Hydraulic Oil Filter..... H-5504 Oil Filter Full Flow..... 0-5505 Oil Filter Full Flow..... 0-5502		D8L (DOZERS) S/N: 46A1-10724 Air Filter Primary..... A-5521 Air Filter Set..... A-5521-S		D8L (DOZERS) S/N: 46A12885-25737 Air Filter Primary..... A-5515 Air Filter Secondary..... A-5528 Air Filter Set..... A-5515-S Fuel Filter..... F-5501 Hydraulic Oil Filter..... H-5503 Oil Filter Full Flow..... 0-5502	
D8E (DOZERS) Fuel Filter..... F-5501 Hydraulic Oil Filter..... H-5504 Oil Filter Full Flow..... 0-5502 Oil Filter Full Flow..... 0-5505		D8L (DOZERS) S/N: 22A1-UP Fuel Filter..... F-5501 Hydraulic Oil Filter..... H-5504 Oil Filter Full Flow..... 0-5502		D8L (DOZERS) S/N: 46A25738-25740 Air Filter Set..... A-5573-S Air Filter Primary..... A-5535 Air Filter Secondary..... A-5502 Air Filter Secondary..... A-5534 Air Filter Primary..... A-5501 Fuel Filter..... F-5501 Hydraulic Oil Filter..... H-5503 Oil Filter Full Flow..... 0-5502	
D8G (DOZERS) Fuel Filter..... F-5501 Hydraulic Oil Filter..... H-5504 Hydraulic Oil Filter..... H-5503 Oil Filter Full Flow..... 0-5505 Oil Filter Full Flow..... 0-5502		D8L (DOZERS) S/N: 35A1-UP Fuel Filter..... F-5501 Hydraulic Oil Filter..... H-5504 Oil Filter Full Flow..... 0-5502		D8L (DOZERS) S/N: 46A25741-25742 Air Filter Set..... A-5521-S Air Filter Primary..... A-5521	
D8H (DOZERS) S/N: 35A1-UP Fuel Filter..... F-5501 Hydraulic Oil Filter..... H-5504 Oil Filter Full Flow..... 0-5502		D8L (DOZERS) S/N: 36A1-4468 Air Filter Set..... A-5521-S Air Filter Primary..... A-5521		D8L (DOZERS) S/N: 46A25743-25743 Air Filter Primary..... A-5521 Air Filter Set..... A-5521-S	
D8H (DOZERS) S/N: 68A1-UP Fuel Filter..... F-5501 Hydraulic Oil Filter..... H-5504 Oil Filter Full Flow..... 0-5502		D8L (DOZERS) S/N: 36A4649-5383 Fuel Filter..... F-5501 Hydraulic Oil Filter..... H-5503 Oil Filter Full Flow..... 0-5502		D8L (DOZERS) S/N: 46A25744-25745 Air Filter Set..... A-5521-S Air Filter Primary..... A-5521	
D8K (DOZERS) S/N: 66V1-UP Fuel Filter Secondary..... FC-5507 Hydraulic Oil Filter..... H-5503 Oil Filter Full Flow..... C-5516		D8L (DOZERS) S/N: 36A5384-5524 Air Filter Primary..... A-5501 Air Filter Secondary..... A-5502 Air Filter Secondary..... A-5534 Air Filter Set..... A-5573-S Air Filter Primary..... A-5535 Fuel Filter..... F-5501 Hydraulic Oil Filter..... H-5503 Oil Filter Full Flow..... 0-5502		D8L (DOZERS) S/N: 46A25746-28136 Air Filter Secondary..... A-5534 Air Filter Secondary..... A-5502 Air Filter Primary..... A-5535 Air Filter Set..... A-5573-S Air Filter Primary..... A-5501 Fuel Filter..... F-5501 Hydraulic Oil Filter..... H-5503 Oil Filter Full Flow..... 0-5502	
D8K (DOZERS) S/N: 76V1-UP Air Filter Set..... A-5573-S Air Filter Secondary..... A-5502 Air Filter Primary..... A-5501 Air Filter Primary..... A-5535 Air Filter Secondary..... A-5534 Fuel Filter Secondary..... FC-5507 Hydraulic Oil Filter..... H-5503 Oil Filter Full Flow..... C-5516		D8L (DOZERS) S/N: 36A5525-UP Air Filter Primary..... A-5535 Air Filter Set..... A-5573-S Air Filter Secondary..... A-5534 Air Filter Secondary..... A-5502 Air Filter Primary..... A-5501 Fuel Filter Secondary..... FC-5507 Hydraulic Oil Filter..... H-5503 Oil Filter Full Flow..... C-5516		D8L (DOZERS) S/N: 46A28137-29449 Air Filter Primary..... A-5501 Air Filter Set..... A-5573-S Air Filter Primary..... A-5535 Air Filter Secondary..... A-5502 Air Filter Secondary..... A-5534 Fuel Filter Secondary..... FC-5507	

Sakura Filter

ENGINE APPLICATION

MODEL/APPLICATION	SAKURA NO	MODEL/APPLICATION	SAKURA NO	MODEL/APPLICATION	SAKURA NO
CATERPILLAR		CATERPILLAR		CATERPILLAR	
D8L (DOZERS) S/N: 46A28137-29449 Hydraulic Oil Filter..... H-5503 Oil Filter Full Flow..... 0-5502		Air Filter Secondary..... A-5534 Air Filter Secondary..... A-5502 Air Filter Set..... A-5573-S Air Filter Primary..... A-5535 Air Filter Primary..... A-5501 Fuel Filter Secondary..... FC-5507 Hydraulic Oil Filter..... H-5503 Oil Filter Full Flow..... C-5516		Hydraulic Oil Filter..... H-55280 Oil Filter Full Flow..... C-5516	
D8L (DOZERS) S/N: 46A29450-UP Air Filter Secondary..... A-5534 Air Filter Secondary..... A-5502 Air Filter Primary..... A-5535 Air Filter Set..... A-5573-S Air Filter Primary..... A-5501 Fuel Filter Secondary..... FC-5507 Hydraulic Oil Filter..... H-5503 Oil Filter Full Flow..... C-5516		D8L (DOZERS) S/N: 73C1-UP Air Filter Secondary..... A-5552 Air Filter Primary..... A-5521 Air Filter Set..... A-5521-S Fuel Filter..... FC-5509 Fuel Filter..... F-5505 Hydraulic Oil Filter..... H-5504 Hydraulic Oil Filter..... H-55270 Hydraulic Oil Filter..... H-5509 Oil Filter Full Flow..... C-5516		D8N (DOZERS) S/N: 5TJ00754-00751 Air Filter Set..... A-5573-S Air Filter Primary..... A-5535 Air Filter Secondary..... A-5534 Fuel Filter..... FC-5519 Hydraulic Oil Filter..... H-55270 Oil Filter Full Flow..... C-5516	
D8L (DOZERS) S/N: 4FB1-UP Air Filter Secondary..... A-5552 Air Filter Primary..... A-5521 Air Filter Set..... A-5521-S Fuel Filter..... F-5505 Fuel Filter..... FC-5509 Hydraulic Oil Filter..... H-55270 Hydraulic Oil Filter..... H-5509 Hydraulic Oil Filter..... H-5504 Oil Filter Full Flow..... C-5516		D8L (DOZERS) S/N: 7YB1-1572 Air Filter Set..... A-5521-S Air Filter Primary..... A-5521 Air Filter Secondary..... A-5552 Fuel Filter..... F-5505 Oil Filter Full Flow..... C-5516		D8N (DOZERS) S/N: 5TJ1-UP Air Filter Secondary..... A-5534 Air Filter Set..... A-5573-S Air Filter Primary..... A-5535 Air Filter Primary..... A-5501 Air Filter Secondary..... A-5502 Fuel Filter..... F-5505 Fuel Filter..... FC-5509 Hydraulic Oil Filter..... H-5510 Hydraulic Oil Filter..... H-55270 Oil Filter Full Flow..... C-5516	
D8L (DOZERS) S/N: 52A1-UP Fuel Filter..... F-5501 Hydraulic Oil Filter..... H-5504 Oil Filter Full Flow..... 0-5502		D8L (DOZERS) S/N: 7YB1573-UP Air Filter Secondary..... A-5552 Air Filter Primary..... A-5521 Air Filter Set..... A-5521-S Fuel Filter..... F-5505 Hydraulic Oil Filter..... H-55270		D8N (DOZERS) S/N: 7TK1-UP Air Filter Set..... A-5573-S Air Filter Primary..... A-5535 Air Filter Secondary..... A-5534 Fuel Filter..... F-5505 Hydraulic Oil Filter..... H-55270 Hydraulic Oil Filter..... H-5510 Oil Filter Full Flow..... C-5516	
D8L (DOZERS) S/N: 53Y1-UP Air Filter Set..... A-5521-S Air Filter Primary..... A-5521 Air Filter Secondary..... A-5552 Fuel Filter..... F-5505 Fuel Filter..... FC-5509 Hydraulic Oil Filter..... H-5509 Hydraulic Oil Filter..... H-5504 Hydraulic Oil Filter..... H-55270 Oil Filter Full Flow..... C-5516		D8L (DOZERS) S/N: 7YB1-UP Air Filter Set..... A-5521-S Air Filter Primary..... A-5521 Air Filter Secondary..... A-5552 Air Filter Secondary..... A-5560 Air Filter Set..... A-5562-S Air Filter Primary..... A-5561 Fuel Filter..... F-5505 Hydraulic Oil Filter..... H-5504 Oil Filter Full Flow..... C-5516		D8N (DOZERS) S/N: 9TC1-2453 Air Filter Primary..... A-5535 Air Filter Secondary..... A-5502 Air Filter Primary..... A-5501 Air Filter Set..... A-5573-S Air Filter Secondary..... A-5534 Hydraulic Oil Filter..... H-5526 Hydraulic Oil Filter..... H-55280 Hydraulic Oil Filter..... H-5503	
D8L (DOZERS) S/N: 68A1-UP Fuel Filter..... F-5501 Hydraulic Oil Filter..... H-5504 Oil Filter Full Flow..... 0-5502		D8N (DOZERS) CAT 3406 Cabin Air Filter..... CA-55140		D8N (DOZERS) S/N: 9TC1-UP Air Filter Set..... A-5573-S Air Filter Primary..... A-5501 Air Filter Secondary..... A-5502 Air Filter Primary..... A-5535 Air Filter Secondary..... A-5534 Fuel Filter..... F-5505 Hydraulic Oil Filter..... H-5503 Hydraulic Oil Filter..... H-55280 Hydraulic Oil Filter..... H-5526 Oil Filter Full Flow..... C-5516	
D8L (DOZERS) S/N: 76V1-UP Air Filter Primary..... A-5501 Air Filter Primary..... A-5535 Air Filter Set..... A-5573-S Air Filter Secondary..... A-5502 Air Filter Secondary..... A-5534 Fuel Filter Secondary..... FC-5507 Hydraulic Oil Filter..... H-5503 Oil Filter Full Flow..... C-5516		D8L (DOZERS) S/N: 1XJ1-UP Air Filter Set..... A-5573-S Air Filter Secondary..... A-5502 Air Filter Primary..... A-5501 Air Filter Primary..... A-5535 Air Filter Secondary..... A-5534 Fuel Filter..... F-5505 Fuel Filter..... FC-5509 Hydraulic Oil Filter..... H-5526 Hydraulic Oil Filter..... H-5503		D8N (DOZERS) S/N: 9TC2454-UP Air Filter Secondary..... A-5534 Air Filter Primary..... A-5535 Air Filter Secondary..... A-5502 Air Filter Primary..... A-5501	
D8L (DOZERS) S/N: 77V1-UP					

MODEL/APPLICATION	SAKURA NO
CATERPILLAR	
D8N (DOZERS) S/N: 9TC2454-UP	
Air Filter Set.....	A-5573-S
Hydraulic Oil Filter.....	H-5526
Hydraulic Oil Filter.....	H-55280
Hydraulic Oil Filter.....	H-5503
D8N (DOZERS) w/3406 Eng.	
Air Filter Primary.....	A-5535M
Air Filter Set.....	A-5573M-S
D8R (DOZERS) CAT 3406C	
Cabin Air Filter.....	CA-55140
D8R (DOZERS) CAT 3406C TA (S/N: 7XM1-UP)	
Air Filter Primary.....	A-5555
Air Filter Set.....	A-5555-S
Air Filter Secondary.....	A-5556
Fuel Filter.....	F-5505
Fuel Filter.....	FC-5509
Hydraulic Oil Filter.....	H-5526
Hydraulic Oil Filter.....	H-55270
Hydraulic Oil Filter.....	H-55280
Oil Filter Full Flow.....	C-5516
D8R (DOZERS) CAT 3406C TA (S/N: 9EM1-UP)	
Air Filter Secondary.....	A-5556
Air Filter Set.....	A-5555-S
Air Filter Primary.....	A-5555
Fuel Filter.....	FC-5509
Fuel Filter.....	F-5505
Hydraulic Oil Filter.....	H-55280
Hydraulic Oil Filter.....	H-55270
Hydraulic Oil Filter.....	H-5510
Oil Filter Full Flow.....	C-5516
D8R (DOZERS) CAT 3406C TA (S/N: AK1-UP)	
Air Filter Primary.....	A-5555
Air Filter Set.....	A-5555-S
Air Filter Secondary.....	A-5556
Fuel Filter.....	FC-5509
Hydraulic Oil Filter.....	H-5510
Hydraulic Oil Filter.....	H-5503
Hydraulic Oil Filter.....	H-5526
Oil Filter Full Flow.....	C-5516
D8R (DOZERS)	
Air Filter Secondary.....	A-5556
Air Filter Set.....	A-5555-S
Air Filter Primary.....	A-5555
Fuel Filter.....	FC-5509
Hydraulic Oil Filter.....	H-5503
Hydraulic Oil Filter.....	H-5526
Oil Filter Full Flow.....	C-5516
D8R II (DOZERS) CAT 3406E	
Cabin Air Filter.....	CA-55140

MODEL/APPLICATION	SAKURA NO
CATERPILLAR	
D8R SERIES II (DOZERS) CAT 3406E TA	
Air Filter Primary.....	A-5555
Air Filter Set.....	A-5555-S
Air Filter Secondary.....	A-5556
Fuel Filter.....	FC-5509
Hydraulic Oil Filter.....	H-55280
Hydraulic Oil Filter.....	H-5503
Oil Filter Full Flow.....	C-5516
D8R SERIES II (DOZERS) S/N: 6YZ1-UP	
Air Filter Secondary.....	A-5556
Air Filter Set.....	A-5555-S
Air Filter Primary.....	A-5555
Hydraulic Oil Filter.....	H-5510
Hydraulic Oil Filter.....	H-55270
Hydraulic Oil Filter.....	H-5526
Hydraulic Oil Filter.....	H-5503
Hydraulic Oil Filter.....	H-55280
D8R SERIES II (DOZERS) S/N: AK1-UP	
Air Filter Set.....	A-5555-S
Air Filter Secondary.....	A-5556
Air Filter Primary.....	A-5555
Hydraulic Oil Filter.....	H-5526
Hydraulic Oil Filter.....	H-5510
Hydraulic Oil Filter.....	H-55280
Hydraulic Oil Filter.....	H-5503
D8T (DOZERS) CAT (S/N: LHX1-UP)	
Fuel Filter.....	FC-5517
D8T (DOZERS) S/N: J8B1-UP	
Air Filter Secondary.....	A-5556
Air Filter Set.....	A-5555-S
Air Filter Primary.....	A-5555
Hydraulic Oil Filter.....	H-5503
Hydraulic Oil Filter.....	H-5510
Hydraulic Oil Filter.....	H-5526
Hydraulic Oil Filter.....	H-55280
Hydraulic Oil Filter.....	HC-55170
D8T (DOZERS) S/N: KPZ1-UP	
Air Filter Primary.....	A-5555
Air Filter Set.....	A-5555-S
Air Filter Secondary.....	A-5556
Hydraulic Oil Filter.....	H-5503
Hydraulic Oil Filter.....	HC-55170
Hydraulic Oil Filter.....	HC-5504
Hydraulic Oil Filter.....	H-55280
Hydraulic Oil Filter.....	H-5526
Hydraulic Oil Filter.....	H-5510
D9 (DOZERS) S/N: 66A11908-UP	
Air Filter Secondary.....	A-5529
Air Filter Set.....	A-5521-S
Air Filter Primary.....	A-5521
Fuel Filter.....	F-5501
Hydraulic Oil Filter.....	H-5503
Hydraulic Oil Filter.....	H-5506
Oil Filter Full Flow.....	C-5516
D9 (DOZERS) S/N: 90V1-UP	
Air Filter Set.....	A-5555-S
Air Filter Primary.....	A-5555
Air Filter Secondary.....	A-5556
Air Filter Primary.....	A-5521
Air Filter Set.....	A-5521-S
Air Filter Secondary.....	A-5529
Fuel Filter.....	F-5505
Hydraulic Oil Filter.....	H-5503
Hydraulic Oil Filter.....	H-5506
Oil Filter Full Flow.....	C-5516
D9D (DOZERS)	
Fuel Filter.....	F-5501
Oil Filter Full Flow.....	O-5503
Oil Filter Full Flow.....	O-5505
D9E (DOZERS) S/N: 34A1-UP	
Air Filter Secondary.....	A-5526
Fuel Filter.....	F-5501
Hydraulic Oil Filter.....	H-5504
Oil Filter Full Flow.....	O-5505
Oil Filter Full Flow.....	O-5503
D9G (DOZERS) S/N: 66A12016-UP	
Air Filter Secondary.....	A-5529
Air Filter Primary.....	A-5521
Air Filter Set.....	A-5521-S
Hydraulic Oil Filter.....	H-5503
Oil Filter Full Flow.....	O-5503
D9G (DOZERS) S/N: 66A1-3074	
Fuel Filter.....	F-5501
Hydraulic Oil Filter.....	H-5504
Oil Filter Full Flow.....	O-5503
D9G (DOZERS) S/N: 66A3075-3265	
Air Filter Set.....	A-5557-S

MODEL/APPLICATION	SAKURA NO
CATERPILLAR	
Air Filter Set.....	A-5555-S
Air Filter Primary.....	A-5555
Hydraulic Oil Filter.....	H-5503
Oil Filter Full Flow.....	O-5503
D9 (DOZERS) S/N: 66A9418-9949	
Air Filter Primary.....	A-5557
Air Filter Set.....	A-5557-S
Air Filter Secondary.....	A-5526
Fuel Filter.....	F-5501
Hydraulic Oil Filter.....	H-5503
Oil Filter Full Flow.....	O-5503
D9 (DOZERS) S/N: 66A9950-11907	
Air Filter Secondary.....	A-5526
Air Filter Set.....	A-5557-S
Air Filter Primary.....	A-5557
Hydraulic Oil Filter.....	H-5503
Oil Filter Full Flow.....	O-5503
D9 (DOZERS) S/N: 90V1-UP	
Air Filter Set.....	A-5555-S
Air Filter Primary.....	A-5555
Air Filter Secondary.....	A-5556
Air Filter Primary.....	A-5521
Air Filter Set.....	A-5521-S
Air Filter Secondary.....	A-5529
Fuel Filter.....	F-5505
Hydraulic Oil Filter.....	H-5503
Hydraulic Oil Filter.....	H-5506
Oil Filter Full Flow.....	C-5516
D9D (DOZERS)	
Fuel Filter.....	F-5501
Oil Filter Full Flow.....	O-5503
Oil Filter Full Flow.....	O-5505
D9E (DOZERS) S/N: 34A1-UP	
Air Filter Secondary.....	A-5526
Fuel Filter.....	F-5501
Hydraulic Oil Filter.....	H-5504
Oil Filter Full Flow.....	O-5505
Oil Filter Full Flow.....	O-5503
D9G (DOZERS) S/N: 66A12016-UP	
Air Filter Secondary.....	A-5529
Air Filter Primary.....	A-5521
Air Filter Set.....	A-5521-S
Hydraulic Oil Filter.....	H-5503
Oil Filter Full Flow.....	O-5503
D9G (DOZERS) S/N: 66A1-3074	
Fuel Filter.....	F-5501
Hydraulic Oil Filter.....	H-5504
Oil Filter Full Flow.....	O-5503
D9G (DOZERS) S/N: 66A3075-3265	
Air Filter Set.....	A-5557-S

MODEL/APPLICATION	SAKURA NO
CATERPILLAR	
D9G (DOZERS) S/N: 66A3075-3265	
Air Filter Primary.....	A-5557
Air Filter Secondary.....	A-5526
Fuel Filter.....	F-5501
Hydraulic Oil Filter.....	H-5504
Oil Filter Full Flow.....	O-5503
D9G (DOZERS) S/N: 66A3266-4173	
Air Filter Secondary.....	A-5526
Air Filter Primary.....	A-5557
Air Filter Set.....	A-5557-S
Fuel Filter.....	F-5501
Hydraulic Oil Filter.....	H-5503
Oil Filter Full Flow.....	O-5503
D9G (DOZERS) S/N: 66A4174-9417	
Air Filter Set.....	A-5557-S
Air Filter Primary.....	A-5557
Air Filter Secondary.....	A-5526
Fuel Filter.....	F-5501
Hydraulic Oil Filter.....	H-5503
Oil Filter Full Flow.....	O-5503
D9G (DOZERS) S/N: 66A9418-12015	
Air Filter Set.....	A-5521-S
Air Filter Primary.....	A-5521
Air Filter Secondary.....	A-5529
Fuel Filter Secondary.....	FC-5507
Oil Filter Full Flow.....	O-5503
D9G (DOZERS) S/N: 90J1-UP	
Air Filter Set.....	A-5557-S
Air Filter Primary.....	A-5557
Fuel Filter.....	F-5505
Hydraulic Oil Filter.....	H-5503
Oil Filter Full Flow.....	O-5503
D9G (DOZERS) S/N: 91J1-UP	
Air Filter Set.....	A-5557-S
Air Filter Primary.....	A-5557
Fuel Filter.....	F-5505
Hydraulic Oil Filter.....	H-5503
Oil Filter Full Flow.....	O-5503
D9H (DOZERS) S/N: 12U1-UP	
Air Filter Set.....	A-5521-S
Air Filter Primary.....	A-5521
Air Filter Secondary.....	A-5529
Hydraulic Oil Filter.....	H-5503
Oil Filter Full Flow.....	O-5505
D9H (DOZERS) S/N: 97V1-UP	
Air Filter Set.....	A-5521-S
Air Filter Secondary.....	A-5529
Air Filter Primary.....	A-5521
Hydraulic Oil Filter.....	H-5503

MODEL/APPLICATION	SAKURA NO
CATERPILLAR	
Oil Filter Full Flow.....	O-5505
D9H (DOZERS) S/N: 98V1-UP	
Air Filter Primary.....	A-5521
Air Filter Secondary.....	A-5529
Air Filter Set.....	A-5521-S
Hydraulic Oil Filter.....	H-5503
Oil Filter Full Flow.....	O-5505
D9H (DOZERS) S/N: 99V1-UP	
Air Filter Set.....	A-5521-S
Air Filter Secondary.....	A-5529
Air Filter Primary.....	A-5521
Hydraulic Oil Filter.....	H-5503
Oil Filter Full Flow.....	O-5505
D9L (DOZERS) CAT 3412 (S/N: 14Y1-UP)	
Air Filter Secondary.....	A-55291
Air Filter Primary.....	A-5532
Air Filter Set.....	A-5532-S
Air Filter.....	A-5547
Air Filter Set.....	A-5565-S
Air Filter Primary.....	A-5564
Air Filter Secondary.....	A-5563
Coolant Filter.....	WC-5707
Fuel Filter.....	FC-5509
Hydraulic Oil Filter.....	H-5504
Oil Filter Full Flow.....	C-5516
D9N (DOZERS) S/N: 1J01-UP	
Air Filter Primary.....	A-5521
Air Filter Set.....	A-5521-S
Air Filter Secondary.....	A-5552
Fuel Filter.....	F-5505
Hydraulic Oil Filter.....	H-5504
Hydraulic Oil Filter.....	H-55270
Oil Filter Full Flow.....	C-5516
D9N (DOZERS) S/N: 1J02656N-1J02656N	
Air Filter Secondary.....	A-5560
Air Filter Primary.....	A-5561
Air Filter Set.....	A-5562-S
D9N (DOZERS) S/N: 6XJ1-UP	
Air Filter Secondary.....	A-5560
Air Filter Set.....	A-5562-S
Air Filter Primary.....	A-5561
Fuel Filter.....	F-5505
Fuel Filter.....	FC-5509
Oil Filter Full Flow.....	C-5516
D9N (DOZERS) S/N: 6YF1-540	
Air Filter Secondary.....	A-5560
Air Filter Primary.....	A-5561
Air Filter Set.....	A-5562-S
Fuel Filter.....	FC-5509
Hydraulic Oil Filter.....	H-5504
Oil Filter Full Flow.....	C-5516

MODEL/APPLICATION	SAKURA NO
CATERPILLAR	
D9R (DOZERS) CAT 3408C (S/N: 7TL1-556)	
Air Filter Primary.....	A-5561
Air Filter Set.....	A-5562-S
Air Filter Secondary.....	A-5560
Fuel Filter.....	F-5505
Fuel Filter.....	FC-5509
Hydraulic Oil Filter.....	H-55270
Hydraulic Oil Filter.....	H-5510
Hydraulic Oil Filter.....	H-5504
Hydraulic Oil Filter.....	H-5506
Oil Filter Full Flow.....	C-5516
D9R (DOZERS) CAT 3408C (S/N: 7TL1-UP)	
Air Filter Secondary.....	A-5560
Air Filter Set.....	A-5562-S
Air Filter Primary.....	A-5561
Fuel Filter.....	FC-5509
Hydraulic Oil Filter.....	H-5504
Hydraulic Oil Filter.....	H-5510
Oil Filter Full Flow.....	C-5516
D9R (DOZERS) CAT 3408C (S/N: 7TL557-851)	
Air Filter Secondary.....	A-5560
Air Filter Primary.....	A-5561
Air Filter Set.....	A-5562-S
Fuel Filter.....	F-5505
Fuel Filter.....	FC-5509
Hydraulic Oil Filter.....	H-55270
Hydraulic Oil Filter.....	H-5510
Hydraulic Oil Filter.....	H-5504
Hydraulic Oil Filter.....	H-5506
Oil Filter Full Flow.....	C-5516
D9R (DOZERS) CAT 3408C (S/N: 7TL852-UP)	
Air Filter Secondary.....	A-5560
Air Filter Set.....	A-5562-S
Air Filter Primary.....	A-5561
Fuel Filter.....	FC-5509
Hydraulic Oil Filter.....	H-5504
Hydraulic Oil Filter.....	H-5510
Hydraulic Oil Filter.....	H-55270
Hydraulic Oil Filter.....	H-5506
Oil Filter Full Flow.....	C-5516
D9R (DOZERS) CAT 3408C (S/N: 8BL1053-UP)	
Air Filter Primary.....	A-5561
Air Filter Set.....	A-5562-S
Air Filter Secondary.....	A-5560
Fuel Filter.....	FC-5509
Hydraulic Oil Filter.....	H-55270
Hydraulic Oil Filter.....	H-5510
Hydraulic Oil Filter.....	H-5504
Hydraulic Oil Filter.....	H-5506
Oil Filter Full Flow.....	C-5516
D9R (DOZERS) CAT 3408C (S/N: 8BL1-830)	
Air Filter Secondary.....	A-5560

Sakura Filter

ENGINE APPLICATION

MODEL/APPLICATION	SAKURA NO	MODEL/APPLICATION	SAKURA NO	MODEL/APPLICATION	SAKURA NO
CATERPILLAR		CATERPILLAR		CATERPILLAR	
D9T (DOZERS) CAT S/N: RJS1-689-UP , 2008-UP		DP70 (FORKLIFTS)		Oil Filter Full Flow.....	0-5505
Air Filter Set.....	A-44240-S	Fuel Filter.....	FC-1007	DW-20 (SCRAPERS) S/N: 57C-UP	
Air Filter Primary.....	A-44220	Oil Filter Full Flow.....	C-1032	Fuel Filter.....	F-5501
Air Filter Secondary.....	A-44230	Oil Filter Full Flow.....	C-5811	Oil Filter Full Flow.....	0-5505
Fuel Filter.....	FC-5510	DP70 (FORKLIFTS) w/Mitsubishi S6S Eng.		Oil Filter Full Flow.....	0-5503
Fuel Filter.....	FC-5517	Air Filter Secondary.....	A-5590	DW-20 (SCRAPERS) S/N: 6W1-274	
Fuel Filter.....	FC-5509	DP80 (FORKLIFTS) MITSUBISHI 6D16		Oil Filter Full Flow.....	0-5503
Hydraulic Oil Filter.....	H-5506	Oil Filter Full Flow.....	C-1032	Oil Filter Full Flow.....	0-5505
Hydraulic Oil Filter.....	HC-55170	DPL40 (FORKLIFTS)		DW-20 (SCRAPERS) S/N: 6W275-324	
Oil Filter Full Flow.....	C-7906	Air Filter Secondary.....	A-5525	Oil Filter Full Flow.....	0-5505
D9T (DOZERS) CAT S/N: RJS690-UP , 2008-UP		DW-10 (SCRAPERS)		Oil Filter Full Flow.....	0-5503
Air Filter Secondary.....	A-44230	Air Filter Secondary.....	A-5508	DW-20 (SCRAPERS) S/N: 67C-UP	
Air Filter Primary.....	A-44220	Air Filter Set.....	A-55071-S	Fuel Filter.....	F-5501
Air Filter Set.....	A-44240-S	Air Filter Set.....	A-5507-S	Oil Filter Full Flow.....	0-5503
Fuel Filter.....	FC-5509	Air Filter Primary.....	A-5507	Oil Filter Full Flow.....	0-5505
Fuel Filter.....	FC-5517	Oil Filter Full Flow.....	0-5505	DW-20 (SCRAPERS) S/N: 87E-UP	
Fuel Filter.....	FC-5510	Oil Filter Full Flow.....	0-5501	Fuel Filter.....	F-5501
Hydraulic Oil Filter.....	H-5506	DW-15 (SCRAPERS)		Oil Filter Full Flow.....	0-5505
Oil Filter Full Flow.....	C-7906	Fuel Filter.....	F-5501	Oil Filter Full Flow.....	0-5503
DP100 (FORKLIFTS)		Oil Filter Full Flow.....	0-5501	Oil Filter Full Flow.....	0-5505
Oil Filter Full Flow.....	C-1032	Oil Filter Full Flow.....	0-5503	DW-20 (SCRAPERS) S/N: 88E-UP	
DP20 (FORKLIFTS)		DW-15 (SCRAPERS) S/N: 45C-UP		Fuel Filter.....	F-5501
Air Filter.....	A-1096	Oil Filter Full Flow.....	0-5505	Oil Filter Full Flow.....	0-5503
Oil Filter Full Flow.....	C-5811	Oil Filter Full Flow.....	0-5505	Oil Filter Full Flow.....	0-5505
DP40 (FORKLIFTS)		DW-15 (SCRAPERS) S/N: 59C-UP		DW-21 (SCRAPERS) S/N: 58C-UP	
Fuel Filter.....	FC-1007	Oil Filter Full Flow.....	0-5503	Fuel Filter.....	F-5501
DP45 (FORKLIFTS)		Oil Filter Full Flow.....	0-5505	Oil Filter Full Flow.....	0-5503
Air Filter Secondary.....	A-5525	Oil Filter Full Flow.....	0-5501	DW-21 (SCRAPERS) S/N: 69C-UP	
DP45 (FORKLIFTS) w/Mitsubishi S6E Eng.		DW-15 (SCRAPERS) S/N: 70C1-343		Fuel Filter.....	F-5501
Air Filter Secondary.....	A-5590	Fuel Filter.....	F-5501	Oil Filter Full Flow.....	0-5503
DP45 (FORKLIFTS) w/Mitsubishi S6S Eng.		Oil Filter Full Flow.....	0-5503	Oil Filter Full Flow.....	0-5501
Air Filter Secondary.....	A-5590	Oil Filter Full Flow.....	0-5501	DW-21 (SCRAPERS) S/N: 8W1-1060	
DP45K (FORKLIFTS) w/Mitsubishi S6S Eng.		Oil Filter Full Flow.....	0-5505	Oil Filter Full Flow.....	0-5505
Air Filter Secondary.....	A-5590	DW-15 (SCRAPERS) S/N: 70C1-343		DW-21 (SCRAPERS) S/N: 85E-UP	
DP50 (FORKLIFTS) w/Mitsubishi S6E Eng.		Fuel Filter.....	F-5501	Fuel Filter.....	F-5501
Air Filter Secondary.....	A-5590	Oil Filter Full Flow.....	0-5503	Oil Filter Full Flow.....	0-5503
DP50 (FORKLIFTS) w/Mitsubishi S6S Eng.		Oil Filter Full Flow.....	0-5505	DW-21 (SCRAPERS) S/N: 86E-UP	
Air Filter Secondary.....	A-5590	Oil Filter Full Flow.....	0-5501	Fuel Filter.....	F-5501
DP50K (FORKLIFTS) w/Mitsubishi S6S Eng.		DW-20 (SCRAPERS) S/N: 21C1-822		Oil Filter Full Flow.....	0-5503
Air Filter Secondary.....	A-5590	Oil Filter Full Flow.....	0-5503	Oil Filter Full Flow.....	0-5505
DP60 (FORKLIFTS)		DW-20 (SCRAPERS) S/N: 21C823-UP		E110 (EXCAVATORS) MITSUBISHI 4D31T (S/N: 3FG1-UP)	
Oil Filter Full Flow.....	C-1032	Oil Filter Full Flow.....	0-5505	Hydraulic Oil Filter.....	HC-5801
		Oil Filter Full Flow.....	0-5503	E110B (EXCAVATORS) MITSUBISHI 4D32 DIESEL (S/N: 4FJ1-UP)	
		DW-20 (SCRAPERS) S/N: 50C-UP		Fuel Filter Secondary.....	FC-5507
		Oil Filter Full Flow.....	0-5503		

MODEL/APPLICATION	SAKURA NO	MODEL/APPLICATION	SAKURA NO	MODEL/APPLICATION	SAKURA NO
CATERPILLAR		CATERPILLAR		CATERPILLAR	
E110B (EXCAVATORS) MITSUBISHI 4D32 DIESEL (S/N: 5GK1-UP)		Air Filter Secondary.....	A-5508	Air Filter Set.....	A-6118-S
Fuel Filter Secondary.....	FC-5507	Air Filter Primary.....	A-5507	Air Filter Primary.....	A-5627
E110B (EXCAVATORS) MITSUBISHI 4D32 DIESEL (S/N: 8MF1-UP)		Air Filter Set.....	A-5507-S	Air Filter Set.....	A-5663-S
Fuel Filter Secondary.....	FC-5507	Air Filter Set.....	A-55071-S	Air Filter Secondary.....	A-6007
Oil Filter Full Flow.....	C-5505	Fuel Filter Secondary.....	FC-5507	Fuel Filter.....	F-5505
E110B (EXCAVATORS) MITSUBISHI 4D32 DIESEL (S/N: 9HF1-UP)		Hydraulic Oil Filter.....	HC-5801	Fuel Filter Secondary.....	FC-5515
Fuel Filter Secondary.....	FC-5507	Hydraulic Oil Filter.....	H-5505	Fuel Filter.....	FC-5516
E110B (EXCAVATORS) MITSUBISHI 54K-T (S/N: 8MF1-UP)		Oil Filter Full Flow.....	C-5505	Fuel Filter Secondary.....	FC-55151
Air Filter Primary.....	A-5627	E180 (EXCAVATORS) CAT 3204 (S/N: 4EF1-UP)		Hydraulic Oil Filter.....	H-5505
Air Filter Set.....	A-5663-S	Air Filter Secondary.....	A-5508	Oil Filter Full Flow.....	C-5510
Fuel Filter Secondary.....	FC-5507	Air Filter Set.....	A-55071-S	E200B (EXCAVATORS) S/N: 6KF1-UP	
Fuel Filter.....	FC-5516	Air Filter Set.....	A-5507-S	Air Filter Secondary.....	A-6007
Fuel Filter Secondary.....	FC-5515	Air Filter Primary.....	A-5507	Air Filter Set.....	A-5663-S
Fuel Filter Secondary.....	FC-55151	Fuel Filter Secondary.....	FC-5507	Air Filter Primary.....	A-5627
Fuel Filter.....	F-5505	Hydraulic Oil Filter.....	H-5505	Air Filter Set.....	A-6118-S
Hydraulic Oil Filter.....	HC-5801	Oil Filter Full Flow.....	C-5505	Air Filter Primary.....	A-6006
Oil Filter Full Flow.....	C-5505	E180 (EXCAVATORS) MITSUBISHI 4D32 DIESEL (S/N: 1RF101-UP)		Air Filter Secondary.....	A-6008
E120 (EXCAVATORS) MITSUBISHI 4D32 DIESEL (S/N: 1LF9251-UP)		Air Filter Primary.....	A-5507	Fuel Filter Secondary.....	FC-5507
Fuel Filter.....	FC-1010	Air Filter Set.....	A-5507-S	Hydraulic Oil Filter.....	HC-5801
Hydraulic Oil Filter.....	HC-5801	Air Filter Set.....	A-55071-S	Hydraulic Oil Filter.....	H-5505
Oil Filter Combination.....	O-1006	Air Filter Secondary.....	A-5525	Hydraulic Oil Filter.....	H-5513
E120 (EXCAVATORS) MITSUBISHI 6D14 (S/N: 1LF1-UP)		Fuel Filter.....	FC-5503	Oil Filter Full Flow.....	C-5510
Hydraulic Oil Filter.....	HC-5801	Hydraulic Oil Filter.....	HC-5801	E240 (EXCAVATORS) CAT 3304 (S/N: 1FG1-UP)	
E120B (EXCAVATORS) MITSUBISHI 4D32 DIESEL (S/N: 4XK1-UP)		Oil Filter Full Flow.....	C-5505	Air Filter Secondary.....	A-5510
Fuel Filter Secondary.....	FC-5507	E200B (EXCAVATORS) MITSUBISHI 4D32 DIESEL (S/N: 4SG1-UP)		Air Filter Set.....	A-5522-S
E120B (EXCAVATORS) MITSUBISHI 4D32 DIESEL (S/N: 7NF1-UP)		Fuel Filter Secondary.....	FC-5507	Air Filter Primary.....	A-5509
Fuel Filter Secondary.....	FC-5507	E200B (EXCAVATORS) MITSUBISHI 4D32 DIESEL (S/N: 6KG1-UP)		Fuel Filter Secondary.....	FC-5507
E120B (EXCAVATORS) MITSUBISHI 54K-T (S/N: 6JF1-UP)		Fuel Filter.....	FC-5507	Hydraulic Oil Filter.....	H-5505
Air Filter Set.....	A-5663-S	E200B (EXCAVATORS) MITSUBISHI 56K-T (S/N: 6KF00234-UP)		Hydraulic Oil Filter.....	HC-5801
Air Filter Primary.....	A-5627	Air Filter Primary.....	A-5627	Oil Filter Full Flow.....	C-5510
Fuel Filter Secondary.....	FC-5507	Air Filter Set.....	A-5663-S	E240 (EXCAVATORS) CAT 3304 (S/N: 4JF1-UP)	
Fuel Filter Secondary.....	FC-55151	Fuel Filter Secondary.....	FC-5507	Air Filter Primary.....	A-5509
Fuel Filter Secondary.....	FC-5515	Fuel Filter.....	F-5505	Air Filter Set.....	A-5522-S
Fuel Filter.....	FC-5516	Hydraulic Oil Filter.....	H-5505	Air Filter Secondary.....	A-5520
Fuel Filter.....	F-5505	Hydraulic Oil Filter.....	HC-5801	Fuel Filter Secondary.....	FC-5507
Hydraulic Oil Filter.....	HC-5801	Oil Filter Full Flow.....	C-5510	Hydraulic Oil Filter.....	H-5505
Oil Filter Full Flow.....	C-5505	E200B (EXCAVATORS) MITSUBISHI 56K-T (S/N: 6KF1-00233-UP)		Hydraulic Oil Filter.....	HC-5801
E140 (EXCAVATORS) MITSUBISHI 4D32 DIESEL (S/N: 1NF9011-UP)		Air Filter Secondary.....	A-6007	Oil Filter Full Flow.....	C-5510
Fuel Filter.....	FC-1010	Air Filter Set.....	A-5663-S	E240 (EXCAVATORS) MITSUBISHI 4D32 DIESEL (S/N: 1FG1-UP)	
Hydraulic Oil Filter.....	HC-5801	Air Filter Primary.....	A-5627	Air Filter Set.....	A-5522-S
Oil Filter Combination.....	O-1006	Air Filter Set.....	A-6118-S	Air Filter Secondary.....	A-5510
E140 (EXCAVATORS) MITSUBISHI 6D14 (S/N: 1NF09041-UP)		Air Filter Primary.....	A-6006	Air Filter Primary.....	A-5509
Hydraulic Oil Filter.....	HC-5801	Fuel Filter.....	F-5505	Fuel Filter Secondary.....	FC-5507
E180 (EXCAVATORS) CAT 3204 (S/N: 1RF1-UP)		Fuel Filter Secondary.....	FC-5507	Hydraulic Oil Filter.....	H-5505
E180 (EXCAVATORS) MITSUBISHI 56K-T (S/N: 7DF1-UP)		Fuel Filter.....	FC-5516	Hydraulic Oil Filter.....	HC-5801
Air Filter Primary.....	A-6006	Fuel Filter Secondary.....	FC-5515	Oil Filter Full Flow.....	C-5510
E180 (EXCAVATORS) MITSUBISHI 56K-T (S/N: 7DF1-UP)		Fuel Filter Secondary.....	FC-55151	E240-EL240 (EXCAVATORS) S/N: 4JF1-UP	
Air Filter Primary.....	A-6006	Hydraulic Oil Filter.....	H-5505	Air Filter Primary.....	A-5509
E180 (EXCAVATORS) MITSUBISHI 56K-T (S/N: 7DF1-UP)		Oil Filter Full Flow.....	C-5510	Air Filter Set.....	A-5522-S
Air Filter Primary.....	A-6006	E200B (EXCAVATORS) MITSUBISHI 56K-T (S/N: 7DF1-UP)		Air Filter Secondary.....	A-5510
Air Filter Primary.....	A-6006	Air Filter Primary.....	A-6006	Air Filter Set.....	A-5549M-S
Fuel Filter Secondary.....	FC-5507	Fuel Filter Secondary.....	FC-5507	Air Filter Secondary.....	A-5550
Fuel Filter Secondary.....	FC-5507	Hydraulic Oil Filter.....	H-5505	Air Filter Primary.....	A-5549
Fuel Filter Secondary.....	FC-5507	Oil Filter Full Flow.....	C-5510	Air Filter Primary.....	A-5549M
Fuel Filter Secondary.....	FC-5507	E200B (EXCAVATORS) MITSUBISHI 56K-T (S/N: 7DF1-UP)		Fuel Filter Secondary.....	FC-5507
Fuel Filter Secondary.....	FC-5507	Air Filter Primary.....	A-6006		

Sakura Filter

ENGINE APPLICATION

MODEL/APPLICATION	SAKURA NO	MODEL/APPLICATION	SAKURA NO	MODEL/APPLICATION	SAKURA NO
CATERPILLAR		CATERPILLAR		CATERPILLAR	
EL200B (EXCAVATORS) S/N: 6FK1-UP		Hydraulic Oil Filter.....	H-5519	Air Filter Secondary.....	A-5525
Air Filter Secondary.....	A-6008	G3516 (GENERATORS) G3516		Air Filter Primary.....	A-5542
Fuel Filter Secondary.....	FC-5507	Air Filter.....	A-4403	Air Filter Set.....	A-5542-S
Hydraulic Oil Filter.....	HC-5801	Air Filter Set.....	A-4403-S	Fuel Filter.....	FC-5503
Hydraulic Oil Filter.....	H-5513	G3516B (GENERATORS) G3516B Gen Set		Hydraulic Oil Filter.....	H-5506
Hydraulic Oil Filter.....	H-5505	Air Filter Set.....	A-4403-S	Oil Filter Full Flow.....	C-5504
Oil Filter Full Flow.....	C-5510	Air Filter.....	A-4403	G916 (LOADERS) S/N: 8GD-UP	
EL200B (EXCAVATORS) S/N: 7DF1-UP		G3516B (GENERATORS) G3516B Gen Set Eng.		Air Filter Set.....	A-5542-S
Air Filter Secondary.....	A-6008	Air Filter.....	A-4403	Air Filter Primary.....	A-5542
Air Filter Primary.....	A-5627	G3516B (GENERATORS) G3516B Gen Set Eng.		Air Filter Secondary.....	A-5525
Air Filter Set.....	A-5663-S	Air Filter.....	A-4403	Fuel Filter.....	FC-5503
Fuel Filter Secondary.....	FC-5507	Air Filter Set.....	A-4403-S	Hydraulic Oil Filter.....	H-5506
Hydraulic Oil Filter.....	HC-5801	G3520B (GENERATORS) G3520B Gen Set Eng.		Oil Filter Full Flow.....	C-5504
Oil Filter Full Flow.....	C-5510	Air Filter.....	A-4403	G910 (LOADERS) S/N: 3SD1-UP	
EL240B (EXCAVATORS) CAT 3116 (S/N: 5WG1-UP)		Air Filter Set.....	A-4403-S	Air Filter Secondary.....	A-5525
Fuel Filter Secondary.....	FC-5507	G916 (LOADERS) CAT (S/N: 45V42589-UP)		Air Filter Primary.....	A-5542
Fuel Filter.....	F-5505	Fuel Filter.....	FC-5501	Air Filter Set.....	A-5542-S
Fuel Filter.....	FC-5516	Oil Filter Full Flow.....	C-5505	Fuel Filter Secondary.....	FC-5507
Fuel Filter Secondary.....	FC-5515	G916 (LOADERS) S/N: 1SD-UP		Fuel Filter.....	FC-5503
Fuel Filter Secondary.....	FC-55151	Air Filter Secondary.....	A-5525	Hydraulic Oil Filter.....	H-5504
Hydraulic Oil Filter.....	H-5505	Air Filter Set.....	A-5542-S	Hydraulic Oil Filter.....	H-55270
Hydraulic Oil Filter.....	HC-5801	Air Filter Primary.....	A-5542	Oil Filter Full Flow.....	C-5519
Oil Filter Full Flow.....	C-5510	Fuel Filter.....	FC-5503	G910 (LOADERS) S/N: 8GD1-UP	
EL240B (EXCAVATORS) CAT 3116 (S/N: 8SF1-UP)		Hydraulic Oil Filter.....	H-5506	Air Filter Set.....	A-5542-S
Fuel Filter Secondary.....	FC-55151	Oil Filter Full Flow.....	C-5504	Air Filter Primary.....	A-5542
Fuel Filter Secondary.....	FC-5515	G916 (LOADERS) S/N: 5GD1-45-UP		Air Filter Secondary.....	A-5525
Fuel Filter.....	FC-5516	Air Filter.....	A-5530	Fuel Filter Secondary.....	FC-5507
Fuel Filter.....	F-5505	Air Filter Primary.....	A-5507	Fuel Filter.....	FC-5503
Hydraulic Oil Filter.....	H-5505	Air Filter Set.....	A-5507-S	Hydraulic Oil Filter.....	H-55270
Hydraulic Oil Filter.....	HC-5801	Air Filter Set.....	A-55071-S	Hydraulic Oil Filter.....	H-5504
Oil Filter Full Flow.....	C-5510	Hydraulic Oil Filter.....	H-5501	Oil Filter Full Flow.....	C-5519
EL300 (EXCAVATORS) CAT 3306 (S/N: 2CF1-UP)		Hydraulic Oil Filter.....	H-5506	G910 (LOADERS) w/3204 Eng.	
Air Filter Set.....	A-5522-S	G916 (LOADERS) S/N: 5GD1-47		Air Filter Secondary.....	A-5590
Air Filter Secondary.....	A-5510	Air Filter Set.....	A-55071-S	G936 (LOADERS) S/N: 3HD1-UP	
Air Filter Primary.....	A-5509	Air Filter Set.....	A-5507-S	Air Filter Secondary.....	A-5522
Fuel Filter Secondary.....	FC-5507	Air Filter Primary.....	A-5507	Air Filter Set.....	A-5522-S
Hydraulic Oil Filter.....	H-5505	Air Filter.....	A-5530	Air Filter Primary.....	A-5509
Hydraulic Oil Filter.....	HC-5801	Fuel Filter.....	F-5505	Fuel Filter Secondary.....	FC-5507
Oil Filter Full Flow.....	C-5510	Fuel Filter Secondary.....	FC-5507	Fuel Filter.....	F-5505
EL300 (EXCAVATORS) CAT 3306 (S/N: 4NF1-UP)		Hydraulic Oil Filter.....	H-5506	Hydraulic Oil Filter.....	H-5506
Air Filter Primary.....	A-5509	Oil Filter Full Flow.....	C-5505	Oil Filter Full Flow.....	C-5510
Air Filter Secondary.....	A-5510	G916 (LOADERS) S/N: 5GD46-UP		G936 (LOADERS) S/N: 4ND1-UP	
Air Filter Set.....	A-5522-S	Air Filter Set.....	A-55071-S	Air Filter Secondary.....	A-5522
Fuel Filter Secondary.....	FC-5507	Air Filter Set.....	A-5507-S	Air Filter Primary.....	A-5509
Hydraulic Oil Filter.....	HC-5801	Air Filter Primary.....	A-5507	Air Filter Set.....	A-5522-S
Hydraulic Oil Filter.....	H-5505	Air Filter.....	A-5530	Fuel Filter.....	F-5505
Oil Filter Full Flow.....	C-5510	Fuel Filter.....	F-5505	Fuel Filter Secondary.....	FC-5507
EL70B (EXCAVATORS) S/N: 5TG1-752		Fuel Filter Secondary.....	FC-5507	Hydraulic Oil Filter.....	H-5506
Fuel Filter.....	FC-1016	Hydraulic Oil Filter.....	H-5506	Oil Filter Full Flow.....	C-5510
Hydraulic Oil Filter.....	H-5513	Oil Filter Full Flow.....	C-5505	G936 (LOADERS) S/N: 4SB-UP	
EL70B 5TG-ON (EXCAVATORS) w/Mitsubishi 4D32 Eng		G916 (LOADERS) S/N: 5GD-UP		Air Filter Primary.....	A-5549M
Fuel Filter.....	FC-1016	Air Filter.....	A-5530		
Hydraulic Oil Filter.....	H-5513	Air Filter Primary.....	A-5507		
		Air Filter Set.....	A-5507-S		
		Air Filter Set.....	A-55071-S		
		Hydraulic Oil Filter.....	H-5506		
		Hydraulic Oil Filter.....	H-5501		

Sakura Filter

ENGINE APPLICATION

MODEL/APPLICATION	SAKURA NO	MODEL/APPLICATION	SAKURA NO	MODEL/APPLICATION	SAKURA NO
CATERPILLAR		CATERPILLAR		CATERPILLAR	
G936 (LOADERS) S/N: 45B-UP		GC30N (FORKLIFTS) w/Mitsubishi K25 Eng.		GP20CN (FORKLIFTS) w/Mitsubishi K21 Eng.	
Air Filter Primary.....	A-5549	Air Filter Primary.....	A-85134	Air Filter Primary.....	A-85134
Air Filter Secondary.....	A-5550				
Air Filter Set.....	A-5549M-S	GC33N (FORKLIFTS) w/Mitsubishi K21 Eng.		GP20CN (FORKLIFTS) w/Mitsubishi K25 Eng.	
Air Filter Set.....	A-5522-S	Air Filter Primary.....	A-85134	Air Filter Primary.....	A-85134
Air Filter Primary.....	A-5509				
Fuel Filter Secondary.....	FC-5507	GC33N (FORKLIFTS) w/Mitsubishi K25 Eng.		GP20HN (FORKLIFTS) w/Mitsubishi K25 Eng.	
Fuel Filter.....	FC-5501	Air Filter Primary.....	A-85134	Air Filter Primary.....	A-85134
Hydraulic Oil Filter.....	H-5506				
Oil Filter Full Flow.....	C-5510	GC60K (FORKLIFTS) w/GM 4.3L Eng. , 4300		GP20N (FORKLIFTS) w/Mitsubishi K21 Eng.	
		Air Filter Secondary.....	A-5590	Air Filter Primary.....	A-85134
G936 (LOADERS) S/N: 45Z-UP		GE 110 (GENERATORS) CAT 3056		GP20N (FORKLIFTS) w/Mitsubishi K25 Eng.	
Air Filter Primary.....	A-5509	Air Filter Primary.....	AS-2212	Air Filter Primary.....	A-85134
Air Filter Set.....	A-5522-S	Air Filter Set.....	AS-2212-S		
Air Filter Set.....	A-5549M-S			GP20ZN (FORKLIFTS) w/Mitsubishi K25 Eng.	
Air Filter Secondary.....	A-5550	GEP550 (GENERATORS) PERKINS 2806C-E16TAG2		Air Filter Primary.....	A-85134
Air Filter Primary.....	A-5549	Air Filter Primary.....	A-8686	GP25HN (FORKLIFTS) w/Mitsubishi K25 Eng.	
Air Filter Primary.....	A-5549M-S	Air Filter Set.....	A-7627-S	Air Filter Primary.....	A-85134
Fuel Filter.....	FC-5501	Fuel Filter.....	EF-5101		
Fuel Filter Secondary.....	FC-5507	Fuel Filter.....	EF-5103	GP25N (FORKLIFTS) w/Mitsubishi K21 Eng.	
Hydraulic Oil Filter.....	H-5506	Oil Filter Full Flow.....	EO-5101	Air Filter Primary.....	A-85134
Oil Filter Full Flow.....	C-5510			GP25N (FORKLIFTS) w/Mitsubishi K25 Eng.	
		GP15N (FORKLIFTS) w/Mitsubishi K15 Eng.		Air Filter Primary.....	A-85134
		Air Filter Primary.....	A-85134	GP25N (FORKLIFTS) w/Mitsubishi K25 Eng.	
		GP15N (FORKLIFTS) w/Mitsubishi K21 Eng.		Air Filter Primary.....	A-85134
		Air Filter Primary.....	A-85134	GP25ZN (FORKLIFTS) w/Mitsubishi K25 Eng.	
		GP15N (FORKLIFTS) w/Mitsubishi K25 Eng.		Air Filter Primary.....	A-85134
		Air Filter Primary.....	A-85134	GP30N (FORKLIFTS) w/Mitsubishi K21 Eng.	
		GP15ZN (FORKLIFTS) w/Mitsubishi K15 Eng.		Air Filter Primary.....	A-85134
		Air Filter Primary.....	A-85134	GP30N (FORKLIFTS) w/Mitsubishi K25 Eng.	
		GP15ZN (FORKLIFTS) w/Mitsubishi K21 Eng.		Air Filter Primary.....	A-85134
		Air Filter Primary.....	A-85134	GP35N (FORKLIFTS) w/Mitsubishi K21 Eng.	
		GP15ZN (FORKLIFTS) w/Mitsubishi K25 Eng.		Air Filter Primary.....	A-85134
		Air Filter Primary.....	A-85134	GP35N (FORKLIFTS) w/Mitsubishi K25 Eng.	
		GP18N (FORKLIFTS) w/Mitsubishi K15 Eng.		Air Filter Primary.....	A-85134
		Air Filter Primary.....	A-85134	GP40 (FORKLIFTS) w/GM 4.3L Eng. , 4300	
		GP18N (FORKLIFTS) w/Mitsubishi K21 Eng.		Air Filter Secondary.....	A-5590
		Air Filter Primary.....	A-85134	GP40 (FORKLIFTS) w/Mitsubishi 6672 Eng.	
		GP18N (FORKLIFTS) w/Mitsubishi K25 Eng.		Air Filter Secondary.....	A-5590
		Air Filter Primary.....	A-85134	GP45 (FORKLIFTS) w/GM 4.3L Eng. , 4300	
		GP18ZN (FORKLIFTS) w/Mitsubishi K21 Eng.		Air Filter Secondary.....	A-5590
		Air Filter Primary.....	A-85134	GP45K (FORKLIFTS) w/Nissan TB45 (4.5L) Eng. , 4500	

MODEL/APPLICATION	SAKURA NO
CATERPILLAR	
IT12 (INTEGRATED TOOL-CARRIERS) S/N: 4NC1-UP	
Air Filter Set.....	A-5542-S
Air Filter Primary.....	A-5542
Air Filter Secondary.....	A-5525
Fuel Filter.....	FC-5503
Fuel Filter.....	F-5505
Fuel Filter Secondary.....	FC-5507
Hydraulic Oil Filter.....	H-55270
Hydraulic Oil Filter.....	H-5504
Oil Filter Full Flow.....	C-5519
IT12 (INTEGRATED TOOL-CARRIERS) w/3204 Eng.	
Air Filter Secondary.....	A-5590
IT12B (INTEGRATED TOOL-CARRIERS) S/N: 1KF1-819	
Oil Filter Full Flow.....	C-5505
IT12B (INTEGRATED TOOL-CARRIERS) S/N: 1KF1-UP	
Air Filter Primary.....	A-5511
Air Filter Set.....	A-5511-S
Air Filter Secondary.....	A-6008
Air Filter Set.....	A-5663-S
Air Filter Primary.....	A-5627
Cabin Air Filter.....	CA-5501
Fuel Filter.....	F-5505
Fuel Filter Secondary.....	FC-5507
Fuel Filter Secondary.....	FC-55151
Fuel Filter Secondary.....	FC-5515
Fuel Filter.....	FC-5516
Hydraulic Oil Filter.....	H-5510
Hydraulic Oil Filter.....	HC-5504
Oil Filter Full Flow.....	C-5505
IT14B (INTEGRATED TOOL-CARRIERS) CAT 3114 (S/N: 3NJ1-UP)	
Air Filter Set.....	A-5511-S
Air Filter Primary.....	A-5511
Cabin Air Filter.....	CA-5501
Fuel Filter Secondary.....	FC-5507
Fuel Filter.....	F-5505
Hydraulic Oil Filter.....	H-5510
Oil Filter Full Flow.....	C-5505
IT14B (INTEGRATED TOOL-CARRIERS) CAT 3114 (S/N: 9SF1-UP)	
Air Filter Primary.....	A-5511
Air Filter Set.....	A-5511-S
Cabin Air Filter.....	CA-5501
Fuel Filter Secondary.....	FC-5507
Hydraulic Oil Filter.....	H-5510
Oil Filter Full Flow.....	C-5505
IT14F (INTEGRATED TOOL-CARRIERS) S/N: 4EL1-UP	
Air Filter Primary.....	A-5627
Air Filter Set.....	A-5663-S
Air Filter Secondary.....	A-6008
Fuel Filter.....	F-5505
Fuel Filter.....	FC-5516
Fuel Filter Secondary.....	FC-5515

MODEL/APPLICATION	SAKURA NO
CATERPILLAR	
Fuel Filter Secondary.....	FC-55151
Hydraulic Oil Filter.....	H-5510
Hydraulic Oil Filter.....	HC-5504
Oil Filter Full Flow.....	C-5505
IT14G US (INTEGRATED TOOL-CARRIERS) CAT 3054 (S/N: 8ZM1-UP)	
Air Filter Set.....	A-5663-S
Air Filter Primary.....	A-5627
Fuel Filter.....	FS-5701
Hydraulic Oil Filter.....	HC-5504
Oil Filter Full Flow.....	C-5102
IT18 (INTEGRATED TOOL-CARRIERS) CAT 3204 (S/N: 7ZB1-UP) , 2005-UP	
Air Filter Primary.....	A-5507
Air Filter.....	A-5530
Air Filter Set.....	A-55071-S
Air Filter Set.....	A-5507-S
Fuel Filter Secondary.....	FC-5507
Fuel Filter.....	F-5505
Hydraulic Oil Filter.....	H-5506
Oil Filter Full Flow.....	C-5505
IT18 (INTEGRATED TOOL-CARRIERS) CAT 3204 (S/N: 9NB1-UP) , 2005-UP	
Air Filter Set.....	A-5507-S
Air Filter Set.....	A-55071-S
Air Filter.....	A-5530
Air Filter Primary.....	A-5507
Fuel Filter Secondary.....	FC-5507
Fuel Filter.....	F-5505
Hydraulic Oil Filter.....	H-5506
Oil Filter Full Flow.....	C-5505
IT18 (INTEGRATED TOOL-CARRIERS) CAT 3204	
Air Filter Primary.....	A-44180
Air Filter Set.....	A-44180-S
IT18 (INTEGRATED TOOL-CARRIERS) S/N: 4ZD-UP	
Air Filter Set.....	A-55071-S
Air Filter.....	A-5530
Air Filter Set.....	A-5507-S
Air Filter Primary.....	A-5507
Fuel Filter.....	FC-5519
Hydraulic Oil Filter.....	H-55270
Oil Filter Full Flow.....	C-5519
IT18 (INTEGRATED TOOL-CARRIERS) S/N: 7ZB1-UP	
Air Filter Secondary.....	A-5525
Air Filter Primary.....	A-5507
Air Filter Set.....	A-5507-S
Air Filter Set.....	A-55071-S
Air Filter Set.....	A-5568-S
Air Filter Secondary.....	A-5567
Air Filter Primary.....	A-5566
Fuel Filter.....	FC-5503
Oil Filter Full Flow.....	C-5505
IT18 (INTEGRATED TOOL-CARRIERS) S/N: 9NB1-9NB1	
Air Filter Primary.....	A-5566

MODEL/APPLICATION	SAKURA NO
CATERPILLAR	
Air Filter Secondary.....	A-5567
Air Filter Set.....	A-5568-S
Air Filter Set.....	A-55071-S
Air Filter.....	A-5530
Air Filter Set.....	A-5507-S
Air Filter Primary.....	A-5507
Fuel Filter Secondary.....	FC-5507
Hydraulic Oil Filter.....	H-5506
Oil Filter Full Flow.....	C-5505
IT18B (INTEGRATED TOOL-CARRIERS) CAT 3204 (S/N: 1DF1-UP) , 2005-UP	
Air Filter Primary.....	A-5507
Air Filter Set.....	A-5507-S
Air Filter Set.....	A-55071-S
Air Filter.....	A-5530
Fuel Filter.....	F-5505
Fuel Filter Secondary.....	FC-5507
Hydraulic Oil Filter.....	H-5506
Oil Filter Full Flow.....	C-5505
IT18B (INTEGRATED TOOL-CARRIERS) CAT 3204 (S/N: 2NJ340-UP) , 2005-UP	
Air Filter.....	A-5530
Air Filter Set.....	A-55071-S
Air Filter Set.....	A-5507-S
Air Filter Primary.....	A-5507
Fuel Filter Secondary.....	FC-5507
Fuel Filter.....	F-5505
Hydraulic Oil Filter.....	H-5506
Oil Filter Full Flow.....	C-5505
IT18B (INTEGRATED TOOL-CARRIERS) CAT 3204 (S/N: 4ZD1-UP)	
Air Filter Set.....	A-5507-S
Air Filter Set.....	A-55071-S
Air Filter.....	A-5530
Air Filter Primary.....	A-5507
Fuel Filter Secondary.....	FC-5507
Fuel Filter.....	F-5505
Hydraulic Oil Filter.....	H-5506
Oil Filter Full Flow.....	C-5505
IT18B (INTEGRATED TOOL-CARRIERS) S/N: 1DF1-UP	
Air Filter Secondary.....	A-5525
Air Filter Primary.....	A-5566
Air Filter Secondary.....	A-5567
Air Filter Set.....	A-5568-S
Air Filter Set.....	A-5507-S
Air Filter Primary.....	A-5507
Air Filter Set.....	A-55071-S
Fuel Filter.....	FC-5503
Hydraulic Oil Filter.....	H-5506
Oil Filter Full Flow.....	C-5505
IT18B (INTEGRATED TOOL-CARRIERS) S/N: 1DF-UP	
Air Filter Set.....	A-5568-S
Air Filter Secondary.....	A-5567
Air Filter Primary.....	A-5566
Air Filter Secondary.....	A-5525
Air Filter Set.....	A-55071-S
Air Filter Primary.....	A-5507

MODEL/APPLICATION	SAKURA NO
CATERPILLAR	
IT18B (INTEGRATED TOOL-CARRIERS) S/N: 1DF-UP	
Air Filter.....	A-5530
Air Filter Set.....	A-5507-S
Fuel Filter Secondary.....	FC-5507
Fuel Filter.....	FC-5501
Hydraulic Oil Filter.....	H-5506
Oil Filter Full Flow.....	C-5505
IT18B (INTEGRATED TOOL-CARRIERS) S/N: 2NJ1-UP	
Air Filter Primary.....	A-5566
Air Filter Secondary.....	A-5567
Air Filter Set.....	A-5568-S
IT18B (INTEGRATED TOOL-CARRIERS) S/N: 2NJ340-UP	
Air Filter Set.....	A-5507-S
Air Filter.....	A-5530
Air Filter Primary.....	A-5507
Air Filter Set.....	A-55071-S
Fuel Filter.....	F-5505
Fuel Filter Secondary.....	FC-5507
Hydraulic Oil Filter.....	H-5506
Oil Filter Full Flow.....	C-5505
IT18B (INTEGRATED TOOL-CARRIERS) S/N: 2NS-UP	
Air Filter Set.....	A-55071-S
Air Filter Primary.....	A-5507
Air Filter.....	A-5530
Air Filter Set.....	A-5507-S
Air Filter Set.....	A-5568-S
Air Filter Secondary.....	A-5567
Air Filter Primary.....	A-5566
Air Filter Secondary.....	A-5525
Fuel Filter Secondary.....	FC-5507
Fuel Filter.....	FC-5501
Hydraulic Oil Filter.....	H-5506
Oil Filter Full Flow.....	C-5505
IT18B (INTEGRATED TOOL-CARRIERS) S/N: 4ZD-UP	
Air Filter Set.....	A-5507-S
Air Filter.....	A-5530
Air Filter Primary.....	A-5507
Air Filter Set.....	A-55071-S
Air Filter Secondary.....	A-5525
Air Filter Primary.....	A-5566
Air Filter Secondary.....	A-5567
Air Filter Set.....	A-5568-S
Fuel Filter Secondary.....	FC-5507
Fuel Filter.....	FC-5501
Hydraulic Oil Filter.....	H-5506
Oil Filter Full Flow.....	C-5505
IT28 (INTEGRATED TOOL-CARRIERS) CAT 3204 (S/N: 2K1-UP) , 2005-UP	
Air Filter.....	A-5530
Air Filter Set.....	A-55071-S
Air Filter Set.....	A-5507-S
Air Filter Primary.....	A-5507
Fuel Filter.....	F-5505
Fuel Filter Secondary.....	FC-5507

MODEL/APPLICATION	SAKURA NO
CATERPILLAR	
Hydraulic Oil Filter.....	H-5506
Oil Filter Full Flow.....	C-5505
IT28 (INTEGRATED TOOL-CARRIERS) CAT 3204 (S/N: 8JB1-UP) , 2005-UP	
Air Filter Set.....	A-55071-S
Air Filter.....	A-5530
Air Filter Primary.....	A-5507
Air Filter Set.....	A-5507-S
Fuel Filter Secondary.....	FC-5507
Fuel Filter.....	F-5505
Hydraulic Oil Filter.....	H-5506
Oil Filter Full Flow.....	C-5505
IT28 (INTEGRATED TOOL-CARRIERS) S/N: 1HF1-UP	
Air Filter Set.....	A-55071-S
Air Filter Set.....	A-5507-S
Air Filter Primary.....	A-5507
Air Filter.....	A-5530
Fuel Filter.....	FC-5501
Hydraulic Oil Filter.....	H-5506
Oil Filter Full Flow.....	C-5505
IT28 (INTEGRATED TOOL-CARRIERS) S/N: 2K1-UP	
Air Filter Primary.....	A-5566
Air Filter.....	A-5530
Air Filter Secondary.....	A-5567
Air Filter Primary.....	A-5507
Air Filter Set.....	A-5568-S
Air Filter Set.....	A-5507-S
Air Filter Set.....	A-55071-S
Fuel Filter Secondary.....	FC-5507
Fuel Filter.....	FC-5501
Hydraulic Oil Filter.....	H-5506
Oil Filter Full Flow.....	C-5505
IT28 (INTEGRATED TOOL-CARRIERS) S/N: 5D1-UP	
Air Filter Set.....	A-55071-S
Air Filter Set.....	A-5507-S
Air Filter Primary.....	A-5507
Air Filter.....	A-5530
Fuel Filter.....	FC-5501
Hydraulic Oil Filter.....	H-5506
Oil Filter Full Flow.....	C-5505
IT28 (INTEGRATED TOOL-CARRIERS) S/N: 8JB1-UP	
Air Filter Primary.....	A-5566
Air Filter Secondary.....	A-5567
Air Filter Primary.....	A-5507
Air Filter Set.....	A-5568-S
Air Filter Set.....	A-5507-S
Air Filter Set.....	A-55071-S
Air Filter Secondary.....	A-5525
Fuel Filter.....	FC-5503
Oil Filter Full Flow.....	C-5505
IT28B (INTEGRATED TOOL-CARRIERS) CAT 3204 (S/N: 5D1-UP)	
Air Filter.....	A-5530
Fuel Filter Secondary.....	FC-5507

MODEL/APPLICATION	SAKURA NO
CATERPILLAR	
Fuel Filter.....	F-5505
Hydraulic Oil Filter.....	H-5506
Oil Filter Full Flow.....	C-5505
IT28B (INTEGRATED TOOL-CARRIERS) CAT 3204 (S/N: 74V02305-UP)	
Air Filter Secondary.....	A-5508
Fuel Filter Secondary.....	FC-5507
Hydraulic Oil Filter.....	H-5504
Oil Filter Full Flow.....	C-5510
IT28B (INTEGRATED TOOL-CARRIERS) S/N: 1HF1-UP	
Air Filter Primary.....	A-5507
Air Filter Primary.....	A-5566
Air Filter Secondary.....	A-5567
Air Filter Set.....	A-5568-S
Air Filter.....	A-5530
Air Filter Set.....	A-5507-S
Air Filter Set.....	A-55071-S
Fuel Filter Secondary.....	FC-5507
Fuel Filter.....	FC-5501
Hydraulic Oil Filter.....	H-5506
Oil Filter Full Flow.....	C-5505
IT28B (INTEGRATED TOOL-CARRIERS) S/N: 1JK430-UP	
Air Filter Set.....	A-55071-S
Air Filter Set.....	A-5507-S
Air Filter.....	A-5530
Air Filter Primary.....	A-5507
Fuel Filter.....	F-5505
Fuel Filter Secondary.....	FC-5507
Hydraulic Oil Filter.....	H-5506
Oil Filter Full Flow.....	C-5505
IT28B (INTEGRATED TOOL-CARRIERS) S/N: 5D1302-UP	
Air Filter.....	A-5530
Air Filter Set.....	A-5507-S
Air Filter Set.....	A-55071-S
Air Filter Primary.....	A-5507
Fuel Filter Secondary.....	FC-5507
Fuel Filter.....	F-5505
Hydraulic Oil Filter.....	H-5506
Oil Filter Full Flow.....	C-5505
IT28G (INTEGRATED TOOL-CARRIERS) CAT 3116 (S/N: 8CR1-UP) , 2005-UP	
Air Filter Primary.....	A-5566
Air Filter Secondary.....	A-5567
Air Filter Set.....	A-5568-S
Fuel Filter.....	FC-5508
Fuel Filter.....	FC-5516
Fuel Filter Secondary.....	FC-55151
Fuel Filter Secondary.....	FC-5515
Hydraulic Oil Filter.....	HC-5504
Oil Filter Full Flow.....	C-5510
IT28G (INTEGRATED TOOL-CARRIERS) CAT 3116 (S/N: 9AR1-UP) , 2005-UP	
Air Filter Set.....	A-5568-S
Air Filter Secondary.....	A-5567
Air Filter Primary.....	A-5566
Fuel Filter Secondary.....	FC-5515

MODEL/APPLICATION SAKURA NO

CATERPILLAR

IT28G
(INTEGRATED TOOL-CARRIERS)
CAT 3116 (S/N: 9AR1-UP) , 2005-UP

Fuel Filter Secondary..... FC-55151
Fuel Filter..... FC-5516
Hydraulic Oil Filter..... HC-5504
Oil Filter Full Flow..... C-5510

IT28G
(INTEGRATED TOOL-CARRIERS)
CAT 3116 (S/N: DBT1-UP) , 2005-UP

Air Filter Primary..... AS-8577
Air Filter Secondary..... A-8578
Hydraulic Oil Filter..... HC-5504
Oil Filter Full Flow..... C-5510

IT28G
(INTEGRATED TOOL-CARRIERS)
CAT 3116 (S/N: WAC1-UP) , 2005-UP

Air Filter Secondary..... A-8578
Air Filter Primary..... AS-8577
Hydraulic Oil Filter..... HC-5504
Oil Filter Full Flow..... C-5510

IT28G
(INTEGRATED TOOL-CARRIERS)
CAT 3116

Air Filter Set..... A-5568-S
Air Filter Secondary..... A-5567
Air Filter Primary..... A-5566
Fuel Filter..... FC-5508
Fuel Filter..... FC-5516
Fuel Filter Secondary..... FC-55151
Fuel Filter Secondary..... FC-5515
Hydraulic Oil Filter..... HC-5504
Oil Filter Full Flow..... C-5510

IT28G
(INTEGRATED TOOL-CARRIERS)
CAT 3056E

Air Filter Secondary..... A-8578
Air Filter Primary..... AS-8577
Fuel Filter Secondary..... FC-5515
Fuel Filter Secondary..... FC-55151
Fuel Filter..... FC-5516
Fuel Filter..... FC-5508
Hydraulic Oil Filter..... HC-5504
Oil Filter Full Flow..... C-5510

IT24F
(INTEGRATED TOOL-CARRIERS)
CAT 3114 (S/N: 4NN1-UP)

Air Filter Secondary..... A-5567
Air Filter Primary..... A-5566
Air Filter Set..... A-5568-S
Fuel Filter..... FC-5516
Fuel Filter..... F-5505
Fuel Filter Secondary..... FC-5515
Fuel Filter Secondary..... FC-55151
Hydraulic Oil Filter..... H-5506
Hydraulic Oil Filter..... HC-5504
Oil Filter Full Flow..... C-5510
Oil Filter Full Flow..... C-5505

IT24F
(INTEGRATED TOOL-CARRIERS)
CAT 3114 (S/N: 6KN1-UP)

Air Filter Set..... A-5568-S
Air Filter Primary..... A-5566
Air Filter Secondary..... A-5567
Fuel Filter Secondary..... FC-55151
Fuel Filter..... F-5505
Fuel Filter Secondary..... FC-5515
Hydraulic Oil Filter..... H-5506
Hydraulic Oil Filter..... HC-5504
Oil Filter Full Flow..... C-5510

MODEL/APPLICATION SAKURA NO

CATERPILLAR

Fuel Filter Secondary..... FC-5515
Fuel Filter..... FC-5516
Hydraulic Oil Filter..... HC-5504
Hydraulic Oil Filter..... H-5506
Oil Filter Full Flow..... C-5505
Oil Filter Full Flow..... C-5510

IT24F
(INTEGRATED TOOL-CARRIERS)
S/N: 4NN1-UP

Air Filter Secondary..... A-5567
Air Filter Primary..... A-5566
Air Filter Set..... A-5568-S
Fuel Filter..... FC-5516
Fuel Filter Secondary..... FC-5515
Fuel Filter Secondary..... FC-55151
Hydraulic Oil Filter..... H-5506
Hydraulic Oil Filter..... HC-5508
Oil Filter Full Flow..... C-5505

IT24F
(INTEGRATED TOOL-CARRIERS)
S/N: 6KN1-UP

Air Filter Secondary..... A-5567
Fuel Filter Secondary..... FC-55151
Fuel Filter Secondary..... FC-5515
Fuel Filter..... FC-5516
Hydraulic Oil Filter..... HC-5508
Hydraulic Oil Filter..... H-5506
Oil Filter Full Flow..... C-5505

IT24F UK
(INTEGRATED TOOL-CARRIERS)
CAT 3056E (S/N: 6KN1-UP) , 2005-UP

Air Filter Set..... A-5568-S
Air Filter Secondary..... A-5567
Air Filter Primary..... A-5566
Cabin Air Filter..... CA-55070
Fuel Filter..... F-5505
Fuel Filter..... FC-5516
Fuel Filter Secondary..... FC-55151
Fuel Filter Secondary..... FC-5515
Hydraulic Oil Filter..... H-5506
Hydraulic Oil Filter..... HC-5504
Oil Filter Full Flow..... C-5505

IT28F
(INTEGRATED TOOL-CARRIERS)
CAT 3116 (S/N: 1JL1-UP) , 2005-UP

Air Filter Primary..... A-5566
Air Filter Set..... A-5568-S
Air Filter Secondary..... A-5567
Cabin Air Filter..... CA-55070
Fuel Filter..... FC-5516
Fuel Filter Secondary..... FC-5515
Fuel Filter Secondary..... FC-55151
Fuel Filter..... F-5505
Hydraulic Oil Filter..... H-5506
Hydraulic Oil Filter..... HC-5504
Oil Filter Full Flow..... C-5510

IT28F
(INTEGRATED TOOL-CARRIERS)
S/N: 3CL1-UP

Air Filter Set..... A-5568-S
Air Filter Secondary..... A-5567
Air Filter Primary..... A-5566
Fuel Filter..... FC-5516
Fuel Filter Secondary..... FC-55151
Fuel Filter Secondary..... FC-5515
Hydraulic Oil Filter..... H-5506
Hydraulic Oil Filter..... HC-5508
Oil Filter Full Flow..... C-5510

IT28G EN
(INTEGRATED TOOL-CARRIERS)
CAT 3056E (S/N: 9AR1-UP)

Air Filter Set..... A-5568-S
Air Filter Secondary..... A-5567
Air Filter Primary..... A-5566
Fuel Filter..... F-5505
Fuel Filter..... FC-5516
Fuel Filter Secondary..... FC-55151

MODEL/APPLICATION SAKURA NO

CATERPILLAR

Fuel Filter Secondary..... FC-5515
Fuel Filter..... FC-5516
Fuel Filter..... F-5505
Hydraulic Oil Filter..... HC-5504
Hydraulic Oil Filter..... H-5506
Oil Filter Full Flow..... C-5510

IT28F
(INTEGRATED TOOL-CARRIERS)
CAT 3116 (S/N: 3CL1200-UP) , 2005-UP

Air Filter Primary..... A-5566
Air Filter Set..... A-5568-S
Air Filter Secondary..... A-5567
Cabin Air Filter..... CA-55070
Fuel Filter Secondary..... FC-5515
Fuel Filter Secondary..... FC-55151
Fuel Filter..... FC-5516
Hydraulic Oil Filter..... HC-5504
Hydraulic Oil Filter..... H-5506
Oil Filter Full Flow..... C-5510

IT28F
(INTEGRATED TOOL-CARRIERS)
S/N: 1JL1-UP

Air Filter Set..... A-5568-S
Air Filter Secondary..... A-5567
Air Filter Primary..... A-5566
Fuel Filter..... FC-5516
Fuel Filter Secondary..... FC-55151
Fuel Filter Secondary..... FC-5515
Hydraulic Oil Filter..... HC-5508
Hydraulic Oil Filter..... H-5506
Oil Filter Full Flow..... C-5510

IT28F
(INTEGRATED TOOL-CARRIERS)
S/N: 3CL1200-UP

Air Filter Primary..... A-5566
Air Filter Secondary..... A-5567
Air Filter Set..... A-5568-S
Fuel Filter Secondary..... FC-5515
Fuel Filter Secondary..... FC-55151
Fuel Filter..... FC-5516
Hydraulic Oil Filter..... H-5506
Hydraulic Oil Filter..... HC-5504
Oil Filter Full Flow..... C-5510

IT28F
(INTEGRATED TOOL-CARRIERS)
S/N: 3CL1-UP

Air Filter Set..... A-5568-S
Air Filter Secondary..... A-5567
Air Filter Primary..... A-5566
Fuel Filter..... FC-5516
Fuel Filter Secondary..... FC-55151
Fuel Filter Secondary..... FC-5515
Hydraulic Oil Filter..... H-5506
Hydraulic Oil Filter..... HC-5508
Oil Filter Full Flow..... C-5510

MODEL/APPLICATION	SAKURA NO	MODEL/APPLICATION	SAKURA NO	MODEL/APPLICATION	SAKURA NO
CATERPILLAR		CATERPILLAR		CATERPILLAR	
IT28G EN <i>(INTEGRATED TOOL-CARRIERS)</i> CAT 3056E (S/N: 9AR1-UP)		IT38F <i>(INTEGRATED TOOL-CARRIERS)</i> S/N: 6NF1-UP		IT38G <i>(INTEGRATED TOOL-CARRIERS)</i> S/N: 1CW329-UP	
Fuel Filter Secondary.....	FC-5515	Air Filter Primary.....	A-5549M	Air Filter Secondary.....	A-5550
Hydraulic Oil Filter.....	H-5506	Air Filter Primary.....	A-5549	Fuel Filter Secondary.....	FC-5515
Hydraulic Oil Filter.....	HC-5504	Air Filter Secondary.....	A-5550	Fuel Filter.....	FC-5516
Oil Filter Full Flow.....	C-5505	Air Filter Set.....	A-5549M-S	Fuel Filter Secondary.....	FC-55151
IT28G US <i>(INTEGRATED TOOL-CARRIERS)</i> CAT 3056E (S/N: 8CR1-UP) , 2005-UP		IT38G <i>(INTEGRATED TOOL-CARRIERS)</i> CAT 3126 (S/N: 1CW1-328) , 2005-UP		IT38G <i>(INTEGRATED TOOL-CARRIERS)</i> S/N: 7BS1-UP	
Air Filter Primary.....	A-5566	Air Filter Secondary.....	A-5550	Air Filter Primary.....	A-5549
Air Filter Secondary.....	A-5567	Fuel Filter Secondary.....	FC-5515	Air Filter Secondary.....	A-5550
Air Filter Set.....	A-5568-S	Fuel Filter.....	FC-5516	Air Filter Set.....	A-5549M-S
Fuel Filter Secondary.....	FC-5515	Fuel Filter.....	F-5505	Air Filter Primary.....	A-5549
Fuel Filter Secondary.....	FC-55151	Hydraulic Oil Filter.....	H-5506	Fuel Filter.....	F-5505
Fuel Filter.....	FC-5516	Hydraulic Oil Filter.....	HC-5504	Fuel Filter.....	FC-5516
Fuel Filter.....	F-5505	Hydraulic Oil Filter.....	HC-5504	Fuel Filter Secondary.....	FC-55151
Hydraulic Oil Filter.....	H-5506	Oil Filter Full Flow.....	C-5505	Fuel Filter Secondary.....	FC-5515
Hydraulic Oil Filter.....	HC-5504	IT38F <i>(INTEGRATED TOOL-CARRIERS)</i> CAT 3116 (S/N: 5DR1-270) , 2005-UP		Fuel Filter Secondary.....	FC-5515
Oil Filter Full Flow.....	C-5505	Air Filter Secondary.....	A-5550	Hydraulic Oil Filter.....	HC-5504
IT38F <i>(INTEGRATED TOOL-CARRIERS)</i> CAT 3116 (S/N: 5DR1-270) , 2005-UP		Air Filter Primary.....	A-5549M	Hydraulic Oil Filter.....	H-5506
Air Filter Secondary.....	A-5550	Air Filter Set.....	A-5549M-S	Hydraulic Oil Filter.....	H-5506
Air Filter Primary.....	A-5549M	Air Filter Primary.....	A-5549	Oil Filter Full Flow.....	C-5510
Air Filter Set.....	A-5549M-S	Fuel Filter.....	F-5505	IT38G <i>(INTEGRATED TOOL-CARRIERS)</i> CAT 3126 (S/N: 1CW329-UP) , 2005-UP	
Air Filter Primary.....	A-5549	Fuel Filter.....	FC-5516	Air Filter Secondary.....	A-5550
Fuel Filter.....	F-5505	Fuel Filter.....	FC-5516	Fuel Filter.....	FC-5508
Fuel Filter.....	FC-5516	Fuel Filter.....	FC-5516	Fuel Filter.....	FC-5516
Fuel Filter Secondary.....	FC-55151	Fuel Filter Secondary.....	FC-55151	Fuel Filter Secondary.....	FC-55151
Fuel Filter Secondary.....	FC-5515	Fuel Filter Secondary.....	FC-5515	Fuel Filter Secondary.....	FC-5515
Hydraulic Oil Filter.....	HC-5504	Fuel Filter Secondary.....	FC-5515	Hydraulic Oil Filter.....	HC-5504
Hydraulic Oil Filter.....	H-5506	Hydraulic Oil Filter.....	HC-5504	Hydraulic Oil Filter.....	H-5506
Oil Filter Full Flow.....	C-5510	Hydraulic Oil Filter.....	H-5506	Oil Filter Full Flow.....	C-5510
IT38F <i>(INTEGRATED TOOL-CARRIERS)</i> CAT 3116 (S/N: 5DR271-UP) , 2005-UP		Oil Filter Full Flow.....	C-5510	IT38G II <i>(INTEGRATED TOOL-CARRIERS)</i> CAT (S/N: 5GG1-UP)	
Air Filter Primary.....	A-5549	IT38G <i>(INTEGRATED TOOL-CARRIERS)</i> CAT 3126 (S/N: 7BS1-UP) , 2005-UP		Fuel Filter.....	FC-5517
Air Filter Set.....	A-5549M-S	Air Filter Primary.....	A-5549	Oil Filter Full Flow.....	C-5522
Air Filter Primary.....	A-5549M	Air Filter Primary.....	A-5549M	IT38G II <i>(INTEGRATED TOOL-CARRIERS)</i> CAT (S/N: BMA28000-UP)	
Air Filter Secondary.....	A-5550	Air Filter Secondary.....	A-5550	Fuel Filter.....	FC-5517
Fuel Filter Secondary.....	FC-5515	Air Filter Set.....	A-5549M-S	Oil Filter Full Flow.....	C-5522
Fuel Filter Secondary.....	FC-55151	Fuel Filter Secondary.....	FC-5515	IT38G II <i>(INTEGRATED TOOL-CARRIERS)</i> S/N: CSX1-UP	
Fuel Filter.....	FC-5516	Fuel Filter Secondary.....	FC-55151	Air Filter Primary.....	A-5558
Fuel Filter.....	FC-5508	Fuel Filter.....	FC-5516	Air Filter Secondary.....	A-5559
Hydraulic Oil Filter.....	H-5506	Fuel Filter.....	FC-5508	Hydraulic Oil Filter.....	H-5506
Hydraulic Oil Filter.....	HC-5504	Hydraulic Oil Filter.....	H-5506	Hydraulic Oil Filter.....	HC-5504
Oil Filter Full Flow.....	C-5510	Hydraulic Oil Filter.....	HC-5504	IT38G II <i>(INTEGRATED TOOL-CARRIERS)</i> S/N: JAN1-UP	
IT38F <i>(INTEGRATED TOOL-CARRIERS)</i> CAT 3116 (S/N: 6NF1-UP) , 2005-UP		Oil Filter Full Flow.....	C-5510	Air Filter Secondary.....	A-5559
Air Filter Secondary.....	A-5550	IT38G <i>(INTEGRATED TOOL-CARRIERS)</i> CAT 3126 (S/N: CSX1-UP) , 2005-UP		Air Filter Primary.....	A-5558
Air Filter Primary.....	A-5549M	Air Filter Secondary.....	A-5559	Hydraulic Oil Filter.....	HC-5504
Air Filter Set.....	A-5549M-S	Air Filter Primary.....	A-5558	Hydraulic Oil Filter.....	H-5506
Air Filter Primary.....	A-5549	Fuel Filter.....	FC-5517	IT38H <i>(INTEGRATED TOOL-CARRIERS)</i> CAT 6.6 ACERT	
Fuel Filter.....	FC-5508	Hydraulic Oil Filter.....	HC-5504	Fuel/Water Separator.....	SFC-55240
Fuel Filter.....	F-5505	Hydraulic Oil Filter.....	H-5506	IT38H <i>(INTEGRATED TOOL-CARRIERS)</i> w/C6.6 Eng.	
Fuel Filter.....	FC-5516	Oil Filter Full Flow.....	C-5510	Hydraulic Oil Filter.....	HC-55280
Fuel Filter Secondary.....	FC-55151	IT38G <i>(INTEGRATED TOOL-CARRIERS)</i>		IT38H <i>(INTEGRATED TOOL-CARRIERS)</i>	
Fuel Filter Secondary.....	FC-5515	Air Filter Primary.....	A-5549	IT38H <i>(INTEGRATED TOOL-CARRIERS)</i>	
Hydraulic Oil Filter.....	HC-5504	Air Filter Primary.....	A-5549M	IT38H <i>(INTEGRATED TOOL-CARRIERS)</i>	
Hydraulic Oil Filter.....	H-5506	Air Filter Set.....	A-5549M-S	IT38H <i>(INTEGRATED TOOL-CARRIERS)</i>	
Oil Filter Full Flow.....	C-5510	IT38G <i>(INTEGRATED TOOL-CARRIERS)</i>		IT38H <i>(INTEGRATED TOOL-CARRIERS)</i>	

MODEL/APPLICATION	SAKURA NO	MODEL/APPLICATION	SAKURA NO	MODEL/APPLICATION	SAKURA NO
CATERPILLAR		CATERPILLAR		CATERPILLAR	
IT62G (INTEGRATED TOOL-CARRIERS) CAT 3126 (S/N: 6PS1-UP) , 2005-UP		IT62H (INTEGRATED TOOL-CARRIERS) CAT S/N: C7C1-UP		Fuel/Water Separator.....	SFC-43040
Air Filter.....	A-25460	Cabin Air Filter.....	CA-55070	M313D (EXCAVATORS) CAT (S/N: C4E1-UP)	
Air Filter Secondary.....	A-5550	Fuel Filter.....	FC-5517	Oil Filter Full Flow.....	C-5102
Air Filter.....	A-5584	Hydraulic Oil Filter.....	HC-5504	M313D (EXCAVATORS) CAT (S/N: C4E2-UP)	
Fuel Filter.....	FC-5516	Oil Filter Full Flow.....	C-5522	Oil Filter Full Flow.....	C-5102
Fuel Filter Secondary.....	FC-55151	IT62H (INTEGRATED TOOL-CARRIERS) CAT S/N: M5G1-UP		M313D (EXCAVATORS) S/N: W3H1-UP	
Fuel Filter Secondary.....	FC-5515	Cabin Air Filter.....	CA-55070	Cabin Air Filter.....	CA-55850
Fuel Filter.....	FC-5508	Fuel Filter.....	FC-5517	M315 (EXCAVATORS) CAT 3054 (S/N: 7ML1-UP)	
Hydraulic Oil Filter.....	HC-5504	Hydraulic Oil Filter.....	HC-5504	Air Filter Secondary.....	A-5540
Oil Filter Full Flow.....	C-5510	Oil Filter Full Flow.....	C-5522	Oil Filter Full Flow.....	C-5102
IT62G (INTEGRATED TOOL-CARRIERS) CAT 3126 (S/N: AKP1-UP) , 2005-UP		IT62H (INTEGRATED TOOL-CARRIERS) w/C7 Eng.		M315 (EXCAVATORS) S/N: 7ML01824-UP	
Air Filter.....	A-5584	Hydraulic Oil Filter.....	HC-55280	Air Filter Primary.....	A-5541M
Air Filter Secondary.....	A-5550	LEXION 450 (TRACTORS) CAT 3126		Air Filter Primary.....	A-5541
Fuel Filter.....	FC-5508	Fuel Filter.....	FC-5516	Air Filter Set.....	A-5541M-S
Fuel Filter Secondary.....	FC-5507	Fuel Filter Secondary.....	FC-5515	Air Filter Primary.....	A-76231
Fuel Filter Secondary.....	FC-5515	Fuel Filter Secondary.....	FC-55151	Air Filter Secondary.....	A-5540
Fuel Filter Secondary.....	FC-55151	Fuel/Water Separator Secondary..	SFC-5504-10	Oil Filter Full Flow.....	C-5102
Fuel Filter.....	FC-5516	Fuel/Water Separator Secondary..	SFC-5504-10B	M315 (EXCAVATORS) S/N: 7ML860-UP	
Hydraulic Oil Filter.....	HC-5504	Oil Filter Full Flow.....	C-5510	Air Filter Primary.....	A-76231
Oil Filter Full Flow.....	C-5510	LEXION 460 (COMBINES HARVESTERS) CAT 3126		Air Filter Set.....	A-5541M-S
IT62G (INTEGRATED TOOL-CARRIERS) CAT 3126 (S/N: AYA1-UP) , 2005-UP		Fuel Filter Secondary.....	FC-55151	Air Filter Primary.....	A-5541
Air Filter Secondary.....	A-5559	Fuel Filter Secondary.....	FC-5515	Air Filter Primary.....	A-5541M
Air Filter Primary.....	A-5558	Fuel Filter.....	FC-5516	Air Filter Secondary.....	A-5540
Cabin Air Filter.....	CA-55070	Oil Filter Full Flow.....	C-5510	Oil Filter Full Flow.....	C-5102
Fuel Filter.....	FC-5517	LEXION 460 (COMBINES HARVESTERS) CAT C9		M315C (EXCAVATORS) CAT 3054 (S/N: BDM1-UP) , 2004-UP	
Hydraulic Oil Filter.....	HC-5504	Fuel Filter.....	FC-5517	Air Filter Primary.....	A-5105
Oil Filter Full Flow.....	C-5510	LEXION 475R (TRACTORS) CAT C9		Air Filter Secondary.....	A-5106
IT62G (INTEGRATED TOOL-CARRIERS) S/N: 6PS1-UP		Fuel/Water Separator Secondary..	SFC-5504-10B	Cabin Air Filter.....	CA-55850
Air Filter Secondary.....	A-5550	Fuel/Water Separator Secondary..	SFC-5504-10	M315C (EXCAVATORS) w/3054, 3054E Eng.	
Fuel Filter.....	FC-5516	Oil Filter Full Flow.....	C-5516	Fuel/Water Separator.....	SFC-43040
Fuel Filter Secondary.....	FC-55151	LEXION 480 (COMBINES HARVESTERS) CAT 3176		M315D (EXCAVATORS) CAT (S/N: C4E1-1-UP)	
Fuel Filter Secondary.....	FC-5515	Air Filter Primary.....	A-5509	Oil Filter Full Flow.....	C-5102
Fuel Filter.....	FC-5508	Air Filter Secondary.....	A-5522	M315D (EXCAVATORS) CAT (S/N: C4E2-UP)	
Hydraulic Oil Filter.....	HC-5504	Air Filter Set.....	A-5522-S	Oil Filter Full Flow.....	C-5102
Oil Filter Full Flow.....	C-5510	Fuel Filter.....	FC-5519	M315D (EXCAVATORS) CAT C4.4 ACERT	
IT62G II (INTEGRATED TOOL-CARRIERS) CAT (S/N: AYA1-UP)		LEXION 480 (COMBINES HARVESTERS) CAT C12		Fuel/Water Separator.....	SFC-55240
Air Filter Secondary.....	A-5559	Fuel Filter.....	FC-5517	M315D (EXCAVATORS) S/N: W5M1-UP	
Air Filter Primary.....	A-5558	LEXION 410 (TRACTORS) CAT 3126B		Cabin Air Filter.....	CA-55850
Cabin Air Filter.....	CA-55070	Fuel Filter.....	FC-5517	M316C (EXCAVATORS) CAT 3056 (S/N: BDX1-09999-UP) , 2002-UP	
Fuel Filter.....	FC-5517	Oil Filter Full Flow.....	C-5510	Air Filter Secondary.....	A-5106
Hydraulic Oil Filter.....	HC-5504	M312 (EXCAVATORS) CAT 3054 (S/N: 6TL1-UP)		Air Filter Primary.....	A-5105
Oil Filter Full Flow.....	C-5522	Air Filter Secondary.....	A-5540	Cabin Air Filter.....	CA-55850
IT62G II (INTEGRATED TOOL-CARRIERS) CAT (S/N: AYA1-UP)		Oil Filter Full Flow.....	C-5102	Oil Filter Full Flow.....	C-5101
Air Filter Secondary.....	A-5559	M313C (EXCAVATORS) w/3054, 3054E Eng.			
Air Filter Primary.....	A-5558				
Cabin Air Filter.....	CA-55070				
Fuel Filter.....	FC-5517				
Hydraulic Oil Filter.....	HC-5504				
Oil Filter Full Flow.....	C-5522				

MODEL/APPLICATION	SAKURA NO	MODEL/APPLICATION	SAKURA NO	MODEL/APPLICATION	SAKURA NO
CATERPILLAR		CATERPILLAR		CATERPILLAR	
M316C (EXCAVATORS) CAT 3056 (S/N: BDX1-UP) Air Filter Primary..... A-5105 Air Filter Secondary..... A-5106 Cabin Air Filter..... CA-55850 Oil Filter Full Flow..... C-5101		Air Filter Primary..... AS-5523 Fuel Filter Secondary..... FC-5515 Fuel Filter..... FC-5516 Fuel Filter Secondary..... FC-55151 Oil Filter Full Flow..... C-5510		Air Filter Secondary..... A-7913 Air Filter Primary..... AS-5523 Fuel Filter Secondary..... FC-5515 Fuel Filter Secondary..... FC-55151 Fuel Filter..... FC-5516 Oil Filter Full Flow..... C-5510	
M316D (EXCAVATORS) CAT S/N: C6E1-UP Cabin Air Filter..... CA-55850 Fuel Filter..... FC-5516 Fuel Filter Secondary..... FC-5515 Fuel Filter Secondary..... FC-55151		M318C (EXCAVATORS) CAT 3056 (S/N: BCZ1-09999-UP) , 2004-UP Air Filter Primary..... A-5105 Air Filter Secondary..... A-5106 Cabin Air Filter..... CA-55850 Oil Filter Full Flow..... C-5101		M318 HDU (EXCAVATORS) CAT 3054 (S/N: 85S1-UP) Air Filter Primary..... AS-5523 Air Filter Secondary..... A-7913 Fuel Filter Secondary..... FC-55151 Fuel Filter Secondary..... FC-5515 Fuel Filter..... FC-5516 Oil Filter Full Flow..... C-5510	
M316D (EXCAVATORS) CAT S/N: W6A1-UP Cabin Air Filter..... CA-55850 Fuel Filter Secondary..... FC-55151 Fuel Filter Secondary..... FC-5515 Fuel Filter..... FC-5516		M318C (EXCAVATORS) CAT 3056 (S/N: BCZ1-UP) , 2004-UP Air Filter Secondary..... A-5106 Air Filter Primary..... A-5105 Cabin Air Filter..... CA-55850 Oil Filter Full Flow..... C-5101		M318 STD (EXCAVATORS) CAT 3054 (S/N: 8AL1-UP) Air Filter Primary..... AS-5523 Air Filter Secondary..... A-7913 Fuel Filter..... FC-5516 Fuel Filter Secondary..... FC-5515 Fuel Filter Secondary..... FC-55151 Oil Filter Full Flow..... C-5510	
M318 (EXCAVATORS) CAT 3054 (S/N: 8AL1-UP) Air Filter Secondary..... A-7913 Air Filter Primary..... AS-5523 Fuel Filter Secondary..... FC-55151 Fuel Filter Secondary..... FC-5515 Fuel Filter..... FC-5516 Oil Filter Full Flow..... C-5510		M318C MH (MATERIAL HANDLERS) CAT 3054 (S/N: BEB1-UP) Air Filter Secondary..... A-5106 Air Filter Primary..... A-5105 Cabin Air Filter..... CA-55850 Oil Filter Full Flow..... C-5101		M318 STD (EXCAVATORS) CAT 3054 (S/N: 85S1-UP) Air Filter Primary..... AS-5523 Air Filter Secondary..... A-7913 Fuel Filter Secondary..... FC-55151 Fuel Filter Secondary..... FC-5515 Fuel Filter..... FC-5516 Oil Filter Full Flow..... C-5510	
M318 (EXCAVATORS) CAT 3116 (S/N: 6ES1-UP) Air Filter Primary..... AS-5523 Air Filter Secondary..... A-7913 Fuel Filter..... F-5505 Fuel Filter..... FC-5516 Fuel Filter Secondary..... FC-5515 Fuel Filter Secondary..... FC-55151 Oil Filter Full Flow..... C-5510		M318D (EXCAVATORS) CAT S/N: C6E1-UP Cabin Air Filter..... CA-55850 Fuel Filter..... FC-5516 Fuel Filter Secondary..... FC-55151 Fuel Filter Secondary..... FC-5515		M318 STD (EXCAVATORS) CAT 3054 (S/N: 85S1-UP) Air Filter Primary..... AS-5523 Air Filter Secondary..... A-7913 Fuel Filter Secondary..... FC-55151 Fuel Filter Secondary..... FC-5515 Fuel Filter..... FC-5516 Oil Filter Full Flow..... C-5510	
M318 (EXCAVATORS) CAT 3116 (S/N: 8AL1020-UP) Air Filter Secondary..... A-7913 Air Filter Primary..... AS-5523 Fuel Filter Secondary..... FC-55151 Fuel Filter Secondary..... FC-5515 Fuel Filter..... FC-5516 Fuel Filter..... F-5505 Oil Filter Full Flow..... C-5510		M318D (EXCAVATORS) CAT S/N: W8P1-UP Cabin Air Filter..... CA-55850 Fuel Filter Secondary..... FC-5515 Fuel Filter Secondary..... FC-55151 Fuel Filter..... FC-5516		M318 STD (EXCAVATORS) CAT 3054 (S/N: 85S1-UP) Air Filter Primary..... AS-5523 Air Filter Secondary..... A-7913 Fuel Filter Secondary..... FC-55151 Fuel Filter Secondary..... FC-5515 Fuel Filter..... FC-5516 Oil Filter Full Flow..... C-5510	
M318 (EXCAVATORS) CAT 3116 (S/N: 8AL1019-UP) Air Filter Primary..... AS-5523 Air Filter Secondary..... A-7913 Fuel Filter..... F-5505 Fuel Filter..... FC-5516 Fuel Filter Secondary..... FC-5515 Fuel Filter Secondary..... FC-55151 Oil Filter Full Flow..... C-5510		M318D (EXCAVATORS) CAT S/N: W8R1-UP Cabin Air Filter..... CA-55850 Fuel Filter..... FC-5516 Fuel Filter Secondary..... FC-55151 Fuel Filter Secondary..... FC-5515		M318 STD (EXCAVATORS) CAT 3054 (S/N: 85S1-UP) Air Filter Primary..... AS-5523 Air Filter Secondary..... A-7913 Fuel Filter Secondary..... FC-55151 Fuel Filter Secondary..... FC-5515 Fuel Filter..... FC-5516 Oil Filter Full Flow..... C-5510	
M318 (EXCAVATORS) CAT 3116 (S/N: 85S1-UP) Air Filter Secondary..... A-7913		M318D (EXCAVATORS) CAT 6.6 ACERT Fuel/Water Separator..... SFC-55240		M318 STD (EXCAVATORS) CAT 3054 (S/N: 8AL1-UP) Air Filter Primary..... AS-5523 Air Filter Secondary..... A-7913 Fuel Filter Secondary..... FC-55151 Fuel Filter Secondary..... FC-5515 Fuel Filter..... FC-5516 Oil Filter Full Flow..... C-5510	
M318 (EXCAVATORS) CAT 3116 (S/N: 85S1-UP) Air Filter Secondary..... A-7913		M318 HDU (EXCAVATORS) CAT 3054 (S/N: 8AL1-UP) Air Filter Primary..... AS-5523 Air Filter Secondary..... A-7913 Fuel Filter Secondary..... FC-55151 Fuel Filter Secondary..... FC-5515 Fuel Filter..... FC-5516 Oil Filter Full Flow..... C-5510		M322C (EXCAVATORS) CAT 3056 (S/N: BDK1-09999-UP) , 2004-UP Air Filter Primary..... A-5105 Air Filter Secondary..... A-5106 Cabin Air Filter..... CA-55850 Oil Filter Full Flow..... C-5101	
M318 (EXCAVATORS) CAT 3116 (S/N: 85S1-UP) Air Filter Secondary..... A-7913		M318 HDU (EXCAVATORS) CAT 3054 (S/N: 8AL1-UP)		M322C MH (MATERIAL HANDLERS) CAT 3056 (S/N: BDY1-UP) Air Filter Secondary..... A-5106 Air Filter Primary..... A-5105 Cabin Air Filter..... CA-55850 Oil Filter Full Flow..... C-5101	

MODEL/APPLICATION	SAKURA NO
CATERPILLAR	
M322D (EXCAVATORS) CAT S/N: C6E1-UP	
Cabin Air Filter.....	CA-55850
Fuel Filter Secondary.....	FC-5515
Fuel Filter Secondary.....	FC-55151
Fuel Filter.....	FC-5516
M322D (EXCAVATORS) CAT S/N: W2S1-UP	
Cabin Air Filter.....	CA-55850
Fuel Filter.....	FC-5516
Fuel Filter Secondary.....	FC-55151
Fuel Filter Secondary.....	FC-5515
M322D (EXCAVATORS) CAT S/N: W2T1-UP	
Cabin Air Filter.....	CA-55850
Fuel Filter Secondary.....	FC-5515
Fuel Filter Secondary.....	FC-55151
Fuel Filter.....	FC-5516
M325C (EXCAVATORS) CAT S/N: BMA1-UP	
Air Filter Primary.....	A-5558
Air Filter Secondary.....	A-5559
Cabin Air Filter.....	CA-55850
Fuel Filter.....	FC-5517
Hydraulic Oil Filter.....	H-5522
Hydraulic Oil Filter.....	H-7942
Hydraulic Oil Filter.....	HC-5801
Hydraulic Oil Filter.....	HC-55170
Oil Filter Full Flow.....	C-5522
M325C (EXCAVATORS) CAT S/N: PAN1-UP	
Air Filter Secondary.....	A-5559
Air Filter Primary.....	A-5558
Cabin Air Filter.....	CA-55850
Fuel Filter.....	FC-5517
Hydraulic Oil Filter.....	HC-55170
Hydraulic Oil Filter.....	H-5522
Hydraulic Oil Filter.....	HC-5801
Hydraulic Oil Filter.....	H-7942
Oil Filter Full Flow.....	C-5522
M325C (EXCAVATORS) CAT S/N: XJA1-UP	
Air Filter Primary.....	A-5558
Air Filter Secondary.....	A-5559
Cabin Air Filter.....	CA-55850
Fuel Filter.....	FC-5517
Hydraulic Oil Filter.....	H-5522
Hydraulic Oil Filter.....	H-7942
Hydraulic Oil Filter.....	HC-5801
Hydraulic Oil Filter.....	HC-55170
Oil Filter Full Flow.....	C-5522
M325C (EXCAVATORS) CAT 3126B ATAAC	
Hydraulic Oil Filter.....	HC-9901
M325D (EXCAVATORS) CAT (S/N: C7C1-UP)	
Fuel Filter.....	FC-5517

MODEL/APPLICATION	SAKURA NO
CATERPILLAR	
Oil Filter Full Flow.....	C-5522
M325D (EXCAVATORS) S/N: EDC1-UP	
Air Filter Primary.....	A-5558
Air Filter Secondary.....	A-5559
Cabin Air Filter.....	CA-55850
Hydraulic Oil Filter.....	HC-5801
Hydraulic Oil Filter.....	H-5522
M325D (EXCAVATORS) S/N: EDF1-UP	
Air Filter Secondary.....	A-5559
Air Filter Primary.....	A-5558
Cabin Air Filter.....	CA-55850
Hydraulic Oil Filter.....	H-5522
Hydraulic Oil Filter.....	HC-5801
M325D (EXCAVATORS) S/N: KAE1-UP	
Air Filter Primary.....	A-5558
Air Filter Secondary.....	A-5559
Cabin Air Filter.....	CA-55850
Hydraulic Oil Filter.....	HC-5801
Hydraulic Oil Filter.....	H-5522
M325D (EXCAVATORS) S/N: KAY1-UP	
Air Filter Secondary.....	A-5559
Air Filter Primary.....	A-5558
Cabin Air Filter.....	CA-55850
Hydraulic Oil Filter.....	H-5522
Hydraulic Oil Filter.....	HC-5801
M325D (EXCAVATORS) S/N: KGG1-UP	
Air Filter Primary.....	A-5558
Air Filter Secondary.....	A-5559
Cabin Air Filter.....	CA-55850
Hydraulic Oil Filter.....	HC-5801
Hydraulic Oil Filter.....	H-5522
M325D (EXCAVATORS) S/N: KGG212-UP	
Air Filter Secondary.....	A-5559
Air Filter Primary.....	A-5558
Cabin Air Filter.....	CA-55850
Hydraulic Oil Filter.....	H-5522
Hydraulic Oil Filter.....	HC-5801
M325B MH (MATERIAL HANDLERS) CAT 3056 (S/N: BGN1-UP)	
Air Filter Secondary.....	A-8507
Air Filter Set.....	A-8604-S
Air Filter Set.....	A-8508M-S
Air Filter Primary.....	A-8508
Air Filter Primary.....	A-8508M
Cabin Air Filter.....	CA-55850
Fuel Filter.....	FC-5516
Fuel Filter Secondary.....	FC-55151
Fuel Filter Secondary.....	FC-5515
Fuel Filter.....	FC-5508
Hydraulic Oil Filter.....	HC-5801
Hydraulic Oil Filter.....	H-7942
Hydraulic Oil Filter.....	HC-5505

MODEL/APPLICATION	SAKURA NO
CATERPILLAR	
Oil Filter Full Flow.....	C-5510
M330D (EXCAVATORS) CAT S/N: MBR1-UP	
Cabin Air Filter.....	CA-55850
M330D (EXCAVATORS) CAT S/N: THY1-UP	
Cabin Air Filter.....	CA-55850
(ENGINES) CAT C1.1 (S/N: C7Y1-UP) , 1100, 2011	
Air Filter Secondary.....	A-55980
Air Filter Primary.....	A-5597
Air Filter Set.....	A-5597-S
Oil Filter Full Flow.....	C-1123
(ENGINES) CAT C1.1 (S/N: G8M1-UP) , 1100, 2011	
Air Filter Set.....	A-5597-S
Air Filter Primary.....	A-5597
Air Filter Secondary.....	A-55980
Oil Filter Full Flow.....	C-1123
(ENGINES) CAT C1.1 (S/N: G8N1-UP) , 1100, 2011	
Air Filter Secondary.....	A-55980
Air Filter Primary.....	A-5597
Air Filter Set.....	A-5597-S
Oil Filter Full Flow.....	C-1123
(ENGINES) CAT C1.1 (S/N: C3M1-UP) , 1100, 2011	
Air Filter Primary.....	A-5597
Air Filter Set.....	A-5597-S
Air Filter Secondary.....	A-55980
Oil Filter Full Flow.....	C-1123
(ENGINES) CAT C1.1 (S/N: C6L1-UP) , 1100, 2011	
Air Filter Secondary.....	A-55980
Air Filter Set.....	A-5597-S
Air Filter Primary.....	A-5597
Oil Filter Full Flow.....	C-1123
(MARINE) CAT C1.5 (S/N: C5N1-UP) , 1500	
Air Filter Primary.....	A-5597
Air Filter Set.....	A-5597-S
Air Filter Secondary.....	A-55980
Oil Filter Full Flow.....	C-1123
(MARINE) CAT C1.5 (S/N: C6N1-UP) , 1500	
Air Filter Secondary.....	A-55980
Air Filter Set.....	A-5597-S
Air Filter Primary.....	A-5597
Oil Filter Full Flow.....	C-1123
(MARINE) CAT C1.5 (S/N: C8W1-UP) , 1500	
Air Filter Primary.....	A-5597
Air Filter Set.....	A-5597-S
Air Filter Secondary.....	A-55980
Oil Filter Full Flow.....	C-1123

MODEL/APPLICATION	SAKURA NO
CATERPILLAR	
<i>(MARINE)</i>	
CAT C1.5 (S/N: G7N1-UP) , 1500	
Air Filter Secondary.....	A-55980
Air Filter Set.....	A-5597-S
Air Filter Primary.....	A-5597
Oil Filter Full Flow.....	C-1123
<i>(MARINE)</i>	
CAT C1.5 (S/N: G7P1-UP) , 1500	
Air Filter Primary.....	A-5597
Air Filter Set.....	A-5597-S
Air Filter Secondary.....	A-55980
Oil Filter Full Flow.....	C-1123
<i>(MARINE)</i>	
CAT C1.5 (S/N: NCA1-UP) , 1500	
Air Filter Secondary.....	A-55980
Air Filter Set.....	A-5597-S
Air Filter Primary.....	A-5597
<i>(MARINE)</i>	
CAT C1.5 (S/N: TAF1-UP) , 1500	
Air Filter Primary.....	A-5597
Air Filter Set.....	A-5597-S
Air Filter Secondary.....	A-55980
<i>(ENGINES)</i>	
CAT C4.4 , 4400	
Air Filter Secondary.....	A-5148
<i>(ENGINES)</i>	
CAT C12 (S/N: 2KS1-UP) , 2011	
Coolant Filter.....	WC-6901
Coolant Filter.....	WC-5705
Coolant Filter.....	WC-5707
Fuel Filter.....	FC-5509
Fuel/Water Separator.....	SF-5704
Fuel/Water Separator.....	SFC-5505
Fuel/Water Separator Secondary..	SFC-5504-10B
Fuel/Water Separator Secondary..	SFC-5504-10B
Oil Filter By Pass.....	C-5718
<i>(ENGINES)</i>	
CAT C12 (S/N: 9NS1-UP) , 2011	
Coolant Filter.....	WC-5707
Coolant Filter.....	WC-5705
Coolant Filter.....	WC-6901
Fuel Filter.....	FC-5509
Fuel/Water Separator Secondary..	SFC-5504-10B
Fuel/Water Separator Secondary..	SFC-5504-10B
Fuel/Water Separator.....	SFC-5505
Fuel/Water Separator.....	SF-5704
Oil Filter By Pass.....	C-5718
Oil Filter Full Flow.....	C-5516
<i>(ENGINES)</i>	
CAT C12 (S/N: 9SM1-UP) , 2011	
Fuel Filter.....	FC-5509
Fuel/Water Separator.....	SFC-5505
Oil Filter Full Flow.....	C-5516
<i>(ENGINES)</i>	
CAT 3011C (S/N: 3111-UP) , 2011	
Air Filter Secondary.....	A-55980
Air Filter Set.....	A-5597-S

MODEL/APPLICATION	SAKURA NO
CATERPILLAR	
Air Filter Primary.....	A-5597
Fuel/Water Separator.....	SFC-43040
Oil Filter Full Flow.....	C-1123
<i>(ENGINES)</i>	
CAT 3011C (S/N: G1P1-UP) , 2011	
Air Filter Primary.....	A-5597
Air Filter Set.....	A-5597-S
Air Filter Secondary.....	A-55980
Fuel/Water Separator.....	SFC-43040
Oil Filter Full Flow.....	C-1123
<i>(ENGINES)</i>	
CAT 3013C (S/N: 3131-599) , 2011	
Air Filter Secondary.....	A-55980
Air Filter Set.....	A-5597-S
Air Filter Primary.....	A-5597
Oil Filter Full Flow.....	C-1123
<i>(ENGINES)</i>	
CAT 3013C (S/N: 313600-UP) , 2011	
Air Filter Primary.....	A-5597
Air Filter Set.....	A-5597-S
Air Filter Secondary.....	A-55980
Oil Filter Full Flow.....	C-1123
<i>(ENGINES)</i>	
CAT 3013C (S/N: G3P1-UP) , 2011	
Air Filter Secondary.....	A-55980
Air Filter Set.....	A-5597-S
Air Filter Primary.....	A-5597
Oil Filter Full Flow.....	C-1123
<i>(ENGINES)</i>	
CAT 3516 EUI , 2008-UP	
Oil Filter Full Flow.....	O-5504
<i>(ENGINES)</i>	
CAT 3116	
Air Filter.....	A-5596
Air Filter Secondary.....	A-5567
Air Filter Primary.....	A-5566
Air Filter Set.....	A-5568-S
Coolant Filter.....	WC-5707
Fuel Filter Secondary.....	FC-5507
Fuel Filter Secondary.....	FC-5515
Fuel Filter Secondary.....	FC-55151
Fuel Filter.....	FC-5516
Fuel/Water Separator.....	SF-5704
Oil Filter Full Flow.....	C-5522
Oil Filter Full Flow.....	C-5505
Oil Filter Full Flow.....	C-5510
<i>(ENGINES)</i>	
CAT 3126	
Fuel Filter.....	FC-5516
Fuel Filter Secondary.....	FC-55151
Fuel Filter Secondary.....	FC-5515
Fuel/Water Separator.....	SF-5704
Fuel/Water Separator.....	SFC-5505
Fuel/Water Separator.....	SFC-5709-10
Oil Filter Full Flow.....	C-5510
Oil Filter Full Flow.....	C-5522
Oil Filter Full Flow.....	C-55221

MODEL/APPLICATION	SAKURA NO
CATERPILLAR	
<i>(ENGINES)</i>	
CAT 3126B	
Fuel Filter Secondary.....	FC-5515
Fuel Filter Secondary.....	FC-55151
Fuel Filter.....	FC-5516
Fuel/Water Separator.....	SFC-5709-10
Fuel/Water Separator.....	SFC-5505
Oil Filter Full Flow.....	C-55221
Oil Filter Full Flow.....	C-5522
Oil Filter Full Flow.....	C-5510
<i>(ENGINES)</i>	
CAT 3150	
Air Filter.....	AS-5002
Fuel Filter.....	FC-5503
Oil Filter Full Flow.....	C-5504
<i>(ENGINES)</i>	
CAT 3176	
Air Filter Secondary.....	A-5522
Air Filter Primary.....	A-5509
Air Filter Set.....	A-5522-S
Coolant Filter.....	WC-5708
Fuel Filter.....	FC-5501
Fuel Filter.....	F-5505
Fuel Filter.....	FC-5509
Fuel Filter.....	FC-5519
Fuel Filter Secondary.....	FC-5507
Fuel/Water Separator.....	SF-5704
Oil Filter Full Flow.....	C-5516
Oil Filter Full Flow.....	C-5505
Oil Filter Full Flow.....	C-5519
<i>(ENGINES)</i>	
CAT 3176C	
Air Filter Secondary.....	A-5556
Air Filter Primary.....	A-5555
Air Filter Set.....	A-5555-S
Fuel/Water Separator.....	SF-5704
Fuel/Water Separator Secondary..	SFC-5504-10B
Fuel/Water Separator Secondary..	SFC-5504-10B
Oil Filter Full Flow.....	C-5516
<i>(ENGINES)</i>	
CAT 3208	
Air Filter Secondary.....	A-5550
Air Filter Set.....	A-5549M-S
Air Filter Primary.....	A-5549M
Air Filter.....	AS-5002
Air Filter Primary.....	A-5549
Air Filter.....	A-5553
Air Filter Secondary.....	A-5522
Air Filter Set.....	A-5522-S
Air Filter Primary.....	A-5509
Fuel Filter Secondary.....	FC-5507
Fuel Filter.....	F-5505
Fuel Filter.....	FC-5501
Fuel/Water Separator.....	SF-5704
Oil Filter Full Flow.....	C-5519
Oil Filter Full Flow.....	C-5504
Oil Filter Full Flow.....	C-5505

Sakura Filter

ENGINE APPLICATION

MODEL/APPLICATION	SAKURA NO
-------------------	-----------

CATERPILLAR

(ENGINES)
CAT 3304

Air Filter Primary.....	A-5509
Air Filter Set.....	A-5522-S
Air Filter.....	A-5506
Air Filter.....	A-5504
Air Filter.....	A-5505
Air Filter Secondary.....	A-5508
Air Filter Secondary.....	A-5522
Air Filter Secondary.....	A-5510
Air Filter Primary.....	A-5549
Air Filter Primary.....	A-5549M
Air Filter Set.....	A-5549M-S
Air Filter Secondary.....	A-5550
Air Filter Set.....	A-55071-S
Air Filter Set.....	A-5507-S
Air Filter Primary.....	A-5507
Coolant Filter.....	WC-5707
Coolant Filter.....	WC-5705
Coolant Filter.....	WC-5708
Fuel Filter Secondary.....	FC-5507
Fuel Filter.....	FC-5501
Fuel/Water Separator.....	SF-5704
Oil Filter Full Flow.....	C-5516
Oil Filter Full Flow.....	C-5510

(ENGINES)
CAT 3306

Air Filter Primary.....	A-5507
Air Filter Secondary.....	A-5520
Air Filter Set.....	A-5507-S
Air Filter Set.....	A-55071-S
Air Filter Set.....	A-5544-S
Air Filter Primary.....	A-5543
Air Filter Secondary.....	A-5510
Air Filter Secondary.....	A-5508
Air Filter.....	A-5505
Air Filter.....	A-5504
Air Filter Set.....	A-5522-S
Air Filter Primary.....	A-5509
Fuel Filter.....	FC-5501
Fuel Filter Secondary.....	FC-5507
Fuel Filter.....	F-5505
Fuel Filter.....	FC-5509
Fuel/Water Separator.....	SF-5704
Oil Filter Full Flow.....	O-5501
Oil Filter Full Flow.....	C-5522
Oil Filter Full Flow.....	C-5510
Oil Filter Full Flow.....	C-5516

(ENGINES)
CAT 3406

Air Filter Secondary.....	A-5417
Air Filter.....	A-5506
Air Filter Secondary.....	A-5715
Air Filter Secondary.....	A-5552
Air Filter Set.....	A-7912-S
Air Filter Secondary.....	A-7915
Air Filter Primary.....	A-7912
Air Filter Primary.....	A-5501
Air Filter Secondary.....	A-5502

MODEL/APPLICATION	SAKURA NO
-------------------	-----------

CATERPILLAR

Air Filter Primary.....	A-5425
Air Filter.....	A-5513
Air Filter Set.....	A-5521-S
Air Filter Primary.....	A-5521
Air Filter Secondary.....	A-5529
Coolant Filter.....	WC-5705
Coolant Filter.....	WC-5707
Fuel Filter.....	FC-5509
Fuel Filter.....	F-5505
Fuel Filter.....	FC-5519
Fuel Filter.....	FC-5502
Fuel/Water Separator.....	SF-5704
Hydraulic Oil Filter.....	H-5505
Hydraulic Oil Filter.....	HC-55200
Oil Filter Full Flow.....	O-5501
Oil Filter Full Flow.....	C-5516

(ENGINES)
CAT 3406C

Air Filter.....	A-5506
Coolant Filter.....	WC-5705
Fuel Filter.....	FC-5519
Fuel Filter.....	F-5505
Fuel Filter.....	F-5506
Fuel Filter.....	FC-5509
Oil Filter Full Flow.....	C-5516
Oil Filter Full Flow.....	O-5501

(ENGINES)
CAT 3406E

Coolant Filter.....	WC-5705
Fuel Filter.....	FC-5509
Fuel Filter.....	F-5505
Fuel Filter.....	FC-5519
Fuel/Water Separator.....	SFC-5505
Oil Filter Full Flow.....	C-5516

(ENGINES)
CAT 3408

Air Filter Secondary.....	A-5529
Air Filter.....	A-5517
Air Filter Primary.....	A-5521
Air Filter Set.....	A-5521-S
Air Filter.....	A-5513
Air Filter Primary.....	A-7912
Air Filter Set.....	A-7912-S
Air Filter Secondary.....	A-5552
Air Filter Set.....	A-5532-S
Air Filter Primary.....	A-5532
Coolant Filter.....	WC-5705
Fuel Filter.....	FC-5502
Fuel Filter.....	FC-5519
Fuel Filter.....	F-5505
Fuel Filter.....	FC-5509
Fuel/Water Separator.....	SF-5704
Oil Filter Full Flow.....	O-5501
Oil Filter Full Flow.....	C-5516

(ENGINES)
CAT 3412

Air Filter Secondary.....	A-5556
Air Filter Secondary.....	A-5552
Air Filter Primary.....	A-5555

MODEL/APPLICATION	SAKURA NO
-------------------	-----------

CATERPILLAR

Air Filter Set.....	A-5555-S
Air Filter.....	A-5513
Air Filter Set.....	A-5521-S
Air Filter Primary.....	A-5521
Coolant Filter.....	WC-5705
Fuel Filter.....	FC-5509
Fuel Filter.....	FC-5519
Fuel/Water Separator.....	SF-5704
Oil Filter Full Flow.....	O-5501
Oil Filter Full Flow.....	C-5516

(ENGINES)
CAT 3508B

Air Filter Primary.....	A-5531
Air Filter Set.....	A-5531-S
Air Filter Secondary.....	A-5533
Fuel Filter.....	F-5504
Fuel Filter.....	FC-5510
Fuel Filter.....	FC-5506
Oil Filter Full Flow.....	O-5504
Oil Filter Full Flow.....	C-5516

(ENGINES)
CAT C11

Fuel Filter.....	FC-5517
Fuel Filter.....	FC-5519
Fuel Filter.....	FC-5509
Oil Filter Full Flow.....	C-5516

(ENGINES)
CAT C12

Fuel Filter.....	FC-5509
Fuel Filter.....	F-5505
Fuel Filter.....	FC-5519
Fuel/Water Separator.....	SF-5704
Fuel/Water Separator Secondary..	SFC-5504-10
Fuel/Water Separator Secondary..	SFC-5504-10B
Oil Filter Full Flow.....	C-5516

(ENGINES)
CAT C15

Fuel Filter.....	FC-5519
Fuel Filter.....	F-5505
Fuel Filter.....	FC-5509
Fuel/Water Separator Secondary..	SFC-5504-10B
Fuel/Water Separator Secondary..	SFC-5504-10
Oil Filter Full Flow.....	C-5516

(ENGINES)
CAT C9

Fuel Filter.....	FC-5516
Fuel Filter Secondary.....	FC-55151
Fuel Filter Secondary.....	FC-5515
Fuel/Water Separator Secondary..	SFC-5504-10
Fuel/Water Separator.....	SFC-5505
Fuel/Water Separator Secondary..	SFC-5504-10B
Fuel/Water Separator.....	SFC-5709-10
Oil Filter Full Flow.....	C-5522
Oil Filter Full Flow.....	C-55221
Oil Filter Full Flow.....	C-5516

(ENGINES)
CAT D337

Fuel Filter.....	F-5501
Oil Filter Full Flow.....	O-5505

Sakura Filter

ENGINE APPLICATION

MODEL/APPLICATION	SAKURA NO	MODEL/APPLICATION	SAKURA NO	MODEL/APPLICATION	SAKURA NO
CATERPILLAR		CATERPILLAR		CATERPILLAR	
(ENGINES) CAT D337		(ENGINES) CAT 3412E		(ENGINES) CAT 3306C	
Oil Filter Full Flow.....	0-5503	Fuel Filter.....	FC-5509	Fuel Filter.....	FC-5501
Oil Filter Full Flow.....	0-5502	Fuel Filter.....	FC-5509	Fuel/Water Separator.....	SF-5704
(ENGINES) CAT D-375		(ENGINES) CAT C16		Oil Filter Full Flow.....	0-5501
Oil Filter Full Flow.....	0-7902	Fuel Filter.....	FC-5509	Oil Filter Full Flow.....	C-5522
(ENGINES) CAT D-397		Fuel Filter.....	F-5505	Oil Filter Full Flow.....	C-5510
Oil Filter Full Flow.....	0-7902	Fuel Filter.....	FC-5519	Oil Filter Full Flow.....	C-5516
(ENGINES) CAT C10		Fuel/Water Separator Secondary... SFC-5504-10B		(ENGINES) CAT 3306C	
Fuel Filter.....	FC-5519	Fuel/Water Separator Secondary.. SFC-5504-10B		Air Filter Set.....	A-5549M-S
Fuel Filter.....	FC-5509	Fuel/Water Separator.....	SF-5704	Air Filter Primary.....	A-5549M
Fuel Filter.....	F-5505	Oil Filter Full Flow.....	C-5516	Air Filter Primary.....	A-5549
Fuel/Water Separator Secondary.. SFC-5504-10B		(ENGINES) CAT 3176B		Air Filter Primary.....	A-5509
Fuel/Water Separator Secondary.. SFC-5504-10		Fuel Filter.....	FC-5519	Air Filter Set.....	A-5522-S
Fuel/Water Separator.....	SF-5704	Fuel Filter.....	F-5505	Fuel Filter.....	F-5505
Oil Filter Full Flow.....	C-5516	Fuel Filter.....	FC-5509	Fuel Filter Secondary.....	FC-5507
(ENGINES) CAT C13		Fuel/Water Separator.....	SF-5704	Fuel/Water Separator.....	SF-5704
Fuel Filter.....	FC-5509	Oil Filter Full Flow.....	C-5516	Fuel/Water Separator.....	SFC-5705
Fuel Filter.....	FC-5519	(ENGINES) CAT 3304B		Oil Filter Full Flow.....	C-5516
Oil Filter Full Flow.....	C-5516	Air Filter Primary.....	A-5507	Oil Filter Full Flow.....	C-5522
Oil Filter Full Flow.....	C-7906	Air Filter Set.....	A-5507-S	Oil Filter Full Flow.....	C-5510
(ENGINES) CAT C7		Air Filter Primary.....	A-5549	(ENGINES) CAT 3400	
Fuel Filter Secondary.....	FC-55151	Air Filter Secondary.....	A-5550	Coolant Filter.....	WC-5708
Fuel Filter.....	FC-5516	Air Filter Set.....	A-5549M-S	Fuel Filter Secondary.....	FC-5515
Fuel Filter Secondary.....	FC-5515	Air Filter Primary.....	A-5530	Fuel Filter.....	FC-5519
Fuel/Water Separator.....	SFC-5505	Air Filter Secondary.....	A-5510	Fuel Filter.....	FC-5516
Fuel/Water Separator.....	SFC-5709-10	Air Filter Secondary.....	A-5522	Fuel Filter Secondary.....	FC-55151
Oil Filter Full Flow.....	C-55221	Air Filter.....	A-5506	Fuel Filter.....	FC-5509
Oil Filter Full Flow.....	C-5522	Air Filter Secondary.....	A-5508	Oil Filter Full Flow.....	C-5516
Oil Filter Full Flow.....	C-5516	Air Filter.....	A-5504	Oil Filter Full Flow.....	C-5516
Oil Filter Full Flow.....	C-5510	Air Filter Primary.....	A-5509	(ENGINES) CAT 3406B	
(ENGINES) CAT 3054		Air Filter Set.....	A-5522-S	Air Filter Secondary.....	A-5417
Fuel Filter.....	FC-5103	Fuel Filter Secondary.....	FC-5507	Air Filter.....	A-5506
Oil Filter Full Flow.....	C-5101	Fuel Filter.....	FC-5501	Air Filter Set.....	A-7912-S
Oil Filter Full Flow.....	C-5102	Fuel/Water Separator.....	SF-5704	Air Filter Primary.....	A-7912
(ENGINES) CAT 3196		Oil Filter Full Flow.....	C-5516	Air Filter Secondary.....	A-7915
Fuel Filter.....	FC-5509	(ENGINES) CAT 3306B		Air Filter Secondary.....	A-5552
Fuel/Water Separator Secondary.. SFC-5504-10B		Air Filter Set.....	A-5522-S	Air Filter Primary.....	A-5425
Fuel/Water Separator Secondary.. SFC-5504-10		Air Filter Primary.....	A-5509	Air Filter.....	A-5513
Fuel/Water Separator.....	SF-5704	Air Filter.....	A-5504	Air Filter Secondary.....	A-5502
Oil Filter Full Flow.....	C-5516	Air Filter Secondary.....	A-5508	Air Filter Primary.....	A-5501
(ENGINES) CAT 3412C		Air Filter.....	A-5505	Air Filter Set.....	A-5521-S
Air Filter Secondary.....	A-5556	Air Filter Secondary.....	A-5510	Air Filter Primary.....	A-5521
Air Filter Set.....	A-5555-S	Air Filter Primary.....	A-5543	Air Filter Secondary.....	A-5529
Air Filter Primary.....	A-5555	Air Filter Set.....	A-5544-S	Coolant Filter.....	WC-5705
Air Filter.....	AH-5502	Air Filter Set.....	A-55071-S	Fuel Filter.....	FC-5509
Air Filter Primary.....	A-5521	Air Filter Set.....	A-5507-S	Fuel Filter.....	F-5505
Air Filter Set.....	A-5521-S	Air Filter Primary.....	A-5507	Fuel Filter.....	FC-5519
Air Filter.....	A-5513	Air Filter Secondary.....	A-5520	Oil Filter Full Flow.....	C-5516
(ENGINES) CAT 3306B		Fuel Filter Secondary.....	FC-5507	(ENGINES) CAT 3408B	
Fuel Filter.....	FC-5509	Fuel Filter.....	FC-5509	Air Filter Secondary.....	A-5529
Fuel Filter.....	F-5505	Fuel Filter.....	F-5505	Air Filter.....	A-5517
Fuel Filter.....	FC-5519	Fuel Filter.....	FC-5509	Air Filter Primary.....	A-5521
Oil Filter Full Flow.....	C-5516	Fuel Filter.....	F-5505	Air Filter Set.....	A-5521-S
(ENGINES) CAT 3408B		Fuel Filter.....	FC-5509	Air Filter.....	A-5513
Air Filter Secondary.....	A-5529	Fuel Filter.....	F-5505	Air Filter Secondary.....	A-5552
Air Filter.....	A-5517	Fuel Filter.....	FC-5509	Air Filter Set.....	A-5532-S
Air Filter Primary.....	A-5521	Fuel Filter.....	F-5505	Air Filter Primary.....	A-5532
Air Filter Set.....	A-5521-S	(ENGINES) CAT 3306B		(ENGINES) CAT 3408B	
Air Filter.....	A-5513	Air Filter Set.....	A-5522-S	Air Filter Secondary.....	A-5529
Air Filter Secondary.....	A-5552	Air Filter Primary.....	A-5507	Air Filter.....	A-5517
Air Filter Set.....	A-5532-S	Air Filter Secondary.....	A-5520	Air Filter Primary.....	A-5521
Air Filter Primary.....	A-5532	Fuel Filter Secondary.....	FC-5507	Air Filter Set.....	A-5521-S
(ENGINES) CAT 3408B		Fuel Filter.....	FC-5509	Air Filter.....	A-5513
Air Filter Secondary.....	A-5529	Fuel Filter.....	F-5505	Air Filter Secondary.....	A-5552
Air Filter.....	A-5517	Fuel Filter.....	FC-5509	Air Filter Set.....	A-5532-S
Air Filter Primary.....	A-5521	Fuel Filter.....	F-5505	Air Filter Primary.....	A-5532
Air Filter Set.....	A-5521-S	(ENGINES) CAT 3306B		(ENGINES) CAT 3408B	
Air Filter.....	A-5513	Air Filter Set.....	A-5522-S	Air Filter Secondary.....	A-5529
Air Filter Secondary.....	A-5552	Air Filter Primary.....	A-5507	Air Filter.....	A-5517
Air Filter Set.....	A-5532-S	Air Filter Secondary.....	A-5520	Air Filter Primary.....	A-5521
Air Filter Primary.....	A-5532	Fuel Filter Secondary.....	FC-5507	Air Filter Set.....	A-5521-S
(ENGINES) CAT 3408B		Fuel Filter.....	FC-5509	Air Filter.....	A-5513
Air Filter Secondary.....	A-5529	Fuel Filter.....	F-5505	Air Filter Secondary.....	A-5552
Air Filter.....	A-5517	Fuel Filter.....	FC-5509	Air Filter Set.....	A-5532-S
Air Filter Primary.....	A-5521	Fuel Filter.....	F-5505	Air Filter Primary.....	A-5532

MODEL/APPLICATION	SAKURA NO	MODEL/APPLICATION	SAKURA NO	MODEL/APPLICATION	SAKURA NO
CATERPILLAR		CATERPILLAR		CATERPILLAR	
(ENGINES) CAT 3408B		Air Filter Set.....	A-5531-S	Fuel Filter Secondary.....	FC-55151
Air Filter Secondary.....	A-7915	Fuel Filter.....	FC-5506	Fuel/Water Separator.....	SFC-5709-10
Air Filter Primary.....	A-7912	Fuel Filter.....	FC-5509	Fuel/Water Separator.....	SFC-5505
Air Filter Set.....	A-7912-S	Fuel Filter.....	FC-5510	Oil Filter Full Flow.....	C-5510
Coolant Filter.....	WC-5705	Fuel Filter.....	F-5504	Oil Filter Full Flow.....	C-5522
Fuel Filter.....	FC-5502	Oil Filter Full Flow.....	C-5516	Oil Filter Full Flow.....	C-55221
Fuel Filter.....	FC-5519	Oil Filter Full Flow.....	0-5504		
Fuel Filter.....	F-5505	(ENGINES)		(ENGINES)	
Fuel Filter.....	FC-5509	CAT 3516B		CAT 3054E	
Oil Filter Full Flow.....	C-5516	Air Filter.....	A-44250	Air Filter Secondary.....	A-5148
		Air Filter Set.....	A-5531-S		
(ENGINES)		Air Filter Primary.....	A-5531	(ENGINES)	
CAT 3408C		Air Filter Set.....	A-5551-S	CAT C4.4	
Air Filter Set.....	A-7912-S	Air Filter Primary.....	A-5588	Air Filter Primary.....	A-7003
Air Filter Primary.....	A-7912	Air Filter.....	A-5551	Air Filter Primary.....	A-76231
Air Filter Secondary.....	A-7915	Air Filter Secondary.....	A-5533	Air Filter Primary.....	A-5541
Air Filter Primary.....	A-5532	Fuel Filter.....	F-5504	Air Filter Primary.....	A-5541M
Air Filter Set.....	A-5532-S	Fuel Filter.....	FC-5510	Air Filter Set.....	A-5541M-S
Air Filter Secondary.....	A-5552	Fuel Filter.....	FC-5506	Oil Filter Full Flow.....	C-5102
Air Filter.....	A-5513	Oil Filter Full Flow.....	C-5516		
Air Filter Set.....	A-5521-S	Oil Filter Full Flow.....	0-5504	(ENGINES)	
Air Filter Primary.....	A-5521	(ENGINES)		CAT (S/N: 23B1-23B299)	
Air Filter Secondary.....	A-5529	CAT C32 ACERT		Oil Filter Full Flow.....	0-5503
Coolant Filter.....	WC-5705	Fuel Filter.....	FC-5510	Oil Filter Full Flow.....	0-5502
Fuel Filter.....	FC-5509	Oil Filter Full Flow.....	C-5516		
Fuel Filter.....	FC-5519	(ENGINES)		(ENGINES)	
Oil Filter Full Flow.....	C-5516	CAT D324C		CAT (S/N: 23B300-UP)	
		Oil Filter Full Flow.....	0-5502	Air Filter.....	A-5596
(ENGINES)		(ENGINES)		Coolant Filter.....	WC-5707
CAT 3500		CAT D333A		Fuel Filter Secondary.....	FC-55151
Coolant Filter.....	WC-5708	Oil Filter Full Flow.....	0-5502	Fuel Filter.....	FC-5516
Fuel Filter.....	FC-5510	(ENGINES)		Fuel Filter Secondary.....	FC-5515
Fuel Filter.....	FC-5519	CAT D379B		Fuel Filter.....	F-6505
Fuel Filter Secondary.....	FC-55151	Air Filter.....	A-5518	Oil Filter Full Flow.....	0-5503
Fuel Filter.....	FC-5516	Fuel Filter.....	F-5501		
Fuel Filter Secondary.....	FC-5515	Oil Filter Full Flow.....	0-5503	(ENGINES)	
Fuel Filter.....	FC-5506	(ENGINES)		CAT (S/N: 23C740-UP)	
Oil Filter Full Flow.....	C-5516	CAT D398B		Air Filter.....	A-5596
		Air Filter.....	A-5518	Air Filter Primary.....	A-5509
(ENGINES)		Fuel Filter.....	F-5501	Air Filter Set.....	A-5522-S
CAT 3512		Oil Filter Full Flow.....	0-5503	Coolant Filter.....	WC-5707
Air Filter Primary.....	A-5521	(ENGINES)		Fuel Filter Secondary.....	FC-5515
Air Filter Set.....	A-5521-S	CAT 3160		Fuel Filter.....	FC-5516
Air Filter Set.....	A-5531-S	Air Filter.....	AS-5002	Fuel Filter Secondary.....	FC-55151
Air Filter Primary.....	A-5531	Fuel Filter.....	FC-5503	Fuel/Water Separator.....	SF-5704
Air Filter Secondary.....	A-5552	Oil Filter Full Flow.....	C-5504	Oil Filter Full Flow.....	C-5510
Air Filter Secondary.....	A-5533	(ENGINES)		Oil Filter Full Flow.....	C-5516
Air Filter.....	A-44250	CAT 3208N			
Fuel Filter.....	FC-5506	Air Filter Set.....	A-5522-S	(ENGINES)	
Fuel Filter.....	F-5504	Air Filter Primary.....	A-5509	CAT (S/N: 24B1-24B20)	
Fuel Filter.....	FC-5510	Fuel/Water Separator.....	SF-5704	Oil Filter Full Flow.....	0-5503
Fuel/Water Separator Final.....	SF-1912-2	Oil Filter Full Flow.....	C-5510	Oil Filter Full Flow.....	0-5502
Oil Filter Full Flow.....	C-5516	Oil Filter Full Flow.....	C-5516		
Oil Filter Full Flow.....	0-5504	(ENGINES)		(ENGINES)	
		CAT 3208N		CAT (S/N: 24B21-UP)	
(ENGINES)		Air Filter Set.....	A-5522-S	Air Filter.....	A-5596
CAT 3512B		Air Filter Primary.....	A-5509	Coolant Filter.....	WC-5707
Air Filter Secondary.....	A-5533	Fuel/Water Separator.....	SF-5704	Fuel Filter Secondary.....	FC-55151
Air Filter.....	A-5551	Oil Filter Full Flow.....	C-5510	Fuel Filter.....	FC-5516
Air Filter Primary.....	A-5588	Oil Filter Full Flow.....	C-5516	Fuel Filter Secondary.....	FC-5515
Air Filter Set.....	A-5551-S	(ENGINES)		Fuel Filter.....	F-6505
Air Filter Primary.....	A-5531	CAT 3126E		Oil Filter Full Flow.....	0-5503
		Fuel Filter Secondary.....	FC-5515		
		Fuel Filter.....	FC-5516	(ENGINES)	
				CAT (S/N: 24Z1-UP)	
				Air Filter Secondary.....	A-5533

Sakura Filter

ENGINE APPLICATION

MODEL/APPLICATION	SAKURA NO	MODEL/APPLICATION	SAKURA NO	MODEL/APPLICATION	SAKURA NO
CATERPILLAR		CATERPILLAR		CATERPILLAR	
<i>(ENGINES)</i> CAT (S/N: 24Z1-UP)					
Air Filter Primary.....	A-5531	Oil Filter Full Flow.....	0-5503	Fuel Filter.....	F-5505
Air Filter Set.....	A-5531-S	Oil Filter Full Flow.....	0-5502	Fuel Filter.....	FC-5501
Fuel Filter.....	F-5504	<i>(ENGINES)</i> CAT 1140		Oil Filter Full Flow.....	0-5503
Oil Filter Full Flow.....	C-5516	Fuel Filter.....	FC-5503	<i>(ENGINES)</i> CAT 1693	
Oil Filter Full Flow.....	0-5504	Oil Filter Full Flow.....	C-5504	Air Filter.....	A-5596
<i>(ENGINES)</i> CAT (S/N: 26B1-26B35)		<i>(ENGINES)</i> CAT 1145		Air Filter.....	A-6702
Oil Filter Full Flow.....	0-5503	Fuel Filter.....	FC-5503	Air Filter.....	A-5506
<i>(ENGINES)</i> CAT (S/N: 26B36-UP)		Oil Filter Full Flow.....	C-5504	Fuel Filter.....	F-5505
Fuel Filter.....	F-6505	<i>(ENGINES)</i> CAT 1150		Fuel Filter.....	F-5501
Oil Filter Full Flow.....	0-5503	Fuel Filter.....	FC-5503	Fuel Filter.....	FC-5501
<i>(ENGINES)</i> CAT (S/N: 27B1-27B16)		Oil Filter Full Flow.....	C-5504	Oil Filter Full Flow.....	0-5503
Oil Filter Full Flow.....	0-5503	<i>(ENGINES)</i> CAT 1160		<i>(ENGINES)</i> CAT 205B (S/N: 5ZF1-UP)	
<i>(ENGINES)</i> CAT (S/N: 27B17-UP)		Fuel Filter.....	FC-5503	Fuel Filter Secondary.....	FC-5507
Fuel Filter.....	F-6505	Oil Filter Full Flow.....	C-5504	<i>(ENGINES)</i> CAT 206B (S/N: 9BF1-UP)	
Oil Filter Full Flow.....	0-5503	<i>(ENGINES)</i> CAT 1670		Fuel Filter Secondary.....	FC-5507
<i>(ENGINES)</i> CAT (S/N: 32B1198-32B1539)		Air Filter Set.....	A-5522-S	<i>(ENGINES)</i> CAT 211B (S/N: 6XG1-UP)	
Fuel Filter.....	F-5501	Air Filter Primary.....	A-5509	Fuel Filter Secondary.....	FC-5507
Oil Filter Full Flow.....	0-5501	Fuel Filter.....	F-5501	<i>(ENGINES)</i> CAT 212B (S/N: 3PJ1-UP)	
<i>(ENGINES)</i> CAT (S/N: 32B1-32B1197)		Oil Filter Full Flow.....	0-5503	Fuel Filter Secondary.....	FC-5507
Air Filter.....	A-5596	<i>(ENGINES)</i> CAT 1673		<i>(ENGINES)</i> CAT 2516	
Coolant Filter.....	WC-5707	Air Filter Primary.....	A-5509	Air Filter Secondary.....	A-5533
Fuel Filter.....	F-5501	Air Filter Set.....	A-5522-S	Air Filter Set.....	A-5531-S
Fuel Filter Secondary.....	FC-5515	Fuel Filter.....	F-5501	Air Filter Primary.....	A-5531
Fuel Filter.....	FC-5516	Fuel Filter.....	F-5505	Fuel Filter.....	F-5504
Fuel Filter Secondary.....	FC-55151	Oil Filter Full Flow.....	0-5503	Fuel Filter.....	FC-5506
Oil Filter Full Flow.....	0-5501	Oil Filter Full Flow.....	0-5501	<i>(ENGINES)</i> CAT 3054T (S/N: 42K4648-42K4648)	
<i>(ENGINES)</i> CAT (S/N: 32B1540-UP)		<i>(ENGINES)</i> CAT 1673B		Air Filter Primary.....	A-76231
Fuel Filter.....	F-5501	Air Filter Set.....	A-5522-S	Air Filter Set.....	A-5541M-S
Oil Filter Full Flow.....	0-5501	Air Filter Primary.....	A-5509	Air Filter Primary.....	A-5541M
<i>(ENGINES)</i> CAT (S/N: 36J1-36J560)		Fuel Filter.....	F-5505	Air Filter Secondary.....	A-5540
Air Filter.....	A-5518	Fuel Filter.....	F-5501	Air Filter Primary.....	A-5541
Fuel Filter.....	F-5501	Oil Filter Full Flow.....	0-5503	Oil Filter Full Flow.....	C-5102
Oil Filter Full Flow.....	0-5503	<i>(ENGINES)</i> CAT 1673C		<i>(ENGINES)</i> CAT 3056	
<i>(ENGINES)</i> CAT (S/N: 38B-38B)		Air Filter Primary.....	A-5509	Oil Filter Full Flow.....	C-5101
Air Filter.....	A-5596	Air Filter Set.....	A-5522-S	<i>(ENGINES)</i> CAT 3114	
Coolant Filter.....	WC-5707	Air Filter.....	A-5596	Fuel Filter Secondary.....	FC-5515
Fuel Filter.....	F-5501	Fuel Filter.....	FC-5501	Fuel Filter.....	FC-5516
Fuel Filter Secondary.....	FC-55151	Fuel Filter.....	F-5505	Fuel Filter Secondary.....	FC-55151
Fuel Filter.....	FC-5516	Oil Filter Full Flow.....	0-5501	Oil Filter Full Flow.....	C-5510
Fuel Filter Secondary.....	FC-5515	<i>(ENGINES)</i> CAT 1674		Oil Filter Full Flow.....	C-5522
Oil Filter Full Flow.....	0-5503	Air Filter.....	A-5596	<i>(ENGINES)</i> CAT 3116TA (S/N: 1SK/4KG-UP)	
<i>(ENGINES)</i> CAT (S/N: 38J193-UP)		Air Filter.....	A-5506	Fuel Filter Secondary.....	FC-5507
Air Filter.....	A-5518	Fuel Filter.....	F-5505	Oil Filter Full Flow.....	C-5505
Fuel Filter.....	F-5501	Oil Filter Full Flow.....	0-5501	Oil Filter Full Flow.....	C-5510
<i>(ENGINES)</i> CAT (S/N: 8NM/6SR-UP)		<i>(ENGINES)</i> CAT 1676		Fuel Filter Secondary.....	FC-5515
Air Filter.....	A-5518	Air Filter.....	A-5506	<i>(ENGINES)</i> CAT 3126TA (S/N: 8NM/6SR-UP)	
Fuel Filter.....	F-5501	Air Filter.....	A-5596	Fuel Filter Secondary.....	FC-5515

MODEL/APPLICATION SAKURA NO
CATERPILLAR

(ENGINES)
CAT 3126TA (S/N: 8NM/6SR-UP)

- Fuel Filter Secondary..... FC-55151
- Fuel Filter..... FC-5516

(ENGINES)
CAT 3145

- Fuel Filter..... FC-5503
- Oil Filter Full Flow..... C-5504

(ENGINES)
CAT 3145 (S/N: 96M1-96M1)

- Fuel Filter..... FC-5503
- Oil Filter Full Flow..... C-5504

(ENGINES)
CAT 3160 (S/N: 67P1-UP)

- Air Filter..... AS-5002
- Fuel Filter..... FC-5503
- Oil Filter Full Flow..... C-5504

(ENGINES)
CAT 3160 (S/N: 68M1-UP)

- Air Filter..... AS-5002
- Fuel Filter..... FC-5503
- Oil Filter Full Flow..... C-5504

(ENGINES)
CAT 3160 (S/N: 68P1-586)

- Fuel Filter..... FC-5503
- Oil Filter Full Flow..... C-5504

(ENGINES)
CAT 3160 (S/N: 68P1-68P586)

- Fuel Filter..... FC-5503
- Oil Filter Full Flow..... C-5504

(ENGINES)
CAT 3160 (S/N: 68P587-UP)

- Air Filter..... AS-5002
- Fuel Filter..... FC-5503
- Oil Filter Full Flow..... C-5504

(ENGINES)
CAT 3160 (S/N: 98M1-UP)

- Fuel Filter..... FC-5503
- Oil Filter Full Flow..... C-5504

(ENGINES)
CAT 3160 (S/N: 98M-98M)

- Fuel Filter..... FC-5503
- Oil Filter Full Flow..... C-5504

(ENGINES)
CAT 3176T

- Air Filter Secondary..... A-5522
- Air Filter Set..... A-5522-S
- Air Filter Primary..... A-5509
- Fuel Filter..... FC-5519
- Oil Filter Full Flow..... C-5516

(ENGINES)
CAT 3196 (S/N: 2XR-UP)

- Fuel Filter..... FC-5519
- Oil Filter Full Flow..... C-5516

MODEL/APPLICATION SAKURA NO
CATERPILLAR

(ENGINES)
CAT 3208

- Air Filter Secondary..... A-5525
- Air Filter Primary..... A-5542
- Air Filter Set..... A-5542-S
- Fuel Filter Secondary..... FC-5507
- Fuel Filter..... FC-5503
- Oil Filter Full Flow..... C-5519
- Oil Filter Full Flow..... C-5504
- Oil Filter Full Flow..... C-5505

(ENGINES)
CAT 3208 (S/N: 32Y5336-32Y6000)

- Oil Filter Full Flow..... C-5505
- Oil Filter Full Flow..... C-5519
- Oil Filter Full Flow..... C-5504

(ENGINES)
CAT 3208 (S/N: 51Z1-UP)

- Fuel Filter Secondary..... FC-5507
- Fuel/Water Separator..... SF-5704
- Oil Filter Full Flow..... C-5505
- Oil Filter Full Flow..... C-5504
- Oil Filter Full Flow..... C-5519

(ENGINES)
CAT 3208 (S/N: 75V4191-75V4192)

- Oil Filter Full Flow..... C-5505
- Oil Filter Full Flow..... C-5519
- Oil Filter Full Flow..... C-5504

(ENGINES)
CAT 3208 (S/N: 75V4192-75V4249)

- Air Filter..... A-5553
- Oil Filter Full Flow..... C-5504
- Oil Filter Full Flow..... C-5519
- Oil Filter Full Flow..... C-5505

(ENGINES)
CAT 3208 (S/N: 75V4316-UP)

- Oil Filter Full Flow..... C-5505
- Oil Filter Full Flow..... C-5519
- Oil Filter Full Flow..... C-5504

(ENGINES)
CAT 3208 (S/N: 79V-79V)

- Air Filter Secondary..... A-5510
- Oil Filter Full Flow..... C-5504
- Oil Filter Full Flow..... C-5519
- Oil Filter Full Flow..... C-5505

(ENGINES)
CAT 3208 (S/N: 90N39454-UP)

- Air Filter..... A-5553
- Oil Filter Full Flow..... C-5505
- Oil Filter Full Flow..... C-5519
- Oil Filter Full Flow..... C-5504

(ENGINES)
CAT 3208 (S/N: 90N-90N)

- Air Filter..... A-5553
- Fuel/Water Separator..... SFC-5705
- Oil Filter Full Flow..... C-5504
- Oil Filter Full Flow..... C-5519
- Oil Filter Full Flow..... C-5505

MODEL/APPLICATION SAKURA NO
CATERPILLAR

(ENGINES)
CAT 3208 SERIES

- Fuel Filter Secondary..... FC-5507
- Oil Filter Full Flow..... C-5505
- Oil Filter Full Flow..... C-5519
- Oil Filter Full Flow..... C-5504

(ENGINES)
CAT 3208T (S/N: 01Z-UP)

- Oil Filter Full Flow..... C-5504
- Oil Filter Full Flow..... C-5519
- Oil Filter Full Flow..... C-5505

(ENGINES)
CAT 3208T (S/N: 1Z1-UP)

- Fuel/Water Separator..... SF-5704
- Oil Filter Full Flow..... C-5505
- Oil Filter Full Flow..... C-5504

(ENGINES)
CAT 3208T (S/N: 2Z1-UP)

- Oil Filter Full Flow..... C-5504
- Oil Filter Full Flow..... C-5519
- Oil Filter Full Flow..... C-5505

(ENGINES)
CAT 3208T (S/N: 3Z1-UP)

- Air Filter..... A-5553
- Oil Filter Full Flow..... C-5519
- Oil Filter Full Flow..... C-5504
- Oil Filter Full Flow..... C-5505

(ENGINES)
CAT 3208TA (S/N: 01Z - 375 HP-UP)

- Fuel Filter Secondary..... FC-5507
- Oil Filter Full Flow..... C-5505

(ENGINES)
CAT 3208TA (S/N: 01Z-435 HP)

- Fuel Filter Secondary..... FC-5507
- Oil Filter Full Flow..... C-5505

(ENGINES)
CAT 3208TA (S/N: 01Z-UP)

- Fuel Filter Secondary..... FC-5507
- Oil Filter Full Flow..... C-5505

(ENGINES)
CAT 3208TA (S/N: 01Z-UP)

- Fuel Filter Secondary..... FC-5507
- Oil Filter Full Flow..... C-5505

(ENGINES)
CAT 3304 (S/N: 2B-2B)

- Fuel/Water Separator..... SFC-5705
- Oil Filter Full Flow..... C-5510

(ENGINES)
CAT 3304 (S/N: 2B4226-UP)

- Oil Filter Full Flow..... C-5510

(ENGINES)
CAT 3304 (S/N: 37Y1-UP)

- Air Filter..... A-5505
- Air Filter..... A-5504
- Coolant Filter..... WC-5707
- Coolant Filter..... WC-5705

Sakura Filter

ENGINE APPLICATION

MODEL/APPLICATION	SAKURA NO	MODEL/APPLICATION	SAKURA NO	MODEL/APPLICATION	SAKURA NO
CATERPILLAR		CATERPILLAR		CATERPILLAR	
(ENGINES) CAT 3406C (S/N: 6TB9857-UP)	Air Filter Primary..... A-5521 Air Filter Set..... A-5521-S	(ENGINES) CAT 3408B (S/N: 6RJ1-UP)	Air Filter Secondary..... A-5529	Air Filter..... A-5513 Fuel Filter..... FC-5519 Fuel/Water Separator..... SF-5704 Oil Filter Full Flow..... C-5516	
(ENGINES) CAT 3406C (S/N: 8PN1-UP)	Air Filter Set..... A-5521-S Air Filter Primary..... A-5521	(ENGINES) CAT 3408B (S/N: 78Z1144-4866)	Air Filter Secondary..... A-5529 Fuel Filter..... FC-5509 Oil Filter Full Flow..... C-5516	(ENGINES) CAT 3412 (S/N: 60M1-5160)	Air Filter..... A-5513 Fuel Filter..... FC-5509 Oil Filter Full Flow..... C-5516
(ENGINES) CAT 3406C (S/N: 977600754A-UP)	Air Filter Secondary..... A-8580 Air Filter Primary..... A-8665M Fuel Filter..... FC-5509 Oil Filter Full Flow..... C-5516	(ENGINES) CAT 3408B (S/N: 8RG1-UP)	Air Filter Secondary..... A-5529 Fuel Filter..... FC-5509	(ENGINES) CAT 3412 (S/N: 60M1-UP)	Air Filter..... A-5513 Fuel Filter..... FC-5519 Fuel/Water Separator..... SF-5704 Oil Filter Full Flow..... C-5516
(ENGINES) CAT 3408 (S/N: 18V1-UP)	Fuel Filter..... FC-5519 Oil Filter Full Flow..... C-5516	(ENGINES) CAT 3408B (S/N: 99U4589-UP)	Air Filter Secondary..... A-5529 Oil Filter Full Flow..... C-5516	(ENGINES) CAT 3412 (S/N: 60M-60M)	Air Filter..... A-5513 Fuel Filter..... FC-5519 Oil Filter Full Flow..... C-5516
(ENGINES) CAT 3408 (S/N: 28V1-UP)	Fuel Filter..... FC-5519 Oil Filter Full Flow..... C-5516	(ENGINES) CAT 3408B (S/N: 9TD1-UP)	Air Filter Secondary..... A-5529 Fuel Filter..... FC-5509 Oil Filter Full Flow..... C-5516	(ENGINES) CAT 3412 (S/N: 6ZM1-UP)	Oil Filter Full Flow..... C-5516
(ENGINES) CAT 3408 (S/N: 67U1-UP)	Fuel Filter..... FC-5519 Oil Filter Full Flow..... C-5516	(ENGINES) CAT 3408C (S/N: 1TS1-UP)	Fuel Filter..... FC-5519 Fuel/Water Separator..... SF-5704	(ENGINES) CAT 3412 (S/N: 7BL1-UP)	Fuel Filter..... FC-5509 Fuel/Water Separator..... SF-5704
(ENGINES) CAT 3408 (S/N: 99U1-UP)	Air Filter..... A-5513 Fuel Filter..... FC-5519 Oil Filter Full Flow..... C-5516	(ENGINES) CAT 3408C (S/N: 67U16071-UP)	Fuel Filter..... FC-5519	(ENGINES) CAT 3412 (S/N: 7DB1-UP)	Air Filter Primary..... A-5521 Air Filter Set..... A-5521-S Air Filter Secondary..... A-5552 Oil Filter Full Flow..... C-5516
(ENGINES) CAT 3408 SERIES	Air Filter..... A-5517 Coolant Filter..... WC-5705 Fuel Filter..... FC-5519 Oil Filter Full Flow..... C-5516	(ENGINES) CAT 3408C (S/N: 78Z4867-UP)	Fuel Filter..... FC-5519	(ENGINES) CAT 3412 (S/N: 81Z1-14500)	Fuel Filter..... FC-5509 Oil Filter Full Flow..... C-5516
(ENGINES) CAT 3408B (S/N: 1LG1-UP)	Air Filter Secondary..... A-5529 Oil Filter Full Flow..... C-5516	(ENGINES) CAT 3408C (S/N: 9ER1-UP)	Fuel Filter..... FC-5519	(ENGINES) CAT 3412 (S/N: 9RR1-UP)	Oil Filter Full Flow..... C-5516
(ENGINES) CAT 3408B (S/N: 28V4750-UP)	Air Filter Secondary..... A-5529	(ENGINES) CAT 3408C (S/N: 9XM1-UP)	Fuel Filter..... FC-5509	(ENGINES) CAT 3412 (S/N: 9XF1-UP)	Fuel Filter..... FC-5509 Oil Filter Full Flow..... C-5516
(ENGINES) CAT 3408B (S/N: 28G1-UP)	Air Filter Secondary..... A-5529 Fuel Filter..... FC-5509 Oil Filter Full Flow..... C-5516	(ENGINES) CAT 3408E (S/N: 99C1-UP)	Oil Filter Full Flow..... C-5516	(ENGINES) CAT 3412 SERIES	Fuel Filter..... FC-5519 Oil Filter Full Flow..... C-5516
(ENGINES) CAT 3408B (S/N: 67U11135-16070)	Air Filter Secondary..... A-5529 Oil Filter Full Flow..... C-5516	(ENGINES) CAT 3412 (S/N: 2WJ1-UP)	Fuel Filter..... FC-5509 Oil Filter Full Flow..... C-5516	(ENGINES) CAT 3412 SERIES (ALL)	Fuel Filter..... FC-5519 Oil Filter Full Flow..... C-5516
(ENGINES) CAT 3408B (S/N: 6NB1-UP)		(ENGINES) CAT 3412 (S/N: 38S1-16483)	Fuel Filter..... FC-5509 Oil Filter Full Flow..... C-5516	(ENGINES) CAT 3412 TA	Air Filter..... A-5518
		(ENGINES) CAT 3412 (S/N: 38S1-UP)			

Sakura Filter

ENGINE APPLICATION

MODEL/APPLICATION	SAKURA NO
CATERPILLAR	
<i>(ENGINES)</i>	
CAT 3412C (S/N: 3JK-UP)	
Fuel Filter.....	FC-5509
Oil Filter Full Flow.....	C-5510
<i>(ENGINES)</i>	
CAT 3412C (S/N: 81Z14501-UP)	
Fuel Filter.....	FC-5509
Oil Filter Full Flow.....	C-5516
<i>(ENGINES)</i>	
CAT 3412C (S/N: 9BR1-UP)	
Fuel/Water Separator.....	SF-5704
<i>(ENGINES)</i>	
CAT 3412E (S/N: 80M1-UP)	
Oil Filter Full Flow.....	C-5516
<i>(ENGINES)</i>	
CAT 345 B	
Air Filter Primary.....	A-8665M
Air Filter Secondary.....	A-8580
Cabin Air Filter.....	CA-55850
Fuel/Water Separator Secondary..	SFC-5504-10B
Fuel/Water Separator Secondary..	SFC-5504-10
Hydraulic Oil Filter.....	HC-5801
Hydraulic Oil Filter.....	H-7942
<i>(ENGINES)</i>	
CAT 345 BL	
Air Filter Secondary.....	A-8580
Air Filter Primary.....	A-8665M
Cabin Air Filter.....	CA-55850
Fuel/Water Separator Secondary..	SFC-5504-10
Fuel/Water Separator Secondary..	SFC-5504-10B
Hydraulic Oil Filter.....	H-7942
Hydraulic Oil Filter.....	HC-5801
<i>(ENGINES)</i>	
CAT 3508	
Air Filter Set.....	A-5521-S
Air Filter Primary.....	A-5521
Air Filter Primary.....	A-5531
Air Filter Set.....	A-5531-S
Air Filter Secondary.....	A-5552
Air Filter Secondary.....	A-5533
Fuel Filter.....	F-5504
Fuel Filter.....	FC-5506
Fuel Filter.....	FC-5510
Oil Filter Full Flow.....	O-5504
Oil Filter Full Flow.....	C-5516
<i>(ENGINES)</i>	
CAT 3508 (S/N: 1ZF1-UP)	
Air Filter Set.....	A-5531-S
Air Filter Primary.....	A-5531
Air Filter Secondary.....	A-5533
Fuel Filter.....	FC-5519
Oil Filter Full Flow.....	C-5516
<i>(ENGINES)</i>	
CAT 3508 (S/N: 23Z1-UP)	
Air Filter Primary.....	A-5531
Air Filter Set.....	A-5531-S
Air Filter Secondary.....	A-5533

MODEL/APPLICATION	SAKURA NO
CATERPILLAR	
Fuel Filter.....	F-5504
Oil Filter Full Flow.....	C-5516
<i>(ENGINES)</i>	
CAT 3508 (S/N: 4ZL1-UP)	
Fuel Filter.....	FC-5506
<i>(ENGINES)</i>	
CAT 3508 (S/N: 5TL1-UP)	
Fuel Filter.....	FC-5510
<i>(ENGINES)</i>	
CAT 3508 (S/N: 68Z1-68Z1)	
Air Filter Set.....	A-5531-S
Air Filter Primary.....	A-5531
Air Filter Secondary.....	A-5533
Fuel Filter.....	F-5504
Fuel Filter.....	FC-5510
Oil Filter Full Flow.....	C-5516
<i>(ENGINES)</i>	
CAT 3508 (S/N: 68Z1-UP)	
Air Filter Secondary.....	A-5533
Air Filter Primary.....	A-5531
Air Filter Set.....	A-5531-S
Fuel Filter.....	FC-5506
Fuel Filter.....	F-5504
Oil Filter Full Flow.....	C-5516
<i>(ENGINES)</i>	
CAT 3508 (S/N: 69Z1-UP)	
Air Filter Set.....	A-5531-S
Air Filter Primary.....	A-5531
Air Filter Secondary.....	A-5533
Fuel Filter.....	F-5504
Oil Filter Full Flow.....	O-5504
Oil Filter Full Flow.....	C-5516
<i>(ENGINES)</i>	
CAT 3508 (S/N: 6TJ1-UP)	
Air Filter Secondary.....	A-5533
Air Filter Primary.....	A-5531
Air Filter Set.....	A-5531-S
Oil Filter Full Flow.....	O-5504
<i>(ENGINES)</i>	
CAT 3508 (S/N: 70Z1-UP)	
Air Filter Set.....	A-5531-S
Air Filter Primary.....	A-5531
Air Filter Secondary.....	A-5533
Fuel Filter.....	F-5504
Fuel Filter.....	FC-5506
Oil Filter Full Flow.....	C-5516
<i>(ENGINES)</i>	
CAT 3508 (S/N: 95Y1-UP)	
Air Filter Secondary.....	A-5533
Air Filter Primary.....	A-5531
Air Filter Set.....	A-5531-S
Fuel Filter.....	F-5504
Oil Filter Full Flow.....	C-5516
Oil Filter Full Flow.....	O-5504
<i>(ENGINES)</i>	
CAT 3508 (S/N: 96Y1-96Y1)	
Air Filter Set.....	A-5531-S

MODEL/APPLICATION	SAKURA NO
CATERPILLAR	
Air Filter Primary.....	A-5531
Air Filter Secondary.....	A-5533
Fuel Filter.....	F-5504
Oil Filter Full Flow.....	C-5516
<i>(ENGINES)</i>	
CAT 3508 (S/N: 96Y1-UP)	
Air Filter Primary.....	A-5531
Air Filter Set.....	A-5531-S
Oil Filter Full Flow.....	O-5504
<i>(ENGINES)</i>	
CAT 3508 (S/N: 97Y1-UP)	
Air Filter Set.....	A-5531-S
Air Filter Primary.....	A-5531
Air Filter Secondary.....	A-5533
Fuel Filter.....	F-5504
Fuel Filter.....	FC-5510
Oil Filter Full Flow.....	C-5516
<i>(ENGINES)</i>	
CAT 3508 (S/N: 9TG1-UP)	
Oil Filter Full Flow.....	O-5504
<i>(ENGINES)</i>	
CAT 3508B (S/N: 2GR1-UP)	
Fuel Filter.....	FC-5519
<i>(ENGINES)</i>	
CAT 3508B (S/N: 3DM1-UP)	
Air Filter Secondary.....	A-5533
Air Filter Primary.....	A-5531
Air Filter Set.....	A-5531-S
Fuel Filter.....	FC-5510
Oil Filter Full Flow.....	O-5504
<i>(ENGINES)</i>	
CAT 3508B (S/N: 4GM1-UP)	
Air Filter Set.....	A-5531-S
Air Filter Primary.....	A-5531
Air Filter Secondary.....	A-5533
Fuel Filter.....	F-5504
Oil Filter Full Flow.....	C-5516
<i>(ENGINES)</i>	
CAT 3508B (S/N: 6PN1-UP)	
Air Filter Secondary.....	A-5533
Air Filter Primary.....	A-5531
Air Filter Set.....	A-5531-S
Fuel Filter.....	FC-5519
Fuel Filter.....	FC-5509
Oil Filter Full Flow.....	O-5504
<i>(ENGINES)</i>	
CAT 3508B (S/N: 7SM1-UP)	
Air Filter Set.....	A-5531-S
Air Filter Primary.....	A-5531
Air Filter Secondary.....	A-5533
Fuel Filter.....	FC-5510
Oil Filter Full Flow.....	O-5504
<i>(ENGINES)</i>	
CAT 3512 (S/N: 1LM1-UP)	
Air Filter Secondary.....	A-5533
Air Filter Primary.....	A-5531
Air Filter Set.....	A-5531-S

MODEL/APPLICATION	SAKURA NO
CATERPILLAR	
<i>(ENGINES)</i>	
CAT 3512 (S/N: 1LM1-UP)	
Fuel Filter.....	FC-5506
Oil Filter Full Flow.....	C-5516
<i>(ENGINES)</i>	
CAT 3512 (S/N: 24Z1-UP)	
Air Filter Set.....	A-5531-S
Air Filter Primary.....	A-5531
Air Filter Secondary.....	A-5533
Fuel Filter.....	F-5504
Oil Filter Full Flow.....	O-5504
Oil Filter Full Flow.....	C-5516
<i>(ENGINES)</i>	
CAT 3512 (S/N: 2WK1-UP)	
Air Filter Secondary.....	A-5533
Air Filter Primary.....	A-5531
Air Filter Set.....	A-5531-S
Oil Filter Full Flow.....	O-5504
<i>(ENGINES)</i>	
CAT 3512 (S/N: 3YF1-UP)	
Air Filter Set.....	A-5531-S
Air Filter Primary.....	A-5531
Air Filter Secondary.....	A-5533
Fuel Filter.....	FC-5509
Oil Filter Full Flow.....	O-5504
Oil Filter Full Flow.....	C-5516
<i>(ENGINES)</i>	
CAT 3512 (S/N: 49Y1-UP)	
Air Filter Primary.....	A-5531
Air Filter Set.....	A-5531-S
Air Filter Secondary.....	A-5533
Fuel Filter.....	F-5504
Oil Filter Full Flow.....	O-5504
Oil Filter Full Flow.....	C-5516
<i>(ENGINES)</i>	
CAT 3512 (S/N: 50Y1-UP)	
Air Filter Set.....	A-5531-S
Air Filter Primary.....	A-5531
Air Filter Secondary.....	A-5533
Fuel Filter.....	F-5504
Oil Filter Full Flow.....	C-5516
<i>(ENGINES)</i>	
CAT 3512 (S/N: 51Y1-UP)	
Air Filter Secondary.....	A-5533
Air Filter Primary.....	A-5531
Air Filter Set.....	A-5531-S
Fuel Filter.....	FC-5506
Oil Filter Full Flow.....	C-5516
<i>(ENGINES)</i>	
CAT 3512 (S/N: 65Z1-UP)	
Air Filter Set.....	A-5531-S
Air Filter Primary.....	A-5531
Air Filter Secondary.....	A-5533
Fuel Filter.....	F-5504
Fuel Filter.....	FC-5506
Oil Filter Full Flow.....	C-5516

MODEL/APPLICATION	SAKURA NO
CATERPILLAR	
<i>(ENGINES)</i>	
CAT 3512 (S/N: 66Z1-UP)	
Air Filter Secondary.....	A-5533
Air Filter Primary.....	A-5531
Air Filter Set.....	A-5531-S
Fuel Filter.....	FC-5506
Fuel Filter.....	F-5504
Oil Filter Full Flow.....	C-5516
<i>(ENGINES)</i>	
CAT 3512 (S/N: 67Z1-UP)	
Air Filter Set.....	A-5531-S
Air Filter Primary.....	A-5531
Air Filter Secondary.....	A-5533
Fuel Filter.....	F-5504
Fuel Filter.....	FC-5506
Oil Filter Full Flow.....	C-5516
<i>(ENGINES)</i>	
CAT 3512 (S/N: 6FL1-UP)	
Fuel Filter.....	FC-5510
<i>(ENGINES)</i>	
CAT 3512 (S/N: 70Z1-UP)	
Air Filter Primary.....	A-5531
Air Filter Set.....	A-5531-S
Fuel Filter.....	F-5504
Oil Filter Full Flow.....	O-5504
<i>(ENGINES)</i>	
CAT 3512 (S/N: 7NJ1-UP)	
Oil Filter Full Flow.....	O-5504
<i>(ENGINES)</i>	
CAT 3512B (S/N: 4TN1-UP)	
Air Filter Set.....	A-5531-S
Air Filter Primary.....	A-5531
Air Filter Secondary.....	A-5533
Fuel Filter.....	FC-5510
Oil Filter Full Flow.....	O-5504
<i>(ENGINES)</i>	
CAT 3512B (S/N: 6WN1-UP)	
Air Filter Secondary.....	A-5533
Air Filter Primary.....	A-5531
Air Filter Set.....	A-5531-S
Oil Filter Full Flow.....	C-5516
<i>(ENGINES)</i>	
CAT 3512B (S/N: 7HM1-UP)	
Air Filter Set.....	A-5531-S
Air Filter Primary.....	A-5531
Air Filter Secondary.....	A-5533
Fuel Filter.....	FC-5510
Oil Filter Full Flow.....	C-5516
<i>(ENGINES)</i>	
CAT 3512B (S/N: 8EM1-UP)	
Air Filter Secondary.....	A-5533
Air Filter Primary.....	A-5531
Air Filter Set.....	A-5531-S
Fuel Filter.....	FC-5510
Oil Filter Full Flow.....	O-5504
<i>(ENGINES)</i>	
CAT 3512B (S/N: 8RM1-UP)	

MODEL/APPLICATION	SAKURA NO
CATERPILLAR	
Air Filter Set.....	A-5531-S
Air Filter Primary.....	A-5531
Air Filter Secondary.....	A-5533
Fuel Filter.....	FC-5519
Fuel Filter.....	FC-5510
Oil Filter Full Flow.....	O-5504
<i>(ENGINES)</i>	
CAT 3516	
Air Filter Secondary.....	A-5533
Air Filter Secondary.....	A-5552
Air Filter.....	A-5551
Air Filter Set.....	A-5551-S
Air Filter Primary.....	A-5531
Air Filter Set.....	A-5531-S
Air Filter Primary.....	A-5521
Air Filter Set.....	A-5521-S
Oil Filter Full Flow.....	O-5504
<i>(ENGINES)</i>	
CAT 3516 (S/N: 25Z1-UP)	
Air Filter Set.....	A-5531-S
Air Filter Primary.....	A-5531
Air Filter Secondary.....	A-5533
Fuel Filter.....	FC-5519
Oil Filter Full Flow.....	C-5516
Oil Filter Full Flow.....	O-5504
<i>(ENGINES)</i>	
CAT 3516 (S/N: 27Z1-UP)	
Air Filter Primary.....	A-5531
Air Filter Set.....	A-5531-S
Air Filter Secondary.....	A-5533
Fuel Filter.....	F-5504
Fuel Filter.....	FC-5506
Oil Filter Full Flow.....	C-5516
<i>(ENGINES)</i>	
CAT 3516 (S/N: 28Z1-UP)	
Air Filter Set.....	A-5531-S
Air Filter Primary.....	A-5531
Air Filter Secondary.....	A-5533
Fuel Filter.....	FC-5506
Oil Filter Full Flow.....	C-5516
<i>(ENGINES)</i>	
CAT 3516 (S/N: 29Z1-UP)	
Air Filter Secondary.....	A-5533
Air Filter Primary.....	A-5531
Air Filter Set.....	A-5531-S
Fuel Filter.....	FC-5506
Fuel Filter.....	F-5504
Oil Filter Full Flow.....	C-5516
<i>(ENGINES)</i>	
CAT 3516 (S/N: 4MJ1-UP)	
Air Filter Set.....	A-5531-S
Air Filter Primary.....	A-5531
Air Filter Secondary.....	A-5533
Fuel Filter.....	FC-5506
Oil Filter Full Flow.....	C-5516
<i>(ENGINES)</i>	
CAT 3516 (S/N: 4XF1-UP)	
Air Filter Secondary.....	A-5533

Sakura Filter

ENGINE APPLICATION

MODEL/APPLICATION	SAKURA NO	MODEL/APPLICATION	SAKURA NO	MODEL/APPLICATION	SAKURA NO
CATERPILLAR		CATERPILLAR		CATERPILLAR	
(ENGINES) CAT 3516 (S/N: 4XF1-UP)		(ENGINES) CAT 3516B (S/N: 7RN1-UP)		(ENGINES) CAT 3612	
Air Filter Primary.....	A-5531	Air Filter Set.....	A-5531-S	Air Filter Set.....	A-5531-S
Air Filter Set.....	A-5531-S	Air Filter Primary.....	A-5531	Air Filter Primary.....	A-5531
Fuel Filter.....	FC-5519	Air Filter Secondary.....	A-5533	Air Filter Set.....	A-5521-S
Fuel Filter.....	FC-5509	Fuel Filter.....	FC-5519	Air Filter Primary.....	A-5521
Oil Filter Full Flow.....	C-5516	Fuel Filter.....	FC-5510	Air Filter Secondary.....	A-5552
		Oil Filter Full Flow.....	0-5504	Oil Filter Full Flow.....	0-5504
(ENGINES) CAT 3516 (S/N: 5S11-UP)		(ENGINES) CAT 3516B (S/N: 8CN1-UP)		(ENGINES) CAT 3612 (S/N: 1YG1-UP)	
Air Filter Set.....	A-5531-S	Air Filter Secondary.....	A-5533	Air Filter Secondary.....	A-5552
Air Filter Primary.....	A-5531	Air Filter Primary.....	A-5531	Air Filter Primary.....	A-5521
Air Filter Secondary.....	A-5533	Air Filter Set.....	A-5531-S	Air Filter Set.....	A-5521-S
Fuel Filter.....	F-5504	Fuel Filter.....	FC-5510	Air Filter Primary.....	A-5531
Fuel Filter.....	FC-5506	Oil Filter Full Flow.....	C-5516	Air Filter Set.....	A-5531-S
Oil Filter Full Flow.....	C-5516			Fuel Filter.....	F-55200
(ENGINES) CAT 3516 (S/N: 71Z1-UP)		(ENGINES) CAT 3516B (S/N: 8KN1-UP)		(ENGINES) CAT 3612 (S/N: 9RC1-UP)	
Air Filter Secondary.....	A-5533	Air Filter Set.....	A-5531-S	Fuel Filter.....	F-55200
Air Filter Primary.....	A-5531	Air Filter Primary.....	A-5531	Oil Filter Full Flow.....	0-55090
Air Filter Set.....	A-5531-S	Air Filter Secondary.....	A-5533		
Fuel Filter.....	F-5504	Fuel Filter.....	FC-5510	(ENGINES) CAT 3616 (S/N: 1PD1-UP)	
Oil Filter Full Flow.....	0-5504	Oil Filter Full Flow.....	0-5504	Fuel Filter.....	F-55200
Oil Filter Full Flow.....	C-5516			Oil Filter Full Flow.....	0-55090
(ENGINES) CAT 3516 (S/N: 72Z1-UP)		(ENGINES) CAT 3516B (S/N: 9AN1-UP)		(ENGINES) CAT 3616 (S/N: 4CG1-UP)	
Air Filter Set.....	A-5531-S	Air Filter Secondary.....	A-5533	Fuel Filter.....	FC-5509
Air Filter Primary.....	A-5531	Air Filter Primary.....	A-5531		
Air Filter Secondary.....	A-5533	Air Filter Set.....	A-5531-S	(ENGINES) CAT 40B (S/N: 40B-40B)	
Air Filter.....	A-44250	Fuel Filter.....	FC-5510	Fuel Filter.....	F-5501
Fuel Filter.....	F-5504	Oil Filter Full Flow.....	0-5504	Oil Filter Full Flow.....	0-5503
Fuel Filter.....	FC-5506				
Oil Filter Full Flow.....	C-5516	(ENGINES) CAT 3600		(ENGINES) CAT 40J1-245 (S/N: 40J1-40J245)	
Oil Filter Full Flow.....	0-5504	Fuel Filter.....	F-55200	Air Filter.....	A-5518
(ENGINES) CAT 3516 (S/N: 73Z1-UP)		(ENGINES) CAT 3606		Fuel Filter.....	F-5501
Air Filter Secondary.....	A-5533	Fuel Filter.....	F-55200	Oil Filter Full Flow.....	0-5503
Air Filter Primary.....	A-5531	Oil Filter Full Flow.....	0-55090		
Air Filter Set.....	A-5531-S	(ENGINES) CAT 3606 (S/N: 3XF1-UP)		(ENGINES) CAT 40J246 (S/N: 40J246-40J246)	
Fuel Filter.....	FC-5506	Fuel Filter.....	F-55200	Air Filter.....	A-5518
Fuel Filter.....	F-5504			Fuel Filter.....	F-5501
Oil Filter Full Flow.....	C-5516	(ENGINES) CAT 3606 (S/N: 8RB1-UP)		Oil Filter Full Flow.....	0-5502
(ENGINES) CAT 3516 (S/N: 7CL1-UP)		Fuel Filter.....	F-55200		
Fuel Filter.....	FC-5510	Oil Filter Full Flow.....	0-55090	(ENGINES) CAT 40J246-UP (S/N: 40J246-UP)	
(ENGINES) CAT 3516 (S/N: 9KF1-UP)		(ENGINES) CAT 3608		Air Filter.....	A-5518
Air Filter Set.....	A-5531-S	Coolant Filter.....	WC-5705	Fuel Filter.....	F-5501
Air Filter Primary.....	A-5531	Fuel Filter.....	F-55200	Oil Filter Full Flow.....	0-5502
Air Filter Secondary.....	A-5533	Fuel Filter.....	FC-5519		
Oil Filter Full Flow.....	0-5504	Oil Filter Full Flow.....	C-5516	(ENGINES) CAT 40S1-UP (S/N: 40S1-UP)	
(ENGINES) CAT 3516B (S/N: 6HN1-UP)		Oil Filter Full Flow.....	0-55090	Fuel Filter Secondary.....	FC-5507
Air Filter Secondary.....	A-5533	(ENGINES) CAT 3608 (S/N: 4WF1-UP)		Fuel/Water Separator.....	SF-5704
Air Filter Primary.....	A-5531	Fuel Filter.....	F-55200	Oil Filter Full Flow.....	C-5505
Air Filter Set.....	A-5531-S			Oil Filter Full Flow.....	C-5504
Fuel Filter.....	FC-5509	(ENGINES) CAT 3608 (S/N: 6MC1-UP)		Oil Filter Full Flow.....	C-5519
Oil Filter Full Flow.....	C-5516	Fuel Filter.....	F-55200		
		(ENGINES) CAT 42B (S/N: 42B-42B)		Oil Filter Full Flow.....	0-5503
		Oil Filter Full Flow.....	0-5503		

Sakura Filter

ENGINE APPLICATION

MODEL/APPLICATION	SAKURA NO	MODEL/APPLICATION	SAKURA NO	MODEL/APPLICATION	SAKURA NO
CATERPILLAR					
<i>(ENGINES)</i> CAT 42B (S/N: 42B-42B)		<i>(ENGINES)</i> CAT 62B1-5886 (S/N: 62B1-62B5886)		<i>(ENGINES)</i> CAT 68B2540-UP (S/N: 68B2540-UP)	
		Air Filter.....	A-5506	Air Filter.....	A-5518
<i>(ENGINES)</i> CAT 43B (S/N: 43B-43B)		Fuel Filter.....	F-5501	Fuel Filter.....	F-5501
Oil Filter Full Flow.....	0-5503	Oil Filter Full Flow.....	0-5503	Oil Filter Full Flow.....	0-5502
<i>(ENGINES)</i> CAT 44B (S/N: 44B-44B)		<i>(ENGINES)</i> CAT 62B5887-UP (S/N: 62B5887-UP)		<i>(ENGINES)</i> CAT 68B630-2539 (S/N: 68B630-68B2539)	
Oil Filter Full Flow.....	0-5503	Air Filter.....	A-5506	Air Filter.....	A-5518
		Oil Filter Full Flow.....	0-5503	Fuel Filter.....	F-5501
<i>(ENGINES)</i> CAT 46B809-1557 (S/N: 46B809-46B1557)		<i>(ENGINES)</i> CAT 62P (S/N: 62P-62P)		Oil Filter Full Flow.....	0-5503
Fuel Filter.....	F-5501	Air Filter Secondary.....	A-7915	<i>(ENGINES)</i> CAT 68Z1-UP (S/N: 68Z1-UP)	
Oil Filter Full Flow.....	0-5503	Air Filter Primary.....	A-7912	Air Filter Set.....	A-5531-S
<i>(ENGINES)</i> CAT 47B1780 (S/N: 47B1780-47B1780)		Air Filter Set.....	A-7912-S	Air Filter Primary.....	A-5531
Air Filter.....	A-5517	Air Filter.....	A-5518	Oil Filter Full Flow.....	0-5504
Fuel/Water Separator.....	SFC-5705	Fuel Filter.....	F-5501	<i>(ENGINES)</i> CAT 69Z1-UP (S/N: 69Z1-UP)	
Oil Filter Full Flow.....	0-5503	Oil Filter Full Flow.....	0-5501	Air Filter Primary.....	A-5531
<i>(ENGINES)</i> CAT 47B409-1709 (S/N: 47B409-47B1709)		<i>(ENGINES)</i> CAT 65Z1 (S/N: 65Z1-65Z1)		Air Filter Set.....	A-5531-S
Fuel Filter.....	F-5501	Air Filter Primary.....	A-5531	Oil Filter Full Flow.....	0-5504
Oil Filter Full Flow.....	0-5503	Air Filter Set.....	A-5531-S	<i>(ENGINES)</i> CAT 70Z1 (S/N: 70Z1-70Z1)	
<i>(ENGINES)</i> CAT 4800		Air Filter Secondary.....	A-5533	Air Filter Set.....	A-5531-S
Oil Filter Full Flow.....	0-5505	Fuel Filter.....	F-5504	Air Filter Primary.....	A-5531
<i>(ENGINES)</i> CAT 49B (S/N: 49B-49B)		Oil Filter Full Flow.....	C-5516	Air Filter Secondary.....	A-5533
Fuel Filter.....	F-5501	Oil Filter Full Flow.....	0-5504	Fuel Filter.....	F-5504
Oil Filter Full Flow.....	0-5501	<i>(ENGINES)</i> CAT 66B636-3560 (S/N: 66B636-66B3560)		Oil Filter Full Flow.....	C-5516
<i>(ENGINES)</i> CAT 50B (S/N: 50B-50B)		Air Filter.....	A-5518	Oil Filter Full Flow.....	0-5504
Fuel Filter.....	F-5501	Fuel Filter.....	F-5501	<i>(ENGINES)</i> CAT 77B1-321 (S/N: 77B1-77B321)	
Oil Filter Full Flow.....	0-5501	Oil Filter Full Flow.....	0-5503	Air Filter.....	A-5517
<i>(ENGINES)</i> CAT 50Y1-UP (S/N: 50Y1-UP)		<i>(ENGINES)</i> CAT 66Z1 (S/N: 66Z1-66Z1)		Oil Filter Full Flow.....	0-5503
Air Filter Set.....	A-5531-S	Air Filter Set.....	A-5531-S	<i>(ENGINES)</i> CAT 79B (S/N: 79B-79B)	
Air Filter Primary.....	A-5531	Air Filter Primary.....	A-5531	Fuel Filter.....	F-5501
Air Filter Secondary.....	A-5533	Air Filter Secondary.....	A-5533	Oil Filter Full Flow.....	0-5501
Fuel Filter.....	F-5504	Fuel Filter.....	F-5504	<i>(ENGINES)</i> CAT 80B (S/N: 80B-80B)	
Oil Filter Full Flow.....	0-5504	Oil Filter Full Flow.....	C-5516	Fuel Filter.....	F-5501
Oil Filter Full Flow.....	C-5516	<i>(ENGINES)</i> CAT 66Z1-UP (S/N: 66Z1-UP)		Oil Filter Full Flow.....	0-5501
<i>(ENGINES)</i> CAT 5310 SERIES		Air Filter Secondary.....	A-5533	<i>(ENGINES)</i> CAT 81B (S/N: 81B-81B)	
Oil Filter Full Flow.....	C-5504	Air Filter Primary.....	A-5531	Fuel Filter.....	F-5501
<i>(ENGINES)</i> CAT 5310 SERIES (ALL)		Fuel Filter.....	F-5504	Oil Filter Full Flow.....	0-5501
Oil Filter Full Flow.....	C-5504	Oil Filter Full Flow.....	C-5516	<i>(ENGINES)</i> CAT 82B (S/N: 82B-82B)	
<i>(ENGINES)</i> CAT 59B (S/N: 59B-59B)		<i>(ENGINES)</i> CAT 67B1391 (S/N: 67B1391-67B1391)		Fuel Filter.....	F-5501
Fuel Filter.....	F-5501	Air Filter.....	A-5518	Oil Filter Full Flow.....	0-5501
Oil Filter Full Flow.....	0-5501	Fuel Filter.....	F-5501	<i>(ENGINES)</i> CAT 85B (S/N: 85B-85B)	
<i>(ENGINES)</i> CAT 60B (S/N: 60B-60B)		Oil Filter Full Flow.....	0-5501	Fuel Filter.....	F-5501
Fuel Filter.....	FC-5501	Oil Filter Full Flow.....	0-5502	Oil Filter Full Flow.....	0-5501
Oil Filter Full Flow.....	0-5503	<i>(ENGINES)</i> CAT 68B1-629 (S/N: 68B1-68B629)		<i>(ENGINES)</i> CAT 86B (S/N: 86B-86B)	
<i>(ENGINES)</i> CAT 62B1-5886 (S/N: 62B1-62B5886)		Air Filter.....	A-5506	Fuel Filter.....	F-5501
Air Filter.....	A-5506	Fuel Filter.....	F-5501	Oil Filter Full Flow.....	0-5501
Fuel Filter.....	F-5501	Oil Filter Full Flow.....	0-5503		
Oil Filter Full Flow.....	0-5503				

Sakura Filter

ENGINE APPLICATION

MODEL/APPLICATION	SAKURA NO	MODEL/APPLICATION	SAKURA NO	MODEL/APPLICATION	SAKURA NO
CATERPILLAR		CATERPILLAR		CATERPILLAR	
(ENGINES) CAT 87B (S/N: 87B-87B)		(ENGINES) CAT D311 (S/N: 7S-7S)		(ENGINES) CAT D326 (S/N: 27B1-UP)	
Fuel Filter.....	F-5501	Oil Filter Full Flow.....	0-5501	Oil Filter Full Flow.....	0-5502
Oil Filter Full Flow.....	0-5501				
(ENGINES) CAT 88B (S/N: 88B-88B)		(ENGINES) CAT D311 (S/N: 9S-9S)		(ENGINES) CAT D326 (S/N: 39B-39B)	
Fuel Filter.....	F-5501	Oil Filter Full Flow.....	0-5501	Fuel Filter.....	F-5501
Oil Filter Full Flow.....	0-5501			Oil Filter Full Flow.....	0-5503
(ENGINES) CAT 91B-386 (S/N: 91B1-91B386)		(ENGINES) CAT D315		(ENGINES) CAT D330 (S/N: 2B14363-2B14363)	
Air Filter.....	A-5518	Oil Filter Full Flow.....	0-5501	Air Filter.....	A-5504
Fuel Filter.....	F-5501	Oil Filter Full Flow.....	0-5505	Oil Filter Full Flow.....	0-5502
Oil Filter Full Flow.....	0-5503				
(ENGINES) CAT 91B387 (S/N: 91B387-91B387)		(ENGINES) CAT D315 (S/N: 48B-48B)		(ENGINES) CAT D330 (S/N: 2B14363-UP)	
Air Filter.....	A-5518	Oil Filter Full Flow.....	0-5501	Air Filter.....	A-5504
Fuel Filter.....	F-5501			Fuel Filter Secondary.....	FC-5507
Oil Filter Full Flow.....	0-5502	Oil Filter Full Flow.....	0-5501	Oil Filter Full Flow.....	0-5502
(ENGINES) CAT 93B (S/N: 93B-93B)		(ENGINES) CAT D315 (S/N: 52B-52B)		(ENGINES) CAT D330 (S/N: 2B-2B)	
Fuel Filter.....	FC-5501	Oil Filter Full Flow.....	0-5501	Air Filter.....	A-5504
Oil Filter Full Flow.....	0-5501			Fuel/Water Separator.....	SFC-5705
(ENGINES) CAT 97Y1-UP (S/N: 97Y1-UP)		(ENGINES) CAT D315 (S/N: 5V-5V)		Oil Filter Full Flow.....	0-5501
Air Filter Primary.....	A-5531	Oil Filter Full Flow.....	0-5501	(ENGINES) CAT D330 (S/N: 4B-4B)	
Air Filter Set.....	A-5531-S			Air Filter.....	A-5504
Oil Filter Full Flow.....	0-5504	(ENGINES) CAT D315 (S/N: 9S-9S)		Fuel/Water Separator.....	SFC-5705
(ENGINES) CAT 98M (S/N: 98M-98M)		Oil Filter Full Flow.....	0-5501	Oil Filter Full Flow.....	0-5501
Air Filter.....	AS-5002			(ENGINES) CAT D330 (S/N: 56B-56B)	
Fuel Filter.....	FC-5503	(ENGINES) CAT D318 (S/N: 3V-3V)		Fuel Filter.....	F-5501
Oil Filter Full Flow.....	C-5504	Oil Filter Full Flow.....	0-5501	Oil Filter Full Flow.....	0-5501
(ENGINES) CAT C2.2		(ENGINES) CAT D318 (S/N: 45B-45B)		(ENGINES) CAT D330 (S/N: 57B-57B)	
Fuel Filter.....	FC-5103	Oil Filter Full Flow.....	0-5501	Fuel Filter.....	F-5501
Oil Filter Full Flow.....	C-1123			Oil Filter Full Flow.....	0-5501
(ENGINES) CAT C3.3		(ENGINES) CAT D318 (S/N: 53B-53B)		(ENGINES) CAT D330 (S/N: 5B-5B)	
Oil Filter Full Flow.....	C-5101	Oil Filter Full Flow.....	0-5501	Air Filter.....	A-5504
(ENGINES) CAT D11000		(ENGINES) CAT D318 (S/N: 5V-5V)		Oil Filter Full Flow.....	0-5501
Oil Filter Full Flow.....	0-5404	Oil Filter Full Flow.....	0-5501	(ENGINES) CAT D330 (S/N: 98B1-UP)	
(ENGINES) CAT D13000		(ENGINES) CAT D318 (S/N: 6V-6V)		Air Filter.....	A-5504
Oil Filter Full Flow.....	0-5404	Oil Filter Full Flow.....	0-5501	Fuel Filter.....	F-5501
Oil Filter Full Flow.....	0-5502	(ENGINES) CAT D-320 (S/N: 63B-63B)		Oil Filter Full Flow.....	0-5501
(ENGINES) CAT D13000 (S/N: 2V5001-UP)		Fuel Filter.....	F-5501	(ENGINES) CAT D330 (S/N: 9VA1-UP)	
Oil Filter Full Flow.....	0-5502	Oil Filter Full Flow.....	0-5501	Air Filter Set.....	A-5573-S
(ENGINES) CAT D311		(ENGINES) CAT D326 (S/N: 25B1-25B156)		Air Filter Secondary.....	A-5534
Oil Filter Full Flow.....	0-5501	Oil Filter Full Flow.....	0-5503	Air Filter Primary.....	A-5535
Oil Filter Full Flow.....	0-5505			Air Filter Primary.....	A-5501
(ENGINES) CAT D311 (S/N: 4V-4V)		(ENGINES) CAT D326 (S/N: 25B157-UP)		Air Filter Secondary.....	A-5502
Oil Filter Full Flow.....	0-5501	Fuel Filter.....	F-6505	Fuel Filter Secondary.....	FC-5507
Oil Filter Full Flow.....	0-5505	Oil Filter Full Flow.....	0-5503	Hydraulic Oil Filter.....	H-5504
(ENGINES) CAT D311 (S/N: 4V-4V)		(ENGINES) CAT D326 (S/N: 26B1-UP)		Hydraulic Oil Filter.....	H-5503
Oil Filter Full Flow.....	0-5501	Oil Filter Full Flow.....	0-5503	Oil Filter Full Flow.....	C-5510

MODEL/APPLICATION	SAKURA NO	MODEL/APPLICATION	SAKURA NO	MODEL/APPLICATION	SAKURA NO
CATERPILLAR		CATERPILLAR		CATERPILLAR	
(ENGINES) CAT D330B (S/N: 98B1-UP)		(ENGINES) CAT D333C (S/N: 66D8891-UP)		Air Filter.....	A-5596
Fuel Filter.....	F-5501	Oil Filter Full Flow.....	C-5510	Coolant Filter.....	WC-5707
Oil Filter Full Flow.....	0-5502			Fuel Filter.....	F-5501
		(ENGINES) CAT D333C (S/N: 67D1-UP)		Fuel Filter Secondary.....	FC-5515
(ENGINES) CAT D330C (S/N: 481-6031)		Fuel/Water Separator.....	SF-5704	Fuel Filter Secondary.....	FC-55151
Air Filter.....	A-5504			Fuel Filter.....	FC-5516
Fuel Filter Secondary.....	FC-5507	(ENGINES) CAT D334 (S/N: 92B-92B)		Oil Filter Full Flow.....	0-5501
Oil Filter Full Flow.....	0-5502	Fuel Filter.....	FC-5501		
		Oil Filter Full Flow.....	0-5501	(ENGINES) CAT D-342 (S/N: 31B2040-31B2477)	
(ENGINES) CAT D330C (S/N: 486032-UP)				Fuel Filter.....	F-5501
Oil Filter Full Flow.....	C-5510	(ENGINES) CAT D-336 (S/N: 55B-55B)		Oil Filter Full Flow.....	0-5501
		Fuel Filter.....	FC-5501		
(ENGINES) CAT D330C (S/N: 5B1-UP)		Oil Filter Full Flow.....	0-5503	(ENGINES) CAT D-342 (S/N: 31B2478-UP)	
Air Filter Secondary.....	A-5502			Fuel Filter.....	F-5501
Air Filter Primary.....	A-5501	(ENGINES) CAT D337 (S/N: 22B1-22B861)		Oil Filter Full Flow.....	0-5501
Fuel Filter Secondary.....	FC-5507	Oil Filter Full Flow.....	0-5503		
Fuel/Water Separator.....	SF-5704	Oil Filter Full Flow.....	0-5502	(ENGINES) CAT D342C (S/N: 50B1-UP)	
Hydraulic Oil Filter.....	H-5504			Oil Filter Full Flow.....	0-5502
Hydraulic Oil Filter.....	H-5503	(ENGINES) CAT D337 (S/N: 22B1-UP)			
Oil Filter Full Flow.....	C-5510	Oil Filter Full Flow.....	0-5502	(ENGINES) CAT D-343 (S/N: 33B1-33B2566)	
				Air Filter.....	A-5506
(ENGINES) CAT D-333 (S/N: 23C1-23C739)		(ENGINES) CAT D337 (S/N: 22B862-UP)		Fuel Filter.....	F-5501
Air Filter.....	A-5504	Air Filter.....	A-5596	Oil Filter Full Flow.....	0-5503
Oil Filter Full Flow.....	0-5502	Coolant Filter.....	WC-5707		
		Fuel Filter Secondary.....	FC-5515	(ENGINES) CAT D-343 (S/N: 33B2567-UP)	
(ENGINES) CAT D-333 (S/N: 23C-UP)		Fuel Filter Secondary.....	FC-55151	Air Filter.....	A-5506
Air Filter.....	A-5504	Fuel Filter.....	FC-5516	Oil Filter Full Flow.....	0-5503
Fuel/Water Separator.....	SFC-5705	Fuel Filter.....	F-6505		
Oil Filter Full Flow.....	0-5501	Oil Filter Full Flow.....	0-5503	(ENGINES) CAT D343A (S/N: 33B1-2566-UP)	
				Air Filter.....	A-5506
(ENGINES) CAT D-333 (S/N: 58B-58B)		(ENGINES) CAT D337 (S/N: 23B1-UP)		Fuel Filter.....	F-5501
Fuel Filter.....	F-5501	Oil Filter Full Flow.....	0-5502	Oil Filter Full Flow.....	0-5503
Oil Filter Full Flow.....	0-5501				
		(ENGINES) CAT D337 (S/N: 24B1-UP)		(ENGINES) CAT D343A (S/N: 33B2567-UP)	
(ENGINES) CAT D-333 (S/N: 66D1-66D890)		Oil Filter Full Flow.....	0-5502	Air Filter.....	A-5506
Air Filter.....	A-5505			Oil Filter Full Flow.....	0-5503
Oil Filter Full Flow.....	0-5502	(ENGINES) CAT D337 (S/N: 37B-UP)			
		Air Filter.....	A-5596	(ENGINES) CAT D346 (S/N: 39J1-39J521)	
(ENGINES) CAT D-333 (S/N: 66D-66D)		Coolant Filter.....	WC-5707	Air Filter.....	A-5518
Air Filter.....	A-5505	Fuel Filter.....	FC-5516	Fuel Filter.....	F-5501
Fuel/Water Separator.....	SFC-5705	Fuel Filter Secondary.....	FC-55151	Oil Filter Full Flow.....	0-5503
Oil Filter Full Flow.....	0-5501	Fuel Filter Secondary.....	FC-5515		
		Fuel Filter.....	F-5501	(ENGINES) CAT D346 (S/N: 39J522-39J522)	
(ENGINES) CAT D333A (S/N: 59B1-UP)		Oil Filter Full Flow.....	0-5503	Air Filter.....	A-5518
Oil Filter Full Flow.....	0-5502			Fuel Filter.....	F-5501
		(ENGINES) CAT D339 (S/N: 34B1224-UP)		Oil Filter Full Flow.....	0-5502
(ENGINES) CAT D333C (S/N: 23C1-739)		Fuel Filter.....	F-5501		
Air Filter.....	A-5504	Oil Filter Full Flow.....	0-5501	(ENGINES) CAT D348 (S/N: 36J561-36J561)	
				Air Filter.....	A-5518
(ENGINES) CAT D333C (S/N: 23C740-UP)		(ENGINES) CAT D339 (S/N: 37B1-37B123)		Fuel Filter.....	F-5501
Oil Filter Full Flow.....	C-5510	Fuel Filter.....	F-5501	Oil Filter Full Flow.....	0-5502
		Oil Filter Full Flow.....	0-5501	Oil Filter Full Flow.....	0-5503
(ENGINES) CAT D333C (S/N: 66D1-8890)		(ENGINES) CAT D-342 (S/N: 31B1-31B2039)		(ENGINES) CAT D348 (S/N: 38J1-38J192)	
Air Filter.....	A-5505			Air Filter.....	A-5518
				Fuel Filter.....	F-5501
				Oil Filter Full Flow.....	0-5503

MODEL/APPLICATION	SAKURA NO	MODEL/APPLICATION	SAKURA NO	MODEL/APPLICATION	SAKURA NO
CATERPILLAR		CATERPILLAR		CATERPILLAR	
(ENGINES) CAT D348 (S/N: 38J1-38J192)		Fuel Filter..... F-5501		Air Filter..... A-5506	
		Oil Filter Full Flow..... 0-5503		Fuel Filter..... F-5501	
				Oil Filter Full Flow..... 0-5503	
(ENGINES) CAT D-349 (S/N: 61P-61P)		(ENGINES) CAT D353C (S/N: 47B1-408)		(ENGINES) CAT D-379 (S/N: 69B1-69B211)	
Air Filter..... A-5518		Air Filter..... A-5518		Air Filter..... A-5506	
Air Filter Set..... A-7912-S		Fuel Filter..... F-5501		Fuel Filter..... F-5501	
Air Filter Primary..... A-7912		Oil Filter Full Flow..... 0-5503		Oil Filter Full Flow..... 0-5503	
Air Filter Secondary..... A-7915		(ENGINES) CAT D353C (S/N: 47B1710-1779)		(ENGINES) CAT D-379 (S/N: 69B188-69B1226)	
Fuel Filter..... F-5501		Oil Filter Full Flow..... 0-5503		Air Filter..... A-5518	
Oil Filter Full Flow..... C-5505		(ENGINES) CAT D353C (S/N: 47B409-1709)		Fuel Filter..... F-5501	
Oil Filter Full Flow..... 0-5501		Fuel Filter..... F-5501		Oil Filter Full Flow..... 0-5503	
(ENGINES) CAT D-349 (S/N: 62P1-UP)		Oil Filter Full Flow..... 0-5503		(ENGINES) CAT D-379 (S/N: 69B227-69B227)	
Air Filter..... A-5518		(ENGINES) CAT D353D (S/N: 46B1558-2436)		Air Filter..... A-5518	
Fuel Filter..... F-5501		Air Filter..... A-5517		Fuel Filter..... F-5501	
Oil Filter Full Flow..... 0-5502		Oil Filter Full Flow..... 0-5503		Oil Filter Full Flow..... 0-5502	
(ENGINES) CAT D-349 (S/N: 67P1-UP)		(ENGINES) CAT D353D (S/N: 46B670-808)		(ENGINES) CAT D-379 (S/N: 76B1-79B415)	
Air Filter..... A-5518		Fuel Filter..... F-5501		Air Filter..... A-5518	
Fuel Filter..... F-5501		Oil Filter Full Flow..... 0-5503		Fuel Filter..... F-5501	
Oil Filter Full Flow..... 0-5502		(ENGINES) CAT D353D (S/N: 46B809-1557)		Oil Filter Full Flow..... 0-5503	
(ENGINES) CAT D-353 (S/N: 46B1-46B808)		Oil Filter Full Flow..... 0-5503		(ENGINES) CAT D379A (S/N: 68B1-629)	
Fuel Filter..... F-5501		(ENGINES) CAT D353E (S/N: 46B2437-3012)		Air Filter..... A-5506	
Oil Filter Full Flow..... 0-5503		Air Filter..... A-5517		Fuel Filter..... F-5501	
(ENGINES) CAT D-353 (S/N: 46B1558-46B3012)		Oil Filter Full Flow..... 0-5503		Oil Filter Full Flow..... 0-5503	
Air Filter..... A-5517		(ENGINES) CAT D353E (S/N: 46B3013-UP)		(ENGINES) CAT D379A (S/N: 68B630-1615)	
Fuel Filter..... F-5501		Air Filter..... A-5517		Air Filter..... A-5518	
Fuel/Water Separator..... SFC-5705		Oil Filter Full Flow..... 0-5503		Fuel Filter..... F-5501	
Oil Filter Full Flow..... 0-5503		(ENGINES) CAT D353E (S/N: 47B1780-UP)		Oil Filter Full Flow..... 0-5503	
(ENGINES) CAT D-353 (S/N: 46B3013-46B3013)		Air Filter..... A-5517		(ENGINES) CAT D379A (S/N: 69B1-187)	
Air Filter..... A-5517		Oil Filter Full Flow..... 0-5503		Air Filter..... A-5506	
Fuel/Water Separator..... SFC-5705		(ENGINES) CAT D353E (S/N: 77B1-321)		Fuel Filter..... F-5501	
Oil Filter Full Flow..... 0-5503		Air Filter..... A-5517		Oil Filter Full Flow..... 0-5503	
(ENGINES) CAT D-353 (S/N: 47B1-47B408)		Oil Filter Full Flow..... 0-5503		(ENGINES) CAT D379B (S/N: 34Z1-UP)	
Air Filter..... A-5518		(ENGINES) CAT D364		Fuel Filter..... F-5501	
Fuel Filter..... F-5501		Oil Filter Full Flow..... 0-7902		Oil Filter Full Flow..... 0-5502	
Oil Filter Full Flow..... 0-5503		(ENGINES) CAT D-375 (S/N: 16B1-16B285)		(ENGINES) CAT D379B (S/N: 68B1616-2539)	
(ENGINES) CAT D-353 (S/N: 47B1710-47B1779)		Oil Filter Full Flow..... 0-5503		Air Filter..... A-5518	
Fuel/Water Separator..... SFC-5705		(ENGINES) CAT D-375 (S/N: 16B86-UP)		Fuel Filter..... F-5501	
Oil Filter Full Flow..... 0-5503		Oil Filter Full Flow..... 0-5503		Oil Filter Full Flow..... 0-5503	
(ENGINES) CAT D-353 (S/N: 47B1780-UP)		(ENGINES) CAT D375D		(ENGINES) CAT D379B (S/N: 68B2540-UP)	
Air Filter..... A-5517		Oil Filter Full Flow..... 0-7902		Air Filter..... A-5518	
Fuel/Water Separator..... SFC-5705		(ENGINES) CAT D-379 (S/N: 69B1-69B187)		Fuel Filter..... F-5501	
Oil Filter Full Flow..... 0-5503					
(ENGINES) CAT D-353 (S/N: 77B1-77B321)					
Air Filter..... A-5517					
Oil Filter Full Flow..... 0-5503					
(ENGINES) CAT D353C (S/N: 46B1-669)					

Sakura Filter

ENGINE APPLICATION

MODEL/APPLICATION	SAKURA NO	MODEL/APPLICATION	SAKURA NO	MODEL/APPLICATION	SAKURA NO
CATERPILLAR		CATERPILLAR		CATERPILLAR	
(ENGINES) CAT D379B (S/N: 68B2540-UP)		(ENGINES) CAT D398A (S/N: 66B1-635)		Fuel Filter.....	F-5501
Oil Filter Full Flow.....	0-5502	Air Filter.....	A-5506	Oil Filter Full Flow.....	0-5502
(ENGINES) CAT D379B (S/N: 69B1227-UP)		(ENGINES) CAT D398A (S/N: 66B636-2048)		(ENGINES) CAT D399 (S/N: 35B688-UP)	
Air Filter.....	A-5518	Air Filter.....	A-5518	Air Filter.....	A-5518
Fuel Filter.....	F-5501	Fuel Filter.....	F-5501	Fuel Filter.....	F-5501
Oil Filter Full Flow.....	0-5502	Oil Filter Full Flow.....	0-5503	Oil Filter Full Flow.....	0-5502
(ENGINES) CAT D379B (S/N: 69B824-1226)		(ENGINES) CAT D398A (S/N: 67B1-211)		(ENGINES) CAT D399 (S/N: 36Z1-UP)	
Air Filter.....	A-5518	Air Filter.....	A-5517	Fuel Filter.....	F-5501
Fuel Filter.....	F-5501	Fuel Filter.....	F-5501	Oil Filter Full Flow.....	0-5502
Oil Filter Full Flow.....	0-5503	Oil Filter Full Flow.....	0-5503	(ENGINES) CAT D399 (S/N: 91B1-386)	
(ENGINES) CAT D379B (S/N: 76B1-415)		(ENGINES) CAT D398A (S/N: 67B212-919)		Air Filter.....	A-5518
Air Filter.....	A-5518	Air Filter.....	A-5518	Fuel Filter.....	F-5501
Fuel Filter.....	F-5501	Fuel Filter.....	F-5501	Oil Filter Full Flow.....	0-5503
Oil Filter Full Flow.....	0-5503	Oil Filter Full Flow.....	0-5503	(ENGINES) CAT D399 (S/N: 91B387-UP)	
(ENGINES) CAT D386		(ENGINES) CAT D398B (S/N: 35Z1-UP)		Air Filter.....	A-5518
Oil Filter Full Flow.....	0-7902	Fuel Filter.....	F-5501	Fuel Filter.....	F-5501
(ENGINES) CAT D-397 (S/N: 10B-10B)		Oil Filter Full Flow.....	0-5502	Oil Filter Full Flow.....	0-5502
Oil Filter Full Flow.....	0-5503	(ENGINES) CAT D398B (S/N: 66B2049-3560)		(ENGINES) CAT D4400	
(ENGINES) CAT D-397 (S/N: 41B-41B)		Air Filter.....	A-5518	Oil Filter Full Flow.....	0-5502
Oil Filter Full Flow.....	0-5503	Fuel Filter.....	F-5501	(ENGINES) CAT D4600	
(ENGINES) CAT D397D		Oil Filter Full Flow.....	0-5503	Oil Filter Full Flow.....	0-5404
Oil Filter Full Flow.....	0-7902	(ENGINES) CAT D398B (S/N: 66B3561-UP)		(ENGINES) CAT D8800	
(ENGINES) CAT D398 (S/N: 66B1-66B635)		Air Filter.....	A-5518	Oil Filter Full Flow.....	0-5502
Air Filter.....	A-5506	Fuel Filter.....	F-5501	(ENGINES) CAT G3306	
Fuel Filter.....	F-5501	Oil Filter Full Flow.....	0-5502	Air Filter.....	A-5505
Oil Filter Full Flow.....	0-5503	(ENGINES) CAT D398B (S/N: 67B1391-UP)		Coolant Filter.....	WC-5707
(ENGINES) CAT D398 (S/N: 66B3561-66B3561)		Air Filter.....	A-5518	Coolant Filter.....	WC-5705
Air Filter.....	A-5518	Fuel Filter.....	F-5501	Coolant Filter.....	WC-5708
Fuel Filter.....	F-5501	Oil Filter Full Flow.....	0-5502	Oil Filter Full Flow.....	C-5510
Oil Filter Full Flow.....	0-5502	(ENGINES) CAT D398B (S/N: 67B920-1390)		Oil Filter Full Flow.....	C-5516
Oil Filter Full Flow.....	0-5501	Air Filter.....	A-5518	Oil Filter Full Flow.....	C-5522
(ENGINES) CAT D398 (S/N: 67B1391-UP)		Fuel Filter.....	F-5501	(ENGINES) CAT G333 SERIES	
Air Filter.....	A-5518	Oil Filter Full Flow.....	0-5503	Air Filter.....	A-5505
Fuel Filter.....	F-5501	(ENGINES) CAT D399 (S/N: 35B1-35B687)		Air Filter.....	A-5504
Oil Filter Full Flow.....	0-5502	Air Filter.....	A-5518	Oil Filter Full Flow.....	0-5501
(ENGINES) CAT D398 (S/N: 67B1-67B211)		Fuel Filter.....	F-5501	(ENGINES) CAT G3406	
Air Filter.....	A-5517	Oil Filter Full Flow.....	0-5503	Air Filter Secondary.....	A-5529
Fuel Filter.....	F-5501	(ENGINES) CAT D399 (S/N: 35B1-687)		Air Filter Set.....	A-5521-S
Oil Filter Full Flow.....	0-5502	Air Filter.....	A-5518	Air Filter Primary.....	A-5521
(ENGINES) CAT D398 (S/N: 67B212-67B1390)		Fuel Filter.....	F-5501	Oil Filter Full Flow.....	C-5516
Air Filter.....	A-5517	Oil Filter Full Flow.....	0-5503	(ENGINES) CAT G3408	
Fuel Filter.....	F-5501	(ENGINES) CAT D399 (S/N: 35B688-35B688)		Air Filter Primary.....	A-5521
Oil Filter Full Flow.....	0-5503	Air Filter.....	A-5518	Air Filter Set.....	A-5521-S
(ENGINES) CAT D398 (S/N: 67B212-67B1390)		Fuel Filter.....	F-5501	Air Filter Secondary.....	A-5552
Air Filter.....	A-5518	Oil Filter Full Flow.....	0-5503	Oil Filter Full Flow.....	C-5516
Fuel Filter.....	F-5501	(ENGINES) CAT D399 (S/N: 35B688-35B688)		(ENGINES) CAT G3408	
Oil Filter Full Flow.....	0-5503	Air Filter.....	A-5518	Air Filter Primary.....	A-5521
(ENGINES) CAT D398 (S/N: 67B212-67B1390)		Fuel Filter.....	F-5501	Air Filter Set.....	A-5521-S
Air Filter.....	A-5518	Oil Filter Full Flow.....	0-5503	Air Filter Secondary.....	A-5552
Fuel Filter.....	F-5501	(ENGINES) CAT D399 (S/N: 35B688-35B688)		Oil Filter Full Flow.....	C-5516
Oil Filter Full Flow.....	0-5503	Air Filter.....	A-5518		

Sakura Filter

ENGINE APPLICATION

MODEL/APPLICATION	SAKURA NO	MODEL/APPLICATION	SAKURA NO	MODEL/APPLICATION	SAKURA NO
CATERPILLAR		CATERPILLAR		CATERPILLAR	
(ENGINES) CAT G3412		Air Filter Set..... A-5531-S	A-5531-S	Fuel Filter.....	F-5506
Air Filter Set.....	A-5531-S	Air Filter Primary.....	A-5531	(ENGINES) CAT 3512 (S/N: 3MS-ON)	
Air Filter Primary.....	A-5531	Oil Filter Full Flow.....	0-5504	Fuel Filter.....	F-5506
Fuel Filter.....	FC-5509	(ENGINES) CAT G3516 (S/N: 5PN1-UP)		(GENERATORS) CAT C1.5 (S/N: E1M1-UP)	
Oil Filter Full Flow.....	C-5516	Oil Filter Full Flow.....	0-5504	Oil Filter Full Flow.....	C-1123
(ENGINES) CAT G342		(ENGINES) CAT G3516TA (S/N: 4EK1-UP)		PF-290B (COMPACTORS) CAT 7BJ1-UP , 2011	
Air Filter.....	A-5506	Air Filter Primary.....	A-5531	Air Filter Set.....	A-56731-S
Oil Filter Full Flow.....	0-5501	Air Filter Set.....	A-5531-S	Air Filter Secondary.....	A-56741
(ENGINES) CAT G342C (S/N: 71B1-UP)		Oil Filter Full Flow.....	0-5504	Air Filter Primary.....	A-56731
Oil Filter Full Flow.....	0-5502	(ENGINES) CAT G3516TA (S/N: 8JZ1-171-UP)		PF-290B (COMPACTORS) CAT 3054	
(ENGINES) CAT G342F		Air Filter Set.....	A-5531-S	Air Filter Secondary.....	A-5540
Air Filter.....	A-5506	Air Filter Primary.....	A-5531	Hydraulic Oil Filter.....	HC-5504
Oil Filter Full Flow.....	0-5501	Oil Filter Full Flow.....	0-5504	Oil Filter Full Flow.....	C-5101
(ENGINES) CAT G343		(ENGINES) CAT G353		PF-300B (COMPACTORS) CAT 7BJ1-UP , 2011	
Air Filter.....	A-5506	Air Filter.....	A-5506	Air Filter Secondary.....	A-56741
Air Filter.....	A-5505	Oil Filter Full Flow.....	0-5503	Air Filter Set.....	A-56731-S
Oil Filter Full Flow.....	0-5503	(ENGINES) CAT G353D		Air Filter Primary.....	A-56731
(ENGINES) CAT G349		Air Filter.....	A-5506	PF-300B (COMPACTORS) CAT (S/N: 5HK24000-UP)	
Air Filter.....	A-5505	Oil Filter Full Flow.....	0-5503	Oil Filter Full Flow.....	C-5102
Oil Filter Full Flow.....	0-5501	(ENGINES) CAT G353D (S/N: 64B1-UP)		Oil Filter Full Flow.....	C-5101
(ENGINES) CAT G3508 (S/N: 2JF1 & UP)		Oil Filter Full Flow.....	0-5503	PF-300B (COMPACTORS) CAT (S/N: 7BJ1-UP)	
Air Filter Primary.....	A-5531	(ENGINES) CAT G379		Air Filter Set.....	A-5675-S
Air Filter Set.....	A-5531-S	Air Filter.....	A-5506	Air Filter Primary.....	A-5673
Oil Filter Full Flow.....	0-5504	Oil Filter Full Flow.....	0-5503	Air Filter Secondary.....	A-8670
(ENGINES) CAT G3508TA		Oil Filter Full Flow.....	0-5501	Oil Filter Full Flow.....	C-5101
Air Filter Set.....	A-5531-S	(ENGINES) CAT G398		Oil Filter Full Flow.....	C-5102
Air Filter Primary.....	A-5531	Air Filter.....	A-5506	Oil Filter Full Flow.....	C-5101
Oil Filter Full Flow.....	0-5504	Air Filter.....	A-5517	PF-300B (COMPACTORS) S/N: 6HM1-82-UP	
(ENGINES) CAT G3512 (S/N: 4KC320 & UP)		Air Filter.....	A-5518	Air Filter Set.....	A-5541M-S
Air Filter Primary.....	A-5531	Oil Filter Full Flow.....	0-5501	Air Filter Secondary.....	A-5540
Air Filter Set.....	A-5531-S	Oil Filter Full Flow.....	0-5503	Air Filter Primary.....	A-5541M
Oil Filter Full Flow.....	0-5504	(ENGINES) CAT G399		Air Filter Primary.....	A-5541
(ENGINES) CAT G3512TA (S/N: 4K320 & UP)		Air Filter.....	A-5517	Air Filter Primary.....	A-76231
Air Filter Set.....	A-5531-S	Oil Filter Full Flow.....	0-5503	PF-300B (COMPACTORS) S/N: 6HM196-412-UP	
Air Filter Primary.....	A-5531	Oil Filter Full Flow.....	0-5501	Air Filter Primary.....	A-5541
Oil Filter Full Flow.....	0-5504	(ENGINES) CAT PM3516		Air Filter Primary.....	A-5541M
(ENGINES) CAT G3516		Air Filter.....	A-5551	Air Filter Secondary.....	A-5540
Air Filter Primary.....	A-5531	Air Filter Set.....	A-5551-S	Air Filter Set.....	A-5541M-S
Air Filter Set.....	A-5531-S	Oil Filter Full Flow.....	0-5504	Air Filter Primary.....	A-76231
Air Filter Set.....	A-5521-S	(ENGINES) CAT 3406E (S/N: 5EK1)		PF-300B (COMPACTORS) S/N: 6HM413-UP	
Air Filter Primary.....	A-5521	Fuel Filter.....	FC-5509	Air Filter Set.....	A-5541M-S
Air Filter Secondary.....	A-5552	Fuel/Water Separator.....	SFC-5505	Air Filter Primary.....	A-76231
Oil Filter Full Flow.....	0-5504	(ENGINES) CAT 3508 (S/N: 5XM-ON)		Air Filter Set.....	A-5541M-S
(ENGINES) CAT G3516 (S/N: 4EK1-UP)		(ENGINES) CAT 3508 (S/N: 5XM-ON)		Air Filter Secondary.....	A-5540
Air Filter Set.....	A-5531-S	(ENGINES) CAT 3508 (S/N: 5XM-ON)		Air Filter Primary.....	A-5541M
Air Filter Primary.....	A-5531	(ENGINES) CAT 3508 (S/N: 5XM-ON)		Air Filter Primary.....	A-5541
Fuel Filter.....	FC-5509	(ENGINES) CAT 3508 (S/N: 5XM-ON)			
Oil Filter Full Flow.....	0-5504				

Sakura Filter

ENGINE APPLICATION

MODEL/APPLICATION	SAKURA NO	MODEL/APPLICATION	SAKURA NO	MODEL/APPLICATION	SAKURA NO
CATERPILLAR		CATERPILLAR		CATERPILLAR	
PF-300B (COMPACTORS) S/N: 6HM413-UP Air Filter Primary..... A-76231		Hydraulic Oil Filter..... H-55270 Hydraulic Oil Filter..... HC-5504 Oil Filter Full Flow..... C-7906		PR-1000C (COLD PLANERS) CAT (S/N: 73W1-UP) Fuel Filter..... FC-5509	
PF-300B (COMPACTORS) S/N: 6HM83-195-UP Air Filter Primary..... A-5541 Air Filter Primary..... A-5541M Air Filter Secondary..... A-5540 Air Filter Set..... A-5541M-S Air Filter Primary..... A-76231 Hydraulic Oil Filter..... HC-5504		PM3512 (GENERATORS) PM3512 Power Module Air Filter Set..... A-4403-S Air Filter..... A-4403		PR-1000C (COLD PLANERS) CAT (S/N: 79V1-UP) Fuel Filter Secondary..... FC-5507 Oil Filter Full Flow..... C-5505	
PF-300 (COMPACTORS) S/N: 7WD1-UP Fuel Filter..... FC-5704 Hydraulic Oil Filter..... HC-7913		PM3516 (GENERATORS) PM3516 Power Module Air Filter..... A-4403 Air Filter Set..... A-4403-S		PR-1000C (COLD PLANERS) S/N: 03Z4000-7211-UP Oil Filter Full Flow..... C-5505	
PF-300C (COMPACTORS) CAT S/N: CRS2317-UP Air Filter Set..... A-5541M-S Air Filter Primary..... A-5541 Air Filter Primary..... A-5541M Air Filter Secondary..... A-5540 Air Filter Primary..... A-76231 Oil Filter Full Flow..... C-5102		PM-465 (COLD PLANERS) CAT S/N: 41Z4926-UP , 2004-UP Air Filter Secondary..... A-5563 Air Filter Primary..... A-5564 Air Filter Set..... A-5565-S Fuel Filter..... FC-5509 Hydraulic Oil Filter..... HC-5504 Hydraulic Oil Filter..... HC-5503 Hydraulic Oil Filter..... HC-5506 Hydraulic Oil Filter..... HC-5512		PR-1000C (COLD PLANERS) S/N: 03Z7212-UP Oil Filter Full Flow..... C-5505	
PF-300C (COMPACTORS) CAT S/N: PFB1-UP Air Filter Primary..... A-76231 Air Filter Secondary..... A-5540 Air Filter Primary..... A-5541M Air Filter Primary..... A-5541 Air Filter Set..... A-5541M-S Oil Filter Full Flow..... C-5102		PM-465 (COLD PLANERS) CAT S/N: 5ZS146-UP , 2004-UP Air Filter Set..... A-5565-S Air Filter Primary..... A-5564 Air Filter Secondary..... A-5563 Fuel Filter..... FC-5509 Hydraulic Oil Filter..... HC-5512 Hydraulic Oil Filter..... HC-5506 Hydraulic Oil Filter..... HC-5503 Hydraulic Oil Filter..... HC-5504		PR-1000C (COLD PLANERS) S/N: 38S13236-UP Air Filter Set..... A-5555-S Air Filter Primary..... A-5555 Air Filter Secondary..... A-5556	
PF-300C (COMPACTORS) CAT S/N: PFB1-UP Air Filter Primary..... A-76231 Air Filter Secondary..... A-5540 Air Filter Primary..... A-5541M Air Filter Primary..... A-5541 Air Filter Set..... A-5541M-S Oil Filter Full Flow..... C-5102		PM-565 (COLD PLANERS) S/N: 3TK113-UP Air Filter Primary..... A-5532 Air Filter Set..... A-5532-S Air Filter Set..... A-5565-S Air Filter Primary..... A-5564 Air Filter Secondary..... A-5563 Fuel Filter..... FC-5509 Hydraulic Oil Filter..... HC-5512 Hydraulic Oil Filter..... HC-5506 Hydraulic Oil Filter..... HC-5503 Hydraulic Oil Filter..... HC-5504		PR-1000C (COLD PLANERS) S/N: 5XC1-137-UP Air Filter Primary..... A-2210 Air Filter Set..... A-7912-S Air Filter Primary..... A-7912 Air Filter Secondary..... A-7915	
PM-200 (COLD PLANERS) CAT S/N: P1C1-UP Fuel Filter..... FC-5510 Fuel Filter..... FC-5517 Oil Filter Full Flow..... C-7906		PM-565 (COLD PLANERS) CAT S/N: 3TK113-UP Air Filter Primary..... A-5532 Air Filter Set..... A-5532-S Air Filter Set..... A-5565-S Air Filter Primary..... A-5564 Air Filter Secondary..... A-5563 Fuel Filter..... FC-5509 Oil Filter Full Flow..... C-5516		PR-1000C (COLD PLANERS) S/N: 5XC138-138-UP Air Filter Secondary..... A-7915 Air Filter Primary..... A-7912 Air Filter Primary..... A-6113 Air Filter Secondary..... A-5408 Air Filter Set..... A-7912-S	
PM-200 (COLD PLANERS) CAT S/N: RHX1-UP Fuel Filter..... FC-5517 Fuel Filter..... FC-5510 Oil Filter Full Flow..... C-7906		PM-565B (COLD PLANERS) CAT 3408E HEUI Air Filter Secondary..... A-5563 Air Filter Primary..... A-5564 Air Filter Set..... A-5565-S Coolant Filter..... WC-5707 Fuel Filter..... FC-5509 Hydraulic Oil Filter..... H-55270 Hydraulic Oil Filter..... H-5504 Hydraulic Oil Filter..... HC-5504 Oil Filter Full Flow..... C-5516		PR-1000C (COLD PLANERS) S/N: 5XC139-142-UP Air Filter Set..... A-7912-S Air Filter Secondary..... A-5408 Air Filter Primary..... A-6113 Air Filter Primary..... A-7912 Air Filter Secondary..... A-7915	
PM-201 (COLD PLANERS) CAT S/N: PNM1-UP Air Filter Secondary..... A-5715 Fuel Filter..... FC-5517 Fuel Filter..... FC-5510 Hydraulic Oil Filter..... HC-5504 Hydraulic Oil Filter..... H-55270 Oil Filter Full Flow..... C-7906		PM-800 (COLD PLANERS) Fuel Filter..... FC-5519 Hydraulic Oil Filter..... H-5517 Oil Filter Full Flow..... C-5516		PR-1000C (COLD PLANERS) S/N: 5XC143-143-UP Air Filter Secondary..... A-7915 Air Filter Primary..... A-7912 Air Filter Primary..... A-6113 Air Filter Secondary..... A-5408 Air Filter Set..... A-7912-S	
PM-201 (COLD PLANERS) CAT S/N: RHX1-UP Air Filter Secondary..... A-5715 Fuel Filter..... FC-5510 Fuel Filter..... FC-5517				PR-1000C (COLD PLANERS) S/N: 5XC144-147-UP Air Filter Set..... A-7912-S Air Filter Secondary..... A-5408 Air Filter Primary..... A-6113 Air Filter Primary..... A-7912 Air Filter Secondary..... A-7915	
				PR-1000C (COLD PLANERS) S/N: 5XC148-UP Air Filter Secondary..... A-7915 Air Filter Primary..... A-7912	

Sakura Filter

ENGINE APPLICATION

MODEL/APPLICATION	SAKURA NO	MODEL/APPLICATION	SAKURA NO	MODEL/APPLICATION	SAKURA NO
CATERPILLAR		CATERPILLAR		CATERPILLAR	
PR-100C (COLD PLANERS) S/N: 5XC148-UP		Fuel Filter.....	FC-5509	Air Filter Primary.....	A-56731
Air Filter Primary.....	A-6113	Fuel Filter.....	FC-5519	PS-200B (COMPACTORS) CAT 3054	
Air Filter Secondary.....	A-5408	Oil Filter Full Flow.....	C-5516	Air Filter Secondary.....	A-5540
Air Filter Set.....	A-7912-S	PR-75 (COLD PLANERS) S/N: 6BD1-UP		Air Filter Primary.....	A-5541M
PR-100 (COLD PLANERS)		Oil Filter Full Flow.....	C-5101	Air Filter Primary.....	A-5541
Air Filter Set.....	AS-5656-S	PR-750C (COLD PLANERS) S/N: 7CK1-UP		Air Filter Set.....	A-5541M-S
Air Filter Primary.....	AS-7805	Fuel Filter.....	FC-5509	Air Filter Primary.....	A-76231
Oil Filter Full Flow.....	C-5505	PS-150B (COMPACTORS) S/N: 3XR1-69		Hydraulic Oil Filter.....	HC-5504
PR-1000 (COLD PLANERS) S/N: 5XC1-137		Air Filter Secondary.....	A-5540	Oil Filter Full Flow.....	C-5102
Fuel Filter Secondary.....	FC-5507	Air Filter Primary.....	A-5541M	PS-300B (COMPACTORS) CAT 7BJ1-UP , 2011	
Fuel Filter.....	FC-5519	Air Filter Primary.....	A-5541	Air Filter Primary.....	A-56731
Oil Filter Full Flow.....	C-5505	Air Filter Set.....	A-5541M-S	Air Filter Secondary.....	A-56741
Oil Filter Full Flow.....	C-5516	Air Filter Primary.....	A-76231	Air Filter Set.....	A-56731-S
PR-100DC (COLD PLANERS)		Hydraulic Oil Filter.....	HC-5504	PS-300B (COMPACTORS) CAT 3054DIT	
Air Filter Primary.....	AS-7805	Oil Filter Full Flow.....	C-5101	Air Filter Set.....	A-5541M-S
Air Filter Set.....	AS-5656-S	PS-150C (COMPACTORS) CAT S/N: CRS1600-UP		Air Filter Primary.....	A-5541
Oil Filter Full Flow.....	C-5505	Air Filter Set.....	A-5541M-S	Air Filter Secondary.....	A-5540
PR-105 (COLD PLANERS) S/N: 5NC1-UP		Air Filter Primary.....	A-5541	Air Filter Primary.....	A-5541M
Fuel Filter.....	FC-5503	Air Filter Primary.....	A-5541M	Air Filter Primary.....	A-76231
Hydraulic Oil Filter.....	H-79411	Air Filter Secondary.....	A-5540	Oil Filter Full Flow.....	C-5101
Hydraulic Oil Filter.....	H-51170	Air Filter Primary.....	A-76231	PS-300B (COMPACTORS) CAT 3054T (S/N: 4NP81-UP)	
Oil Filter Full Flow.....	C-5504	Air Filter Primary.....	A-8504	Air Filter Primary.....	A-76231
PR-275 (COLD PLANERS) S/N: 6RC1-UP		Hydraulic Oil Filter.....	HC-5504	Air Filter Secondary.....	A-5540
Air Filter.....	A-5505	Oil Filter Full Flow.....	C-5102	Air Filter Primary.....	A-5541
Oil Filter Full Flow.....	C-5510	PS-150C (COMPACTORS) CAT S/N: FPS1-UP		Air Filter Set.....	A-5541M-S
PR-450 (COLD PLANERS) S/N: 7DC204-UP		Air Filter Primary.....	A-8504	Hydraulic Oil Filter.....	HC-5504
Fuel Filter.....	FC-5502	Air Filter Primary.....	A-76231	Oil Filter Full Flow.....	C-5102
Fuel Filter.....	FC-5509	Air Filter Secondary.....	A-5540	PS-300B (COMPACTORS) CAT 3054T (S/N: 4PN1-UP)	
Oil Filter Full Flow.....	C-5516	Air Filter Primary.....	A-5541M	Oil Filter Full Flow.....	C-5101
PR-450C (COLD PLANERS) CAT S/N: 48W34000-UP		Air Filter Primary.....	A-5541	PS-300B (COMPACTORS) CAT 3054T (S/N: 6HM1-UP)	
Fuel Filter.....	FC-5509	Air Filter Set.....	A-5541M-S	Air Filter Set.....	A-5541M-S
Oil Filter Full Flow.....	C-5516	Hydraulic Oil Filter.....	HC-5504	Air Filter Primary.....	A-5541
PR-450C (COLD PLANERS) CAT S/N: 67U14870-UP		Oil Filter Full Flow.....	C-5102	Air Filter Secondary.....	A-5540
Fuel Filter.....	FC-5509	PS-150C (COMPACTORS) w/3054T Eng.		Air Filter Primary.....	A-5541M
Oil Filter Full Flow.....	C-5516	Fuel/Water Separator.....	SFC-43040	Air Filter Primary.....	A-76231
PR-450C (COLD PLANERS) S/N: 7PJ1-55-UP		PS110 (COMPACTORS) S/N: 7MD1-UP		Hydraulic Oil Filter.....	HC-5504
Air Filter Secondary.....	A-6902	Fuel Filter.....	FC-5103	Oil Filter Full Flow.....	C-5102
Air Filter Primary.....	A-6903	Oil Filter Full Flow.....	C-5101	PS-300C (COMPACTORS) CAT S/N: CRS2317-UP	
Air Filter Set.....	A-6903-S	PS-130 (COMPACTORS)		Air Filter Secondary.....	A-5540
PR-450C (COLD PLANERS) S/N: 7PJ56-UP		Fuel Filter.....	FC-5103	Air Filter Primary.....	A-5541M
Air Filter Set.....	A-6903-S	Oil Filter Full Flow.....	C-5101	Air Filter Primary.....	A-5541
Air Filter Primary.....	A-6903	PS-180 (COMPACTORS)		Air Filter Set.....	A-5541M-S
Air Filter Secondary.....	A-6902	Fuel Filter.....	FC-5103	Air Filter Primary.....	A-76231
PR-750B (COLD PLANERS) S/N: 8AC1-UP		Oil Filter Full Flow.....	C-5101	Oil Filter Full Flow.....	C-5102
Air Filter Set.....	A-6903-S	PS-200B (COMPACTORS) CAT 7BJ1-UP , 2011		PS-300C (COMPACTORS) CAT S/N: PFS1-UP	
Air Filter Primary.....	A-6903	Air Filter Set.....	A-56731-S	Air Filter Primary.....	A-76231
Air Filter Secondary.....	A-6902	Air Filter Secondary.....	A-56741	Air Filter Set.....	A-5541M-S
				Air Filter Primary.....	A-5541
				Air Filter Primary.....	A-5541M

MODEL/APPLICATION	SAKURA NO	MODEL/APPLICATION	SAKURA NO	MODEL/APPLICATION	SAKURA NO
CATERPILLAR		CATERPILLAR		CATERPILLAR	
PS-300C (COMPACTORS) CAT S/N: PFS1-UP		Fuel Filter.....	FC-5704	Air Filter Set.....	A-5578-S
Air Filter Secondary.....	A-5540	Hydraulic Oil Filter.....	HC-7913	Air Filter Primary.....	A-5577
Oil Filter Full Flow.....	C-5102			Air Filter Secondary.....	A-5576
PS-300C (COMPACTORS) w/3054C Eng.		PS-300 (COMPACTORS) S/N: 7TD1-UP		Fuel Filter.....	FC-5103
Fuel/Water Separator.....	SFC-43040	Hydraulic Oil Filter.....	HC-7913	Hydraulic Oil Filter Transmission...	HC-5501
PS-360B (COMPACTORS) CAT 7BJ1-UP , 2011		PS-300A (COMPACTORS)		Hydraulic Oil Filter.....	H-5517
Air Filter Primary.....	A-56731	Fuel Filter.....	F-5505	Oil Filter Full Flow.....	C-5101
Air Filter Set.....	A-56731-S	Oil Filter Full Flow.....	C-5510		
Air Filter Secondary.....	A-56741			R60 THRU R80 (FORKLIFTS) PERKINS 4.236 (S/N: 32A-UP)	
PS-360B (COMPACTORS) CAT 3054T		PS-500 (COMPACTORS) S/N: 7XD1-UP		Air Filter Set.....	A-5579-S
Oil Filter Full Flow.....	C-5102	Air Filter Primary.....	A-5509	Air Filter Set.....	A-5578-S
PS-360B (COMPACTORS) CAT 7BJ1-UP		Air Filter Set.....	A-5522-S	Air Filter Primary.....	A-5577
Air Filter Primary.....	A-56731	Air Filter Primary.....	A-5549M	Air Filter Secondary.....	A-5576
Air Filter Secondary.....	A-56741	Air Filter Primary.....	A-5549	Hydraulic Oil Filter.....	H-5517
Air Filter Set.....	A-56731-S	Air Filter Set.....	A-5549M-S	Hydraulic Oil Filter Transmission...	HC-5501
PS-360C (COMPACTORS) CAT CR51-UP , 2011		Air Filter Secondary.....	A-5550	Oil Filter Full Flow.....	C-5101
Air Filter Secondary.....	A-56741	Fuel Filter Secondary.....	FC-5507		
Air Filter Primary.....	A-56731	Oil Filter Full Flow.....	C-5519	R60 THRU R80 (FORKLIFTS) PERKINS 4.236 (S/N: 38A-38A)	
Air Filter Set.....	A-56731-S			Air Filter Secondary.....	A-5576
PS-360C (COMPACTORS) CAT G41-UP , 2011		R40 (FORKLIFTS) PERKINS 4.236		Air Filter Primary.....	A-5577
Air Filter Set.....	A-56731-S	Air Filter Set.....	A-5579-S	Air Filter Set.....	A-5578-S
Air Filter Primary.....	A-56731	Air Filter Set.....	A-5578-S	Air Filter Set.....	A-5579-S
Air Filter Secondary.....	A-56741	Air Filter Primary.....	A-5577	Fuel Filter.....	FC-5103
PS-360C (COMPACTORS) CAT S/N: CRS2700-UP		Air Filter Secondary.....	A-5576	Hydraulic Oil Filter.....	H-5517
Air Filter Secondary.....	A-8670	Air Filter Primary.....	A-5577	Hydraulic Oil Filter Transmission...	HC-5501
Air Filter Primary.....	A-5673	Hydraulic Oil Filter.....	H-5517	Oil Filter Full Flow.....	C-5101
Air Filter Set.....	A-5675-S	Hydraulic Oil Filter Transmission...	HC-5501		
Hydraulic Oil Filter.....	HC-5504	Oil Filter Full Flow.....	C-5101	R60 THRU R80 (FORKLIFTS) PERKINS 4.236 DIESEL (S/N: 1KK-UP)	
Oil Filter Full Flow.....	C-5102			Air Filter Secondary.....	A-5576
PS-360C (COMPACTORS) CAT S/N: G4D1-UP		R40 THRU RC60 (FORKLIFTS) PERKINS 4.236 (S/N: 16A-UP)		Air Filter Primary.....	A-5577
Air Filter Set.....	A-5675-S	Air Filter Set.....	A-5578-S	Air Filter Set.....	A-5578-S
Air Filter Primary.....	A-5673	Air Filter Set.....	A-5579-S	Air Filter Set.....	A-5579-S
Air Filter Secondary.....	A-8670	Air Filter Secondary.....	A-5576	Fuel Filter.....	FC-5103
Hydraulic Oil Filter.....	HC-5504	Air Filter Primary.....	A-5577	Hydraulic Oil Filter.....	H-5517
Oil Filter Full Flow.....	C-5102	Hydraulic Oil Filter Transmission...	HC-5501	Hydraulic Oil Filter Transmission...	HC-5501
PS-360C (COMPACTORS) CAT S/N: PJF1-UP		Hydraulic Oil Filter.....	H-5517	Oil Filter Full Flow.....	C-5101
Air Filter Primary.....	A-5673	Oil Filter Full Flow.....	C-5101		
Air Filter Set.....	A-5675-S			RH62 (HANDLER TELESCOPIC) PERKINS	
Air Filter Secondary.....	A-8670	R40 THRU RC60 (FORKLIFTS) PERKINS 4.236 DIESEL (S/N: 21A-UP)		Hydraulic Oil Filter.....	HC-5506
Hydraulic Oil Filter.....	HC-5504	Air Filter Set.....	A-5578-S	Hydraulic Oil Filter.....	HC-5503
Oil Filter Full Flow.....	C-5102	Air Filter Set.....	A-5579-S	Oil Filter Full Flow.....	C-5101
PS-360C (COMPACTORS) w/3054C Eng.		Air Filter Secondary.....	A-5576	Oil Filter Full Flow.....	C-5102
Fuel/Water Separator.....	SFC-43040	Air Filter Primary.....	A-5577		
PS-300 (COMPACTORS) DEUTZ F6L912		Fuel Filter.....	FC-5103	RH82 (HANDLER TELESCOPIC) PERKINS	
		Hydraulic Oil Filter.....	H-5517	Hydraulic Oil Filter.....	HC-5503
		Hydraulic Oil Filter Transmission...	HC-5501	Hydraulic Oil Filter.....	HC-5506
		Oil Filter Full Flow.....	C-5101	Oil Filter Full Flow.....	C-5102
				Oil Filter Full Flow.....	C-5101
		R40 THRU RC60 (FORKLIFTS) PERKINS 4.236 DIESEL (S/N: 31A-UP)			
		Air Filter Set.....	A-5579-S		

MODEL/APPLICATION	SAKURA NO	MODEL/APPLICATION	SAKURA NO	MODEL/APPLICATION	SAKURA NO
CATERPILLAR		CATERPILLAR		CATERPILLAR	
RM-300 (ROTARY MIXERS) CAT S/N: BW1-UP Air Filter Secondary..... A-5534 Air Filter Primary..... A-5535 Air Filter Set..... A-5573-S Cabin Air Filter..... CA-55060 Fuel Filter..... FC-5517 Hydraulic Oil Filter..... HC-55220 Hydraulic Oil Filter..... H-5517 Hydraulic Oil Filter..... HC-5507		Hydraulic Oil Filter..... HC-5507 Hydraulic Oil Filter..... H-5506 Hydraulic Oil Filter..... HC-55300 Hydraulic Oil Filter..... HC-55220 Hydraulic Oil Filter..... HC-5516 Hydraulic Oil Filter..... H-5517 Oil Filter Full Flow..... C-5516 RM-350 (ROTARY MIXERS) CAT S/N: 5FK104-UP Air Filter Secondary..... A-5556 Air Filter Set..... A-5555-S Air Filter Primary..... A-5555 Fuel Filter..... FC-5509 Hydraulic Oil Filter..... H-5517 Hydraulic Oil Filter..... HC-5507 Hydraulic Oil Filter..... HC-5516 Hydraulic Oil Filter..... HC-55220 Hydraulic Oil Filter..... HC-55300 Oil Filter Full Flow..... C-5516 RM-350 (ROTARY MIXERS) CAT S/N: 5FK1-40-UP Air Filter Primary..... A-5521 Air Filter Set..... A-5521-S Air Filter Secondary..... A-5529 Fuel Filter..... FC-5509 Hydraulic Oil Filter..... H-5517 Hydraulic Oil Filter..... HC-5507 Hydraulic Oil Filter..... HC-55220 Oil Filter Full Flow..... C-5516 RM-350 (ROTARY MIXERS) CAT S/N: 5FK41-103-UP Air Filter Set..... A-5555-S Air Filter Secondary..... A-5556 Air Filter Primary..... A-5555 Fuel Filter..... FC-5509 Hydraulic Oil Filter..... H-5517 Hydraulic Oil Filter..... HC-5507 Hydraulic Oil Filter..... HC-55220 Oil Filter Full Flow..... C-5516 RM367 (COMPACTORS) CAT 3406 (S/N: 87X00752-87X01455) Air Filter Secondary..... A-5502 Fuel Filter..... F-5505 RM-500 (ROTARY MIXERS) CAT S/N: ASW1-109-UP , 2006-UP Air Filter Set..... A-5565-S Air Filter Primary..... A-5564 Air Filter Secondary..... A-5563 Fuel Filter..... FC-5517 RM-500 (ROTARY MIXERS) CAT S/N: ASW110-UP , 2006-UP Air Filter Secondary..... A-5563 Air Filter Primary..... A-5564 Air Filter Set..... A-5565-S Cabin Air Filter..... CA-55060 Fuel Filter..... FC-5517 Hydraulic Oil Filter..... H-5517 Hydraulic Oil Filter..... HC-5507 Hydraulic Oil Filter..... HC-5506		Hydraulic Oil Filter..... HC-5503 Hydraulic Oil Filter..... HC-55220 Hydraulic Oil Filter..... HC-5512 RM-500 (ROTARY MIXERS) CAT S/N: LHX1-UP , 2006-UP Air Filter Secondary..... A-5563 Air Filter Set..... A-5565-S Air Filter Primary..... A-5564 Cabin Air Filter..... CA-55060 Fuel Filter..... FC-5517 Hydraulic Oil Filter..... HC-5512 Hydraulic Oil Filter..... HC-55220 Hydraulic Oil Filter..... HC-5503 Hydraulic Oil Filter..... HC-5506 Hydraulic Oil Filter..... HC-5507 Hydraulic Oil Filter..... H-5517 RR-250 (ROAD RECLAIMER) S/N: 6ED1-UP Air Filter Secondary..... A-5529 Air Filter Set..... AS-5656-S Air Filter Primary..... AS-7805 Fuel Filter..... FC-5519 Fuel Filter..... FC-5509 Oil Filter Full Flow..... C-5516 RR-250B (ROAD RECLAIMER) Air Filter Secondary..... A-5529 Coolant Filter..... WC-6901 Fuel Filter..... FC-5509 Hydraulic Oil Filter..... H-5517 RT100 (HANDLER TELESCOPIC) S/N: 1GJ1-UP Air Filter Primary..... A-5511 Air Filter Set..... A-5511-S Fuel Filter..... FC-5501 Oil Filter Full Flow..... C-5505 RT40 THRU RTC60 (FORKLIFTS) PERKINS 4.236 DIESEL (S/N: 4XG-UP) Air Filter Secondary..... A-5576 Air Filter Primary..... A-5577 Air Filter Set..... A-5578-S Air Filter Set..... A-5579-S Fuel Filter..... FC-5103 Hydraulic Oil Filter..... H-5517 Hydraulic Oil Filter Transmission... HC-5501 Oil Filter Full Flow..... C-5101 RT50 (HANDLER TELESCOPIC) S/N: 4XG1-UP Air Filter Set..... A-5579-S Air Filter Set..... A-5578-S Air Filter Primary..... A-5577 Air Filter Secondary..... A-5576 Fuel Filter..... FC-5103 Hydraulic Oil Filter Transmission... HC-5501 Oil Filter Full Flow..... C-5101 RT50 (SA) (HANDLER TELESCOPIC) Air Filter Primary..... A-5507	
RM-300 (ROTARY MIXERS) CAT S/N: RSX1-UP Air Filter Secondary..... A-5534 Air Filter Set..... A-5573-S Air Filter Primary..... A-5535 Cabin Air Filter..... CA-55060 Fuel Filter..... FC-5517 Hydraulic Oil Filter..... HC-5507 Hydraulic Oil Filter..... H-5517 Hydraulic Oil Filter..... HC-55220					
RM-300 (ROTARY MIXERS) w/C11 Eng. Air Filter Primary..... A-5535M Air Filter Set..... A-5573M-S					
RM-350B (ROTARY MIXERS) CAT 3406C Air Filter Primary..... A-5555 Air Filter Set..... A-5555-S Air Filter Secondary..... A-5556 Fuel Filter..... F-5505 Fuel Filter..... FC-5509 Hydraulic Oil Filter..... H-5517 Hydraulic Oil Filter..... HC-5516 Oil Filter Full Flow..... C-5516					
RM-350 (ROTARY MIXERS) CAT S/N: 11N7919-UP Air Filter Secondary..... A-5529 Air Filter Set..... A-5521-S Air Filter Primary..... A-5521 Air Filter Secondary..... A-5556 Air Filter Set..... A-5555-S Air Filter Primary..... A-5555 Fuel Filter..... FC-5509 Hydraulic Oil Filter..... H-5517 Hydraulic Oil Filter..... HC-5516 Hydraulic Oil Filter..... HC-55220 Hydraulic Oil Filter..... HC-55300 Hydraulic Oil Filter..... HC-5507 Oil Filter Full Flow..... C-5516					
RM-350 (ROTARY MIXERS) CAT S/N: 41Z257-UP Air Filter Secondary..... A-5529 Air Filter Primary..... A-5555 Air Filter Set..... A-5555-S Air Filter Secondary..... A-5556 Air Filter Primary..... A-5521 Air Filter Set..... A-5521-S Fuel Filter..... FC-5509					

MODEL/APPLICATION	SAKURA NO
CATERPILLAR	
RT50 (SA) <i>(HANDLER TELESCOPIC)</i>	
Air Filter Set.....	A-5507-S
Air Filter Secondary.....	A-5508
Air Filter Set.....	A-55071-S
Fuel Filter.....	FC-5103
Hydraulic Oil Filter Transmission...	HC-5501
Oil Filter Full Flow.....	C-5101
RT505A <i>(HANDLER TELESCOPIC)</i>	
Air Filter Secondary.....	A-5576
Air Filter Primary.....	A-5577
Air Filter Set.....	A-5578-S
Air Filter Set.....	A-5579-S
Fuel Filter.....	FC-5103
Hydraulic Oil Filter Transmission...	HC-5501
Oil Filter Full Flow.....	C-5101
RT60 <i>(FORKLIFTS)</i> PERKINS 4.236 DIESEL (S/N: 5DG-UP)	
Air Filter Set.....	A-5579-S
Air Filter Set.....	A-5578-S
Air Filter Primary.....	A-5577
Air Filter Secondary.....	A-5576
Fuel Filter.....	FC-5103
Hydraulic Oil Filter.....	H-5517
Hydraulic Oil Filter Transmission...	HC-5501
Oil Filter Full Flow.....	C-5101
RT80 <i>(HANDLER TELESCOPIC)</i> S/N: 2YC1-UP	
Air Filter Secondary.....	A-5525
Air Filter Primary.....	A-5542
Air Filter Set.....	A-5542-S
Fuel Filter.....	FC-5503
Hydraulic Oil Filter.....	H-5504
Oil Filter Full Flow.....	C-5519
RT80 <i>(HANDLER TELESCOPIC)</i> S/N: 3JN1-UP	
Air Filter Primary.....	A-76231
Air Filter Primary.....	A-5541M
Air Filter Set.....	A-5541M-S
Air Filter Primary.....	A-5541
Air Filter Secondary.....	A-5540
Hydraulic Oil Filter.....	HC-5503
Oil Filter Full Flow.....	C-5102
Oil Filter Full Flow.....	C-5101
RT80 <i>(HANDLER TELESCOPIC)</i> S/N: 3NN1-UP	
Air Filter Primary.....	A-76231
Air Filter Secondary.....	A-5540
Air Filter Primary.....	A-5541
Air Filter Set.....	A-5541M-S
Air Filter Primary.....	A-5541M
Hydraulic Oil Filter.....	HC-5503
Oil Filter Full Flow.....	C-5102
Oil Filter Full Flow.....	C-5101
RT80 <i>(HANDLER TELESCOPIC)</i> S/N: 3RN1-UP	
Air Filter Primary.....	A-76231

MODEL/APPLICATION	SAKURA NO
CATERPILLAR	
Air Filter Primary.....	A-5541M
Air Filter Set.....	A-5541M-S
Air Filter Primary.....	A-5541
Air Filter Secondary.....	A-5540
Hydraulic Oil Filter.....	HC-5503
Oil Filter Full Flow.....	C-5102
Oil Filter Full Flow.....	C-5101
RT80 <i>(HANDLER TELESCOPIC)</i> S/N: 5MM1-UP	
Air Filter Primary.....	A-76231
Air Filter Secondary.....	A-5540
Air Filter Primary.....	A-5541
Air Filter Set.....	A-5541M-S
Air Filter Primary.....	A-5541M
Hydraulic Oil Filter.....	HC-5503
Oil Filter Full Flow.....	C-5102
Oil Filter Full Flow.....	C-5101
RTC60 <i>(FORKLIFTS)</i>	
Hydraulic Oil Filter Transmission...	HC-5501
Oil Filter Full Flow.....	C-5101
SF175 <i>(SLIPFORM PAVER)</i> S/N: 52C1-UP	
Air Filter Primary.....	A-2210
Fuel Filter Secondary.....	FC-5507
SF175 <i>(SLIPFORM PAVER)</i> S/N: 52C1-UP	
Air Filter.....	A-5553
Fuel Filter Secondary.....	FC-5507
Oil Filter Full Flow.....	C-5519
SF250 <i>(SLIPFORM PAVER)</i> S/N: 6XC1-UP	
Air Filter.....	A-5553
Fuel Filter Secondary.....	FC-5507
Hydraulic Oil Filter.....	H-51170
Oil Filter Full Flow.....	C-5519
SF350 <i>(SLIPFORM PAVER)</i> S/N: 5RD1-UP	
Fuel Filter Secondary.....	FC-5507
Oil Filter Full Flow.....	C-5510
SF450 <i>(SLIPFORM PAVER)</i> S/N: 7GC1-UP	
Fuel Filter Secondary.....	FC-5507
Oil Filter Full Flow.....	C-5510
SF550 <i>(SLIPFORM PAVER)</i> S/N: 5PD1-UP	
Air Filter Secondary.....	A-6902
Fuel Filter.....	FC-5519
Fuel Filter.....	FC-5509
Hydraulic Oil Filter.....	H-51170
Oil Filter Full Flow.....	C-5516
SM-350 <i>(ROAD RECLAIMER)</i> S/N: 1RM1-UP	
Air Filter Secondary.....	A-5529
Fuel Filter.....	FC-5509
Oil Filter Full Flow.....	C-5516

MODEL/APPLICATION	SAKURA NO
CATERPILLAR	
SS-250 <i>(STABILIZERS)</i> S/N: 6DD1-UP	
Air Filter Secondary.....	A-5529
Fuel Filter Secondary.....	FC-5507
Oil Filter Full Flow.....	C-5516
SS-250B <i>(STABILIZERS)</i> CAT S/N: 11N13299-UP	
Air Filter Secondary.....	A-5556
Air Filter Primary.....	A-5555
Air Filter Set.....	A-5555-S
Fuel Filter.....	FC-5509
Hydraulic Oil Filter.....	H-5517
Hydraulic Oil Filter.....	HC-55220
Hydraulic Oil Filter.....	HC-5507
Oil Filter Full Flow.....	C-5516
SS-250B <i>(STABILIZERS)</i> CAT S/N: 41Z1-UP	
Air Filter Set.....	A-5555-S
Air Filter Primary.....	A-5555
Air Filter Secondary.....	A-5556
Fuel Filter.....	FC-5509
Fuel Filter.....	FC-5519
Hydraulic Oil Filter.....	HC-5507
Hydraulic Oil Filter.....	HC-55220
Hydraulic Oil Filter.....	H-5517
SS-250B <i>(STABILIZERS)</i> CAT S/N: 5GR1-UP	
Air Filter Secondary.....	A-5556
Air Filter Primary.....	A-5555
Air Filter Set.....	A-5555-S
Fuel Filter.....	FC-5519
Fuel Filter.....	FC-5509
Hydraulic Oil Filter.....	H-5517
Hydraulic Oil Filter.....	HC-55220
Hydraulic Oil Filter.....	HC-5507
Oil Filter Full Flow.....	C-5516
T100D-T150D <i>(FORKLIFTS)</i> PERKINS 4.236 GAS (S/N: 5MB-UP)	
Air Filter Primary.....	A-5577
Air Filter Set.....	A-5578-S
Air Filter Set.....	A-5579-S
Air Filter Secondary.....	A-5576
Hydraulic Oil Filter Transmission...	HC-5501
Oil Filter Full Flow.....	C-5101
T100D-T150D <i>(FORKLIFTS)</i> PERKINS 4.2482 DIESEL (S/N: 5NB-UP)	
Air Filter Set.....	A-5579-S
Air Filter Set.....	A-5578-S
Air Filter Primary.....	A-5577
Air Filter Secondary.....	A-5576
Fuel Filter.....	FC-5103
Hydraulic Oil Filter Transmission...	HC-5501
Oil Filter Full Flow.....	C-5101
T25D-TC40D <i>(FORKLIFTS)</i> PEUGEOT XN1P (S/N: 5GB-UP)	
Hydraulic Oil Filter Transmission...	HC-5501
Oil Filter Full Flow.....	C-1005

MODEL/APPLICATION	SAKURA NO	MODEL/APPLICATION	SAKURA NO	MODEL/APPLICATION	SAKURA NO
CATERPILLAR		CATERPILLAR		CATERPILLAR	
T25D-TC40D (<i>FORKLIFTS</i>) PEUGEOT XN1P GAS (S/N: 5GB-UP) Hydraulic Oil Filter Transmission... HC-5501 Oil Filter Full Flow..... C-1005		Air Filter Set..... A-5578-S Air Filter Set..... A-5579-S Oil Filter Full Flow..... C-5504		T30C-TC60C (<i>FORKLIFTS</i>) CAT 1404 (S/N: 93W-UP) Air Filter Secondary..... A-5576 Air Filter Primary..... A-5577 Air Filter Set..... A-5578-S Air Filter Set..... A-5579-S Hydraulic Oil Filter..... H-79411 Oil Filter Full Flow..... C-5504	
T25-TC30 (<i>FORKLIFTS</i>) CONTINEL F-163 (S/N: 11X-UP) Air Filter..... A-5424 Hydraulic Oil Filter..... H-79411		T30B-T60B (<i>FORKLIFTS</i>) CONTINEL F-163 GAS (S/N: 40N-UP) Air Filter..... A-5424 Hydraulic Oil Filter..... H-79411		T30C-TC60C (<i>FORKLIFTS</i>) PERKINS 4.2032 (S/N: 66S-UP) Air Filter Set..... A-5579-S Air Filter Secondary..... A-5576 Air Filter Set..... A-5578-S Air Filter Primary..... A-5577 Fuel Filter..... FC-5103 Hydraulic Oil Filter Transmission... HC-5501 Oil Filter Full Flow..... C-5101	
T25-TC30 (<i>FORKLIFTS</i>) CONTINEL F-163 (S/N: 12X-UP) Air Filter..... A-5424		T30B-T60B (<i>FORKLIFTS</i>) CONTINEL F-163 GAS (S/N: 41N-UP) Air Filter..... A-5424		T30-T60 (<i>FORKLIFTS</i>) CONTINEL F-163 (S/N: 07N-UP) Hydraulic Oil Filter..... H-79411	
T25-TC30 (<i>FORKLIFTS</i>) CONTINEL F-163 (S/N: 22Y-UP) Air Filter..... A-5424 Hydraulic Oil Filter Transmission... HC-5501		T30B-T60B (<i>FORKLIFTS</i>) CONTINEL F-163 GAS (S/N: 42N-UP) Air Filter..... A-5424 Hydraulic Oil Filter..... H-79411		T30-T60 (<i>FORKLIFTS</i>) PERKINS 3.152 DIESEL (S/N: 48G-UP) Fuel Filter..... FC-5103 Oil Filter Full Flow..... O-5001	
T25-TC30 (<i>FORKLIFTS</i>) CONTINEL F-163 (S/N: 61V-UP) Air Filter..... A-5424 Oil Filter Full Flow..... C-5504		T30B-T60B (<i>FORKLIFTS</i>) CONTINEL F-163 GAS (S/N: 61R-UP) Air Filter..... A-5424		T30-T60 (<i>FORKLIFTS</i>) PERKINS 3.152 DIESEL (S/N: 95H-UP) Fuel Filter..... FC-5103 Hydraulic Oil Filter..... H-79411 Oil Filter Full Flow..... O-5001	
T25-TC30 (<i>FORKLIFTS</i>) CONTINEL F-163 (S/N: 71V-UP) Air Filter..... A-5424 Hydraulic Oil Filter..... H-79411		T30B-T60B (<i>FORKLIFTS</i>) CONTINEL F-163 GAS (S/N: 62R-UP) Air Filter..... A-5424 Hydraulic Oil Filter..... H-79411		T40B (<i>FORKLIFTS</i>) CAT 1404 Air Filter Set..... A-5579-S Air Filter Set..... A-5578-S Air Filter Primary..... A-5577 Air Filter Secondary..... A-5576 Oil Filter Full Flow..... C-5504	
T25-TC30 (<i>FORKLIFTS</i>) CONTINEL F-163 GAS (S/N: 12X-UP) Air Filter..... A-5424		T30B-T60B (<i>FORKLIFTS</i>) CONTINEL F-163 GAS (S/N: 63P-UP) Air Filter..... A-5424		T40B (<i>FORKLIFTS</i>) PERKINS 3.152 Fuel Filter..... FC-5103	
T25-TC30 (<i>FORKLIFTS</i>) CONTINEL F-163 GAS (S/N: 61V-UP) Air Filter..... A-5424		T30B-T60B (<i>FORKLIFTS</i>) CONTINEL F-163 GAS (S/N: 64P-UP) Air Filter..... A-5424 Hydraulic Oil Filter..... H-79411		T40C LIFT (<i>FORKLIFTS</i>) Air Filter Secondary..... A-5576 Air Filter Primary..... A-5577 Air Filter Set..... A-5578-S Air Filter Set..... A-5579-S Fuel Filter..... F-1901 Oil Filter Full Flow..... C-5103	
T30B-T60B (<i>FORKLIFTS</i>) CAT 1404 (S/N: 13Y-UP) Air Filter Set..... A-5579-S Air Filter Set..... A-5578-S Air Filter Primary..... A-5577 Air Filter Secondary..... A-5576 Hydraulic Oil Filter..... H-79411 Oil Filter Full Flow..... C-5504		T30B-T60B (<i>FORKLIFTS</i>) CONTINEL F-163 GAS (S/N: 92P-UP) Air Filter..... A-5424		T40D-TC60D (<i>FORKLIFTS</i>) PEUGEOT XD3P DIESEL (S/N: 2YB-UP) Fuel Filter..... FC-5101 Hydraulic Oil Filter Transmission... HC-5501 Oil Filter Full Flow..... C-1005	
T30B-T60B (<i>FORKLIFTS</i>) CAT 1404 (S/N: 15Y-UP) Air Filter Secondary..... A-5576 Air Filter Primary..... A-5577 Air Filter Set..... A-5578-S Air Filter Set..... A-5579-S Oil Filter Full Flow..... C-5504		T30B-T60B (<i>FORKLIFTS</i>) PERKINS 3.152 DIESEL (S/N: 47S-UP) Fuel Filter..... FC-5103 Oil Filter Full Flow..... O-5001			
T30B-T60B (<i>FORKLIFTS</i>) CAT 1404 (S/N: 16Y-UP) Air Filter Set..... A-5579-S Air Filter Set..... A-5578-S Air Filter Primary..... A-5577 Air Filter Secondary..... A-5576 Hydraulic Oil Filter..... H-79411 Oil Filter Full Flow..... C-5504		T30B-T60B (<i>FORKLIFTS</i>) PERKINS 3.152 DIESEL (S/N: 48S-UP) Fuel Filter..... FC-5103 Hydraulic Oil Filter..... H-79411 Oil Filter Full Flow..... O-5001			
T30B-T60B (<i>FORKLIFTS</i>) CAT 1404 (S/N: 17Y-UP) Air Filter Secondary..... A-5576 Air Filter Primary..... A-5577		T30C-TC60C (<i>FORKLIFTS</i>) CAT 1404 (S/N: 38Y-UP) Air Filter Secondary..... A-5576 Air Filter Primary..... A-5577 Air Filter Set..... A-5578-S Air Filter Set..... A-5579-S Hydraulic Oil Filter Transmission... HC-5501 Oil Filter Full Flow..... C-5504			

MODEL/APPLICATION	SAKURA NO	MODEL/APPLICATION	SAKURA NO	MODEL/APPLICATION	SAKURA NO
CATERPILLAR		CATERPILLAR		CATERPILLAR	
T40D-TC60D (<i>FORKLIFTS</i>) PEUGEOT XN1P (S/N: 8EB-UP)		Hydraulic Oil Filter Transmission... HC-5501 Oil Filter Full Flow..... C-5504		Hydraulic Oil Filter Transmission... HC-5501 Oil Filter Full Flow..... C-5101	
Hydraulic Oil Filter Transmission... HC-5501 Oil Filter Full Flow..... C-1005		T60C-T120C (<i>FORKLIFTS</i>) CONTINEL F-227 (S/N: 18N-UP)	H-79411	T60D-TC120D (<i>FORKLIFTS</i>) PERKINS 4.236 (S/N: 5RB-UP)	
T40D-TC60D SA (<i>FORKLIFTS</i>) CAT 1404		Hydraulic Oil Filter..... H-79411		Air Filter Set..... A-5579-S Air Filter Set..... A-5578-S Air Filter Primary..... A-5577 Air Filter Secondary..... A-5576 Hydraulic Oil Filter Transmission... HC-5501 Oil Filter Full Flow..... C-5504	
Air Filter Set..... A-5579-S Air Filter Set..... A-5578-S Air Filter Primary..... A-5577 Air Filter Secondary..... A-5576 Hydraulic Oil Filter Transmission... HC-5501 Oil Filter Full Flow..... C-5504		T60C-T120C (<i>FORKLIFTS</i>) CONTINEL F-227 (S/N: 33L-UP)	H-79411	Air Filter Set..... A-5579-S Air Filter Set..... A-5578-S Air Filter Primary..... A-5577 Air Filter Secondary..... A-5576 Hydraulic Oil Filter..... H-79411 Oil Filter Full Flow..... C-5101	
T40D-TC60D SA (<i>FORKLIFTS</i>) CAT 1404 (S/N: 2LC-UP)		T60C-T120C (<i>FORKLIFTS</i>) CONTINEL F-227 (S/N: 35R-UP)	H-79411	T60D-TC120D (<i>FORKLIFTS</i>) PERKINS 4.236 GAS (S/N: 5KB-UP)	
Air Filter Secondary..... A-5576 Air Filter Primary..... A-5577 Air Filter Set..... A-5578-S Air Filter Set..... A-5579-S Hydraulic Oil Filter Transmission... HC-5501 Oil Filter Full Flow..... C-5504		Hydraulic Oil Filter..... H-79411		Air Filter Secondary..... A-5576 Air Filter Primary..... A-5577 Air Filter Set..... A-5578-S Air Filter Set..... A-5579-S Hydraulic Oil Filter Transmission... HC-5501 Oil Filter Full Flow..... C-5101	
T40D-TC60D SA (<i>FORKLIFTS</i>) CAT 1404 (S/N: 9PB-UP)		T60C-T120C (<i>FORKLIFTS</i>) CONTINEL F-227 (S/N: 53R-UP)	H-79411	T60D-TC120D (<i>FORKLIFTS</i>) PERKINS 4.236 GAS (S/N: 5RB-UP)	
Air Filter Set..... A-5579-S Air Filter Set..... A-5578-S Air Filter Primary..... A-5577 Air Filter Secondary..... A-5576 Hydraulic Oil Filter Transmission... HC-5501 Oil Filter Full Flow..... C-5504		Hydraulic Oil Filter..... H-79411		Air Filter Set..... A-5579-S Air Filter Set..... A-5578-S Air Filter Primary..... A-5577 Air Filter Secondary..... A-5576 Hydraulic Oil Filter..... H-79411 Oil Filter Full Flow..... C-5101	
T40D-TC60D SA (<i>FORKLIFTS</i>) CAT 1404 GAS (S/N: 2LC-UP)		T60C-T120C (<i>FORKLIFTS</i>) CONTINEL F-227 (S/N: 56Y-UP)	H-79411	T60D-TC120D (<i>FORKLIFTS</i>) PERKINS 4.2482 DIESEL (S/N: 5LB-UP)	
Air Filter Secondary..... A-5576 Air Filter Primary..... A-5577 Air Filter Set..... A-5578-S Air Filter Set..... A-5579-S Hydraulic Oil Filter Transmission... HC-5501 Oil Filter Full Flow..... C-5504		Air Filter Set..... A-5579-S Air Filter Secondary..... A-5576 Air Filter Primary..... A-5577 Air Filter Set..... A-5578-S		Air Filter Secondary..... A-5576 Air Filter Primary..... A-5577 Air Filter Set..... A-5578-S Air Filter Set..... A-5579-S Fuel Filter..... FC-5103 Hydraulic Oil Filter Transmission... HC-5501 Oil Filter Full Flow..... C-5101	
T40D-TC60D SA (<i>FORKLIFTS</i>) CAT 1404 GAS (S/N: 9PB-UP)		T60C-T120C (<i>FORKLIFTS</i>) CONTINEL F-227 GAS (S/N: 18N-UP)	H-79411	T60D-TC120D (<i>FORKLIFTS</i>) PERKINS 4.2482 DIESEL (S/N: 5PB-UP)	
Air Filter Secondary..... A-5576 Air Filter Primary..... A-5577 Air Filter Set..... A-5578-S Air Filter Set..... A-5579-S Hydraulic Oil Filter Transmission... HC-5501 Oil Filter Full Flow..... C-5504		Hydraulic Oil Filter..... H-79411		Air Filter Set..... A-5579-S Air Filter Set..... A-5578-S Air Filter Primary..... A-5577 Air Filter Secondary..... A-5576 Fuel Filter..... FC-5103 Hydraulic Oil Filter..... H-79411 Oil Filter Full Flow..... C-5101	
T40D-TC60D SA (<i>FORKLIFTS</i>) CAT 1404 GAS (S/N: 9PB-UP)		T60C-T120C (<i>FORKLIFTS</i>) CONTINEL F-227 GAS (S/N: 33L-UP)	H-79411	TH103 (<i>HANDLER TELESCOPIC</i>) CAT 3054 (S/N: 3PN2500-UP)	
Air Filter Secondary..... A-5576 Air Filter Primary..... A-5577 Air Filter Set..... A-5578-S Air Filter Set..... A-5579-S Hydraulic Oil Filter Transmission... HC-5501 Oil Filter Full Flow..... C-5504		Hydraulic Oil Filter..... H-79411		Air Filter Secondary..... A-5540 Hydraulic Oil Filter..... HC-5512 Oil Filter Full Flow..... C-5102	
T40D-TC60D SA (<i>FORKLIFTS</i>) CAT 1404 GAS (S/N: 9PB-UP)		T60C-T120C (<i>FORKLIFTS</i>) CONTINEL F-227 GAS (S/N: 35R-UP)	H-79411	TH103 (<i>HANDLER TELESCOPIC</i>) CAT 7BJ1-UP	
Air Filter Secondary..... A-5576 Air Filter Primary..... A-5577 Air Filter Set..... A-5578-S Air Filter Set..... A-5579-S Hydraulic Oil Filter Transmission... HC-5501 Oil Filter Full Flow..... C-5504		Hydraulic Oil Filter..... H-79411		Air Filter Set..... A-56731-S Air Filter Secondary..... A-56741 Air Filter Primary..... A-56731	
T50E (<i>FORKLIFTS</i>)		T60C-T120C (<i>FORKLIFTS</i>) CONTINEL F-227 GAS (S/N: 53R-UP)	H-79411	TH103 (<i>HANDLER TELESCOPIC</i>) S/N: 3PN1-UP	
Air Filter Set..... A-5537-S Air Filter Primary..... A-5537		Hydraulic Oil Filter..... H-79411		Air Filter Set..... A-5541M-S	
T60 (<i>FORKLIFTS</i>) PERKINS 3.152		T60C-T120C (<i>FORKLIFTS</i>) CONTINEL F-227 GAS (S/N: 56Y-UP)	H-79411		
Fuel Filter..... FC-5103		Air Filter Set..... A-5579-S Air Filter Secondary..... A-5576 Air Filter Primary..... A-5577 Air Filter Set..... A-5578-S			
T60C (<i>FORKLIFTS</i>) CAT 1404		T60D-TC120D (<i>FORKLIFTS</i>) PERKINS 4.236 (S/N: 5KB-UP)	H-79411		
Air Filter Secondary..... A-5576 Air Filter Primary..... A-5577 Air Filter Set..... A-5578-S Air Filter Set..... A-5579-S		Air Filter Secondary..... A-5576 Air Filter Primary..... A-5577 Air Filter Set..... A-5578-S Air Filter Set..... A-5579-S			

MODEL/APPLICATION	SAKURA NO	MODEL/APPLICATION	SAKURA NO	MODEL/APPLICATION	SAKURA NO
CATERPILLAR		CATERPILLAR		CATERPILLAR	
TH103 (HANDLER TELESCOPIC) S/N: 3PN1-UP		Air Filter Primary.....	A-5673	Air Filter Secondary.....	A-56741
Air Filter Primary.....	A-5541M	Hydraulic Oil Filter.....	HC-5504	Air Filter Set.....	A-56731-S
Air Filter Primary.....	A-5541	Oil Filter Full Flow.....	C-5102	Air Filter Primary.....	A-56731
Air Filter Secondary.....	A-5540				
Air Filter Primary.....	A-76231	TH340B (HANDLER TELESCOPIC) w/3054E Eng.		TH360B (HANDLER TELESCOPIC) S/N: SLE1-01250-UP	
Oil Filter Full Flow.....	C-5102	Fuel/Water Separator.....	SFC-43040	Air Filter Secondary.....	A-8670
				Air Filter Primary.....	A-5673
TH210 (HANDLER TELESCOPIC) CAT 3054 (S/N: CEC1-UP)		TH350B (HANDLER TELESCOPIC) S/N: SLD1-00531-UP		Air Filter Set.....	A-5675-S
Air Filter Secondary.....	A-5540	Air Filter Secondary.....	A-8670	Hydraulic Oil Filter.....	HC-5504
Oil Filter Full Flow.....	C-5101	Air Filter Set.....	A-5675-S	Oil Filter Full Flow.....	C-5102
		Air Filter Primary.....	A-5673		
TH210 (HANDLER TELESCOPIC) w/3054C Eng.		Hydraulic Oil Filter.....	HC-5504	TH360B (HANDLER TELESCOPIC) w/3054E Eng.	
Fuel/Water Separator.....	SFC-43040	Oil Filter Full Flow.....	C-5102	Fuel/Water Separator.....	SFC-43040
TH215 (HANDLER TELESCOPIC) CAT 3054 (S/N: CEG1-09999-UP)		TH350B (HANDLER TELESCOPIC) w/3054E Eng.		TH330B (HANDLER TELESCOPIC) CAT 3054E , 2012	
Air Filter Secondary.....	A-5540	Fuel/Water Separator.....	SFC-43040	Air Filter Secondary.....	A-56741
Oil Filter Full Flow.....	C-5101			Air Filter Set.....	A-56731-S
		TH355B (HANDLER TELESCOPIC) CATERPILLAR		Air Filter Primary.....	A-56731
TH215 (HANDLER TELESCOPIC) w/3054C Eng.		Air Filter Primary.....	A-5673	TH330B (HANDLER TELESCOPIC) CAT 3054 (S/N: SLB1-UP) , 2004-UP	
Fuel/Water Separator.....	SFC-43040	Air Filter Set.....	A-5675-S	Air Filter Primary.....	A-5673
		Air Filter Secondary.....	A-8670	Air Filter Set.....	A-5675-S
TH220B (HANDLER TELESCOPIC) CAT (S/N: CRX1-106)		Hydraulic Oil Filter.....	HC-5504	Air Filter Secondary.....	A-8670
Oil Filter Full Flow.....	C-5102	Oil Filter Full Flow.....	C-5102	Hydraulic Oil Filter.....	HC-5504
				Oil Filter Full Flow.....	C-5102
TH220B (HANDLER TELESCOPIC) CAT 3054 (S/N: SLA1-UP)		TH355B (HANDLER TELESCOPIC) CAT S/N: CRX1-647-UP		TH330B (HANDLER TELESCOPIC) w/3054E Eng.	
Air Filter Primary.....	A-5673	Air Filter Set.....	A-5675-S	Fuel/Water Separator.....	SFC-43040
Air Filter Set.....	A-5675-S	Air Filter Primary.....	A-5673		
Air Filter Secondary.....	A-8670	Air Filter Secondary.....	A-8670	TH336 (HANDLER TELESCOPIC) CAT C4.4 , 2008-UP	
Hydraulic Oil Filter.....	HC-5504	Hydraulic Oil Filter.....	HC-5504	Oil Filter Full Flow.....	C-5102
Oil Filter Full Flow.....	C-5102	TH355B (HANDLER TELESCOPIC) CAT S/N: JRK1-UP		TH337 (HANDLER TELESCOPIC) CAT C4.4 , 2008-UP	
		Air Filter Secondary.....	A-8670	Oil Filter Full Flow.....	C-5102
TH220B (HANDLER TELESCOPIC) w/3054E Eng.		Air Filter Primary.....	A-5673	TH330B SLB1 (HANDLER TELESCOPIC) CAT 3054 , 2004	
Fuel/Water Separator.....	SFC-43040	Air Filter Set.....	A-5675-S	Air Filter Set.....	A-56731-S
		Hydraulic Oil Filter.....	HC-5504	Air Filter Secondary.....	A-56741
TH255 (HANDLER TELESCOPIC) CAT C4.4 , 2008-UP		Oil Filter Full Flow.....	C-5102	Air Filter Primary.....	A-56731
Oil Filter Full Flow.....	C-5102	TH355B (HANDLER TELESCOPIC) CAT CRX1-647			
		Air Filter Secondary.....	A-56741	TH460B (HANDLER TELESCOPIC) CAT 3054E , 2012	
TH220B SLA1 (HANDLER TELESCOPIC) CAT 3054		Air Filter Set.....	A-56731-S	Air Filter Secondary.....	A-56741
Air Filter Secondary.....	A-56741	Air Filter Primary.....	A-56731	Air Filter Primary.....	A-56731
Air Filter Set.....	A-56731-S	TH355B (HANDLER TELESCOPIC) CAT CRX4387-UP			
Air Filter Primary.....	A-56731	Air Filter Primary.....	A-56731	Air Filter Secondary.....	A-56741
		Air Filter Set.....	A-56731-S	Air Filter Set.....	A-56731-S
TH340B (HANDLER TELESCOPIC) CAT 3054E , 2012		Air Filter Secondary.....	A-56741	Air Filter Primary.....	A-56731
Air Filter Primary.....	A-56731				
Air Filter Set.....	A-56731-S	TH355B (HANDLER TELESCOPIC) w/3054E Eng.		TH460B (HANDLER TELESCOPIC) CAT C4.4 (S/N: SLF1-00791-UP)	
Air Filter Secondary.....	A-56741	Fuel/Water Separator.....	SFC-43040	Air Filter Set.....	A-5675-S
				Air Filter Secondary.....	A-8670
TH340B (HANDLER TELESCOPIC) CAT 3054CRX648-UP , 2011		TH360B (HANDLER TELESCOPIC) CAT 3054E , 2012		Air Filter Primary.....	A-5673
Air Filter Set.....	A-56731-S	Air Filter Secondary.....	A-56741	Hydraulic Oil Filter.....	HC-5504
Air Filter Secondary.....	A-56741	Air Filter Set.....	A-56731-S	Oil Filter Full Flow.....	C-5102
Air Filter Primary.....	A-56731	Air Filter Primary.....	A-56731		
		TH355B (HANDLER TELESCOPIC) w/3054E Eng.		TH460B (HANDLER TELESCOPIC) w/3054E Eng.	
TH340B (HANDLER TELESCOPIC) CAT 3054 (S/N: SLC1-UP) , 2004-UP		Fuel/Water Separator.....	SFC-43040		
Air Filter Set.....	A-5675-S				
Air Filter Secondary.....	A-8670	TH360B (HANDLER TELESCOPIC) CAT 7BJ1-UP , 2011			
		Air Filter Secondary.....	A-56741		
		Air Filter Set.....	A-56731-S		
		Air Filter Primary.....	A-56731		

Sakura Filter

ENGINE APPLICATION

MODEL/APPLICATION	SAKURA NO	MODEL/APPLICATION	SAKURA NO	MODEL/APPLICATION	SAKURA NO
CATERPILLAR		CATERPILLAR		CATERPILLAR	
TH460B (HANDLER TELESCOPIC) w/3054E Eng. Fuel/Water Separator.....	SFC-43040	TH580B (HANDLER TELESCOPIC) CAT S/N: CRX1-206-UP , 2004-UP Air Filter Primary.....	A-5673	Air Filter Secondary.....	A-56741
TH406 (HANDLER TELESCOPIC) CAT C4.4 , 2008-UP Oil Filter Full Flow.....	C-5102	Air Filter Set.....	A-5675-S	Air Filter Set.....	A-56731-S
TH407 (HANDLER TELESCOPIC) CAT C4.4 , 2008-UP Oil Filter Full Flow.....	C-5102	Air Filter Secondary.....	A-8670	Air Filter Primary.....	A-56731
TH560B (HANDLER TELESCOPIC) CAT 3054E , 2012 Air Filter Set.....	A-56731-S	Hydraulic Oil Filter.....	HC-5504	TH580B (HANDLER TELESCOPIC) w/3054E Eng. Fuel/Water Separator.....	SFC-43040
Air Filter Secondary.....	A-56741	Oil Filter Full Flow.....	C-5102	TH62 (HANDLER TELESCOPIC) CAT 7BJ1-UP , 2011 Air Filter Set.....	A-56731-S
Air Filter Primary.....	A-56731	TH580B (HANDLER TELESCOPIC) CAT S/N: CRX207-647-UP , 2004-UP Air Filter Secondary.....	A-8670	Air Filter Secondary.....	A-56741
TH560B (HANDLER TELESCOPIC) CAT 3056E (S/N: TRA1-UP) Air Filter Primary.....	A-5549	Air Filter Set.....	A-5675-S	Air Filter Primary.....	A-56731
Air Filter Primary.....	A-5549M	Air Filter Primary.....	A-5673	TH62 (HANDLER TELESCOPIC) S/N: 3LN1-UP Air Filter Primary.....	A-76231
Air Filter Secondary.....	A-5550	Hydraulic Oil Filter.....	HC-5504	Air Filter Set.....	A-5541M-S
Air Filter Set.....	A-5549M-S	Oil Filter Full Flow.....	C-5102	Air Filter Primary.....	A-5541
Hydraulic Oil Filter.....	HC-5801	TH580B (HANDLER TELESCOPIC) CAT S/N: SLG1-UP , 2004-UP Air Filter Primary.....	A-5673	Air Filter Primary.....	A-5541M
Oil Filter Full Flow.....	C-5101	Air Filter Set.....	A-5675-S	Air Filter Secondary.....	A-5540
TH560B (HANDLER TELESCOPIC) CAT CRX107-UP Air Filter Primary.....	A-56731	Air Filter Secondary.....	A-8670	Hydraulic Oil Filter.....	HC-5512
Air Filter Secondary.....	A-56741	Air Filter Primary.....	A-5673	Hydraulic Oil Filter.....	HC-5506
Air Filter Set.....	A-56731-S	Hydraulic Oil Filter.....	HC-5504	Oil Filter Full Flow.....	C-5102
TH560B (HANDLER TELESCOPIC) CAT CRX207-UP Air Filter Set.....	A-56731-S	Oil Filter Full Flow.....	C-5102	TH62 (HANDLER TELESCOPIC) S/N: 4TM1-UP Air Filter Set.....	A-5541M-S
Air Filter Secondary.....	A-56741	TH580B (HANDLER TELESCOPIC) CAT S/N: SLH1-UP , 2004-UP Air Filter Primary.....	A-5673	Air Filter Primary.....	A-76231
Air Filter Primary.....	A-56731	Air Filter Set.....	A-5675-S	Air Filter Secondary.....	A-5540
TH560B (HANDLER TELESCOPIC) S/N: SLG1-UP Air Filter Secondary.....	A-8670	Air Filter Primary.....	A-5673	Air Filter Primary.....	A-5541M
Air Filter Set.....	A-5675-S	Hydraulic Oil Filter.....	HC-5504	Air Filter Primary.....	A-5541
Air Filter Primary.....	A-5673	Oil Filter Full Flow.....	C-5102	Hydraulic Oil Filter.....	HC-5506
Hydraulic Oil Filter.....	HC-5504	TH580B (HANDLER TELESCOPIC) CAT CRX648-UP , 2004 Air Filter Set.....	A-56731-S	Hydraulic Oil Filter.....	HC-5512
Oil Filter Full Flow.....	C-5102	Air Filter Secondary.....	A-56741	Oil Filter Full Flow.....	C-5102
TH560B (HANDLER TELESCOPIC) w/3054E Eng. Fuel/Water Separator.....	SFC-43040	Air Filter Primary.....	A-56731	TH63 (HANDLER TELESCOPIC) CAT 7BJ1-UP Air Filter Primary.....	A-56731
TH580B (HANDLER TELESCOPIC) CAT S/N: CRX107-647-UP , 2004-UP Air Filter Secondary.....	A-8670	TH580B (HANDLER TELESCOPIC) CAT CRX107-UP Air Filter Set.....	A-56731-S	Air Filter Secondary.....	A-56741
Air Filter Primary.....	A-5673	Air Filter Secondary.....	A-56741	Air Filter Set.....	A-56731-S
Air Filter Set.....	A-5675-S	Air Filter Primary.....	A-56731	TH63 (HANDLER TELESCOPIC) S/N: 5WM-06021-99999-UP Air Filter Secondary.....	A-5540
Hydraulic Oil Filter.....	HC-5504	TH580B (HANDLER TELESCOPIC) CAT CRX1-106 Air Filter Primary.....	A-56731	Hydraulic Oil Filter.....	HC-5512
Oil Filter Full Flow.....	C-5102	Air Filter Secondary.....	A-56741	Oil Filter Full Flow.....	C-5102
TH560B (HANDLER TELESCOPIC) w/3054E Eng. Fuel/Water Separator.....	SFC-43040	Air Filter Set.....	A-56731-S	TH63 EN (HANDLER TELESCOPIC) S/N: 3KN1-UP Air Filter Secondary.....	A-5540
TH580B (HANDLER TELESCOPIC) CAT S/N: CRX107-647-UP , 2004-UP Air Filter Secondary.....	A-8670	Air Filter Secondary.....	A-56741	Oil Filter Full Flow.....	C-5102
Air Filter Primary.....	A-5673	TH580B (HANDLER TELESCOPIC) CAT CRX1-106 Air Filter Primary.....	A-56731	TH63 EN (HANDLER TELESCOPIC) S/N: 3NN1-UP Air Filter Secondary.....	A-5540
Air Filter Set.....	A-5675-S	Air Filter Secondary.....	A-56741	Oil Filter Full Flow.....	C-5102
Hydraulic Oil Filter.....	HC-5504	Air Filter Set.....	A-56731-S	TH82 (HANDLER TELESCOPIC) CAT 7BJ1-UP Air Filter Set.....	A-56731-S
Oil Filter Full Flow.....	C-5102	TH580B (HANDLER TELESCOPIC) CAT CRX1-206 Air Filter Set.....	A-56731-S	Air Filter Secondary.....	A-56741
TH580B (HANDLER TELESCOPIC) CAT S/N: CRX1-106-UP , 2004-UP Air Filter Secondary.....	A-8670	Air Filter Secondary.....	A-56741	Air Filter Primary.....	A-56731
Air Filter Set.....	A-5675-S	TH580B (HANDLER TELESCOPIC) CAT CRX207-UP Air Filter Primary.....	A-56731	TH82 (HANDLER TELESCOPIC) S/N: 3JN-01510-99999-UP Air Filter Secondary.....	A-5540
Air Filter Primary.....	A-5673	TH580B (HANDLER TELESCOPIC) CAT CRX207-UP Air Filter Primary.....	A-56731		
Hydraulic Oil Filter.....	HC-5504				
Oil Filter Full Flow.....	C-5102				

MODEL/APPLICATION	SAKURA NO
-------------------	-----------

CATERPILLAR

TH82
(HANDLER TELESCOPIC)
S/N: 3JN-01510-99999-UP
Hydraulic Oil Filter..... HC-5512
Oil Filter Full Flow..... C-5102

TH83
(HANDLER TELESCOPIC)
CAT 7B31-UP
Air Filter Primary..... A-56731
Air Filter Secondary..... A-56741
Air Filter Set..... A-56731-S

TH82 EN
(HANDLER TELESCOPIC)
S/N: 3KN1-UP
Air Filter Secondary..... A-5540
Hydraulic Oil Filter..... HC-5503
Hydraulic Oil Filter..... HC-5506
Oil Filter Full Flow..... C-5102

TH82 EN
(HANDLER TELESCOPIC)
S/N: 3NN1-UP
Air Filter Secondary..... A-5540
Hydraulic Oil Filter..... HC-5503
Hydraulic Oil Filter..... HC-5506
Oil Filter Full Flow..... C-5102

TH83 EN
(HANDLER TELESCOPIC)
S/N: 3KN1-UP
Air Filter Secondary..... A-5540
Oil Filter Full Flow..... C-5102

TH83 EN
(HANDLER TELESCOPIC)
S/N: 3NN1-UP
Air Filter Secondary..... A-5540
Oil Filter Full Flow..... C-5102

TK1051
(FELLER BUNCHERS)
CAT S/N: 3PD1-UP
Air Filter Primary..... A-8665M
Air Filter Secondary..... A-8580
Fuel Filter..... FC-5517
Fuel/Water Separator Secondary.. SFC-5504-10B
Fuel/Water Separator Secondary.. SFC-5504-10
Hydraulic Oil Filter..... HC-5801
Hydraulic Oil Filter..... HC-5505
Hydraulic Oil Filter..... HC-55170
Oil Filter Full Flow..... C-5516

TK1051
(FELLER BUNCHERS)
CAT S/N: 9HZ1-UP
Air Filter Secondary..... A-8580
Air Filter Primary..... A-8665M
Fuel Filter..... FC-5517
Fuel/Water Separator Secondary.. SFC-5504-10
Fuel/Water Separator Secondary.. SFC-5504-10B
Hydraulic Oil Filter..... HC-55170
Hydraulic Oil Filter..... HC-5505
Hydraulic Oil Filter..... HC-5801
Oil Filter Full Flow..... C-5516

TK370
(FELLER BUNCHERS)
CAT 3126 (S/N: WBD1-UP)
Air Filter Primary..... A-5558
Air Filter Secondary..... A-5559
Fuel Filter..... FC-5516
Fuel Filter Secondary..... FC-55151

MODEL/APPLICATION	SAKURA NO
-------------------	-----------

CATERPILLAR

Fuel Filter Secondary..... FC-5515
Fuel Filter..... FC-5508
Hydraulic Oil Filter..... HC-55300
Oil Filter Full Flow..... C-5510

TK371
(FELLER BUNCHERS)
CAT S/N: 55K12201-UP
Air Filter Secondary..... A-5559
Air Filter Primary..... A-5558
Fuel Filter..... FC-5508
Fuel Filter Secondary..... FC-5515
Fuel Filter Secondary..... FC-55151
Fuel Filter..... FC-5516
Hydraulic Oil Filter..... HC-55300
Hydraulic Oil Filter..... HC-5504
Oil Filter Full Flow..... C-5522

TK371
(FELLER BUNCHERS)
CAT S/N: WBG1-UP
Air Filter Primary..... A-5558
Air Filter Secondary..... A-5559
Fuel Filter..... FC-5516
Fuel Filter Secondary..... FC-55151
Fuel Filter Secondary..... FC-5515
Fuel Filter..... FC-5508
Hydraulic Oil Filter..... HC-5504
Hydraulic Oil Filter..... HC-55300
Oil Filter Full Flow..... C-5522

TK381
(FELLER BUNCHERS)
CAT S/N: 55K12115-UP
Air Filter Primary..... A-5558
Air Filter Secondary..... A-5559
Fuel Filter..... FC-5516
Fuel Filter Secondary..... FC-55151
Fuel Filter Secondary..... FC-5515
Fuel Filter..... FC-5508
Hydraulic Oil Filter..... HC-5504
Hydraulic Oil Filter..... HC-55300
Oil Filter Full Flow..... C-5522

TK381
(FELLER BUNCHERS)
CAT S/N: WBH1-UP
Air Filter Secondary..... A-5559
Air Filter Primary..... A-5558
Fuel Filter..... FC-5508
Fuel Filter Secondary..... FC-5515
Fuel Filter Secondary..... FC-55151
Fuel Filter..... FC-5516
Hydraulic Oil Filter..... HC-55300
Hydraulic Oil Filter..... HC-5504
Oil Filter Full Flow..... C-5522

TK711
(FELLER BUNCHERS)
CAT C9 (S/N: 101-1-UP)
Air Filter Secondary..... A-8651
Fuel Filter..... FC-5517
Hydraulic Oil Filter..... H-5509
Hydraulic Oil Filter..... HC-5801
Hydraulic Oil Filter..... HC-55170
Oil Filter Full Flow..... C-5516

TK741
(FELLER BUNCHERS)
CAT (S/N: THX1-UP)
Fuel Filter..... FC-5517

MODEL/APPLICATION	SAKURA NO
-------------------	-----------

CATERPILLAR

TK741
(FELLER BUNCHERS)
S/N: 2021-224-UP
Air Filter Secondary..... A-8651
Hydraulic Oil Filter..... HC-55170
Hydraulic Oil Filter..... H-5509
Hydraulic Oil Filter..... HC-5801

TK741
(FELLER BUNCHERS)
S/N: 202225-UP
Air Filter Secondary..... A-8651
Air Filter..... A-5584
Hydraulic Oil Filter..... HC-5801
Hydraulic Oil Filter..... H-5509
Hydraulic Oil Filter..... HC-55170

TK751
(FELLER BUNCHERS)
S/N: 3011-324-UP
Air Filter Secondary..... A-8651
Fuel Filter..... FC-5517
Hydraulic Oil Filter..... H-5509
Hydraulic Oil Filter..... HC-5801
Hydraulic Oil Filter..... HC-55170

TK751
(FELLER BUNCHERS)
S/N: 301325-UP
Air Filter Secondary..... A-8651
Air Filter..... A-5584
Fuel Filter..... FC-5517
Hydraulic Oil Filter..... HC-55170
Hydraulic Oil Filter..... HC-5801
Hydraulic Oil Filter..... H-5509

TK751
(FELLER BUNCHERS)
S/N: 3021-424-UP
Air Filter Secondary..... A-8651
Fuel Filter..... FC-5517
Hydraulic Oil Filter..... H-5509
Hydraulic Oil Filter..... HC-5801
Hydraulic Oil Filter..... HC-55170

TK751
(FELLER BUNCHERS)
S/N: 302425-UP
Air Filter Secondary..... A-8651
Air Filter..... A-5584
Fuel Filter..... FC-5517
Hydraulic Oil Filter..... HC-55170
Hydraulic Oil Filter..... HC-5801
Hydraulic Oil Filter..... H-5509

TR225B
(ROAD RECLAIMER)
S/N: 6WC1-UP
Air Filter Primary..... A-6113
Fuel Filter Secondary..... FC-5507
Oil Filter Full Flow..... C-5519

TR500
(ROAD RECLAIMER)
S/N: 8CC1-UP
Air Filter..... A-5553
Air Filter..... A-85410
Fuel Filter Secondary..... FC-5507
Fuel Filter..... FC-5502
Oil Filter Full Flow..... C-5519

V100F-VC110F
(FORKLIFTS)
PERKINS 4.236 (S/N: 6LG-UP)

MODEL/APPLICATION	SAKURA NO	MODEL/APPLICATION	SAKURA NO	MODEL/APPLICATION	SAKURA NO
CATERPILLAR		CATERPILLAR		CATERPILLAR	
V100F-VC110F (FORKLIFTS) PERKINS 4.236 (S/N: 6LG-UP) Air Filter Set..... A-5579-S Air Filter Set..... A-5578-S Air Filter Primary..... A-5577 Air Filter Secondary..... A-5576 Hydraulic Oil Filter Transmission... HC-5501 Oil Filter Full Flow..... C-5101		V100-V150 (FORKLIFTS) PERKINS 4.236 GAS (S/N: 60W-UP) Air Filter Secondary..... A-5576 Air Filter Primary..... A-5577 Air Filter Set..... A-5578-S Air Filter Set..... A-5579-S Hydraulic Oil Filter Transmission... H-5517 Hydraulic Oil Filter Transmission... HC-5501		Oil Filter Full Flow..... C-5519 V160-V180 (FORKLIFTS) CAT 3145 (S/N: 16V-UP) Oil Filter Full Flow..... C-5504 V160-V180 (FORKLIFTS) CAT 3145 (S/N: 17V-UP) Oil Filter Full Flow..... C-5504 V160-V180 (FORKLIFTS) CAT DIESEL (S/N: 16V-UP) Oil Filter Full Flow..... C-5504 V160-V180 (FORKLIFTS) CAT DIESEL (S/N: 17V-UP) Oil Filter Full Flow..... C-5504 V160-V180 (FORKLIFTS) PERKINS 6.354 (S/N: 18W-UP) Air Filter Primary..... A-6211 Fuel Filter..... FC-5103 Oil Filter Full Flow..... C-5101	
V100F-VC110F (FORKLIFTS) PERKINS 4.236 GAS (S/N: 6LG-UP) Air Filter Secondary..... A-5576 Air Filter Primary..... A-5577 Air Filter Set..... A-5578-S Air Filter Set..... A-5579-S Hydraulic Oil Filter Transmission... HC-5501 Oil Filter Full Flow..... C-5101		V1100 CTH (FORKLIFTS) CAT 3208DSL (S/N: 6BF-UP) Air Filter Set..... A-55071-S Air Filter Set..... A-5507-S Air Filter Primary..... A-5507 Air Filter..... A-5530 Hydraulic Oil Filter..... H-5517 Hydraulic Oil Filter..... H-5504 Oil Filter Full Flow..... C-5504 Oil Filter Full Flow..... C-5519 Oil Filter Full Flow..... C-5505		V160-V180 (FORKLIFTS) CAT DIESEL (S/N: 17V-UP) Oil Filter Full Flow..... C-5504 V160-V180 (FORKLIFTS) PERKINS 6.354 (S/N: 18W-UP) Air Filter Primary..... A-6211 Fuel Filter..... FC-5103 Oil Filter Full Flow..... C-5101	
V100F-VC110F (FORKLIFTS) PERKINS 4.2482 DIESEL (S/N: 1FK-UP) Air Filter Secondary..... A-5576 Air Filter Set..... A-5579-S Air Filter Set..... A-5578-S Air Filter Primary..... A-5577 Fuel Filter..... FC-5103 Hydraulic Oil Filter Transmission... HC-5501 Oil Filter Full Flow..... C-5101		V110B-V155B (FORKLIFTS) PERKINS 4.236 DIESEL (S/N: 3WG-UP) Air Filter Set..... A-5579-S Air Filter Set..... A-5578-S Air Filter Primary..... A-5577 Air Filter Secondary..... A-5576 Fuel Filter..... FC-5103 Hydraulic Oil Filter..... H-5517 Oil Filter Full Flow..... C-5101		V160-V180 (FORKLIFTS) PERKINS 6.354 (S/N: 63D-UP) Air Filter Primary..... A-6211 Fuel Filter..... FC-5103 Oil Filter Full Flow..... C-5101	
V100-V150 (FORKLIFTS) PERKINS 4.236 DIESEL (S/N: 55D-UP) Air Filter Secondary..... A-5576 Air Filter Primary..... A-5577 Air Filter Set..... A-5578-S Air Filter Set..... A-5579-S Fuel Filter..... FC-5103		V160B-V200B (FORKLIFTS) CAT 3208 (S/N: 67Y-UP) Air Filter..... A-5530 Air Filter Primary..... A-5507 Air Filter Set..... A-5507-S Air Filter Set..... A-55071-S Hydraulic Oil Filter..... H-5517 Oil Filter Full Flow..... C-5504 Oil Filter Full Flow..... C-5505 Oil Filter Full Flow..... C-5519		V180B (FORKLIFTS) CAT 3208 Air Filter Primary..... A-5509 Air Filter Secondary..... A-5510 Air Filter Set..... A-5522-S Oil Filter Full Flow..... C-5504 Oil Filter Full Flow..... C-5519 Oil Filter Full Flow..... C-5505	
V100-V150 (FORKLIFTS) PERKINS 4.236 DIESEL (S/N: 60D-UP) Air Filter Set..... A-5579-S Air Filter Set..... A-5578-S Air Filter Primary..... A-5577 Air Filter Secondary..... A-5576 Fuel Filter..... FC-5103 Hydraulic Oil Filter..... H-5640		V160B-V200B (FORKLIFTS) CAT 3208 (S/N: 84Y-UP) Air Filter Set..... A-55071-S Air Filter Set..... A-5507-S Air Filter Primary..... A-5507 Air Filter..... A-5530 Hydraulic Oil Filter..... H-5504 Oil Filter Full Flow..... C-5519 Oil Filter Full Flow..... C-5505 Oil Filter Full Flow..... C-5504		V180B (FORKLIFTS) CAT 3208 (S/N: 68Y00292-UP) Air Filter Set..... A-5522-S Air Filter Secondary..... A-5510 Air Filter Primary..... A-5509 Oil Filter Full Flow..... C-5505 Oil Filter Full Flow..... C-5519 Oil Filter Full Flow..... C-5504	
V100-V150 (FORKLIFTS) PERKINS 4.236 DIESEL (S/N: 8EF-UP) Air Filter Secondary..... A-5576 Air Filter Primary..... A-5577 Air Filter Set..... A-5578-S Air Filter Set..... A-5579-S Fuel Filter..... FC-5103 Hydraulic Oil Filter..... H-5517 Hydraulic Oil Filter Transmission... HC-5501 Oil Filter Full Flow..... C-5101		V160B-V200B (FORKLIFTS) CAT 3208 (S/N: 9AF-UP) Air Filter..... A-5530 Air Filter Primary..... A-5507 Air Filter Set..... A-5507-S Air Filter Set..... A-55071-S Hydraulic Oil Filter..... H-5517 Hydraulic Oil Filter..... H-5504 Oil Filter Full Flow..... C-5504 Oil Filter Full Flow..... C-5504 Oil Filter Full Flow..... C-5505		V200B-V225B (FORKLIFTS) CAT 3208 (S/N: 1DK-UP) Air Filter..... A-5530 Air Filter Set..... A-55071-S Air Filter Set..... A-5507-S Air Filter Primary..... A-5507 Fuel Filter..... FC-5103 Oil Filter Full Flow..... C-5505 Oil Filter Full Flow..... C-5519 Oil Filter Full Flow..... C-5504 Oil Filter Full Flow..... C-5101	
V100-V150 (FORKLIFTS) PERKINS 4.236 GAS (S/N: 59W-UP) Air Filter Set..... A-5579-S Air Filter Set..... A-5578-S Air Filter Primary..... A-5577 Air Filter Secondary..... A-5576 Hydraulic Oil Filter..... H-5517		V160B-V200B (FORKLIFTS) CAT 3208 (S/N: 69Y-UP) Air Filter..... A-5530 Air Filter Primary..... A-5507 Air Filter Set..... A-5507-S Air Filter Set..... A-55071-S Hydraulic Oil Filter..... H-5517 Hydraulic Oil Filter..... H-5504 Oil Filter Full Flow..... C-5504 Oil Filter Full Flow..... C-5505		V200B-V225B (FORKLIFTS) CAT 3208 (S/N: 69Y-UP) Air Filter..... A-5530 Air Filter Primary..... A-5507 Air Filter Set..... A-5507-S Air Filter Set..... A-55071-S Hydraulic Oil Filter..... H-5517	

Sakura Filter

ENGINE APPLICATION

MODEL/APPLICATION	SAKURA NO	MODEL/APPLICATION	SAKURA NO	MODEL/APPLICATION	SAKURA NO
CATERPILLAR		CATERPILLAR		CATERPILLAR	
V200B-V225B (<i>FORKLIFTS</i>) CAT 3208 (S/N: 69Y-UP)		Oil Filter Full Flow.....	C-5504	V30B-V60B (<i>FORKLIFTS</i>) CONTINEL F-163 (S/N: TO-32N00445)	
Oil Filter Full Flow.....	C-5504			Hydraulic Oil Filter.....	H-79411
Oil Filter Full Flow.....	C-5519	V250-V300 (<i>FORKLIFTS</i>) CAT 3145 (S/N: 24V-UP)		V30B-V60B (<i>FORKLIFTS</i>) CONTINEL F-163 (S/N: TO-33N00531)	
Oil Filter Full Flow.....	C-5505	Oil Filter Full Flow.....	C-5504	Hydraulic Oil Filter.....	H-79411
V200B-V225B (<i>FORKLIFTS</i>) CAT 3208 (S/N: 85V-UP)		V250-V300 (<i>FORKLIFTS</i>) CAT 3145 (S/N: 25V-UP)		V30B-V60B (<i>FORKLIFTS</i>) CONTINEL F-163 (S/N: TO-36N00427)	
Air Filter.....	A-5530	Oil Filter Full Flow.....	C-5504	Hydraulic Oil Filter.....	H-79411
Air Filter Set.....	A-55071-S	V250-V300 (<i>FORKLIFTS</i>) CAT DIESEL (S/N: 24V-UP)		V30B-V60B (<i>FORKLIFTS</i>) CONTINEL F-163 (S/N: TO-79M00948)	
Air Filter Set.....	A-5507-S	Oil Filter Full Flow.....	C-5504	Hydraulic Oil Filter.....	H-79411
Air Filter Primary.....	A-5507	V250-V300 (<i>FORKLIFTS</i>) CAT DIESEL (S/N: 25V-UP)		V30B-V60B (<i>FORKLIFTS</i>) CONTINEL F-163 GAS (S/N: 32N00446-UP)	
Hydraulic Oil Filter.....	H-5504	Air Filter Primary.....	A-6211	Air Filter.....	A-5424
Oil Filter Full Flow.....	C-5505	Fuel Filter.....	FC-5103	Hydraulic Oil Filter.....	H-79411
Oil Filter Full Flow.....	C-5519	Oil Filter Full Flow.....	C-5101	V30B-V60B (<i>FORKLIFTS</i>) CONTINEL F-163 GAS (S/N: 33N00532-UP)	
Oil Filter Full Flow.....	C-5504	V250-V300 (<i>FORKLIFTS</i>) PERKINS 6.354 DIESEL (S/N: 10F-UP)		Air Filter.....	A-5424
V200-V225 (<i>FORKLIFTS</i>) CAT 3145 (S/N: 20V-UP)		Air Filter Primary.....	A-6211	Hydraulic Oil Filter.....	H-79411
Oil Filter Full Flow.....	C-5504	Fuel Filter.....	FC-5103	V30B-V60B (<i>FORKLIFTS</i>) CONTINEL F-163 GAS (S/N: 54R-54R)	
V200-V225 (<i>FORKLIFTS</i>) CAT 3145 (S/N: 21V-UP)		Oil Filter Full Flow.....	C-5101	Air Filter.....	A-5424
Oil Filter Full Flow.....	C-5504	V250-V300 (<i>FORKLIFTS</i>) PERKINS 6.354 DIESEL (S/N: 98W-UP)		Hydraulic Oil Filter.....	H-79411
V200-V225 (<i>FORKLIFTS</i>) CAT DIESEL (S/N: 20V-UP)		Air Filter Primary.....	A-6211	V30B-V60B (<i>FORKLIFTS</i>) CONTINEL F-163 GAS (S/N: 72P-72P)	
Oil Filter Full Flow.....	C-5504	Fuel Filter.....	FC-5103	Air Filter.....	A-5424
V200-V225 (<i>FORKLIFTS</i>) CAT DIESEL (S/N: 21V-UP)		Oil Filter Full Flow.....	C-5101	Hydraulic Oil Filter.....	H-79411
Oil Filter Full Flow.....	C-5504	V25D-VC40D (<i>FORKLIFTS</i>) PEUGEOT XD3P DIESEL (S/N: 5JB-UP)		V30B-V60B (<i>FORKLIFTS</i>) CONTINEL F-163 GAS (S/N: 81M00788-81M01316)	
V200-V225 (<i>FORKLIFTS</i>) CAT DIESEL (S/N: 21V-UP)		Fuel Filter.....	FC-5101	Hydraulic Oil Filter.....	H-79411
Oil Filter Full Flow.....	C-5504	Hydraulic Oil Filter Transmission....	HC-5501	V30B-V60B (<i>FORKLIFTS</i>) CONTINEL F-163 GAS (S/N: 79M00949-UP)	
V200-V225 (<i>FORKLIFTS</i>) PERKINS 6.354 (S/N: 62E-UP)		Oil Filter Full Flow.....	C-1005	Air Filter.....	A-5424
Air Filter Primary.....	A-6211	V25D-VC40D (<i>FORKLIFTS</i>) PEUGEOT XN1P (S/N: 5HB-UP)		Hydraulic Oil Filter.....	H-79411
Fuel Filter.....	FC-5103	Hydraulic Oil Filter Transmission....	HC-5501	V30B-V60B (<i>FORKLIFTS</i>) CONTINEL F-163 GAS (S/N: 81M01317-81M02459)	
Oil Filter Full Flow.....	C-5101	Oil Filter Full Flow.....	C-1005	Air Filter.....	A-5424
V200-V225 (<i>FORKLIFTS</i>) PERKINS 6.354 DIESEL (S/N: 63E-UP)		V30B-V60B (<i>FORKLIFTS</i>) CONTINEL F-163 (S/N: 32N00446-UP)		Hydraulic Oil Filter.....	H-79411
Air Filter Primary.....	A-6211	Air Filter.....	A-5424	V30B-V60B (<i>FORKLIFTS</i>) CONTINEL F-163 GAS (S/N: TO-32N00445)	
Fuel Filter.....	FC-5103	Hydraulic Oil Filter.....	H-79411	Hydraulic Oil Filter.....	H-79411
Oil Filter Full Flow.....	C-5101	V30B-V60B (<i>FORKLIFTS</i>) CONTINEL F-163 (S/N: 33N00532-UP)		V30B-V60B (<i>FORKLIFTS</i>) CONTINEL F-163 GAS (S/N: TO-32N00445)	
V250B-V330B (<i>FORKLIFTS</i>) CAT 3208 (S/N: 71Y-UP)		Air Filter.....	A-5424	Hydraulic Oil Filter.....	H-79411
Air Filter Primary.....	A-5507	Hydraulic Oil Filter.....	H-79411	V30B-V60B (<i>FORKLIFTS</i>) CONTINEL F-163 GAS (S/N: TO-33N00531)	
Air Filter Set.....	A-5507-S	V30B-V60B (<i>FORKLIFTS</i>) CONTINEL F-163 (S/N: 79M00949-UP)		Hydraulic Oil Filter.....	H-79411
Air Filter Set.....	A-55071-S	Air Filter.....	A-5424	V30B-V60B (<i>FORKLIFTS</i>) CONTINEL F-163 GAS (S/N: TO-79M00948)	
Air Filter.....	A-5530	Hydraulic Oil Filter.....	H-79411	Hydraulic Oil Filter.....	H-79411
Hydraulic Oil Filter.....	H-5517	V30B-V60B (<i>FORKLIFTS</i>) CONTINEL F-163 (S/N: 81M00788-81M01316)		V30B-V60B (<i>FORKLIFTS</i>) CONTINEL F-227 (S/N: 37N00462-37N00563)	
Oil Filter Full Flow.....	C-5504	Hydraulic Oil Filter.....	H-79411	Hydraulic Oil Filter.....	H-79411
Oil Filter Full Flow.....	C-5519	V30B-V60B (<i>FORKLIFTS</i>) CONTINEL F-163 (S/N: 81M01317-81M02459)		V30B-V60B (<i>FORKLIFTS</i>) CONTINEL F-227 (S/N: 84M-84M)	
Oil Filter Full Flow.....	C-5505	Air Filter.....	A-5424	Hydraulic Oil Filter.....	H-79411
V250B-V330B (<i>FORKLIFTS</i>) CAT 3208 (S/N: 86Y-UP)		Hydraulic Oil Filter.....	H-79411	V30B-V60B (<i>FORKLIFTS</i>) CONTINEL F-227 (S/N: 84M-84M)	
Air Filter.....	A-5530	V30B-V60B (<i>FORKLIFTS</i>) CONTINEL F-163 (S/N: 81M00788-81M01316)		Hydraulic Oil Filter.....	H-79411
Air Filter Set.....	A-55071-S	Hydraulic Oil Filter.....	H-79411	V30B-V60B (<i>FORKLIFTS</i>) CONTINEL F-227 (S/N: 84M-84M)	
Air Filter Set.....	A-5507-S	V30B-V60B (<i>FORKLIFTS</i>) CONTINEL F-163 (S/N: 81M01317-81M02459)		Hydraulic Oil Filter.....	H-79411
Air Filter Primary.....	A-5507	Air Filter.....	A-5424	V30B-V60B (<i>FORKLIFTS</i>) CONTINEL F-227 (S/N: 84M-84M)	
Hydraulic Oil Filter.....	H-5517	Hydraulic Oil Filter.....	H-79411	Hydraulic Oil Filter.....	H-79411
Hydraulic Oil Filter.....	H-5504	V30B-V60B (<i>FORKLIFTS</i>) CONTINEL F-163 (S/N: 81M01317-81M02459)			
Oil Filter Full Flow.....	C-5505	Air Filter.....	A-5424		
Oil Filter Full Flow.....	C-5519	Hydraulic Oil Filter.....	H-79411		

Sakura Filter

ENGINE APPLICATION

MODEL/APPLICATION	SAKURA NO	MODEL/APPLICATION	SAKURA NO	MODEL/APPLICATION	SAKURA NO
CATERPILLAR		CATERPILLAR		CATERPILLAR	
V30B-V60B (<i>FORKLIFTS</i>) CONTINEL F-227 (S/N: 89M00641-89M00942) Hydraulic Oil Filter.....	H-79411	Oil Filter Full Flow.....	C-5101	Hydraulic Oil Filter Transmission....	HC-5501
V30B-V60B (<i>FORKLIFTS</i>) CONTINEL F-227 (S/N: TO-36N00427) Hydraulic Oil Filter.....	H-79411	V30B-V60B (<i>FORKLIFTS</i>) PERKINS 4.236 DIESEL (S/N: TO-83M00456) Fuel Filter.....	FC-5103	V30C-VC60C (<i>FORKLIFTS</i>) CONTINEL F-227 GAS (S/N: 45U-UP)	A-5579-S
V30B-V60B (<i>FORKLIFTS</i>) CONTINEL F-227 (S/N: TO-87M00736) Hydraulic Oil Filter.....	H-79411	Hydraulic Oil Filter.....	H-79411	Air Filter Set.....	A-5578-S
V30B-V60B (<i>FORKLIFTS</i>) CONTINEL F-227 GAS (S/N: 35N00474-UP) Air Filter.....	A-5424	Oil Filter Full Flow.....	C-5101	Air Filter Primary.....	A-5577
Hydraulic Oil Filter.....	H-79411	V30C-VC60C (<i>FORKLIFTS</i>) CAT 1404 GAS (S/N: 10U-UP)	A-5579-S	Air Filter Secondary.....	A-5576
V30B-V60B (<i>FORKLIFTS</i>) CONTINEL F-227 GAS (S/N: 36N00428-36N00473) Hydraulic Oil Filter.....	H-79411	Air Filter Primary.....	A-5577	Air Filter Set.....	A-5578-S
V30B-V60B (<i>FORKLIFTS</i>) CONTINEL F-227 GAS (S/N: 37N00564-37N00662) Hydraulic Oil Filter.....	H-79411	Air Filter Set.....	A-5579-S	Air Filter Set.....	A-5578-S
V30B-V60B (<i>FORKLIFTS</i>) CONTINEL F-227 GAS (S/N: 59R-59R) Air Filter.....	A-5424	Hydraulic Oil Filter Transmission....	HC-5501	Air Filter Set.....	A-5579-S
V30B-V60B (<i>FORKLIFTS</i>) CONTINEL F-227 GAS (S/N: 75P-75P) Air Filter.....	A-5424	Oil Filter Full Flow.....	C-5504	Air Filter Set.....	A-5578-S
Hydraulic Oil Filter.....	H-79411	V30C-VC60C (<i>FORKLIFTS</i>) CAT 1404 GAS (S/N: 20R-UP)	A-5579-S	Air Filter Primary.....	A-5577
V30B-V60B (<i>FORKLIFTS</i>) CONTINEL F-227 GAS (S/N: 87M00764-UP) Hydraulic Oil Filter.....	H-79411	Air Filter Set.....	A-5578-S	Air Filter Secondary.....	A-5576
V30B-V60B (<i>FORKLIFTS</i>) CONTINEL F-227 GAS (S/N: 89M00943-89M01751) Hydraulic Oil Filter.....	H-79411	Air Filter Primary.....	A-5577	Fuel Filter.....	FC-5103
V30B-V60B (<i>FORKLIFTS</i>) PERKINS 4.236 DIESEL (S/N: 52J00616-UP) Fuel Filter.....	FC-5103	Air Filter Secondary.....	A-5576	Hydraulic Oil Filter.....	H-79411
Hydraulic Oil Filter.....	H-79411	Oil Filter Full Flow.....	C-5504	Oil Filter Full Flow.....	C-5101
Oil Filter Full Flow.....	C-5101	V30C-VC60C (<i>FORKLIFTS</i>) CAT 1404 GAS (S/N: 45Y-UP)	A-5579-S	V30C-VC60C (<i>FORKLIFTS</i>) PERKINS 4.2032 DIESEL (S/N: 58Y-UP)	A-5579-S
V30B-V60B (<i>FORKLIFTS</i>) PERKINS 4.236 DIESEL (S/N: 56R-56R) Fuel Filter.....	FC-5103	Air Filter Primary.....	A-5577	Air Filter Secondary.....	A-5576
Oil Filter Full Flow.....	C-5101	Air Filter Set.....	A-5578-S	Air Filter Primary.....	A-5577
V30B-V60B (<i>FORKLIFTS</i>) PERKINS 4.236 DIESEL (S/N: 77P-77P) Fuel Filter.....	FC-5103	Air Filter Secondary.....	A-5576	Air Filter Set.....	A-5578-S
Hydraulic Oil Filter.....	H-79411	Hydraulic Oil Filter.....	H-79411	Air Filter Primary.....	A-5577
Oil Filter Full Flow.....	C-5101	Oil Filter Full Flow.....	C-5504	Air Filter Secondary.....	A-5576
V30B-V60B (<i>FORKLIFTS</i>) PERKINS 4.236 DIESEL (S/N: 83M00457-UP) Fuel Filter.....	FC-5103	V30C-VC60C (<i>FORKLIFTS</i>) CONTINEL F-227 (S/N: 77U-UP)	A-5579-S	Fuel Filter.....	FC-5103
Hydraulic Oil Filter.....	H-79411	Air Filter Set.....	A-5578-S	Hydraulic Oil Filter Transmission....	HC-5501
Oil Filter Full Flow.....	C-5101	Air Filter Primary.....	A-5577	Oil Filter Full Flow.....	C-5101
V30B-V60B (<i>FORKLIFTS</i>) PERKINS 4.236 DIESEL (S/N: TO-52J00615) Fuel Filter.....	FC-5103	Air Filter Secondary.....	A-5576	V30C-VC60C (<i>FORKLIFTS</i>) PERKINS 4.2032 DIESEL (S/N: 95W-UP)	A-5579-S
Hydraulic Oil Filter.....	H-79411	Hydraulic Oil Filter.....	H-79411	Air Filter Secondary.....	A-5576
Oil Filter Full Flow.....	C-5101	V30C-VC60C (<i>FORKLIFTS</i>) CONTINEL F-227 GAS (S/N: 39U-UP)	A-5579-S	Air Filter Primary.....	A-5577
V30B-V60B (<i>FORKLIFTS</i>) PERKINS 4.236 DIESEL (S/N: TO-52J00615) Fuel Filter.....	FC-5103	Air Filter Set.....	A-5578-S	Air Filter Set.....	A-5578-S
Hydraulic Oil Filter.....	H-79411	Air Filter Primary.....	A-5577	Air Filter Primary.....	A-5577
Oil Filter Full Flow.....	C-5101	Air Filter Set.....	A-5579-S	Air Filter Secondary.....	A-5576
V30B-V60B (<i>FORKLIFTS</i>) PERKINS 4.236 DIESEL (S/N: TO-52J00615) Fuel Filter.....	FC-5103	Oil Filter Full Flow.....	C-5504	Fuel Filter.....	FC-5103
Hydraulic Oil Filter.....	H-79411	V30C-VC60C (<i>FORKLIFTS</i>) CAT 1404 GAS (S/N: 96P-UP)	A-5579-S	Hydraulic Oil Filter Transmission....	HC-5501
V30B-V60B (<i>FORKLIFTS</i>) PERKINS 4.236 DIESEL (S/N: TO-52J00615) Fuel Filter.....	FC-5103	Air Filter Secondary.....	A-5576	Oil Filter Full Flow.....	C-5101
Hydraulic Oil Filter.....	H-79411	Air Filter Primary.....	A-5577	V30C-VC60C (<i>FORKLIFTS</i>) PERKINS 4.236 DIESEL (S/N: 41U-UP)	A-5579-S
Oil Filter Full Flow.....	C-5101	Air Filter Set.....	A-5578-S	Air Filter Set.....	A-5578-S
V30B-V60B (<i>FORKLIFTS</i>) PERKINS 4.236 DIESEL (S/N: TO-52J00615) Fuel Filter.....	FC-5103	Air Filter Secondary.....	A-5576	Air Filter Primary.....	A-5577
Hydraulic Oil Filter.....	H-79411	Hydraulic Oil Filter.....	H-79411	Air Filter Secondary.....	A-5576
Oil Filter Full Flow.....	C-5101	V30C-VC60C (<i>FORKLIFTS</i>) CONTINEL F-227 GAS (S/N: 39U-UP)	A-5579-S	Fuel Filter.....	FC-5103
V30B-V60B (<i>FORKLIFTS</i>) PERKINS 4.236 DIESEL (S/N: TO-52J00615) Fuel Filter.....	FC-5103	Air Filter Set.....	A-5578-S	Hydraulic Oil Filter Transmission....	HC-5501
Hydraulic Oil Filter.....	H-79411	Air Filter Primary.....	A-5577	Oil Filter Full Flow.....	C-5101
Oil Filter Full Flow.....	C-5101	Air Filter Set.....	A-5579-S	V30C-VC60C (<i>FORKLIFTS</i>) PERKINS 4.236 DIESEL (S/N: 43U-UP)	A-5579-S

MODEL/APPLICATION	SAKURA NO	MODEL/APPLICATION	SAKURA NO	MODEL/APPLICATION	SAKURA NO
CATERPILLAR		CATERPILLAR		CATERPILLAR	
V30C-VC60C (<i>FORKLIFTS</i>) PERKINS 4.236 DIESEL (S/N: 43U-UP)		Air Filter Set.....	A-5579-S	V60D-V80D (<i>FORKLIFTS</i>) PERKINS 4.236 (S/N: 74X-UP)	
Air Filter Secondary.....	A-5576	Air Filter Primary.....	A-5577	Air Filter Set.....	A-5579-S
Air Filter Primary.....	A-5577	Air Filter Secondary.....	A-5576	Air Filter Set.....	A-5578-S
Air Filter Set.....	A-5578-S	Hydraulic Oil Filter Transmission...	HC-5501	Air Filter Primary.....	A-5577
Air Filter Set.....	A-5579-S	Oil Filter Full Flow.....	C-5504	Air Filter Secondary.....	A-5576
Fuel Filter.....	FC-5103	V40D-VC60D (<i>FORKLIFTS</i>) PERKINS 4.2032 DIESEL (S/N: 5BC-UP)		V60D-V80D (<i>FORKLIFTS</i>) PERKINS 4.236 DIESEL (S/N: 75X-UP)	
Hydraulic Oil Filter.....	H-79411	Air Filter Secondary.....	A-5576	Air Filter Secondary.....	A-5576
Oil Filter Full Flow.....	C-5101	Air Filter Primary.....	A-5577	Air Filter Primary.....	A-5577
V30C-VC60C (<i>FORKLIFTS</i>) PERKINS 4.236 DIESEL (S/N: 44Y-UP)		Air Filter Set.....	A-5579-S	Air Filter Set.....	A-5578-S
Air Filter Set.....	A-5579-S	Air Filter Set.....	A-5578-S	Air Filter Set.....	A-5579-S
Air Filter Set.....	A-5578-S	Fuel Filter.....	FC-5103	Air Filter Set.....	A-5579-S
Air Filter Primary.....	A-5577	Hydraulic Oil Filter Transmission...	HC-5501	Fuel Filter.....	FC-5103
Air Filter Secondary.....	A-5576	Oil Filter Full Flow.....	C-5103	V60D-V80D (<i>FORKLIFTS</i>) PERKINS 4.236 GAS (S/N: 74X-UP)	
Fuel Filter.....	FC-5103	V40D-VC60D (<i>FORKLIFTS</i>) PEUGEOT XD3P DIESEL (S/N: 9RB-UP)		Air Filter Primary.....	A-5577
Oil Filter Full Flow.....	C-5101	Fuel Filter.....	FC-5101	Air Filter Secondary.....	A-5576
V30-V60 (<i>FORKLIFTS</i>) CONTINEL F-163 (S/N: 76M-UP)		Hydraulic Oil Filter Transmission...	HC-5501	Air Filter Set.....	A-5579-S
Hydraulic Oil Filter.....	H-79411	Oil Filter Full Flow.....	C-1005	Air Filter Set.....	A-5578-S
V30-V60 (<i>FORKLIFTS</i>) PERKINS 3.152 DIESEL (S/N: 57W-UP)		V40D-VC60D (<i>FORKLIFTS</i>) PEUGEOT XN1P (S/N: 3EC-UP)		V60E-V90E (<i>FORKLIFTS</i>) PERKINS 4.236 (S/N: 74X-UP)	
Fuel Filter.....	FC-5103	Hydraulic Oil Filter Transmission...	HC-5501	Air Filter Secondary.....	A-5576
Hydraulic Oil Filter.....	H-79411	Oil Filter Full Flow.....	C-1005	Air Filter Primary.....	A-5577
Oil Filter Full Flow.....	0-5001	V40D-VC60D (<i>FORKLIFTS</i>) PEUGEOT XN1P GAS (S/N: 3EC-UP)		Air Filter Set.....	A-5578-S
V30-V60 (<i>FORKLIFTS</i>) PERKINS 3.152 DIESEL (S/N: 87Y-UP)		Hydraulic Oil Filter Transmission...	HC-5501	Air Filter Set.....	A-5579-S
Fuel Filter.....	FC-5103	Oil Filter Full Flow.....	C-1005	V60E-V90E (<i>FORKLIFTS</i>) PERKINS 4.236 (S/N: 7LB-UP)	
Oil Filter Full Flow.....	0-5001	V50E (<i>FORKLIFTS</i>)		Air Filter Set.....	A-5579-S
V40D THRU VC60D SA (<i>FORKLIFTS</i>) CAT 1404		Air Filter Primary.....	A-5537	Air Filter Set.....	A-5578-S
Air Filter Set.....	A-5579-S	Air Filter Secondary.....	A-5536	Air Filter Primary.....	A-5577
Air Filter Set.....	A-5578-S	Air Filter Set.....	A-5537-S	Air Filter Secondary.....	A-5576
Air Filter Primary.....	A-5577	V550-V620 (<i>FORKLIFTS</i>) CAT 3208 (S/N: 2DD-UP)		V60E-V90E (<i>FORKLIFTS</i>) PERKINS 4.236 DIESEL (S/N: 58A-UP)	
Air Filter Secondary.....	A-5576	Air Filter Set.....	A-55071-S	Air Filter Secondary.....	A-5576
Hydraulic Oil Filter Transmission...	HC-5501	Air Filter Set.....	A-5507-S	Air Filter Set.....	A-5579-S
Oil Filter Full Flow.....	C-5504	Air Filter Primary.....	A-5507	Air Filter Primary.....	A-5577
V40D THRU VC60D SA (<i>FORKLIFTS</i>) PERKINS 4.2032		Air Filter.....	A-5530	Air Filter Set.....	A-5578-S
Air Filter Secondary.....	A-5576	Hydraulic Oil Filter.....	H-5504	Fuel Filter.....	FC-5103
Air Filter Primary.....	A-5577	Hydraulic Oil Filter.....	H-5517	V60E-V90E (<i>FORKLIFTS</i>) PERKINS 4.236 DIESEL (S/N: 88Y-UP)	
Air Filter Set.....	A-5578-S	Oil Filter Full Flow.....	C-5504	Air Filter Secondary.....	A-5576
Air Filter Set.....	A-5579-S	Oil Filter Full Flow.....	C-5505	Air Filter Set.....	A-5578-S
Fuel Filter.....	FC-5103	Oil Filter Full Flow.....	C-5519	Air Filter Primary.....	A-5577
Hydraulic Oil Filter Transmission...	HC-5501	V550-V620 (<i>FORKLIFTS</i>) CAT 3208 (S/N: 9SC-UP)		Air Filter Set.....	A-5579-S
Oil Filter Full Flow.....	C-5103	Air Filter.....	A-5530	Fuel Filter.....	FC-5103
V40D-VC60D (<i>FORKLIFTS</i>) CAT 1404 (S/N: 9SB-UP)		Air Filter Primary.....	A-5507	V60E-V90E (<i>FORKLIFTS</i>) PERKINS 4.236 GAS (S/N: 74X-UP)	
Air Filter Secondary.....	A-5576	Air Filter Set.....	A-5507-S	Air Filter Set.....	A-5579-S
Air Filter Primary.....	A-5577	Air Filter Set.....	A-55071-S	Air Filter Primary.....	A-5577
Air Filter Set.....	A-5579-S	Hydraulic Oil Filter.....	H-5517	Air Filter Set.....	A-5578-S
Air Filter Set.....	A-5578-S	Hydraulic Oil Filter.....	H-5504	Air Filter Secondary.....	A-5576
Fuel Filter.....	FC-5103	Oil Filter Full Flow.....	C-5519	V60E-V90E (<i>FORKLIFTS</i>) PERKINS 4.236 GAS (S/N: 7LB-UP)	
Hydraulic Oil Filter Transmission...	HC-5501	Oil Filter Full Flow.....	C-5505	Air Filter Secondary.....	A-5576
Oil Filter Full Flow.....	C-5103	Oil Filter Full Flow.....	C-5505	Air Filter Set.....	A-5578-S
V40D-VC60D (<i>FORKLIFTS</i>) CAT 1404 GAS (S/N: 9SB-UP)		Oil Filter Full Flow.....	C-5504	Air Filter Primary.....	A-5577
Air Filter Set.....	A-5578-S	V60C-V80C (<i>FORKLIFTS</i>) PERKINS 4.236 DIESEL (S/N: 35X-UP)		Air Filter Set.....	A-5579-S
V40D-VC60D (<i>FORKLIFTS</i>) PERKINS 4.236 DIESEL (S/N: 43U-UP)		Fuel Filter.....	FC-5103		

MODEL/APPLICATION	SAKURA NO	MODEL/APPLICATION	SAKURA NO	MODEL/APPLICATION	SAKURA NO
CATERPILLAR		CATERPILLAR		CATERPILLAR	
V700-V800 (<i>FORKLIFTS</i>) CAT 3208DSL (S/N: 5LC-UP)		Hydraulic Oil Filter.....	H-5504	Cabin Air Filter.....	CA-55850
Air Filter.....	A-5530	Oil Filter Full Flow.....	C-5519	Fuel Filter.....	FC-5510
Air Filter Primary.....	A-5507	Oil Filter Full Flow.....	C-5505	Hydraulic Oil Filter.....	H-5522
Air Filter Set.....	A-5507-S	Oil Filter Full Flow.....	C-5504	Hydraulic Oil Filter.....	HC-55170
Air Filter Set.....	A-55071-S			Hydraulic Oil Filter.....	H-7942
Hydraulic Oil Filter.....	H-5517	V925 LH (<i>FORKLIFTS</i>) CAT 3208DSL (S/N: 8NF-UP)		Hydraulic Oil Filter.....	HC-5504
Hydraulic Oil Filter.....	H-5504	Air Filter Set.....	A-55071-S	Hydraulic Oil Filter.....	HC-5801
Oil Filter Full Flow.....	C-5519	Air Filter Set.....	A-5507-S		
Oil Filter Full Flow.....	C-5505	Air Filter Primary.....	A-5507	W345C (<i>MATERIAL HANDLERS</i>) CAT S/N: MHX300-UP	
Oil Filter Full Flow.....	C-5504	Air Filter.....	A-5530	Air Filter Secondary.....	A-8580
		Hydraulic Oil Filter.....	H-5504	Air Filter Primary.....	A-8665M
V70F-V90F (<i>FORKLIFTS</i>) PERKINS 4.236 (S/N: 9NF-UP)		Hydraulic Oil Filter.....	H-5517	Cabin Air Filter.....	CA-55850
Air Filter Set.....	A-5579-S	Oil Filter Full Flow.....	C-5504	Fuel Filter.....	FC-5510
Air Filter Set.....	A-5578-S	Oil Filter Full Flow.....	C-5505	Hydraulic Oil Filter.....	HC-5504
Air Filter Primary.....	A-5577	Oil Filter Full Flow.....	C-5519	Hydraulic Oil Filter.....	H-7942
Air Filter Secondary.....	A-5580			Hydraulic Oil Filter.....	HC-55170
Hydraulic Oil Filter Transmission...	HC-5501	VC60C (<i>FORKLIFTS</i>)		Hydraulic Oil Filter.....	H-5522
Oil Filter Full Flow.....	C-5101	Hydraulic Oil Filter Transmission...	HC-5501	Hydraulic Oil Filter.....	HC-5801
V70F-V90F (<i>FORKLIFTS</i>) PERKINS 4.236 GAS (S/N: 9NF-UP)		VC60D SA (<i>FORKLIFTS</i>) CAT 1404		W345C (<i>MATERIAL HANDLERS</i>) CAT S/N: R5K1-UP	
Air Filter Set.....	A-5578-S	Air Filter Primary.....	A-5577	Air Filter Primary.....	A-8665M
Air Filter Secondary.....	A-5580	Air Filter Secondary.....	A-5576	Air Filter Secondary.....	A-8580
Air Filter Primary.....	A-5577	Air Filter Set.....	A-5578-S	Cabin Air Filter.....	CA-55850
Air Filter Set.....	A-5579-S	Air Filter Set.....	A-5579-S	Fuel Filter.....	FC-5510
Hydraulic Oil Filter Transmission...	HC-5501	Hydraulic Oil Filter Transmission...	HC-5501	Hydraulic Oil Filter.....	H-5522
Oil Filter Full Flow.....	C-5101	Oil Filter Full Flow.....	C-5504	Hydraulic Oil Filter.....	HC-55170
				Hydraulic Oil Filter.....	H-7942
V70F-V90F (<i>FORKLIFTS</i>) PERKINS 4.2482 DIESEL (S/N: 26J-UP)		VC60D SA (<i>FORKLIFTS</i>) PERKINS 4.2032		Hydraulic Oil Filter.....	HC-5504
Air Filter Set.....	A-5579-S	Air Filter Primary.....	A-5577	Hydraulic Oil Filter.....	HC-5801
Air Filter Primary.....	A-5577	Air Filter Set.....	A-5579-S	Oil Filter Full Flow.....	C-5516
Air Filter Secondary.....	A-5580	Air Filter Set.....	A-5578-S		
Air Filter Set.....	A-5578-S	Air Filter Secondary.....	A-5576	W345C (<i>MATERIAL HANDLERS</i>) CAT C13 ACERT	
Fuel Filter.....	FC-5103	Fuel Filter.....	FC-5103	Hydraulic Oil Filter.....	HC-9901
Hydraulic Oil Filter Transmission...	HC-5501	Hydraulic Oil Filter Transmission...	HC-5501		
Oil Filter Full Flow.....	C-5101			W345B II (<i>MATERIAL HANDLERS</i>) CAT S/N: 7ZE4253-4280-UP	
		W330B (<i>EXCAVATORS</i>) CAT 3306 (S/N: AME1-UP)		Fuel Filter.....	FC-5509
V900 CH (<i>FORKLIFTS</i>) CAT 3208		Air Filter Primary.....	A-5558	Fuel Filter.....	FC-5517
Air Filter Set.....	A-44180-S	Air Filter Secondary.....	A-5559	Oil Filter Full Flow.....	C-5516
Air Filter Primary.....	A-44180	Cabin Air Filter.....	CA-55850		
		Fuel Filter Secondary.....	FC-5507	W345B II (<i>MATERIAL HANDLERS</i>) CAT S/N: 7ZE4281-5544-UP	
V900 CH (<i>FORKLIFTS</i>) CAT 3208DSL (S/N: 3WD-UP)		Hydraulic Oil Filter.....	HC-5505	Fuel Filter.....	FC-5517
Air Filter.....	A-5530	Hydraulic Oil Filter.....	H-7942	Fuel Filter.....	FC-5509
Air Filter Set.....	A-55071-S	Hydraulic Oil Filter.....	HC-5801		
Air Filter Set.....	A-5507-S	Oil Filter Full Flow.....	C-5510	W345B II (<i>MATERIAL HANDLERS</i>) CAT S/N: 7ZR1-4252-UP	
Air Filter Primary.....	A-5507			Fuel Filter.....	FC-5509
Hydraulic Oil Filter.....	H-5504	W330B MH (<i>MATERIAL HANDLERS</i>) CAT 3306 (S/N: AME1-UP)		Fuel Filter.....	FC-5517
Hydraulic Oil Filter.....	H-5517	Air Filter Secondary.....	A-5559		
Oil Filter Full Flow.....	C-5504	Air Filter Primary.....	A-5558	W345B II (<i>MATERIAL HANDLERS</i>) CAT S/N: 7ZR5545-UP	
Oil Filter Full Flow.....	C-5505	Fuel Filter Secondary.....	FC-5507	Fuel Filter.....	FC-5509
Oil Filter Full Flow.....	C-5519	Fuel Filter.....	F-5505	Fuel Filter.....	FC-5517
		Hydraulic Oil Filter.....	HC-5801	Oil Filter Full Flow.....	C-5516
V925 (<i>FORKLIFTS</i>) CAT 3208DSL (S/N: 8FB-UP)		Hydraulic Oil Filter.....	H-7942		
Air Filter.....	A-5530	Hydraulic Oil Filter.....	HC-5505	W345B II (<i>MATERIAL HANDLERS</i>) S/N: ANJ1-UP	
Air Filter Primary.....	A-5507	Oil Filter Full Flow.....	C-5510	Air Filter Primary.....	A-5593
Air Filter Set.....	A-5507-S			Air Filter Set.....	A-5595-S
Air Filter Set.....	A-55071-S	W345C (<i>MATERIAL HANDLERS</i>) CAT S/N: M3M1-UP		Air Filter Secondary.....	A-5594
Hydraulic Oil Filter.....	H-5517	Air Filter Primary.....	A-8665M	Cabin Air Filter.....	CA-55850
		Air Filter Secondary.....	A-8580	Fuel/Water Separator Secondary...	SFC-5504-10
				Fuel/Water Separator Secondary..	SFC-5504-10B

MODEL/APPLICATION	SAKURA NO
CATERPILLAR	

W345B II

(*MATERIAL HANDLERS*)

S/N: ANJ1-UP

Hydraulic Oil Filter.....	HC-5801
Hydraulic Oil Filter.....	HC-5505
Hydraulic Oil Filter.....	H-7942
Hydraulic Oil Filter.....	HC-55170

W345B II

(*MATERIAL HANDLERS*)

S/N: CDY1-UP

Air Filter Secondary.....	A-5594
Air Filter Set.....	A-5595-S
Air Filter Primary.....	A-5593
Cabin Air Filter.....	CA-55850
Fuel/Water Separator Secondary..	SFC-5504-10B
Fuel/Water Separator Secondary..	SFC-5504-10
Hydraulic Oil Filter.....	HC-5801
Hydraulic Oil Filter.....	HC-55170
Hydraulic Oil Filter.....	H-7942
Hydraulic Oil Filter.....	HC-5505

W345B MH

(*MATERIAL HANDLERS*)

CAT 3176C (S/N: CDY1-UP)

Air Filter Secondary.....	A-5594
Air Filter Set.....	A-5595-S
Air Filter Primary.....	A-5593
Cabin Air Filter.....	CA-55850
Fuel Filter.....	FC-5517
Fuel/Water Separator Secondary..	SFC-5504-10B
Fuel/Water Separator Secondary..	SFC-5504-10
Hydraulic Oil Filter.....	HC-5801
Hydraulic Oil Filter.....	HC-5505
Hydraulic Oil Filter.....	H-7942
Oil Filter Full Flow.....	C-5516

W345BII MH

(*MATERIAL HANDLERS*)

CAT 3176C (S/N: ANJ1-UP)

Cabin Air Filter.....	CA-55850
Fuel Filter.....	FC-5517
Fuel/Water Separator Secondary..	SFC-5504-10
Fuel/Water Separator Secondary..	SFC-5504-10B
Hydraulic Oil Filter.....	H-7942
Hydraulic Oil Filter.....	HC-5505
Hydraulic Oil Filter.....	HC-5801
Oil Filter Full Flow.....	C-5516

WE601B

(*ASPHALT PAVER*)

S/N: 7EC1-UP

Oil Filter Full Flow.....	C-5101
---------------------------	--------

WE851B

(*ASPHALT PAVER*)

S/N: 8BC1-UP

Air Filter Primary.....	AS-5523
Oil Filter Full Flow.....	C-5101



Technical Specification

B

Sakura Filter

Technical Specification

A-1096 Air Filter Metal End Cap Element

MITSUBISHI 91361-00900
MITSUBISHI 91361-00901



H 1 : 228.9 (mm)
H 2 : 219 (mm)
OD 1 : 153 (mm)
OD 2 : 108 (mm)
ID 1 : 59 (mm)

CONT : 12
VOL : 0.113

A-28710 Air Filter Primary Metal End Cap Element

HYUNDAI 11N8-22140



Secondary Filter uses A-28720
Set Filter uses A-28730-S

H 1 : 502.75 (mm)
H 2 : 490 (mm)
OD 1 : 276 (mm)
OD 2 : 275 (mm)
ID 1 : 165 (mm)
ID 2 : 19 (mm)

CONT : 1
VOL : 0.045

A-4402 Air Filter Secondary Soft PU end cap Element

CATERPILLAR 180-5475



Primary Filter uses A-4401
Set Filter uses A-4401-S

H 1 : 311 (mm)
H 2 : 305 (mm)
OD 1 : 92 (mm)
OD 2 : 86.5 (mm)
ID 1 : 72.5 (mm)

CONT : 25
VOL : 0.097

A-2210 Air Filter Primary Metal End Cap Element

FIAT 0068473-3
ISUZU 1-14215-018-0
ISUZU 1-14215007-0
NISSAN 16546-96011



Secondary Filter uses A-6008
Set Filter uses A-6117-S

H 1 : 342.7 (mm)
H 2 : 330 (mm)
OD 1 : 234 (mm)
OD 2 : 234 (mm)
ID 1 : 123 (mm)
ID 2 : 17 (mm)

CONT : 4
VOL : 0.089

A-28730-S Air Filter Set Metal End Cap Element

HYUNDAI 11N8-22140+11N8-22150



Primary Filter uses A-28710
Secondary Filter uses A-28720

H 1 : 502.75 (mm)
H 2 : 490 (mm)
OD 1 : 276 (mm)
OD 2 : 275 (mm)
ID 1 : 134 (mm)
ID 2 : 19 (mm)

CONT : 1
VOL : 0.045

A-4403 Air Filter Metal End Cap Element

CATERPILLAR 4P-0710



H 1 : 364.2 (mm)
H 2 : 351.5 (mm)
OD 1 : 490 (mm)
OD 2 : 490 (mm)
ID 1 : 328.5 (mm)

CONT : 1
VOL : 0.104

Note : Long life filter uses A-5551

A-25460 Air Filter Metal End Cap Element

CATERPILLAR 1569328
RENAULT 5000541976
MACK 57MD27



H 1 : 405.5 (mm)
H 2 : 380 (mm)
OD 1 : 220 (mm)
OD 2 : 145 (mm)
ID 1 : 132 (mm)

CONT : 4
VOL : 0.099

A-4210 Air Filter Primary Soft PU end cap Element

KUBOTA 3P300-11220



Secondary Filter uses A-4211
Set Filter uses A-4212-S

H 1 : 293.8 (mm)
H 2 : 281 (mm)
OD 1 : 207 (mm)
OD 2 : 207 (mm)
ID 1 : 106.5 (mm)

CONT : 4
VOL : 0.069

Note : Alternate parts A-76600

A-4403-S Air Filter Set Metal End Cap Element

CATERPILLAR 4P-0710+4P-0711



Primary Filter uses A-4403
Secondary Filter uses A-5588

H 1 : 364 (mm)
H 2 : 351.5 (mm)
OD 1 : 490 (mm)
OD 2 : 490 (mm)
ID 1 : 257 (mm)

CONT : 1
VOL : 0.108

A-2705 Air Filter Secondary Soft PU end cap Element

HITACHI 4287060
KOBELCO YN02P000013B



Primary Filter uses A-2706
Set Filter uses A-2707-S

H 1 : 353 (mm)
H 2 : 347 (mm)
OD 1 : 124 (mm)
OD 2 : 117 (mm)
ID 1 : 104 (mm)

CONT : 25
VOL : 0.178

A-4211 Air Filter Secondary Soft PU end cap Element

KUBOTA 3P300-11230



Primary Filter uses A-4210
Set Filter uses A-4212-S

H 1 : 279.5 (mm)
H 2 : 274.5 (mm)
OD 1 : 107.5 (mm)
OD 2 : 101.5 (mm)
ID 1 : 89 (mm)

CONT : 25
VOL : 0.115

A-44150 Air Filter Primary Rigid PU end cap Element

CATERPILLAR 1P-7716
CATERPILLAR 7W-5495



Secondary Filter uses A-5502
Set Filter uses A-44150-S

H 1 : 343 (mm)
H 2 : 330 (mm)
OD 1 : 290.5 (mm)
OD 2 : 290.5 (mm)
ID 1 : 203.5 (mm)

CONT : 4
VOL : 0.140

Note : is a rigid PU version of A-5501

A-2706 Air Filter Primary Soft PU end cap Element

HITACHI 4283861
KOBELCO YN02P000013A



Secondary Filter uses A-2705
Set Filter uses A-2707-S

H 1 : 367.5 (mm)
H 2 : 355.5 (mm)
OD 1 : 207 (mm)
OD 2 : 208 (mm)
ID 1 : 123 (mm)

CONT : 9
VOL : 0.173

A-4212-S Air Filter Set Soft PU end cap Element

KUBOTA 3P300-11220+3P300-11230



Primary Filter uses A-4210
Secondary Filter uses A-4211

H 1 : 293.8 (mm)
H 2 : 281 (mm)
OD 1 : 207 (mm)
OD 2 : 207 (mm)
ID 1 : 106.5 (mm)

CONT : 4
VOL : 0.074

A-44150-S Air Filter Set Metal End Cap Element

CATERPILLAR 1P-7716+1P-7360



Primary Filter uses A-44150
Secondary Filter uses A-5502

H 1 : 343 (mm)
H 2 : 330 (mm)
OD 1 : 290.5 (mm)
OD 2 : 290.5 (mm)
ID 1 : 203.5 (mm)

CONT : 1
VOL : 0.035

Sakura Filter

Technical Specification

A-44180 Air Filter Primary Rigid PU end cap Element
CATERPILLAR 4M-8047



Secondary Filter uses A-5508
Set Filter uses A-44180-S
H 1 : 318 (mm)
H 2 : 306 (mm)
OD 1 : 234 (mm)
OD 2 : 234 (mm)
ID 1 : 122.5 (mm)

CONT : 4
VOL : 0.085

Note : IS A RIGID PU VERSION OF A-5507,A-4406

A-44250 Air Filter Foam Element
CATERPILLAR 8N2555



H 1 : 260 (mm)
OD 1 : 522 (mm)
OD 2 : 522 (mm)
ID 1 : 492 (mm)
ID 2 : 492 (mm)

CONT : 9
VOL : 0.083

A-5106 Air Filter Secondary Soft PU end cap Element
VOLVO 2908238
MASSEY-FERGUSON 3901478M1
J.C.BAMFORD 580-12021

Primary Filter uses A-5105
Set Filter uses A-5107-S
H 1 : 386 (mm)
H 2 : 380 (mm)
OD 1 : 104 (mm)
OD 2 : 107 (mm)
ID 1 : 93 (mm)

CONT : 25
VOL : 0.178

A-44180-S Air Filter Set Metal End Cap Element
CATERPILLAR 4M-8047+2S-1285



Primary Filter uses A-44180
Secondary Filter uses A-5508
H 1 : 318 (mm)
H 2 : 306 (mm)
OD 1 : 234 (mm)
OD 2 : 234 (mm)
ID 1 : 122.5 (mm)

CONT : 4
VOL : 0.094

A-44370 Air Filter Secondary Soft PU+Plastic Element
CATERPILLAR 447-0761



Primary Filter uses A-44380
Set Filter uses A-44380-S
H 1 : 392 (mm)
H 2 : 352 (mm)
OD 1 : 114.5 (mm)
OD 2 : 114.5 (mm)
ID 1 : 94 (mm)

CONT : 9
VOL : 0.081

A-5148 Air Filter Secondary Soft PU end cap Element
CATERPILLAR 233-5184
MANITOU 563415



Primary Filter uses A-5147
Set Filter uses A-5149-S
H 1 : 333.5 (mm)
H 2 : 333.5 (mm)
OD 1 : 87 (mm)
OD 2 : 86.5 (mm)
ID 1 : 72.5 (mm)

CONT : 25
VOL : 0.104

A-44220 Air Filter Primary Soft PU end cap Element
CATERPILLAR 1236855



Secondary Filter uses A-44230
Set Filter uses A-44240-S
H 1 : 395 (mm)
H 2 : 382 (mm)
OD 1 : 362 (mm)
OD 2 : 362 (mm)
ID 1 : 229 (mm)

CONT : 1
VOL : 0.058

A-44380 Air Filter Primary Soft PU end cap Element
CATERPILLAR 457-8206



Secondary Filter uses A-44370
Set Filter uses A-44380-S
H 1 : 416 (mm)
H 2 : 380 (mm)
OD 1 : 210 (mm)
OD 2 : 210 (mm)
ID 1 : 118 (mm)

CONT : 4
VOL : 0.110

A-5408 Air Filter Secondary Metal End Cap Element
ISUZU 1-14215034-0
ISUZU 1-14215036-0
NISSAN 16546-96014



Primary Filter uses A-6113
Set Filter uses A-5653-S
H 1 : 406 (mm)
OD 1 : 192.3 (mm)
OD 2 : 162.5 (mm)
ID 1 : 134.2 (mm)
ID 2 : 17 (mm)

CONT : 9
VOL : 0.167

Note : Is a Secondary Air filter for A-6113,A-54490

A-44230 Air Filter Secondary Soft PU end cap Element
CATERPILLAR 1236856



Primary Filter uses A-44220
Set Filter uses A-44240-S
H 1 : 386 (mm)
OD 1 : 229 (mm)
OD 2 : 220 (mm)
ID 1 : 175 (mm)

CONT : 4
VOL : 0.107

A-44380-S Air Filter Set Soft PU end cap Element
CATERPILLAR 457-8206+447-0761



Primary Filter uses A-44380
Secondary Filter uses A-44370
H 1 : 418 (mm)
H 2 : 380 (mm)
OD 1 : 210 (mm)
OD 2 : 210 (mm)
ID 1 : 94 (mm)

CONT : 4
VOL : 0.110

A-5417 Air Filter Secondary Metal End Cap Element
NISSAN 16546-90204
INTERNATIONAL HARVESTER 702753 C1



Primary Filter uses A-5425
Set Filter uses A-5425-S
H 1 : 393.7 (mm)
H 2 : 381 (mm)
OD 1 : 194 (mm)
OD 2 : 194 (mm)
ID 1 : 153 (mm)
ID 2 : 22.7 (mm)

CONT : 9
VOL : 0.169

A-44240-S Air Filter Set Soft PU end cap Element
CATERPILLAR 1236855+1236856



Primary Filter uses A-44220
Secondary Filter uses A-44230
H 1 : 395 (mm)
H 2 : 382 (mm)
OD 1 : 362 (mm)
OD 2 : 362 (mm)
ID 1 : 228 (mm)

CONT : 1
VOL : 0.060

A-5105 Air Filter Primary Soft PU end cap Element
BOMAG 05821147
VOLVO 2908237
MASSEY-FERGUSON 3901477M1
J.C.BAMFORD 580-12020

Secondary Filter uses A-5106
Set Filter uses A-5107-S
H 1 : 390 (mm)
H 2 : 367 (mm)
OD 1 : 194 (mm)
OD 2 : 194 (mm)
ID 1 : 113.5 (mm)

CONT : 4
VOL : 0.074

A-5424 Air Filter Metal End Cap Element
INTERNATIONAL HARVESTER 391852 R91
CATERPILLAR 3I-0288



H 1 : 273.4 (mm)
H 2 : 267 (mm)
OD 1 : 89 (mm)
OD 2 : 89 (mm)
ID 1 : 52.5 (mm)

CONT : 25
VOL : 0.083

Sakura Filter

Technical Specification

A-5425 Air Filter Primary Metal End Cap Element



HINO 17801-2020
HINO 17801-2270
HINO 17801-2290

Secondary Filter uses A-5417
Set Filter uses A-5425-S
H 1 : 418.7 (mm)
H 2 : 406 (mm)
OD 1 : 307 (mm)
OD 2 : 307 (mm)
ID 1 : 196 (mm)
ID 2 : 22.7 (mm)

CONT : 1
VOL : 0.050

31

A-5505 Air Filter Metal End Cap Element



CATERPILLAR 4L-9852

H 1 : 311.4 (mm)
H 2 : 305 (mm)
OD 1 : 264.5 (mm)
OD 2 : 264.5 (mm)
ID 1 : 153 (mm)

CONT : 1
VOL : 0.025

36

A-5508 Air Filter Secondary Metal End Cap Element



CATERPILLAR 2S-1285
CATERPILLAR 4M-8048

Primary Filter uses A-5507
Set Filter uses A-5507-S
H 1 : 339.5 (mm)
H 2 : 307 (mm)
OD 1 : 189 (mm)
OD 2 : 121.5 (mm)
ID 1 : 91.5 (mm)

CONT : 9
VOL : 0.140

41

A-5434 Air Filter Metal End Cap Element



KOMATSU 381-935694-1
INTERNATIONAL HARVESTER
935694 C1

H 1 : 419.2 (mm)
H 2 : 406.5 (mm)
OD 1 : 264.5 (mm)
OD 2 : 264.5 (mm)
ID 1 : 153 (mm)
ID 2 : 17 (mm)

CONT : 1
VOL : 0.036

32

A-5506 Air Filter Metal End Cap Element



CATERPILLAR 4L-9853

H 1 : 311 (mm)
H 2 : 305 (mm)
OD 1 : 352 (mm)
OD 2 : 352 (mm)
ID 1 : 241 (mm)

CONT : 1
VOL : 0.049

37

A-5509 Air Filter Primary Metal End Cap Element



CATERPILLAR 2P-5080(P)
CATERPILLAR 4M-9334
CATERPILLAR 7W-5317

Secondary Filter uses A-5510
Set Filter uses A-5509-S
H 1 : 342.7 (mm)
H 2 : 330 (mm)
OD 1 : 281 (mm)
OD 2 : 281 (mm)
ID 1 : 171 (mm)

CONT : 1
VOL : 0.031

Note : Metal version, PU version uses A-44130

42

A-5501 Air Filter Primary Metal End Cap Element



CATERPILLAR 1P-7716
CATERPILLAR 7W-5495
CATERPILLAR 8N-5495

Secondary Filter uses A-5502
Set Filter uses A-5501-S
H 1 : 342.7 (mm)
H 2 : 330 (mm)
OD 1 : 292 (mm)
OD 2 : 292 (mm)
ID 1 : 205.5 (mm)

CONT : 1
VOL : 0.033

Note : IS A metal VERSION OF A-44150

33

A-5507 Air Filter Primary Metal End Cap Element



CATERPILLAR 4M-8047
CATERPILLAR 7W-5389
CATERPILLAR 8N-5389

Secondary Filter uses A-5508
Set Filter uses A-5507-S
H 1 : 317.7 (mm)
H 2 : 305 (mm)
OD 1 : 234 (mm)
OD 2 : 234 (mm)
ID 1 : 123 (mm)

CONT : 4
VOL : 0.086

Note : Metal version, PU version uses A-44180

38

A-5510 Air Filter Secondary Metal End Cap Element



CATERPILLAR 1S1286
CATERPILLAR 2P-5080(S)
CATERPILLAR 2S-1286

Primary Filter uses A-5509
Set Filter uses A-5509-S
H 1 : 364 (mm)
H 2 : 332 (mm)
OD 1 : 230 (mm)
OD 2 : 159.5 (mm)
ID 1 : 115.8 (mm)

CONT : 4
VOL : 0.094

Note : Is a Secondary Air filter for A-5509,A-44130

43

A-5502 Air Filter Secondary Metal End Cap Element



CATERPILLAR 1P-7360

Primary Filter uses A-5501
Set Filter uses A-5501-S
H 1 : 340 (mm)
OD 1 : 259 (mm)
OD 2 : 194.5 (mm)
ID 1 : 150 (mm)

CONT : 1
VOL : 0.026

34

A-5507-S Air Filter Set Metal End Cap Element



CATERPILLAR 4M-8047+4M-8048
CATERPILLAR 7W-5389+2S-1285

Primary Filter uses A-5507
Secondary Filter uses A-5508
H 1 : 317.75 (mm)
H 2 : 305 (mm)
OD 1 : 234 (mm)
OD 2 : 234 (mm)
ID 1 : 123 (mm)

CONT : 4
VOL : 0.093

39

A-5511 Air Filter Primary Metal End Cap Element



CATERPILLAR 4M-9378

Secondary Filter uses A-5512
Set Filter uses A-5511-S
H 1 : 266.7 (mm)
H 2 : 254 (mm)
OD 1 : 212.5 (mm)
OD 2 : 212.5 (mm)
ID 1 : 102.5 (mm)

CONT : 4
VOL : 0.061

44

A-5504 Air Filter Metal End Cap Element



CATERPILLAR 4L-9851

H 1 : 209.4 (mm)
H 2 : 203 (mm)
OD 1 : 264.5 (mm)
OD 2 : 264.5 (mm)
ID 1 : 153 (mm)

CONT : 1
VOL : 0.017

35

A-55071-S Air Filter Set Metal End Cap Element



CATERPILLAR 7W-5389+8N-4901

Primary Filter uses A-5507
Secondary Filter uses A-5530
H 1 : 317.7 (mm)
H 2 : 305 (mm)
OD 1 : 234 (mm)
OD 2 : 234 (mm)
ID 1 : 123 (mm)

CONT : 4
VOL : 0.089

40

A-5511-S Air Filter Set Metal End Cap Element



CATERPILLAR 4M-9378+4M-9379

Primary Filter uses A-5511
Secondary Filter uses A-5512
H 1 : 266.7 (mm)
H 2 : 254 (mm)
OD 1 : 212.5 (mm)
OD 2 : 212.5 (mm)
ID 1 : 102.5 (mm)

CONT : 4
VOL : 0.067

45

Sakura Filter

Technical Specification

A-5512 Air Filter Secondary Metal End Cap Element

CATERPILLAR 2S-1284
CATERPILLAR 4M-9379



Primary Filter uses A-5511
Set Filter uses A-5511-S
H 1 : 288 (mm)
H 2 : 256 (mm)
OD 1 : 170 (mm)
OD 2 : 96 (mm)
ID 1 : 65.5 (mm)

CONT : 12
VOL : 0.135

46

A-5515-S Air Filter Set Metal End Cap Element

CATERPILLAR 4S-8337+4S-8340



Primary Filter uses A-5515
Secondary Filter uses A-5528
H 1 : 369.25 (mm)
H 2 : 356.5 (mm)
OD 1 : 324 (mm)
OD 2 : 365 (mm)
ID 1 : 212 (mm)
ID 2 : 23.7 (mm)

CONT : 1
VOL : 0.058

51

A-5521-S Air Filter Set Metal End Cap Element

CATERPILLAR 1P-8483+1P-8482
CATERPILLAR 7W-5313+1P-8482



Primary Filter uses A-5521
Secondary Filter uses A-5529
H 1 : 393.7 (mm)
H 2 : 381 (mm)
OD 1 : 317.5 (mm)
OD 2 : 317.5 (mm)
ID 1 : 178 (mm)

CONT : 1
VOL : 0.050

56

A-5513 Air Filter Metal framed Element

CATERPILLAR 4N-0015



H 1 : 132 (mm)
Length 1 : 381 (mm)
Width 1 : 378.5 (mm)

CONT : 1
VOL : 0.020

47

A-5517 Air Filter Metal End Cap Element

CATERPILLAR 4L-4719
CATERPILLAR 5L-1203
GENERAL MOTORS 6423135



H 1 : 463.3 (mm)
H 2 : 457 (mm)
OD 1 : 352 (mm)
OD 2 : 352 (mm)
ID 1 : 241 (mm)

CONT : 1
VOL : 0.070

52

A-5522 Air Filter Secondary Metal End Cap Element

CATERPILLAR 1W7365
CATERPILLAR 1W7919
CATERPILLAR 2P8863



Primary Filter uses A-5509
Set Filter uses A-5522-S
H 1 : 331.6 (mm)
H 2 : 330 (mm)
OD 1 : 230.5 (mm)
OD 2 : 159.5 (mm)
ID 1 : 117 (mm)

CONT : 1
VOL : 0.021

57

A-5514 Air Filter Primary Metal End Cap Element

CATERPILLAR 4S-8833



Secondary Filter uses A-5527
Set Filter uses A-5514-S
H 1 : 249.25 (mm)
H 2 : 236.5 (mm)
OD 1 : 324 (mm)
OD 2 : 365 (mm)
ID 1 : 212 (mm)
ID 2 : 23.7 (mm)

CONT : 1
VOL : 0.042

48

A-5518 Air Filter Metal framed Element

CATERPILLAR 6L-4714

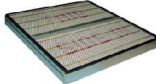

H 1 : 65 (mm)
Length 1 : 610 (mm)
Width 1 : 610 (mm)

CONT : 1
VOL : 0.031

53

A-5522-S Air Filter Set Metal End Cap Element

CATERPILLAR 4M-9334+9S-9972



Primary Filter uses A-5509
Secondary Filter uses A-5522
H 1 : 342.7 (mm)
H 2 : 330 (mm)
OD 1 : 282 (mm)
OD 2 : 282 (mm)
ID 1 : 171 (mm)

CONT : 1
VOL : 0.036

58

A-5514-S Air Filter Set Metal End Cap Element

CATERPILLAR 4S8833+4S8834



Primary Filter uses A-5514
Secondary Filter uses A-5527
Set Filter uses A-5514-S
H 1 : 249.25 (mm)
H 2 : 236.5 (mm)
OD 1 : 324 (mm)
OD 2 : 365 (mm)
ID 1 : 212 (mm)

CONT : 1
VOL : 0.040

49

A-5520 Air Filter Secondary Metal End Cap Element

CATERPILLAR 2S-1287
CATERPILLAR 7M-9046



Primary Filter uses A-5543
Set Filter uses A-5544
H 1 : 442 (mm)
H 2 : 410 (mm)
OD 1 : 230.5 (mm)
OD 2 : 159.5 (mm)
ID 1 : 115.8 (mm)

CONT : 1
VOL : 0.029

54

A-5525 Air Filter Secondary Metal End Cap Element

CATERPILLAR 4N-0313



Primary Filter uses A-5542
Set Filter uses A-5542-S
H 1 : 266.7 (mm)
H 2 : 254 (mm)
OD 1 : 85.5 (mm)
OD 2 : 85.5 (mm)
ID 1 : 57.5 (mm)
ID 2 : 17 (mm)

CONT : 25
VOL : 0.078

59

A-5515 Air Filter Primary Metal End Cap Element

CATERPILLAR 4S-8337



Secondary Filter uses A-5528
Set Filter uses A-5515-S
H 1 : 369.25 (mm)
H 2 : 356.5 (mm)
OD 1 : 324 (mm)
OD 2 : 365 (mm)
ID 1 : 212 (mm)
ID 2 : 23.7 (mm)

CONT : 1
VOL : 0.060

50

A-5521 Air Filter Primary Metal End Cap Element

CATERPILLAR 1P-8483
CATERPILLAR 7W-5313
CATERPILLAR 8N-5313



Secondary Filter uses A-5552
Set Filter uses A-5572-S
H 1 : 393.7 (mm)
H 2 : 381 (mm)
OD 1 : 317.5 (mm)
OD 2 : 317.5 (mm)
ID 1 : 232 (mm)

CONT : 1
VOL : 0.045

Note : Is a Primary Air Filter for A-5552,A-5529

55

A-5526 Air Filter Secondary Metal End Cap Element

CATERPILLAR 3S-4745



Primary Filter uses A-5557
Set Filter uses A-5557-S
H 1 : 388 (mm)
H 2 : 388 (mm)
OD 1 : 305 (mm)
OD 2 : 221 (mm)
ID 1 : 175 (mm)

CONT : 1
VOL : 0.045

60

Sakura Filter

Technical Specification

A-5528 Air Filter Secondary Metal End Cap Element
CATERPILLAR 4S-8340



Primary Filter uses A-5515
Set Filter uses A-5515-S
H 1 : 340 (mm)
H 2 : 340 (mm)
OD 1 : 259 (mm)
OD 2 : 194 (mm)
ID 1 : 150 (mm)

CONT : 1
VOL : 0.027

61

A-5531-S Air Filter Set Metal End Cap Element
CATERPILLAR 8N-6309+8N-2556



Primary Filter uses A-5531
Secondary Filter uses A-5533
H 1 : 262.7 (mm)
H 2 : 250 (mm)
OD 1 : 490 (mm)
OD 2 : 490 (mm)
ID 1 : 328.5 (mm)

CONT : 1
VOL : 0.070

66

A-5535 Air Filter Primary Soft PU end cap Element
CATERPILLAR 6I-0273



Secondary Filter uses A-5534
Set Filter uses A-5573-S
H 1 : 342 (mm)
H 2 : 330 (mm)
OD 1 : 292 (mm)
OD 2 : 292 (mm)
ID 1 : 183 (mm)

CONT : 1
VOL : 0.035

Note : With Metal Reinforcement uses A-5535M

71

A-5529 Air Filter Secondary Metal End Cap Element with 10 Bolt Holes
CATERPILLAR 1P-8482
CATERPILLAR 7N-1308



Primary Filter uses A-5532

H 1 : 389.6 (mm)
H 2 : 388 (mm)
OD 1 : 289 (mm)
OD 2 : 219.5 (mm)
ID 1 : 178 (mm)

CONT : 1
VOL : 0.038

Note : Is a Secondary Air filter for A-5532,A-5521

62

A-5532 Air Filter Primary Metal End Cap Element
CATERPILLAR 1W-2516
CATERPILLAR 7W-5216



Secondary Filter uses A-5529

H 1 : 482.75 (mm)
H 2 : 470 (mm)
OD 1 : 317.5 (mm)
OD 2 : 317.5 (mm)
ID 1 : 232 (mm)
ID 2 : 11.5 (mm)

CONT : 1
VOL : 0.060

67

A-5535M Air Filter Primary Soft PU+Metal Element
CATERPILLAR 6I-0273



Secondary Filter uses A-5534
Set Filter uses A-5573M-S
H 1 : 342 (mm)
H 2 : 330 (mm)
OD 1 : 292 (mm)
OD 2 : 292 (mm)
ID 1 : 183 (mm)

CONT : 1
VOL : 0.036

Note : Without metal reinforcement version uses A-5535

72

A-55291 Air Filter Secondary Metal End Cap Element with 10 Bolt Holes
CATERPILLAR 7N-1308



Primary Filter uses A-55211
Set Filter uses A-55211-S
H 1 : 384 (mm)
H 2 : 383 (mm)
OD 1 : 289 (mm)
OD 2 : 219.5 (mm)
ID 1 : 178 (mm)

CONT : 1
VOL : 0.038

63

A-5532-S Air Filter Set Metal End Cap Element
CATERPILLAR 1W-2516+1P-8482



Primary Filter uses A-5532
Secondary Filter uses A-5529
H 1 : 482.75 (mm)
H 2 : 470 (mm)
OD 1 : 317.5 (mm)
OD 2 : 317.5 (mm)
ID 1 : 232 (mm)
ID 2 : 11.5 (mm)

CONT : 1
VOL : 0.060

68

A-5536 Air Filter Secondary Soft PU end cap Element
CATERPILLAR 6I-1451



Primary Filter uses A-5537
Set Filter uses A-5537-S
H 1 : 148 (mm)
H 2 : 144 (mm)
OD 1 : 108 (mm)
OD 2 : 101 (mm)
ID 1 : 71 (mm)

CONT : 25
VOL : 0.062

73

A-5530 Air Filter Metal End Cap Element
CATERPILLAR 8N-4901



H 1 : 306.6 (mm)
H 2 : 305 (mm)
OD 1 : 189 (mm)
OD 2 : 121.5 (mm)
ID 1 : 91 (mm)

CONT : 9
VOL : 0.148

64

A-5533 Air Filter Secondary Metal End Cap Element
CATERPILLAR 8N-2556



Primary Filter uses A-5531
Set Filter uses A-5531-S
H 1 : 261.75 (mm)
H 2 : 249 (mm)
OD 1 : 397 (mm)
OD 2 : 325 (mm)
ID 1 : 257 (mm)

CONT : 1
VOL : 0.052

69

A-5537 Air Filter Primary Soft PU end cap Element
CATERPILLAR 6I-1450



Secondary Filter uses A-5536
Set Filter uses A-5537-S
H 1 : 167 (mm)
H 2 : 155 (mm)
OD 1 : 207 (mm)
OD 2 : 207 (mm)
ID 1 : 105.5 (mm)

CONT : 4
VOL : 0.040

74

A-5531 Air Filter Primary Metal End Cap Element
CATERPILLAR 8N-6309



Secondary Filter uses A-5533
Set Filter uses A-5531-S
H 1 : 262.6 (mm)
H 2 : 250 (mm)
OD 1 : 490 (mm)
OD 2 : 490 (mm)
ID 1 : 328.5 (mm)

CONT : 1
VOL : 0.074

65

A-5534 Air Filter Secondary Soft PU end cap Element
CATERPILLAR 6I-0274



Primary Filter uses A-5535
Set Filter uses A-5573-S
H 1 : 334 (mm)
OD 1 : 185.6 (mm)
OD 2 : 175.7 (mm)
ID 1 : 131 (mm)

CONT : 9
VOL : 0.145

70

A-5537-S Air Filter Set Soft PU end cap Element
CATERPILLAR 6I-1450+6I-1451



Primary Filter uses A-5537
Secondary Filter uses A-5536
H 1 : 167 (mm)
H 2 : 155 (mm)
OD 1 : 207 (mm)
OD 2 : 207 (mm)
ID 1 : 105.5 (mm)

CONT : 4
VOL : 0.041

75

Sakura Filter

Technical Specification

A-5540 Air Filter Secondary Soft PU end cap Element



YANMAR 119117-12570
CATERPILLAR 1318903
PERKINS 26510343
YANMAR Y119117-12570

Primary Filter uses A-5541
Set Filter uses A-5541-S
H 1 : 346 (mm)
H 2 : 340 (mm)
OD 1 : 92 (mm)
OD 2 : 86.5 (mm)
ID 1 : 72.5 (mm)

CONT : 25
VOL : 0.105

76

A-5542-S Air Filter Set Metal End Cap Element



CATERPILLAR 4N-0326+4N-0313

Primary Filter uses A-5542
Secondary Filter uses A-5525
H 1 : 305 (mm)
H 2 : 254 (mm)
OD 1 : 174 (mm)
OD 2 : 85 (mm)
ID 1 : 88 (mm)
ID 2 : 17 (mm)

CONT : 12
VOL : 0.144

81

A-5548 Air Filter Metal End Cap Element



CATERPILLAR 9G-1518

H 1 : 240.7 (mm)
H 2 : 228 (mm)
OD 1 : 174 (mm)
OD 2 : 174 (mm)
ID 1 : 107.7 (mm)
ID 2 : 17 (mm)

CONT : 18
VOL : 0.165

86

A-5541 Air Filter Primary Soft PU end cap Element



YANMAR 119117-12560
CATERPILLAR 131-8902
PERKINS 26510342
HITACHI 4486002

Secondary Filter uses A-5540
Set Filter uses A-5541-S
H 1 : 356 (mm)
H 2 : 347 (mm)
OD 1 : 163.5 (mm)
OD 2 : 163.5 (mm)
ID 1 : 91 (mm)

CONT : 9
VOL : 0.108

77

A-5543 Air Filter Primary Metal End Cap Element



CATERPILLAR 7M-9045
CATERPILLAR 7W-5316
CATERPILLAR 8N-5316

Secondary Filter uses A-5520
Set Filter uses A-5544
H 1 : 420.7 (mm)
H 2 : 408 (mm)
OD 1 : 282 (mm)
OD 2 : 282 (mm)
ID 1 : 171 (mm)

CONT : 1
VOL : 0.041

82

A-5549 Air Filter Primary Soft PU end cap Element



CATERPILLAR 128-2686
CATERPILLAR 6I-2501

Secondary Filter uses A-5550
Set Filter uses A-5549-S
H 1 : 339 (mm)
H 2 : 327 (mm)
OD 1 : 280 (mm)
OD 2 : 280 (mm)
ID 1 : 148 (mm)

CONT : 1
VOL : 0.032

87

A-5541M Air Filter Primary Soft PU+Metal Element



CATERPILLAR 131-8902

Secondary Filter uses A-5540
Set Filter uses A-5541M-S
H 1 : 356 (mm)
H 2 : 347 (mm)
OD 1 : 163.5 (mm)
OD 2 : 163.5 (mm)
ID 1 : 91 (mm)

CONT : 9
VOL : 0.108

78

A-5544-S Air Filter Set Metal End Cap Element



CATERPILLAR 7M-9045+9M-9046

Primary Filter uses A-5543
Secondary Filter uses A-5520
H 1 : 420.7 (mm)
H 2 : 408 (mm)
OD 1 : 282 (mm)
OD 2 : 282 (mm)
ID 1 : 171 (mm)

CONT : 1
VOL : 0.044

83

A-5549M Air Filter Primary Soft PU+Metal Element



CATERPILLAR 128-2686
CATERPILLAR 6I-2501

Secondary Filter uses A-5550
Set Filter uses A-5549M-S
H 1 : 339 (mm)
H 2 : 327 (mm)
OD 1 : 282 (mm)
OD 2 : 280 (mm)
ID 1 : 148 (mm)

CONT : 1
VOL : 0.032

88

A-5541M-S Air Filter Set Soft PU+Metal Element



CATERPILLAR 131-8902+131-8903

Primary Filter uses A-5541M
Secondary Filter uses A-5540
H 1 : 353 (mm)
H 2 : 344 (mm)
OD 1 : 163.5 (mm)
OD 2 : 163.5 (mm)
ID 1 : 91 (mm)

CONT : 9
VOL : 0.119

79

A-5546 Air Filter Metal End Cap Element



CATERPILLAR 2V-0036

H 1 : 241 (mm)
H 2 : 228.5 (mm)
OD 1 : 174 (mm)
OD 2 : 174 (mm)
ID 1 : 107.5 (mm)

CONT : 18
VOL : 0.165

84

A-5549M-S Air Filter Set Soft PU+Metal Element



CATERPILLAR 6I-2501+6I-2502

Primary Filter uses A-5549M
Secondary Filter uses A-5550
H 1 : 339 (mm)
H 2 : 327 (mm)
OD 1 : 282 (mm)
OD 2 : 282 (mm)
ID 1 : 148 (mm)

CONT : 1
VOL : 0.031

89

A-5542 Air Filter Primary Metal End Cap Element



CATERPILLAR 4N-0326

Secondary Filter uses A-5525
Set Filter uses A-5542-S
H 1 : 315.9 (mm)
H 2 : 305 (mm)
OD 1 : 174 (mm)
OD 2 : 174 (mm)
ID 1 : 89.4 (mm)
ID 2 : 17 (mm)

CONT : 12
VOL : 0.145

80

A-5547 Air Filter Metal End Cap Element



CATERPILLAR 7G-8116

H 1 : 190.5 (mm)
H 2 : 177.8 (mm)
OD 1 : 155 (mm)
OD 2 : 155 (mm)
ID 1 : 88 (mm)
ID 2 : 17 (mm)

CONT : 12
VOL : 0.078

85

A-5550 Air Filter Secondary Soft PU end cap Element



CATERPILLAR 6I-2502

Primary Filter uses A-5549
Set Filter uses A-5549-S
H 1 : 316 (mm)
OD 1 : 150 (mm)
OD 2 : 142 (mm)
ID 1 : 109 (mm)

CONT : 1
VOL : 0.009

Note : Set uses A-5549-S or A-5549M-S

90

Sakura Filter

Technical Specification

A-5551 Air Filter Metal End Cap Element
CATERPILLAR 4P-0710



H 1 : 364.2 (mm)
H 2 : 351.5 (mm)
OD 1 : 490 (mm)
OD 2 : 490 (mm)
ID 1 : 328.5 (mm)

CONT : 1
VOL : 0.104

91

A-5555-S Air Filter Set Soft PU end cap Element
CATERPILLAR 6I-2505+6I-2506



Primary Filter uses A-5555
Secondary Filter uses A-5556
H 1 : 393.5 (mm)
H 2 : 381.5 (mm)
OD 1 : 317.6 (mm)
OD 2 : 317.6 (mm)
ID 1 : 209 (mm)

CONT : 1
VOL : 0.050

96

A-5559 Air Filter Secondary Soft PU end cap Element
KOMATSU 424-01-H0P02
KOMATSU 600-185-5100S
KOMATSU 600-185-5120



Primary Filter uses A-5558
Set Filter uses A-5558-S
H 1 : 394 (mm)
OD 1 : 150 (mm)
OD 2 : 142.3 (mm)
ID 1 : 109 (mm)

CONT : 1
VOL : 0.012

101

A-5551-S Air Filter Set Metal End Cap Element
CATERPILLAR 4P-0710+4P-0711



Primary Filter uses A-5551
Secondary Filter uses A-5588
H 1 : 364 (mm)
H 2 : 351.5 (mm)
OD 1 : 490 (mm)
OD 2 : 490 (mm)
ID 1 : 257 (mm)

CONT : 1
VOL : 0.104

92

A-5556 Air Filter Secondary Soft PU end cap Element
CATERPILLAR 6I-2506



Primary Filter uses A-5555
Set Filter uses A-5555-S
H 1 : 385.5 (mm)
OD 1 : 211 (mm)
OD 2 : 212 (mm)
ID 1 : 156.5 (mm)

CONT : 9
VOL : 0.203

97

A-5560 Air Filter Secondary Soft PU end cap Element
CATERPILLAR 6I-2508



Primary Filter uses A-5561
Set Filter uses A-5562-S
H 1 : 297.6 (mm)
H 2 : 297.6 (mm)
OD 1 : 211 (mm)
OD 2 : 200 (mm)
ID 1 : 156.5 (mm)

CONT : 1
VOL : 0.016

102

A-5552 Air Filter Secondary Metal End Cap Element
CATERPILLAR 6N-6444



Primary Filter uses A-5521
Set Filter uses A-5572-S
H 1 : 305.6 (mm)
H 2 : 304 (mm)
OD 1 : 289 (mm)
OD 2 : 219.5 (mm)
ID 1 : 178 (mm)

CONT : 1
VOL : 0.030

93

A-5557 Air Filter Primary Metal End Cap Element
CATERPILLAR 5S-4282



Secondary Filter uses A-5526
Set Filter uses A-5557-S
H 1 : 410.7 (mm)
H 2 : 398 (mm)
OD 1 : 352 (mm)
OD 2 : 417 (mm)
ID 1 : 241 (mm)
ID 2 : 24 (mm)

CONT : 1
VOL : 0.086

98

A-5561 Air Filter Primary Soft PU end cap Element
CATERPILLAR 6I-2507



Secondary Filter uses A-5560
Set Filter uses A-5562-S
H 1 : 393.5 (mm)
H 2 : 381.5 (mm)
OD 1 : 317.6 (mm)
OD 2 : 317.6 (mm)
ID 1 : 209 (mm)

CONT : 1
VOL : 0.045

103

A-5553 Air Filter Metal End Cap Element
CATERPILLAR 7N-1225



H 1 : 241.7 (mm)
H 2 : 229 (mm)
OD 1 : 264.5 (mm)
OD 2 : 264.5 (mm)
ID 1 : 153 (mm)

CONT : 1
VOL : 0.020

94

A-5557-S Air Filter Set Metal End Cap Element
CATERPILLAR 5S-4282+3S-4745



Primary Filter uses A-5557
Secondary Filter uses A-5526
H 1 : 410.7 (mm)
H 2 : 398 (mm)
OD 1 : 352 (mm)
OD 2 : 417 (mm)
ID 1 : 241 (mm)
ID 2 : 24 (mm)

CONT : 1
VOL : 0.086

99

A-5562-S Air Filter Set Soft PU end cap Element
CATERPILLAR 6I-2507+6I-2508



Primary Filter uses A-5561
Secondary Filter uses A-5560
H 1 : 393.5 (mm)
H 2 : 381.5 (mm)
OD 1 : 317.6 (mm)
OD 2 : 317.6 (mm)
ID 1 : 209 (mm)

CONT : 1
VOL : 0.048

104

A-5555 Air Filter Primary Soft PU end cap Element
CATERPILLAR 6I-2505



Secondary Filter uses A-5556
Set Filter uses A-5555-S
H 1 : 393.5 (mm)
H 2 : 381.5 (mm)
OD 1 : 317.6 (mm)
OD 2 : 317.6 (mm)
ID 1 : 209 (mm)

CONT : 1
VOL : 0.045

95

A-5558 Air Filter Primary Soft PU end cap Element
KOMATSU 424-01-H0P03
KOMATSU 600-185-5100P
KOMATSU 600-185-5110



Secondary Filter uses A-5559
Set Filter uses A-5558-S
H 1 : 417 (mm)
H 2 : 405 (mm)
OD 1 : 280 (mm)
OD 2 : 280 (mm)
ID 1 : 148 (mm)

CONT : 1
VOL : 0.038

100

A-5563 Air Filter Secondary Soft PU end cap Element
CATERPILLAR 6I-2510



Primary Filter uses A-5564
Set Filter uses A-5565-S
H 1 : 385.5 (mm)
OD 1 : 211 (mm)
OD 2 : 200 (mm)
ID 1 : 156.5 (mm)

CONT : 1
VOL : 0.022

105

Sakura Filter

Technical Specification

A-5564 Air Filter Primary Soft PU end cap Element
CATERPILLAR 6I-2509



Secondary Filter uses A-5563
Set Filter uses A-5565-S
H 1 : 482 (mm)
H 2 : 470 (mm)
OD 1 : 317.6 (mm)
OD 2 : 317.6 (mm)
ID 1 : 209 (mm)

CONT : 1
VOL : 0.054

106

A-5569 Air Filter Secondary Soft PU end cap Element
VOLVO 11801160
CATERPILLAR 1467473
JOHN DEERE M131803
KOMATSU YM12905112530



Primary Filter uses A-8513
Set Filter uses A-5570-S
H 1 : 265 (mm)
H 2 : 259 (mm)
OD 1 : 61 (mm)
OD 2 : 59 (mm)
ID 1 : 45 (mm)

CONT : 25
VOL : 0.048

111

A-5578-S Air Filter Set Metal End Cap Element
CATERPILLAR 8N5504+7N9027



Primary Filter uses A-5577
Secondary Filter uses A-5576
H 1 : 148.7 (mm)
H 2 : 136 (mm)
OD 1 : 212.5 (mm)
OD 2 : 213.5 (mm)
ID 1 : 102.5 (mm)

CONT : 6
VOL : 0.064

116

A-5565-S Air Filter Set Soft PU end cap Element
CATERPILLAR 6I-2509+6I-2510



Primary Filter uses A-5564
Secondary Filter uses A-5563
H 1 : 482 (mm)
H 2 : 470 (mm)
OD 1 : 317.6 (mm)
OD 2 : 317.6 (mm)
ID 1 : 209 (mm)

CONT : 1
VOL : 0.057

107

A-5573-S Air Filter Set Soft PU end cap Element
CATERPILLAR 6I-0273+6I-0274



Primary Filter uses A-5535
Secondary Filter uses A-5534
H 1 : 342 (mm)
H 2 : 330 (mm)
OD 1 : 292 (mm)
OD 2 : 292 (mm)
ID 1 : 183 (mm)

CONT : 1
VOL : 0.034

112

A-5579-S Air Filter Set Metal End Cap Element
CATERPILLAR 7N-9028+7W-6754



Primary Filter uses A-5577
Secondary Filter uses A-5580
H 1 : 148.7 (mm)
H 2 : 136 (mm)
OD 1 : 212.5 (mm)
OD 2 : 213.5 (mm)
ID 1 : 102.5 (mm)

CONT : 9
VOL : 0.085

117

A-5566 Air Filter Primary Soft PU end cap Element
CATERPILLAR 6I-2499



Secondary Filter uses A-5567
Set Filter uses A-5568-S
H 1 : 315 (mm)
H 2 : 305 (mm)
OD 1 : 232 (mm)
OD 2 : 232 (mm)
ID 1 : 118 (mm)

CONT : 4
VOL : 0.088

108

A-5573M-S Air Filter Set Soft PU+Metal Element
CATERPILLAR 6I-0273+6I-0274



Primary Filter uses A-5535M
Secondary Filter uses A-5534
H 1 : 342 (mm)
H 2 : 330 (mm)
OD 1 : 292 (mm)
OD 2 : 292 (mm)
ID 1 : 183 (mm)

CONT : 1
VOL : 0.034

Note : Set Filter [SOFT PU Only Uses A-5573-S]

113

A-5580 Air Filter Secondary Metal End Cap Element
CATERPILLAR 7W6754
CATERPILLAR 7W6754E



Primary Filter uses A-5577
Set Filter uses A-5579
H 1 : 131.5 (mm)
H 2 : 130 (mm)
OD 1 : 170 (mm)
OD 2 : 96 (mm)
ID 1 : 65 (mm)

CONT : 18
VOL : 0.096

118

A-5567 Air Filter Secondary Soft PU end cap Element
CATERPILLAR 6I-2500



Primary Filter uses A-5566
Set Filter uses A-5568-S
H 1 : 294 (mm)
OD 1 : 120 (mm)
OD 2 : 114 (mm)
ID 1 : 82 (mm)

CONT : 20
VOL : 0.120

109

A-5576 Air Filter Secondary Metal End Cap Element
CATERPILLAR 4W-6691
CATERPILLAR 7N-9027



Primary Filter uses A-5577
Set Filter uses A-5578-S
H 1 : 162 (mm)
H 2 : 130 (mm)
OD 1 : 170 (mm)
OD 2 : 170 (mm)
ID 1 : 65.5 (mm)

CONT : 18
VOL : 0.118

114

A-5581 Air Filter Primary Soft PU end cap Element
CATERPILLAR 102-9388



Secondary Filter uses A-5582
Set Filter uses A-5583-S
H 1 : 189.5 (mm)
H 2 : 177 (mm)
OD 1 : 207 (mm)
OD 2 : 207 (mm)
ID 1 : 105.5 (mm)

CONT : 9
VOL : 0.097

119

A-5568-S Air Filter Set Soft PU end cap Element
CATERPILLAR 6I-2499+6I-2500



Primary Filter uses A-5566
Secondary Filter uses A-5567
H 1 : 315 (mm)
H 2 : 305 (mm)
OD 1 : 232 (mm)
OD 2 : 232 (mm)
ID 1 : 118 (mm)

CONT : 4
VOL : 0.092

110

A-5577 Air Filter Primary Metal End Cap Element
CATERPILLAR 7N-9028
CATERPILLAR 8N-5504



Secondary Filter uses A-5576
Set Filter uses A-5578-S
H 1 : 148.7 (mm)
H 2 : 136 (mm)
OD 1 : 213.5 (mm)
OD 2 : 213.5 (mm)
ID 1 : 102.5 (mm)

CONT : 12
VOL : 0.108

115

A-5582 Air Filter Secondary Soft PU end cap Element
CATERPILLAR 102-9387



Set Filter uses A-5583-S
H 1 : 171 (mm)
H 2 : 165 (mm)
OD 1 : 108 (mm)
OD 2 : 101 (mm)
ID 1 : 68.5 (mm)

CONT : 25
VOL : 0.073

120

Sakura Filter

Technical Specification

A-5583-S Air Filter Set Soft PU end cap Element
CATERPILLAR 102-9388+102-9387



Primary Filter uses A-5581
Secondary Filter uses A-5582
H 1 : 189.5 (mm)
H 2 : 177 (mm)
OD 1 : 207 (mm)
OD 2 : 207 (mm)
ID 1 : 105.5 (mm)

CONT : 9
VOL : 0.097

A-5594 Air Filter Secondary Soft PU end cap Element
CATERPILLAR 1063973



Primary Filter uses A-5593
Set Filter uses A-5595-S
H 1 : 451 (mm)
OD 1 : 229 (mm)
OD 2 : 219 (mm)
ID 1 : 175 (mm)

CONT : 1
VOL : 0.027

A-55980 Air Filter Secondary Soft PU end cap Element
COOPERS AES2761
COOPERSFIAAM FL19215



Primary Filter uses A-5597
Set Filter uses A-5597-S
H 1 : 262 (mm)
H 2 : 256 (mm)
OD 1 : 61 (mm)
OD 2 : 60 (mm)
ID 1 : 45 (mm)

CONT : 25
VOL : 0.039

A-5584 Air Filter Soft PU framed Element
CATERPILLAR 112-7448



H 1 : 48 (mm)
Length 1 : 287 (mm)
Width 1 : 226 (mm)

CONT : 20
VOL : 0.078

A-5595-S Air Filter Set Soft PU end cap Element
CATERPILLAR 106-3969+106-3973



Primary Filter uses A-5593
Secondary Filter uses A-5594
H 1 : 460 (mm)
H 2 : 447 (mm)
OD 1 : 362 (mm)
OD 2 : 362 (mm)
ID 1 : 229 (mm)

CONT : 1
VOL : 0.069

A-5627 Air Filter Primary Metal End Cap Element
KOBELCO 2451-U311-3
DAEWOO 2474-6006A
DAEWOO 2474-6006B



Secondary Filter uses A-6008
Set Filter uses A-5663-S
H 1 : 393.7 (mm)
H 2 : 381 (mm)
OD 1 : 235 (mm)
OD 2 : 187 (mm)
ID 1 : 120 (mm)
ID 2 : 17 (mm)

CONT : 1
VOL : 0.027

A-5588 Air Filter Primary Element
CATERPILLAR 4P-0711



Secondary Filter uses A-5588
Set Filter uses A-5551-S
H 1 : 361.7 (mm)
H 2 : 349 (mm)
OD 1 : 397 (mm)
OD 2 : 325 (mm)
ID 1 : 257 (mm)

CONT : 1
VOL : 0.065

Note : Is a Secondary Air filter for A-5551,A-4403

A-5596 Air Filter Soft PU end cap Element
CATERPILLAR 9L-2169



H 1 : 35 (mm)
H 2 : 32 (mm)
OD 1 : 77 (mm)
OD 2 : 77 (mm)
ID 1 : 39 (mm)
ID 2 : 39 (mm)

CONT : 100
VOL : 0.031

A-5629 Air Filter Primary Metal End Cap Element
ISUZU 1-14125082-0
ISUZU 1-14215082-0
CATERPILLAR 3I-0202



Secondary Filter uses A-5630
Set Filter uses A-5629-S
H 1 : 622 (mm)
H 2 : 609.5 (mm)
OD 1 : 307 (mm)
OD 2 : 307 (mm)
ID 1 : 196 (mm)
ID 2 : 22.7 (mm)

CONT : 1
VOL : 0.072

A-5590 Air Filter Secondary Metal End Cap Element
CATERPILLAR 101-1460
CATERPILLAR 4N-0313



Primary Filter uses AS-5591
Set Filter uses AS-5592-S
H 1 : 247.3 (mm)
H 2 : 241 (mm)
OD 1 : 85.5 (mm)
OD 2 : 85.5 (mm)
ID 1 : 57.5 (mm)
ID 2 : 17 (mm)

CONT : 25
VOL : 0.062

A-5597 Air Filter Primary Soft PU end cap Element
PERKINS 135326205
CATERPILLAR 246-5011



Secondary Filter uses A-55980
Set Filter uses A-5597-S
H 1 : 273 (mm)
H 2 : 257 (mm)
OD 1 : 105 (mm)
OD 2 : 105 (mm)
ID 1 : 62 (mm)

CONT : 16
VOL : 0.072

A-5629-S Air Filter Set Metal End Cap Element
HITACHI 4240294+4240295
KOMATSU
561-02-12330+561-02-12320



Primary Filter uses A-5629
Secondary Filter uses A-5630
H 1 : 622 (mm)
H 2 : 609.5 (mm)
OD 1 : 307 (mm)
OD 2 : 307 (mm)
ID 1 : 196 (mm)
ID 2 : 22.7 (mm)

CONT : 1
VOL : 0.072

A-5593 Air Filter Primary Soft PU end cap Element
CATERPILLAR 1063969



Secondary Filter uses A-5594
Set Filter uses A-5595-S
H 1 : 460 (mm)
H 2 : 447 (mm)
OD 1 : 362 (mm)
OD 2 : 362 (mm)
ID 1 : 229 (mm)

CONT : 1
VOL : 0.067

A-5597-S Air Filter Set Soft PU end cap Element
CATERPILLAR 246-5011SET
COOPERS AEM2760+AES2761



Primary Filter uses A-5597
Secondary Filter uses A-55980
H 1 : 273 (mm)
H 2 : 257 (mm)
OD 1 : 105 (mm)
OD 2 : 105 (mm)
ID 1 : 62 (mm)

CONT : 16
VOL : 0.073

A-5630 Air Filter Secondary Metal End Cap Element
ISUZU 1-14215081-0
CATERPILLAR 3I-0203
HITACHI 4240295



Primary Filter uses A-5629
Set Filter uses A-5629-S
H 1 : 596.7 (mm)
H 2 : 584 (mm)
OD 1 : 185 (mm)
OD 2 : 185 (mm)
ID 1 : 157.5 (mm)
ID 2 : 17 (mm)

CONT : 1
VOL : 0.024

Sakura Filter

Technical Specification

A-5663-S Air Filter Set Metal End Cap Element
KOMATSU 600-181-6050



Primary Filter uses A-5627
Secondary Filter uses A-6008
H 1 : 380 (mm)
H 2 : 330 (mm)
OD 1 : 235 (mm)
OD 2 : 187 (mm)
ID 1 : 120 (mm)
ID 2 : 17 (mm)

CONT : 1
VOL : 0.030

A-5675-S Air Filter Set Soft PU end cap Element
KOMATSU 600-185-2500



Primary Filter uses A-5673
Secondary Filter uses A-5674
H 1 : 392 (mm)
H 2 : 384 (mm)
OD 1 : 186 (mm)
OD 2 : 186 (mm)
ID 1 : 106 (mm)

CONT : 1
VOL : 0.018

A-6008 Air Filter Secondary Metal End Cap Element
ISUZU 1-14215047-0
ISUZU 1-1425-046-1
NISSAN 16546-96010



Primary Filter uses A-5627
Set Filter uses A-5663-S
H 1 : 330 (mm)
OD 1 : 146 (mm)
OD 2 : 116.5 (mm)
ID 1 : 88 (mm)
ID 2 : 17 (mm)

CONT : 9
VOL : 0.083

A-5673 Air Filter Primary Soft PU end cap Element
YANMAR 172660-13840
CATERPILLAR 206-5234
KOMATSU 600-185-2510



Secondary Filter uses A-5674
Set Filter uses A-5675-S
H 1 : 392 (mm)
H 2 : 384 (mm)
OD 1 : 186 (mm)
OD 2 : 186 (mm)
ID 1 : 106 (mm)

CONT : 9
VOL : 0.154

A-5708 Air Filter Metal End Cap Element
CUMMINS 158877



H 1 : 266.75 (mm)
H 2 : 254 (mm)
OD 1 : 234 (mm)
OD 2 : 234 (mm)
ID 1 : 123 (mm)
ID 2 : 14 (mm)

CONT : 4
VOL : 0.072

A-6009 Air Filter Secondary Metal End Cap Element
NISSAN 16546-96004
KOBELCO 2451U180-3B
KOBELCO 2451U206-3



Primary Filter uses AS-1024
Set Filter uses AS-1024-S
H 1 : 397 (mm)
H 2 : 397 (mm)
OD 1 : 146.2 (mm)
OD 2 : 166.5 (mm)
ID 1 : 88 (mm)
ID 2 : 17 (mm)

CONT : 9
VOL : 0.100

A-56731 Air Filter Primary Soft PU end cap Element
MANITOU 775479



Secondary Filter uses A-56741
Set Filter uses A-56731-S
H 1 : 394.5 (mm)
H 2 : 385 (mm)
OD 1 : 186 (mm)
OD 2 : 184 (mm)
ID 1 : 105.5 (mm)

CONT : 1
VOL : 0.000

A-5715 Air Filter Secondary Metal End Cap Element
CATERPILLAR 1N-4864
CUMMINS 3013213
CATERPILLAR 3I-0215



Primary Filter uses A-5718
Set Filter uses A-5718-S
H 1 : 571.75 (mm)
H 2 : 559 (mm)
OD 1 : 260 (mm)
OD 2 : 260 (mm)
ID 1 : 231.5 (mm)
ID 2 : 23 (mm)

CONT : 1
VOL : 0.047

A-6113 Air Filter Primary Metal End Cap Element
FIAT 01901779
ISUZU 1-14215046-0
NISSAN 16546-96017



Secondary Filter uses A-5408
Set Filter uses A-5653-S
H 1 : 418.7 (mm)
H 2 : 406 (mm)
OD 1 : 282 (mm)
OD 2 : 282 (mm)
ID 1 : 171 (mm)
ID 2 : 17 (mm)

CONT : 1
VOL : 0.038

A-56731-S Air Filter Set Soft PU end cap Element
MANITOU 77549+775480



Primary Filter uses A-56731
Secondary Filter uses A-56741
H 1 : 395 (mm)
H 2 : 385 (mm)
OD 1 : 186 (mm)
OD 2 : 184 (mm)
ID 1 : 87 (mm)

CONT : 0
VOL : 0.000

A-6006 Air Filter Primary Metal End Cap Element
ISUZU 1-14214108-0
ISUZU 1-14214153-0
ISUZU 1-14215060-0
NISSAN 16546-Z9010
TOYOTA 17801-2560



Secondary Filter uses A-6007
Set Filter uses A-6118-S
H 1 : 342.7 (mm)
H 2 : 330 (mm)
OD 1 : 232 (mm)
OD 2 : 232 (mm)
ID 1 : 147 (mm)
ID 2 : 23 (mm)

CONT : 4
VOL : 0.093

Note : For Flame Retardant version use A-60400

A-6118-S Air Filter Set Metal End Cap Element
NISSAN 16546-Z9025
NISSAN 16546-Z9027
CATERPILLAR 7Y-0404+7Y-0403



Primary Filter uses A-6006
Secondary Filter uses A-6007
H 1 : 343 (mm)
H 2 : 330 (mm)
OD 1 : 232 (mm)
OD 2 : 232 (mm)
ID 1 : 147 (mm)
ID 2 : 23 (mm)

CONT : 1
VOL : 0.024

A-56741 Air Filter Secondary Soft PU end cap Element
MANITOU 775480



Primary Filter uses A-56731
Set Filter uses A-56731-S
H 1 : 382.5 (mm)
H 2 : 378 (mm)
OD 1 : 106 (mm)
OD 2 : 100 (mm)
ID 1 : 87 (mm)

CONT : 0
VOL : 0.000

A-6007 Air Filter Secondary Metal End Cap Element
ISUZU 1-14215061-0
ISUZU 1-14215078-0
ISUZU 1-14215078-1



Primary Filter uses A-6006
Set Filter uses A-6118-S
H 1 : 317.7 (mm)
H 2 : 305 (mm)
OD 1 : 145 (mm)
OD 2 : 145 (mm)
ID 1 : 116.5 (mm)
ID 2 : 23 (mm)

CONT : 9
VOL : 0.078

Note : ID=17 MM uses A-6031

A-6211 Air Filter Primary Metal End Cap Element
MERCEDES-BENZ 001 094 46 04
DEUTZ 2165044



Secondary Filter uses A-6212
Set Filter uses A-6211-S
H 1 : 352.7 (mm)
H 2 : 340 (mm)
OD 1 : 164 (mm)
OD 2 : 164 (mm)
ID 1 : 87 (mm)
ID 2 : 8.5 (mm)

CONT : 9
VOL : 0.105

Sakura Filter

Technical Specification

A-6702 Air Filter Metal End Cap Element

MASSEY-FERGUSON 1090118M91
CUMMINS 132102
CUMMINS 151688



H 1 : 355.5 (mm)
OD 1 : 352 (mm)
OD 2 : 352 (mm)
ID 1 : 241 (mm)
ID 2 : 13.5 (mm)

CONT : 1
VOL : 0.055

Note : with gaskets version uses A-8545

151

A-7003 Air Filter Primary Soft PU end cap Element

FIAT 1930587
PERKINS 26510337
FIAT 366-08109



Secondary Filter uses A-7004
Set Filter uses A-7003-S

H 1 : 327.8 (mm)
H 2 : 319 (mm)
OD 1 : 138 (mm)
OD 2 : 138 (mm)
ID 1 : 81 (mm)

CONT : 1
VOL : 0.008

156

A-76600 Air Filter Primary Soft PU end cap Element

CATERPILLAR 108-0671
JOHN DEERE AT175344



H 1 : 296 (mm)
H 2 : 284 (mm)
OD 1 : 207 (mm)
OD 2 : 207 (mm)
ID 1 : 105 (mm)

CONT : 4
VOL : 0.070

Note : Alternate parts A-4210

161

A-6703 Air Filter Primary Soft PU end cap Element

MERCEDES-BENZ 004 094 04 04
MASSEY-FERGUSON 3901475M1
BOBCAT 6910725
LIEBHERR 761 1451

Secondary Filter uses A-6705
Set Filter uses A-6706-S

H 1 : 375 (mm)
H 2 : 342 (mm)
OD 1 : 159 (mm)
OD 2 : 159 (mm)
ID 1 : 94 (mm)

CONT : 9
VOL : 0.118

152

A-7004 Air Filter Secondary Soft PU end cap Element

FIAT 1930588
PERKINS 26510338



Primary Filter uses A-7003
Set Filter uses A-7003-S

H 1 : 319 (mm)
H 2 : 312 (mm)
OD 1 : 84 (mm)
OD 2 : 79 (mm)
ID 1 : 63 (mm)

CONT : 25
VOL : 0.082

157

A-7902 Air Filter Secondary Metal End Cap Element

HITACHI 4331920
CATERPILLAR 9Y-7663



Primary Filter uses A-9217
Set Filter uses A-9217-S

H 1 : 563.35 (mm)
H 2 : 550.6 (mm)
OD 1 : 276 (mm)
OD 2 : 276 (mm)
ID 1 : 207.5 (mm)
ID 2 : 22.7 (mm)

CONT : 1
VOL : 0.048

162

A-6902 Air Filter Secondary Metal End Cap Element

CUMMINS 3013211
INGERSOLL RAND 35123520
CATERPILLAR 3I-0095



Primary Filter uses A-6903
Set Filter uses A-6903-S

H 1 : 571.7 (mm)
H 2 : 559 (mm)
OD 1 : 209.5 (mm)
OD 2 : 209.5 (mm)
ID 1 : 180.5 (mm)
ID 2 : 23 (mm)

CONT : 9
VOL : 0.265

153

A-76231 Air Filter Primary Soft PU end cap Element flame retardant media

CLARK 1241080
TOYOTA 17741-U3330-71
KOMATSU 3EC02A541E



H 1 : 356 (mm)
H 2 : 347 (mm)
OD 1 : 163.5 (mm)
OD 2 : 163.5 (mm)
ID 1 : 91 (mm)

CONT : 9
VOL : 0.116

Note : Flame Retardant version of A-5541

158

A-7912 Air Filter Primary Metal End Cap Element

HITACHI 408065
CASE 45252
STEIGER 45252
INGERSOLL RAND 506163930



Secondary Filter uses A-7915
Set Filter uses A-7912-S

H 1 : 469.75 (mm)
H 2 : 457 (mm)
OD 1 : 352 (mm)
OD 2 : 352 (mm)
ID 1 : 241 (mm)
ID 2 : 23 (mm)

CONT : 1
VOL : 0.071

163

A-6903 Air Filter Primary Metal End Cap Element

CUMMINS 3013210
INGERSOLL RAND 35123512
CATERPILLAR 3I-0802



Secondary Filter uses A-6902
Set Filter uses A-6903-S

H 1 : 622.7 (mm)
H 2 : 610 (mm)
OD 1 : 324 (mm)
OD 2 : 324 (mm)
ID 1 : 212 (mm)
ID 2 : 23 (mm)

CONT : 1
VOL : 0.076

154

A-7626 Air Filter Secondary Soft PU end cap Element

CATERPILLAR 246-5010
JOHN DEERE AH174196
JOHN DEERE AH174196A



Primary Filter uses A-8686
Set Filter uses A-7627-S

H 1 : 624 (mm)
OD 1 : 229 (mm)
OD 2 : 219 (mm)
ID 1 : 175 (mm)

CONT : 1
VOL : 0.038

159

A-7912-S Air Filter Set Metal End Cap Element

VOLVO 4881174 + 4881175
EUCLID 9035992+9035993



Primary Filter uses A-7912
Secondary Filter uses A-7915

H 1 : 469.75 (mm)
H 2 : 457 (mm)
OD 1 : 352 (mm)
OD 2 : 352 (mm)
ID 1 : 241 (mm)
ID 2 : 23 (mm)

CONT : 1
VOL : 0.071

164

A-6903-S Air Filter Set Metal End Cap Element

INGERSOLL RAND
3013211+3013210



Primary Filter uses A-6903
Secondary Filter uses A-6902

H 1 : 622.7 (mm)
H 2 : 610 (mm)
OD 1 : 324 (mm)
OD 2 : 324 (mm)
ID 1 : 212 (mm)
ID 2 : 23 (mm)

CONT : 1
VOL : 0.073

155

A-7627-S Air Filter Set Soft PU end cap Element

NEW HOLLAND (CNH) 84432503 +
84432504



Primary Filter uses A-8686
Secondary Filter uses A-7626

H 1 : 633 (mm)
H 2 : 620 (mm)
OD 1 : 362 (mm)
OD 2 : 362 (mm)
ID 1 : 229 (mm)

CONT : 1
VOL : 0.099

160

A-7913 Air Filter Secondary Metal End Cap Element

NISSAN 16546-95010
CATERPILLAR 5W-2716
INTERNATIONAL HARVESTER
681545 R1



Primary Filter uses AS-5523
Set Filter uses AS-6116-S

H 1 : 383 (mm)
H 2 : 381 (mm)
OD 1 : 123 (mm)
OD 2 : 106 (mm)
ID 1 : 93 (mm)
ID 2 : 17 (mm)

CONT : 9
VOL : 0.074

165

Sakura Filter

Technical Specification

A-7915 Air Filter Secondary Metal End Cap Element



CATERPILLAR 1N-8164
CATERPILLAR 4N-9164
INGERSOLL RAND 50616408

Primary Filter uses A-7912
Set Filter uses A-7912-S
H 1 : 432.7 (mm)
H 2 : 423 (mm)
OD 1 : 220 (mm)
OD 2 : 220 (mm)
ID 1 : 179 (mm)
ID 2 : 23 (mm)

CONT : 4
VOL : 0.104

166

A-85045 Air Filter Primary Soft PU end cap Element



YANMAR 119655-12560
KOMATSU 11965512560
KUBOTA 1G659-11220

H 1 : 187 (mm)
H 2 : 179 (mm)
OD 1 : 88.5 (mm)
OD 2 : 88.5 (mm)
ID 1 : 46 (mm)

CONT : 25
VOL : 0.054

Note : Flame Retardant version from A-8504

171

A-8508 Air Filter Primary Soft PU end cap Element



CATERPILLAR 131-8822

Secondary Filter uses A-8507
Set Filter uses A-8604-S
H 1 : 343 (mm)
H 2 : 330 (mm)
OD 1 : 237 (mm)
OD 2 : 237 (mm)
ID 1 : 132 (mm)

CONT : 1
VOL : 0.023

176

A-7964 Air Filter Secondary Metal End Cap Element



IVECO 08015449
MASSEY-FERGUSON 1093683M91
FIAT-ALLIS 1909964

Primary Filter uses AS-7988
Set Filter uses AS-7988-S
H 1 : 357 (mm)
H 2 : 355.5 (mm)
OD 1 : 105 (mm)
OD 2 : 85.5 (mm)
ID 1 : 73.5 (mm)
ID 2 : 17 (mm)

CONT : 25
VOL : 0.139

Note : Is a Secondary Air filter for AS-7988,AS-7813,AS-7805,AS-4304

167

A-8505 Air Filter Primary Soft PU end cap Element



OPEL 1#123 84 075
OPEL 1-12384075

Secondary Filter uses A-8599
Set Filter uses A-8602-S
H 1 : 312 (mm)
H 2 : 304 (mm)
OD 1 : 127.5 (mm)
OD 2 : 127.5 (mm)
ID 1 : 83 (mm)

CONT : 16
VOL : 0.109

Note : For Flame Retardant version, use A-76410

172

A-8508M Air Filter Primary Soft PU+Metal Element



CATERPILLAR 131-8822

Secondary Filter uses A-8507
Set Filter uses A-8508M-S
H 1 : 343 (mm)
H 2 : 330 (mm)
OD 1 : 237 (mm)
OD 2 : 237 (mm)
ID 1 : 132 (mm)

CONT : 1
VOL : 0.024

177

A-7967 Air Filter Secondary Metal End Cap Element



ISUZU 1-14215089-0
NISSAN 16546-96065
KOBELCO 2446U250S-2

Primary Filter uses A-1828
Set Filter uses A-1840-S
H 1 : 495.7 (mm)
H 2 : 483 (mm)
OD 1 : 162.3 (mm)
OD 2 : 162.3 (mm)
ID 1 : 134 (mm)
ID 2 : 17 (mm)

CONT : 9
VOL : 0.152

168

A-8506 Air Filter Primary Soft PU end cap Element



CASE 222425A1
ISUZU 8-97231900-0
JOHN DEERE KV16428

Secondary Filter uses A-8565

H 1 : 330.8 (mm)
H 2 : 322 (mm)
OD 1 : 138 (mm)
OD 2 : 138 (mm)
ID 1 : 81 (mm)

CONT : 12
VOL : 0.099

173

A-8508M-S Air Filter Set Soft PU+Metal Element



CATERPILLAR 1318822+1318821

Primary Filter uses A-8508M
Secondary Filter uses A-8507
H 1 : 343 (mm)
H 2 : 330 (mm)
OD 1 : 237 (mm)
OD 2 : 237 (mm)
ID 1 : 132 (mm)

CONT : 1
VOL : 0.024

178

A-8103 Air Filter Secondary Soft PU end cap Element



WIRTGEN 191525
CATERPILLAR 245-3819
ATLAS COPCO 2914-5018-00

Primary Filter uses A-8649
Set Filter uses A-8649-S
H 1 : 577 (mm)
H 2 : 572 (mm)
OD 1 : 196 (mm)
OD 2 : 194 (mm)
ID 1 : 179 (mm)

CONT : 9
VOL : 0.244

169

A-8506-S Air Filter Set Soft PU end cap Element



CASE 222425A1+222429A1
JOHN DEERE KV16428+AP33331

Primary Filter uses A-8506
Secondary Filter uses A-8565
H 1 : 330.8 (mm)
H 2 : 322 (mm)
OD 1 : 138 (mm)
OD 2 : 138 (mm)
ID 1 : 81 (mm)

CONT : 12
VOL : 0.101

174

A-85134 Air Filter Primary Soft PU end cap Element



KOMATSU 3EB01A5391
TCM 53651-72061
CATERPILLAR 91B6100912

Secondary Filter uses A-8569
Set Filter uses A-85134-S
H 1 : 273.5 (mm)
H 2 : 265 (mm)
OD 1 : 104 (mm)
OD 2 : 104 (mm)
ID 1 : 61 (mm)

CONT : 25
VOL : 0.110

Note : Is a Flame Retardant Media Version From A-8513

179

A-8504 Air Filter Primary Soft PU end cap Element



YANMAR 119655-12560
KOMATSU 11965512560
KUBOTA 1G659-11220

Secondary Filter uses A-7618
Set Filter uses A-7620-S
H 1 : 187 (mm)
H 2 : 179 (mm)
OD 1 : 88.5 (mm)
OD 2 : 88.5 (mm)
ID 1 : 46 (mm)

CONT : 25
VOL : 0.054

170

A-8507 Air Filter Secondary Soft PU end cap Element



CATERPILLAR 131-8821

Primary Filter uses A-8508
Set Filter uses A-8604-S
H 1 : 323 (mm)
H 2 : 317 (mm)
OD 1 : 134 (mm)
OD 2 : 125 (mm)
ID 1 : 95.5 (mm)

CONT : 25
VOL : 0.187

175

A-85400 Air Filter Hard PU end cap Element inside-out flow



FIAT-ALLIS 70185824
CLARK 945755
FARR P48

H 1 : 205 (mm)
Length 1 : 502 (mm)
Width 1 : 385 (mm)

CONT : 1
VOL : 0.051

Note : 48 Tubes--6 x 8

180

Sakura Filter

Technical Specification

A-85410 Air Filter Hard PU end cap Element inside-out flow

CATERPILLAR 8T4566
CLARK 946595
FARR P64



H 1 : 206 (mm)
Length 1 : 500 (mm)
Width 1 : 500 (mm)

CONT : 1
VOL : 0.066

Note : 64 Tubes--8 x 8

A-8599 Air Filter Secondary Soft PU end cap Element

KUBOTA 119005-12571
CASE 133721A1
HITACHI 4326841



Primary Filter uses A-8505
Set Filter uses A-8602-S
H 1 : 303.5 (mm)
H 2 : 298 (mm)
OD 1 : 83 (mm)
OD 2 : 79 (mm)
ID 1 : 64 (mm)

CONT : 25
VOL : 0.076

Note : Is a Secondary Air filter for A-5669,A-8505

A-8670 Air Filter Secondary Soft PU end cap Element

CASE 187472A1
CASE 187472A2
MASSEY-FERGUSON 4270036M1
NEW HOLLAND (CNH) 8602996



Primary Filter uses A-8671
Set Filter uses A-8672-S
H 1 : 385 (mm)
H 2 : 380 (mm)
OD 1 : 107.5 (mm)
OD 2 : 101.5 (mm)
ID 1 : 89 (mm)

CONT : 25
VOL : 0.152

A-8553 Air Filter Primary Soft PU end cap Element

YANMAR 129948-12621
VOLVO (TRUCK/VCE/VME/PENTA) 14255046
KUBOTA 1G377-11210

Secondary Filter uses A-8554
Set Filter uses A-8553-S
H 1 : 362 (mm)
H 2 : 328 (mm)
OD 1 : 149 (mm)
OD 2 : 149 (mm)
ID 1 : 84 (mm)

CONT : 12
VOL : 0.120

A-8604-S Air Filter Set Soft PU end cap Element

CATERPILLAR 1318822+1318821



Primary Filter uses A-8508
Secondary Filter uses A-8507
H 1 : 330 (mm)
H 2 : 317 (mm)
OD 1 : 237 (mm)
OD 2 : 237 (mm)
ID 1 : 130 (mm)

CONT : 1
VOL : 0.025

A-8678 Air Filter Soft PU end cap Element

CATERPILLAR 1G-7197
HATZ 409 529 00.0



H 1 : 92 (mm)
H 2 : 85 (mm)
OD 1 : 245 (mm)
OD 2 : 163 (mm)
ID 1 : 142 (mm)
ID 2 : 60 (mm)

CONT : 20
VOL : 0.101

A-8554 Air Filter Soft PU end cap Element

KHD(KLOCKNER-HUMBOLT-DEUTZ) 118 0870
YANMAR 129948-12630
VOLVO (TRUCK/VCE/VME/PENTA) 14255061
MASSEY-FERGUSON 3901465M2

H 1 : 345 (mm)
H 2 : 342 (mm)
OD 1 : 75 (mm)
OD 2 : 77 (mm)
ID 1 : 62 (mm)

CONT : 25
VOL : 0.104

A-8610 Air Filter Secondary Soft PU end cap Element

NEW HOLLAND (CNH) 1930592



Primary Filter uses A-7002
Set Filter uses A-70020-S
H 1 : 287.5 (mm)
H 2 : 281 (mm)
OD 1 : 59 (mm)
OD 2 : 58.5 (mm)
ID 1 : 45 (mm)

CONT : 25
VOL : 0.055

A-8686 Air Filter Primary Soft PU end cap Element

CATERPILLAR 246-5009
CASE-IH CNH 87417040
JOHN DEERE AH170798



Secondary Filter uses A-7626
Set Filter uses A-7627-S
H 1 : 633 (mm)
H 2 : 620 (mm)
OD 1 : 362 (mm)
OD 2 : 362 (mm)
ID 1 : 229 (mm)

CONT : 1
VOL : 0.091

A-8578 Air Filter Secondary Soft PU end cap Element

J.C.BAMFORD 32/912902
KOMATSU 42X01H0P01
KOMATSU 600-185-3120



Primary Filter uses A-8577
Set Filter uses A-8577-S
H 1 : 407.5 (mm)
H 2 : 401 (mm)
OD 1 : 107 (mm)
OD 2 : 100 (mm)
ID 1 : 87 (mm)

CONT : 25
VOL : 0.193

A-8651 Air Filter Secondary Soft PU end cap Element

HITACHI 4459548
KOMATSU 600-185-4220
JOHN DEERE F434395
CASE IH275810A1



Primary Filter uses A-8650
Set Filter uses A-8652-S
H 1 : 502 (mm)
H 2 : 497 (mm)
OD 1 : 150 (mm)
OD 2 : 141.5 (mm)
ID 1 : 109 (mm)

CONT : 9
VOL : 0.134

Note : Is a long life version of A-5103

A-9205 Air Filter Secondary Metal End Cap Element

CATERPILLAR 3I-0105
KOMATSU 581-02-12130
EUCLID 9038349



Primary Filter uses A-9218
H 1 : 571.75 (mm)
H 2 : 559 (mm)
OD 1 : 301.5 (mm)
OD 2 : 301.5 (mm)
ID 1 : 260.5 (mm)
ID 2 : 23 (mm)

CONT : 1
VOL : 0.063

A-8580 Air Filter Secondary Soft PU end cap Element

CATERPILLAR 142-1403
ATLAS COPCO 3222-1881-92
HITACHI 4466268



Primary Filter uses A-8579
Set Filter uses A-8579-S
H 1 : 500 (mm)
H 2 : 494 (mm)
OD 1 : 179 (mm)
OD 2 : 174 (mm)
ID 1 : 148 (mm)

CONT : 1
VOL : 0.019

Note : Is a Secondary Air filter of A-8579M,A-8665M

A-8665M Air Filter Primary Soft PU+Metal Element

SCANIA 1387548



Secondary Filter uses A-83090
Set Filter uses A-86651M-S
H 1 : 544 (mm)
H 2 : 515 (mm)
OD 1 : 308 (mm)
OD 2 : 308 (mm)
ID 1 : 177.5 (mm)

CONT : 1
VOL : 0.060

Note : Is a Primary Air Filter of A-83090,A-8580

A-9226 Air Filter Primary Metal End Cap Element

MASSEY-FERGUSON 3074305 M1
CATERPILLAR 3I-0838



Secondary Filter uses A-6009
Set Filter uses A-9226-S
H 1 : 419.3 (mm)
H 2 : 406.5 (mm)
OD 1 : 234 (mm)
OD 2 : 234 (mm)
ID 1 : 123 (mm)
ID 2 : 17 (mm)

CONT : 4
VOL : 0.115

AH-5502 Air Filter Rigid PU end cap Disposable Housing
CATERPILLAR 7C-1571



H 1 : 238 (mm)
H 2 : 203 (mm)
Intake Connection Height : 35 (mm)
Outside Housing OD 1 : 318 (mm)
Outside Housing OD 2 : 318 (mm)
Intake Connection ID 1 : 155 (mm)

CONT : 4
VOL : 0.120

196

AS-5523 Air Filter Primary Metal End Cap Element With Sleeve
NISSAN 16546-95009
KOBELCO 2446R277S5
FIAT 266787



Secondary Filter uses A-7913
Set Filter uses AS-6116-S
H 1 : 418.7 (mm)
H 2 : 406 (mm)
OD 1 : 225 (mm)
OD 2 : 174 (mm)
ID 1 : 107.5 (mm)
ID 2 : 17 (mm)

CONT : 4
VOL : 0.115

201

AS-7989-S Air Filter Set Metal End Cap Element With Sleeve
CATERPILLAR 6I-6434+3I-0266



Primary Filter uses AS-7989
Secondary Filter uses A-7611
H 1 : 317.7 (mm)
H 2 : 305 (mm)
OD 1 : 200 (mm)
OD 2 : 216.5 (mm)
ID 1 : 88 (mm)
ID 2 : 17 (mm)

CONT : 4
VOL : 0.079

206

AH-7001 Air Filter Rigid PU end cap Disposable Housing
FIAT 135637
DEUTZ 1356376
CATERPILLAR 3I-0008
FIAT 71356376
CATERPILLAR 8X-4575



H 1 : 179 (mm)
H 2 : 114 (mm)
Intake Connection Height : 35 (mm)
Outside Housing OD 1 : 116.5 (mm)
Outside Housing OD 2 : 116.5 (mm)
Intake Connection ID 1 : 47 (mm)

CONT : 18
VOL : 0.050

197

AS-5656-S Air Filter Set Metal End Cap Element With Sleeve
KOMATSU 600-181-9500



Primary Filter uses AS-7805
Secondary Filter uses A-7806
H 1 : 392 (mm)
H 2 : 381 (mm)
OD 1 : 199.3 (mm)
OD 2 : 155 (mm)
ID 1 : 88 (mm)
ID 2 : 17 (mm)

CONT : 9
VOL : 0.181

202

AS-8577 Air Filter Primary Soft PU end cap Element With Sleeve
CATERPILLAR 1527217
J.C.BAMFORD 32/912901
NEW HOLLAND (GNH) 82034620
FENDT H515200090100



Secondary Filter uses A-8578
Set Filter uses AS-8577-S
H 1 : 423 (mm)
H 2 : 410 (mm)
OD 1 : 207 (mm)
OD 2 : 207 (mm)
ID 1 : 106.5 (mm)

CONT : 1
VOL : 0.021

Note : For Flame Retardant version use AS-8577A

207

AS-2212 Air Filter Primary Metal End Cap Element With Sleeve
FIAT 1930603
FIAT 71415282



Secondary Filter uses A-7809
Set Filter uses AS-2212-S
H 1 : 420 (mm)
H 2 : 407.5 (mm)
OD 1 : 254 (mm)
OD 2 : 278.5 (mm)
ID 1 : 135.5 (mm)
ID 2 : 15 (mm)

CONT : 1
VOL : 0.037

198

AS-5708 Air Filter Metal End Cap Element With Sleeve
CUMMINS 158877
CUMMINS 299353



H 1 : 266.75 (mm)
H 2 : 254 (mm)
OD 1 : 296 (mm)
OD 2 : 234 (mm)
ID 1 : 123 (mm)
ID 2 : 14 (mm)

CONT : 1
VOL : 0.027

Note : Sleeve On E/C "B" Type Uses AS-5709

203

C-5103 Oil Filter Full Flow Spin-On
MASSEY-FERGUSON 1447082-M1
MASSEY-FERGUSON 1447082-M91
PERKINS 2654408



H 1 : 140 (mm)
OD 1 : 76 (mm)
Thread Size : 3/4-16 UNF-2B
BPV (kg/cm2) : 1.0
Gasket Type : Square

CONT : 50
VOL : 0.053

208

AS-2212-S Air Filter Set Metal End Cap Element With Sleeve
FIAT 1930603+1930790



Primary Filter uses AS-2212
Secondary Filter uses A-7809
H 1 : 420 (mm)
H 2 : 407.5 (mm)
OD 1 : 254 (mm)
OD 2 : 278.5 (mm)
ID 1 : 135.5 (mm)
ID 2 : 15 (mm)

CONT : 1
VOL : 0.038

199

AS-7805 Air Filter Primary Metal End Cap Element With Sleeve
IVECO 08014390
MASSEY-FERGUSON 1093682M91
ISUZU 14215-166



Secondary Filter uses A-7806
Set Filter uses AS-5656-S
H 1 : 392 (mm)
H 2 : 381 (mm)
OD 1 : 199 (mm)
OD 2 : 155 (mm)
ID 1 : 88 (mm)
ID 2 : 17 (mm)
Gasket Type : Square

CONT : 9
VOL : 0.167

Note : Long Life Versions Uses AS-7813

204

C-51070 Oil Filter Full Flow Spin-On
PERKINS 2654A111



H 1 : 206 (mm)
OD 1 : 94 (mm)
Thread Size : M24X1.5-6H
Gasket Type : Square

CONT : 12
VOL : 0.030

209

AS-5002 Air Filter Metal End Cap Element With Sleeve
CATERPILLAR 2N-1990
FORD PN 1990



H 1 : 215.7 (mm)
H 2 : 203 (mm)
OD 1 : 296 (mm)
OD 2 : 234 (mm)
ID 1 : 123 (mm)
ID 2 : 16.5 (mm)

CONT : 1
VOL : 0.025

200

AS-7989 Air Filter Primary Metal End Cap Element With Sleeve
KOBELCO 2446U264S2
CATERPILLAR 6I6434



Secondary Filter uses A-7611
Set Filter uses AS-7989-S
H 1 : 317.8 (mm)
H 2 : 305 (mm)
OD 1 : 200 (mm)
OD 2 : 216.5 (mm)
ID 1 : 88 (mm)
ID 2 : 17 (mm)

CONT : 4
VOL : 0.077

205

C-5504 Oil Filter Full Flow Spin-On
CATERPILLAR 1R-0734
CATERPILLAR 9L-9054
CATERPILLAR 9L-9200



H 1 : 143 (mm)
OD 1 : 93 (mm)
Thread Size : 1-12 UNF-2B
BPV (kg/cm2) : 1.0
Gasket Type : Square

CONT : 25
VOL : 0.041

210

Sakura Filter

Technical Specification

C-5506 Oil Filter Full Flow Spin-On
CATERPILLAR 1R-0739



H 1 : 255 (mm)
OD 1 : 108 (mm)
Thread Size : 1 1/8-16 UNF-2B

CONT : 6
VOL : 0.027

211

C-7906 Oil Filter Full Flow Spin-On
BRITISH LEYLAND HAJ8423



H 1 : 208 (mm)
OD 1 : 136 (mm)
Thread Size : 1 1/2-16 UN-2B
Gasket Type : Square

CONT : 6
VOL : 0.030

216

CA-55060 Cabin Air Filter Metal framed Element
CATERPILLAR 119-3355
CATERPILLAR 268-6704



H 1 : 65.35 (mm)
Length 1 : 405 (mm)
Width 1 : 200 (mm)

CONT : 10
VOL : 0.079

221

C-5703 Oil Filter Full Flow Spin-On
HYUNDAI 11E1-70110
GENERAL MOTORS 25011995
CUMMINS 3903224
KOMATSU 6732-51-5140
CASE J908616



H 1 : 135 (mm)
OD 1 : 93 (mm)
Thread Size : 1-16 UNF-2B
Gasket Type : Square

CONT : 12
VOL : 0.018

212

C-7916 Oil Filter Combination Spin-On
CATERPILLAR 5I-7950
CATERPILLAR 5I-7950X



H 1 : 220 (mm)
OD 1 : 108 (mm)
Thread Size : M32X1.5-6H
Gasket Type : Round

CONT : 6
VOL : 0.022

217

CA-55070 Cabin Air Filter Metal framed Element
CATERPILLAR 7X-6041



H 1 : 65.35 (mm)
H 2 : 55.6 (mm)
Length 1 : 311 (mm)
Width 1 : 243 (mm)

CONT : 5
VOL : 0.036

222

C-5718 Oil Filter By Pass Spin-On
ISUZU 1-87310093-0
CATERPILLAR 1W-8845
J.C.BAMFORD 32/919502
HITACHI 4285964



H 1 : 246 (mm)
OD 1 : 115.5 (mm)
Thread Size : 1 3/8-16 UNF-2B

CONT : 6
VOL : 0.029

213

C-7955 Oil Filter Full Flow Spin-On
VALMET, VALTRA TRACTOR,
VALTRA-VL 20147133
STEYR-DAIMLER-PUCH
620.00.070.744



H 1 : 147 (mm)
OD 1 : 108 (mm)
Thread Size : M24X1.5-6H
Gasket Type : Square

CONT : 12
VOL : 0.030

218

CA-55100 Cabin Air Filter Foam Element
CATERPILLAR 186-8228



H 1 : 20 (mm)
Length 1 : 385 (mm)
Width 1 : 145 (mm)

CONT : 20
VOL : 0.046

223

C-5811 Oil Filter Full Flow Spin-On
MITSUBISHI 32A40-00100
MITSUBISHI 32A40-00101
MITSUBISHI 32A40-00400



H 1 : 100 (mm)
OD 1 : 102 (mm)
Thread Size : 1-12 UNF-2B
BPV (kg/cm2) : 1.0
ADBV : YES
Gasket Type : Square

CONT : 12
VOL : 0.020

214

CA-44360 Cabin Air Filter Metal End Cap Element With Wing Nut
CATERPILLAR 211-2661



H 1 : 240.5 (mm)
H 2 : 227.8 (mm)
OD 1 : 155 (mm)
OD 2 : 155 (mm)
ID 1 : 88 (mm)
ID 2 : 17 (mm)

CONT : 12
VOL : 0.103

219

CA-55110 Cabin Air Filter Soft PU framed Element
CATERPILLAR 211-2660



H 1 : 37.5 (mm)
Length 1 : 404 (mm)
Width 1 : 168 (mm)

CONT : 20
VOL : 0.066

224

C-6218 Oil Filter Full Flow Spin-On
CATERPILLAR 1R-0734
FORD 5000 861
KUBOTA 60021-1623-0



H 1 : 140.5 (mm)
OD 1 : 93 (mm)
Thread Size : 1-12 UNF-2B
BPV (kg/cm2) : 1.0
Gasket Type : Square

CONT : 12
VOL : 0.022

215

CA-5501 Cabin Air Filter Metal framed Element
CATERPILLAR 7T-7358

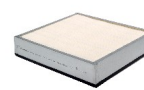

H 1 : 65.7 (mm)
Length 1 : 325 (mm)
Width 1 : 306 (mm)

CONT : 5
VOL : 0.047

220

CA-55120 Cabin Air Filter Metal framed Element
CATERPILLAR 9X-8216



H 1 : 60.5 (mm)
Length 1 : 684 (mm)
Width 1 : 153 (mm)

CONT : 1
VOL : 0.000

225

Sakura Filter

Technical Specification

CA-55140 Cabin Air Filter Metal framed Element
CATERPILLAR 6T-0988



H 1 : 65.5 (mm)
H 2 : 55.5 (mm)
Length 1 : 539 (mm)
Width 1 : 150 (mm)

CONT : 10
VOL : 0.073

226

EF-5103 Fuel Filter Eco Element High Efficiency
PERKINS 996453
PERKINS CH10930



H 1 : 234 (mm)
OD 1 : 115 (mm)
OD 2 : 115 (mm)
ID 1 : 55 (mm)
ID 2 : 49 (mm)

CONT : 20
VOL : 0.080

231

EO-5101 Oil Filter Full Flow Eco Element with adhesive
PERKINS 996452
PERKINS CH 10929



H 1 : 266 (mm)
OD 1 : 123 (mm)
OD 2 : 123 (mm)
ID 1 : 42.5 (mm)
ID 2 : 52 (mm)

CONT : 20
VOL : 0.105

236

CA-55150 Cabin Air Filter Metal framed Element
CATERPILLAR 232-1732



H 1 : 65.5 (mm)
Length 1 : 380 (mm)
Width 1 : 102 (mm)

CONT : 20
VOL : 0.073

Note : uses 2 filter per application

227

EF-55030 Fuel Filter Eco Element
CATERPILLAR 360-8959



H 1 : 234 (mm)
H 2 : 181 (mm)
OD 1 : 82 (mm)
OD 2 : 66.5 (mm)
ID 1 : 15.2 (mm)

CONT : 25
VOL : 0.055

232

F-5210 Fuel Filter Metal End Cap Element
YANMAR 129100-55650
KUBOTA 15521-43160
KUBOTA 607



H 1 : 89 (mm)
OD 1 : 50 (mm)
OD 2 : 50 (mm)
ID 1 : 20 (mm)

CONT : 50
VOL : 0.017

237

CA-55160 Cabin Air Filter Soft PU framed Element
CATERPILLAR 259-3222



H 1 : 59.7 (mm)
Length 1 : 366.9 (mm)
Length 2 : 355.8 (mm)
Width 1 : 153.3 (mm)
Width 2 : 142.9 (mm)

CONT : 20
VOL : 0.097

228

EF-55040 Fuel Filter Eco Element
CATERPILLAR 360-8960



H 1 : 155.5 (mm)
H 2 : 140.5 (mm)
OD 1 : 82 (mm)
OD 2 : 66.5 (mm)
ID 1 : 15.2 (mm)

CONT : 50
VOL : 0.065

233

F-5501 Fuel Filter Metal End Cap Element
CATERPILLAR 4H-8792
CATERPILLAR 9H-4729



H 1 : 164 (mm)
H 2 : 160.5 (mm)
OD 1 : 88 (mm)
OD 2 : 88 (mm)
ID 1 : 25 (mm)
ID 2 : 25 (mm)

CONT : 25
VOL : 0.042

Note : Paper Protector

238

CA-55850 Cabin Air Filter Metal framed Element
CATERPILLAR 4I-1278



H 1 : 24 (mm)
Length 1 : 600 (mm)
Width 1 : 123.5 (mm)

CONT : 10
VOL : 0.032

229

EH-55010 Hydraulic Oil Filter Transmission Eco Element with adhesive
CATERPILLAR 1R-1809
CATERPILLAR 328-3655
CATERPILLAR 338-3540



H 1 : 266 (mm)
OD 1 : 124 (mm)
OD 2 : 123 (mm)
ID 1 : 52 (mm)

CONT : 20
VOL : 0.103

Note : Hight efficiency

234

F-5503 Fuel Filter Metal End Cap Element
CATERPILLAR 5S-7645



H 1 : 69 (mm)
H 2 : 43.6 (mm)
OD 1 : 29 (mm)
OD 2 : 29 (mm)
Thread Stud Size : M4X0.7-6H

CONT : 100
VOL : 0.010

Note : Tread stud M4X0.7

239

EF-5101 Fuel Filter Eco Element High Efficiency
PERKINS 996454
PERKINS CH10931



H 1 : 263 (mm)
OD 1 : 124 (mm)
OD 2 : 123 (mm)
ID 1 : 52 (mm)
ID 2 : 44 (mm)

CONT : 20
VOL : 0.103

230

EH-55040 Hydraulic Oil Filter Return Eco Element
CATERPILLAR 362-1163



H 1 : 298 (mm)
H 2 : 274 (mm)
OD 1 : 107 (mm)
OD 2 : 107 (mm)
ID 1 : 38 (mm)

CONT : 25
VOL : 0.139

235

F-5504 Fuel Filter Metal End Cap Element
CATERPILLAR 1R-0718
CATERPILLAR 8N-9850



H 1 : 236 (mm)
H 2 : 230 (mm)
OD 1 : 101.6 (mm)
OD 2 : 101.6 (mm)
ID 1 : 44 (mm)
ID 2 : 44 (mm)

CONT : 20
VOL : 0.076

Note : Paper Protector

240

Sakura Filter

Technical Specification

F-5505 Fuel Filter Metal End Cap Element

CATERPILLAR 5M-7650
CATERPILLAR 5M-7663
CATERPILLAR 9M-2341



H 1 : 76 (mm)
OD 1 : 55.5 (mm)
OD 2 : 55.5 (mm)
ID 1 : 10 (mm)
ID 2 : 10 (mm)

CONT : 100
VOL : 0.034

Note : Paper Wire Mesh

241

FC-5101 Fuel Filter Can-type Housing

MASSEY-FERGUSON 1896287M91
PEUGEOT 1906.12



H 1 : 113 (mm)
OD 1 : 84 (mm)
OD 2 : 87.3 (mm)
ID 1 : 19 (mm)
ID 2 : 19 (mm)

CONT : 50
VOL : 0.054

246

FC-5504 Fuel Filter Secondary Spin-On High Efficiency

CATERPILLAR 1R-0751
CATERPILLAR 1R-0759
CATERPILLAR 6I-4783



H 1 : 174 (mm)
OD 1 : 93 (mm)
Thread Size : 7/8-14 UNF-2B
Gasket Type : Square

CONT : 12
VOL : 0.023

Note : Aluminium casting & seamless version uses FC-5515

251

F-5506 Fuel Filter Metal End Cap Element

CATERPILLAR 9M-2342



H 1 : 153 (mm)
OD 1 : 55.5 (mm)
OD 2 : 55.5 (mm)
ID 1 : 10 (mm)
ID 2 : 10 (mm)

CONT : 50
VOL : 0.034

Note : Paper Wire Mesh

242

FC-5103 Fuel Filter Can-type Housing

ALLIS CHALMERS 1919100
MANITOU 49660
CASE K915319



H 1 : 71 (mm)
OD 1 : 85 (mm)
OD 2 : 89 (mm)
ID 1 : 39 (mm)
ID 2 : 15 (mm)

CONT : 50
VOL : 0.036

247

FC-5506 Fuel Filter Spin-On

CATERPILLAR 1R-0715
CATERPILLAR 8N-3080
CATERPILLAR 8N-3500



H 1 : 305 (mm)
OD 1 : 136 (mm)
Thread Size : 1 3/8-16 UNF-2B
Gasket Type : Square

CONT : 6
VOL : 0.046

252

F-55200 Fuel Filter Metal End Cap Element High Efficiency

CATERPILLAR 1R0725
CATERPILLAR 1R0766
CATERPILLAR 1W4056



H 1 : 261.4 (mm)
OD 1 : 128.5 (mm)
OD 2 : 128.5 (mm)
ID 1 : 58 (mm)
ID 2 : 58 (mm)

CONT : 6
VOL : 0.033

243

FC-51170 Fuel Filter aluminium casting Spin-On High Efficiency

PERKINS 2656F843
CATERPILLAR 299-8229
MANITOU 747351



H 1 : 144.8 (mm)
OD 1 : 86 (mm)
Thread Size : M12X1.5-6H
Gasket Type : Square

CONT : 12
VOL : 0.022

Note : with glass fiber media

248

FC-5507 Fuel Filter Secondary Spin-On High Efficiency

CATERPILLAR 1R-0740
CATERPILLAR 1R-0750
INGERSOLL RAND 35310549



H 1 : 174 (mm)
OD 1 : 93 (mm)
Thread Size : 1-14 UNS-2B
Gasket Type : Square

CONT : 12
VOL : 0.026

253

F-6505 Fuel Filter Metal End Cap Element

EUCLID 5574961
GENERAL MOTORS 5574961



H 1 : 139 (mm)
H 2 : 134 (mm)
OD 1 : 74 (mm)
OD 2 : 74 (mm)
ID 1 : 26 (mm)
ID 2 : 26 (mm)

CONT : 50
VOL : 0.050

244

FC-5502 Fuel Filter Spin-On

CATERPILLAR 4N-5823



H 1 : 262 (mm)
OD 1 : 108 (mm)
Thread Size : 1-14 UNS-2B
Gasket Type : Square

CONT : 6
VOL : 0.026

249

FC-5508 Fuel Filter Spin-On High Efficiency

CATERPILLAR 1R-0753



H 1 : 233 (mm)
OD 1 : 93 (mm)
Thread Size : 7/8-14 UNF-2B
Gasket Type : Square

CONT : 12
VOL : 0.034

254

FC-1007 Fuel Filter Spin-On

CATERPILLAR 103-2901
TOYOTA 233203391071



H 1 : 100 (mm)
H 2 : 100 (mm)
OD 1 : 80 (mm)
Thread Size : M20X1.5-6H
Gasket Type : Round

CONT : 50
VOL : 0.041

245

FC-5503 Fuel Filter Spin-On

CATERPILLAR 1R-0710
CATERPILLAR 9L-9100



H 1 : 144 (mm)
OD 1 : 93 (mm)
Thread Size : 15/16-16 UNF-2B
Gasket Type : Square

CONT : 12
VOL : 0.020

250

FC-5510 Fuel Filter Spin-On High Efficiency

CATERPILLAR 1R-0755



H 1 : 305 (mm)
OD 1 : 136 (mm)
Thread Size : 1 3/8-16 UNF-2B
Gasket Type : Square

CONT : 6
VOL : 0.046

Note : media 4 micron

255

Sakura Filter

Technical Specification

FC-5515 Fuel Filter Secondary aluminium casting Spin-On High Efficiency

CATERPILLAR 1R-0751



H 1 : 180.4 (mm)
OD 1 : 86 (mm)
Thread Size : 7/8-14 UNF-2B

CONT : 12
VOL : 0.028

256

H-5001 Hydraulic Oil Filter Metal End Cap Element With Microfiber media

TAMROCK 81893749
FORD E8NNF882BA
PALL HC9600FUS8H



H 1 : 208 (mm)
H 2 : 204 (mm)
OD 1 : 79 (mm)
OD 2 : 79 (mm)
ID 1 : 42 (mm)

CONT : 25
VOL : 0.040

261

H-5504 Hydraulic Oil Filter Metal End Cap Element

CATERPILLAR 1R-0719
CATERPILLAR 2M-3943
CATERPILLAR 9M-9740



H 1 : 234 (mm)
OD 1 : 101 (mm)
OD 2 : 101 (mm)
ID 1 : 59 (mm)
ID 2 : 59 (mm)

CONT : 20
VOL : 0.071

266

FC-55151 Fuel Filter Secondary aluminium casting Spin-On High Efficiency



H 1 : 180.4 (mm)
OD 1 : 86 (mm)
Thread Size : 7/8-14 UNF-2B

CONT : 12
VOL : 0.022

Note : FC-5515(Media difference)

257

H-51170 Hydraulic Oil Filter Element

MASSEY-FERGUSON 516069-M94



H 1 : 181 (mm)
H 2 : 176 (mm)
OD 1 : 114 (mm)
OD 2 : 114 (mm)
ID 1 : 44.5 (mm)

CONT : 25
VOL : 0.071

262

H-5505 Hydraulic Oil Filter Metal End Cap Element

CATERPILLAR 094-4412
HITACHI 4219713



H 1 : 455 (mm)
H 2 : 450 (mm)
OD 1 : 150 (mm)
OD 2 : 150 (mm)
ID 1 : 110 (mm)
ID 2 : 110 (mm)

CONT : 6
VOL : 0.080

Note : With outer packing 1 pc

267

FC-5517 Fuel Filter Spin-On High Efficiency

CATERPILLAR 1R0762



H 1 : 266 (mm)
OD 1 : 93 (mm)
Thread Size : 1-14 UNS-2B
Gasket Type : Square

CONT : 12
VOL : 0.039

258

H-5501 Hydraulic Oil Filter Metal End Cap Element

CATERPILLAR 1R-0730
CATERPILLAR 2P-5834



H 1 : 144 (mm)
OD 1 : 77 (mm)
OD 2 : 77 (mm)
ID 1 : 26 (mm)

CONT : 25
VOL : 0.033

263

H-5506 Hydraulic Oil Filter Metal End Cap Element with synthetic media

CATERPILLAR 1R-0722
CATERPILLAR 9J-0750
CATERPILLAR 9J-5461



H 1 : 278 (mm)
OD 1 : 130 (mm)
OD 2 : 130 (mm)
ID 1 : 84.4 (mm)
ID 2 : 84.4 (mm)

CONT : 15
VOL : 0.093

268

FC-6206 Fuel Filter Spin-On

MERCEDES-BENZ 390 092 00 01
MERCEDES-BENZ A390 092 00 01



H 1 : 169 (mm)
OD 1 : 93.2 (mm)
Thread Size : 1-14 UNS-2B
Gasket Type : Square

CONT : 12
VOL : 0.025

259

H-5502 Hydraulic Oil Filter Metal End Cap Element Cellulose media

CATERPILLAR 1R-0728
CATERPILLAR 4J-0816



H 1 : 228 (mm)
OD 1 : 79 (mm)
OD 2 : 79 (mm)
ID 1 : 47.5 (mm)
ID 2 : 47.5 (mm)

CONT : 25
VOL : 0.048

Note : Performance grade uses H-5508

264

H-5507 Hydraulic Oil Filter Wire Mesh supported Element

CATERPILLAR 3S-3865
CATERPILLAR 3S-3875
CATERPILLAR 3S-3875X



H 1 : 230 (mm)
OD 1 : 85.6 (mm)
OD 2 : 85.6 (mm)
ID 1 : 45.8 (mm)

CONT : 25
VOL : 0.066

269

FS-5701 Fuel Filter Metal body In-Line

CUMMINS 3826094
NEW HOLLAND (CNH) 86597473



H 1 : 96 (mm)
OD 1 : 44.5 (mm)
Inlet : 10 (mm)
Outlet : 10 (mm)

CONT : 12
VOL : 0.005

260

H-5503 Hydraulic Oil Filter Metal End Cap Element

CATERPILLAR 1R-0720
CATERPILLAR 4J-6064



H 1 : 228 (mm)
OD 1 : 130 (mm)
OD 2 : 130 (mm)
ID 1 : 84.4 (mm)
ID 2 : 84.4 (mm)

CONT : 20
VOL : 0.105

Note : Performance grade uses H-5526

265

H-5508 Hydraulic Oil Filter Metal End Cap Element With Microfiber media

CATERPILLAR 139-1532
CATERPILLAR 4J-0816
CATERPILLAR 4T-3130



H 1 : 228 (mm)
OD 1 : 79 (mm)
OD 2 : 79 (mm)
ID 1 : 47.5 (mm)
ID 2 : 47.5 (mm)

CONT : 25
VOL : 0.059

270

Sakura Filter

Technical Specification

H-5509 Hydraulic Oil Filter Metal End Cap Element
 CATERPILLAR 7J-0670
 CATERPILLAR 7J-670



H 1 : 229 (mm)
 OD 1 : 173 (mm)
 OD 2 : 173 (mm)
 ID 1 : 100 (mm)
 ID 2 : 100 (mm)

CONT : 9
 VOL : 0.083

271

H-5519 Hydraulic Oil Filter Metal End Cap Element
 SUMITOMO KRJ 1599



H 1 : 291 (mm)
 OD 1 : 112 (mm)
 OD 2 : 112 (mm)
 ID 1 : 70 (mm)
 ID 2 : 70 (mm)

CONT : 9
 VOL : 0.049

276

H-55320 Hydraulic Oil Filter Metal End Cap Element with synthetic media
 CATERPILLAR 3I-0589



H 1 : 231.9 (mm)
 OD 1 : 101 (mm)
 OD 2 : 101 (mm)
 ID 1 : 58 (mm)
 ID 2 : 58 (mm)

CONT : 12
 VOL : 0.045

281

H-5510 Hydraulic Oil Filter Metal End Cap Element
 CATERPILLAR 1R-0735
 CATERPILLAR 4T-0522
 CATERPILLAR 4T-0523



H 1 : 177.5 (mm)
 OD 1 : 130 (mm)
 OD 2 : 130 (mm)
 ID 1 : 84.4 (mm)
 ID 2 : 84.4 (mm)

CONT : 20
 VOL : 0.083

Note : H-5510 lower efficiency than H-55101

272

H-5522 Hydraulic Oil Filter Element With Microfiber media
 CATERPILLAR 179-9806



H 1 : 425 (mm)
 H 2 : 416.6 (mm)
 OD 1 : 142 (mm)
 OD 2 : 142 (mm)
 ID 1 : 97.2 (mm)
 ID 2 : 97.2 (mm)

CONT : 4
 VOL : 0.047

277

H-5640 Hydraulic Oil Filter Metal End Cap Element
 CASE 884879C1
 INTERNATIONAL HARVESTER 884879C1
 CASE D32212



H 1 : 122.5 (mm)
 H 2 : 117 (mm)
 OD 1 : 66 (mm)
 OD 2 : 66.5 (mm)
 ID 1 : 30 (mm)

CONT : 50
 VOL : 0.038

282

H-5513 Hydraulic Oil Filter Metal End Cap Element
 HUPPENKOTHEN BAUMASCHINEN 1551200601T
 CATERPILLAR 997352
 CASE KHJ 1493



H 1 : 79 (mm)
 H 2 : 75 (mm)
 OD 1 : 51 (mm)
 OD 2 : 53 (mm)
 ID 1 : 23 (mm)

CONT : 50
 VOL : 0.016

273

H-5526 Hydraulic Oil Filter Metal End Cap Element With Microfiber media
 CATERPILLAR 4J-6064
 CATERPILLAR 9W-6428



H 1 : 228 (mm)
 OD 1 : 130 (mm)
 OD 2 : 130 (mm)
 ID 1 : 85 (mm)
 ID 2 : 85 (mm)

CONT : 12
 VOL : 0.062

278

H-57030 Hydraulic Oil Filter Metal End Cap Element
 CASE-IH CNH 104929
 CASE-IH CNH 105892
 CATERPILLAR 3I0457
 CATERPILLAR 3I0473
 FIAT 4853388



H 1 : 408 (mm)
 H 2 : 406 (mm)
 OD 1 : 110 (mm)
 OD 2 : 110 (mm)
 ID 1 : 63 (mm)
 ID 2 : 20 (mm)

CONT : 9
 VOL : 0.069

283

H-5516 Hydraulic Oil Filter Suction Wire Mesh supported Element
 CATERPILLAR 4S-8598



H 1 : 154 (mm)
 OD 1 : 85.5 (mm)
 OD 2 : 85.5 (mm)
 ID 1 : 59 (mm)
 ID 2 : 45.8 (mm)

CONT : 50
 VOL : 0.074

274

H-55270 Hydraulic Oil Filter Metal End Cap Element with synthetic media
 CATERPILLAR 4T-3131



H 1 : 231 (mm)
 OD 1 : 101 (mm)
 OD 2 : 101 (mm)
 ID 1 : 59 (mm)
 ID 2 : 59 (mm)

CONT : 12
 VOL : 0.045

279

H-7916 Hydraulic Oil Filter Metal End Cap Element With Microfiber media
 PALL HC-9600FUP8H



H 1 : 207 (mm)
 H 2 : 203 (mm)
 OD 1 : 79 (mm)
 OD 2 : 79 (mm)
 ID 1 : 41.8 (mm)

CONT : 25
 VOL : 0.054

284

H-5517 Hydraulic Oil Filter Metal End Cap Element
 MASSEY-FERGUSON 1495479M1



H 1 : 230 (mm)
 OD 1 : 99 (mm)
 OD 2 : 99 (mm)
 ID 1 : 41 (mm)
 ID 2 : 41 (mm)

CONT : 20
 VOL : 0.076

275

H-55280 Hydraulic Oil Filter Metal End Cap Element with synthetic media
 CATERPILLAR 132-8876
 CATERPILLAR 4T-3132



H 1 : 228.2 (mm)
 H 2 : 225 (mm)
 OD 1 : 130 (mm)
 OD 2 : 130 (mm)
 ID 1 : 84.4 (mm)
 ID 2 : 84.4 (mm)

CONT : 6
 VOL : 0.031

280

H-79411 Hydraulic Oil Filter Metal End Cap Element
 MASSEY-FERGUSON 1022883M1
 CATERPILLAR 32-9868
 MASSEY-FERGUSON 577492M91



H 1 : 176 (mm)
 OD 1 : 113.8 (mm)
 OD 2 : 113.8 (mm)
 ID 1 : 44.7 (mm)
 ID 2 : 44.7 (mm)

CONT : 10
 VOL : 0.031

Note : with gaskets on end cap

285

Sakura Filter

Technical Specification

H-7942 Hydraulic Oil Filter Metal End Cap Element

CATERPILLAR 126-2081
CATERPILLAR 126-2081X



H 1 : 418 (mm)
H 2 : 415.5 (mm)
OD 1 : 142 (mm)
OD 2 : 142 (mm)
ID 1 : 97.4 (mm)
ID 2 : 97.4 (mm)

CONT : 6
VOL : 0.068

286

HC-5507 Hydraulic Oil Filter Spin-On Synthetic Media

CATERPILLAR 144-6691
DEUTZ 4118911
CLARK 6661248
NEW HOLLAND (CNH) 920019190



H 1 : 152 (mm)
OD 1 : 94.5 (mm)
Thread Size : 1 3/8-12 UNF-2B

CONT : 12
VOL : 0.024

291

HC-55170 Hydraulic Oil Filter Spin-On Synthetic Media

CATERPILLAR 1261813
CHARLES MACHINE 149939
CHARLES MACHINE 149939A
CATERPILLAR 311767
VERMEER 609135003



H 1 : 138 (mm)
OD 1 : 76 (mm)
Thread Size : 2-12 UNF-2B

CONT : 12
VOL : 0.016

Note : efficiency 10 micron absolute

296

HC-5501 Hydraulic Oil Filter Transmission Spin-On

CATERPILLAR 4T-7948
DAEWOO D140182
DAEWOO D140182S



H 1 : 111 (mm)
OD 1 : 93 (mm)
Thread Size : 13/16-16 UNF-2B
Gasket Type : Square

CONT : 12
VOL : 0.018

287

HC-5508 Hydraulic Oil Filter Spin-On Synthetic Media

KOMATSU 1281327H1
CASE 1346028C1
CATERPILLAR 9T5916



H 1 : 240 (mm)
OD 1 : 94.5 (mm)
Thread Size : 1 3/8-12 UNF-2B

CONT : 12
VOL : 0.036

Note : with Glass Fiber Media

292

HC-55200 Hydraulic Oil Filter Spin-On

CATERPILLAR 4I-3950



H 1 : 240 (mm)
OD 1 : 76.5 (mm)
Thread Size : 2-12 UNF-2B

CONT : 12
VOL : 0.027

297

HC-5503 Hydraulic Oil Filter Spin-On Synthetic Media

CATERPILLAR 1081153
INGERSOLL RAND 51302214
VOLVO BM 9658998



H 1 : 293 (mm)
OD 1 : 122 (mm)
Thread Size : 1 3/4-12 UNF-2B

CONT : 6
VOL : 0.034

Note : with Glass Fiber media

288

HC-55112 Hydraulic Oil Filter Spin-On

NEW HOLLAND (CNH) 86542664
CASE 87027972
CATERPILLAR 9T-5664
JOHN DEERE AT58368



H 1 : 173 (mm)
OD 1 : 123 (mm)
Top Thread Size : 1 1/2-16 UN-2B

CONT : 6
VOL : 0.025

293

HC-55220 Hydraulic Oil Filter Spin-On With Microfiber media

CATERPILLAR 1261815
CHARLES MACHINE 159074



H 1 : 152 (mm)
OD 1 : 94.5 (mm)
Thread Size : 1 3/8-12 UNF-2B

CONT : 12
VOL : 0.024

298

HC-5505 Hydraulic Oil Filter Spin-On Cellulose media

CATERPILLAR 184-3931
CATERPILLAR 413948



H 1 : 138 (mm)
OD 1 : 76 (mm)
Thread Size : 2-12 UNF-2B

CONT : 12
VOL : 0.019

Note : Glass Fiber media uses HC-55180

289

HC-5512 Hydraulic Oil Filter Spin-On Synthetic Media

CATERPILLAR 126-1817



H 1 : 293 (mm)
OD 1 : 116 (mm)
Thread Size : 1 3/4-12 UNF-2B

CONT : 6
VOL : 0.035

Note : Aluminium Casting

294

HC-55280 Hydraulic Oil Filter aluminium casting Spin-On Synthetic Media

CATERPILLAR 2254118



H 1 : 293 (mm)
OD 1 : 116 (mm)
Thread Size : 1 3/4-12 UNF-2B

CONT : 6
VOL : 0.033

299

HC-5506 Hydraulic Oil Filter Spin-On Synthetic Media

CATERPILLAR 310694
CASE A49386
JOHN DEERE AT112393



H 1 : 293 (mm)
OD 1 : 116 (mm)
Thread Size : 1 3/4-12 UNF-2B

CONT : 6
VOL : 0.035

Note : with glass fiber media

290

HC-5516 Hydraulic Oil Filter aluminium casting Spin-On Synthetic Media

CLARK 062827440
CATERPILLAR 1850337
CLARK 62827440
NEW HOLLAND (CNH) 86597482



H 1 : 240 (mm)
OD 1 : 76.5 (mm)
Thread Size : 2-12 UNF-2B

CONT : 12
VOL : 0.026

295

HC-55290 Hydraulic Oil Filter Spin-On Synthetic Media

CATERPILLAR 1440832
CATERPILLAR 2237809
CATERPILLAR 311914
INGERSOLL RAND 59888990
PALL HC7500SDN4H



H 1 : 173 (mm)
OD 1 : 123 (mm)
Thread Size : 1 1/2-16 UN-2B
Gasket Type : Square

CONT : 6
VOL : 0.023

300

Sakura Filter

Technical Specification

HC-55300 Hydraulic Oil Filter Spin-On

CATERPILLAR 126-1814
VOLVO 208151
VERMEER 609136003



H 1 : 240 (mm)
OD 1 : 76.5 (mm)
Thread Size : 2-12 UNF-2B

CONT : 12
VOL : 0.026

301

HC-7913 Hydraulic Oil Filter Spin-On

CLARK 234099
CATERPILLAR 3I1980
J.C.BAMFORD 4110147
FIAT 906041007



H 1 : 140 (mm)
OD 1 : 93.5 (mm)
Thread Size : 2-16 UNF-2B
Gasket Type : Square

CONT : 12
VOL : 0.022

306

O-5001 Oil Filter Full Flow Metal End Cap Element

HYSTER 991590
FORD A730X6731TA



H 1 : 115.5 (mm)
H 2 : 113.5 (mm)
OD 1 : 72 (mm)
OD 2 : 72 (mm)
ID 1 : 21 (mm)
ID 2 : 21 (mm)

CONT : 50
VOL : 0.038

Note : O-5001 paper protector version, O-5002 metal protector version

311

HC-55310 Hydraulic Oil Filter Spin-On With Microfiber media

CATERPILLAR 9T-6636



H 1 : 193 (mm)
OD 1 : 116 (mm)
Thread Size : 1 3/4-12 UNF-2B
Gasket Type : Round

CONT : 6
VOL : 0.024

302

HC-79331 Hydraulic Oil Filter Full Flow Spin-On

VOLVO 12754597



H 1 : 270 (mm)
OD 1 : 123 (mm)
Thread Size : 1 1/2-16 UN-2B
Gasket Type : Square

CONT : 6
VOL : 0.039

Note : HC-7933 (qty.outer packing difference)

307

O-5404 Oil Filter Full Flow Metal End Cap Element

CATERPILLAR 1R-0727
CATERPILLAR 8B-5935



H 1 : 150 (mm)
OD 1 : 94 (mm)
OD 2 : 94 (mm)
ID 1 : 39 (mm)
ID 2 : 39 (mm)

CONT : 25
VOL : 0.045

312

HC-5801 Hydraulic Oil Filter Spin-On

CATERPILLAR 093-7521
KUBOTA 172179-73720
CATERPILLAR 937520



H 1 : 172 (mm)
OD 1 : 93 (mm)
Thread Size : 1 1/8-16 UNF-2B
Gasket Type : Round

CONT : 12
VOL : 0.024

303

HC-7940 Hydraulic Oil Filter Spin-On

CASE 150794A1



H 1 : 136 (mm)
OD 1 : 93 (mm)
Thread Size : 1 1/8-16 UNF-2B
Gasket Type : Square

CONT : 12
VOL : 0.021

308

O-5501 Oil Filter Full Flow Metal End Cap Element

CATERPILLAR 5S-0484
CATERPILLAR 7M-3800



H 1 : 233 (mm)
OD 1 : 97 (mm)
OD 2 : 97 (mm)
ID 1 : 42 (mm)
ID 2 : 42 (mm)

CONT : 25
VOL : 0.068

Note : Paper Protector

313

HC-69031 Hydraulic Oil Filter Spin-On With Microfiber media

HYUNDAI 46321-22015
INGERSOLL RAND 575129311
CATERPILLAR 77-5795



H 1 : 147.5 (mm)
OD 1 : 94 (mm)
Thread Size : 1 1/2-16 UN-2B

CONT : 12
VOL : 0.022

Note : 5 micron

304

HC-9901 Hydraulic Oil Filter Spin-On

CATERPILLAR 5I-8670



H 1 : 155 (mm)
OD 1 : 82.5 (mm)
Thread Size : M45X2.0-6H
Gasket Type : Round

CONT : 12
VOL : 0.019

309

O-5502 Oil Filter Full Flow Metal End Cap Element

KOMATSU 145-29-22430
CATERPILLAR 1R-0659
CATERPILLAR 4W-4840



H 1 : 236 (mm)
H 2 : 230 (mm)
OD 1 : 101.6 (mm)
OD 2 : 101.6 (mm)
ID 1 : 44.3 (mm)
ID 2 : 44.3 (mm)

CONT : 20
VOL : 0.074

Note : Metal Protector

314

HC-76080 Hydraulic Oil Filter Spin-On Synthetic Media

CASE 1266751H2
CASE 294721A1
J.C.BAMFORD 32905501
NEW HOLLAND (CNH) 9821387
JOHN DEERE AL77061



H 1 : 152 (mm)
OD 1 : 94.5 (mm)
Thread Size : 1 3/8-12 UNF-2B

CONT : 12
VOL : 0.024

Note : with Glass Fiber Media

305

O-1006 Oil Filter Combination Metal End Cap Element

KOBELCO 2451U1721A
HYUNDAI 26316-93000
MITSUBISHI ME 034605



H 1 : 192 (mm)
H 2 : 191 (mm)
OD 1 : 110 (mm)
OD 2 : 100 (mm)
ID 1 : 33 (mm)
ID 2 : 19.2 (mm)

CONT : 25
VOL : 0.078

Note : Paper Protector

310

O-5503 Oil Filter Full Flow Metal End Cap Element

CATERPILLAR 1R-0721
CATERPILLAR 5S-0485
CATERPILLAR 5S485



H 1 : 229 (mm)
H 2 : 227 (mm)
OD 1 : 130 (mm)
OD 2 : 130 (mm)
ID 1 : 84.4 (mm)
ID 2 : 84.4 (mm)

CONT : 20
VOL : 0.100

315

Sakura Filter

Technical Specification

O-5504 Oil Filter Full Flow Metal End Cap Element

CATERPILLAR 4P-2839
CATERPILLAR 7N-7500



H 1 : 254 (mm)
OD 1 : 188.3 (mm)
OD 2 : 188.3 (mm)
ID 1 : 65 (mm)
ID 2 : 65 (mm)

CONT : 6
VOL : 0.086

316

SF-1912-2 Fuel/Water Separator Final Plastic Element 2 Micron

CATERPILLAR 4P-7384



H 1 : 244 (mm)
OD 1 : 111 (mm)
OD 2 : 128 (mm)
ID 1 : 16.5 (mm)
ID 2 : 21.15 (mm)

CONT : 25
VOL : 0.102

321

SFC-5504-30 Fuel/Water Separator Primary Spin-On 30 Micron

DAF 135 5891
NISSAN 16403-NY000
ISUZU 8-97605118-1



H 1 : 217 (mm)
OD 1 : 108 (mm)
Thread Size : 1-14 UNS-2B
Gasket Type : Square

CONT : 10
VOL : 0.037

Note : bowl not included

326

O-5505 Oil Filter Full Flow Metal End Cap Element

CATERPILLAR 1R0729
CATERPILLAR 1S9150
CATERPILLAR 4A-0332



H 1 : 233.5 (mm)
H 2 : 229.5 (mm)
OD 1 : 79 (mm)
OD 2 : 79 (mm)
ID 1 : 35 (mm)
ID 2 : 35 (mm)

CONT : 12
VOL : 0.028

317

SF-5704 Fuel/Water Separator Metal End Cap Element

CUMMINS 256559
CATERPILLAR 2W-4234
CATERPILLAR 8N-0205



H 1 : 220 (mm)
H 2 : 205 (mm)
OD 1 : 148 (mm)
OD 2 : 148 (mm)
ID 1 : 25 (mm)
ID 2 : 25 (mm)

CONT : 6
VOL : 0.039

322

SFC-5504-30B Fuel/Water Separator Primary Spin-On With Bowl 30 Micron

DAF 1355891
NISSAN 16403-NY000



Secondary Filter uses SFC-5504-10B

H 1 : 311 (mm)
H 2 : 217 (mm)
OD 1 : 108 (mm)
Thread Size : 1-14 UNS-2B
Gasket Type : Square

CONT : 10
VOL : 0.050

327

O-55090 Oil Filter Full Flow Metal End Cap Element

CATERPILLAR 179-1502
CATERPILLAR 1W4136



H 1 : 343 (mm)
Not Available : 340 (mm)
OD 1 : 187.5 (mm)
OD 2 : 187.5 (mm)
ID 1 : 87 (mm)
ID 2 : 87 (mm)

CONT : 1
VOL : 0.014

318

SFC-43040 Fuel/Water Separator Spin-On

GEHL 184223
J.C.BAMFORD 32/925423
MASSEY-FERGUSON 4224811M1



H 1 : 134 (mm)
OD 1 : 93 (mm)
Thread Size : M24X2-6H
Gasket Type : Square

CONT : 25
VOL : 0.049

Note : Conversion Adapter on first installation not included

323

SFC-55170 Fuel/Water Separator Spin-On High Efficiency

CATERPILLAR 1R-0770



H 1 : 195 (mm)
OD 1 : 108 (mm)
Thread Size : 1-14 UNS-2B

CONT : 12
VOL : 0.038

Note : bowl not included, media 12 micron

328

O-7902 Oil Filter Full Flow Metal End Cap Element

CUMMINS 5577223



H 1 : 191 (mm)
H 2 : 181 (mm)
OD 1 : 150 (mm)
OD 2 : 150 (mm)
ID 1 : 42 (mm)
ID 2 : 42 (mm)

CONT : 25
VOL : 0.149

Note : Metal Protector

319

SFC-5504-10 Fuel/Water Separator Secondary Spin-On 10 Micron

CATERPILLAR 133-5673



H 1 : 217 (mm)
OD 1 : 108 (mm)
Thread Size : 1-14 UNS-2B
Gasket Type : Square

CONT : 10
VOL : 0.037

Note : bowl not included

324

SFC-55180 Fuel/Water Separator Spin-On

CATERPILLAR 1R-0769



H 1 : 191 (mm)
OD 1 : 108 (mm)
Thread Size : 1-14 UNS-2B
Gasket Type : Square

CONT : 12
VOL : 0.040

Note : bowl not included

329

SF-1907 Fuel/Water Separator Metal End Cap Element

CATERPILLAR 1110716
SEPAR 20210
CATERPILLAR 9Y4446



H 1 : 247.5 (mm)
H 2 : 245 (mm)
OD 1 : 109 (mm)
OD 2 : 109 (mm)
ID 1 : 16 (mm)
ID 2 : 21 (mm)

CONT : 16
VOL : 0.066

Note : Hanger

320

SFC-5504-10B Fuel/Water Separator Secondary Spin-On With Bowl 10 Micron

CATERPILLAR 133-5673
NISSAN 16403-NY00C



Primary Filter uses SFC-5504-30B

H 1 : 311 (mm)
H 2 : 217 (mm)
OD 1 : 108 (mm)
Thread Size : 1-14 UNS-2B
Gasket Type : Square

CONT : 10
VOL : 0.050

325

SFC-55240 Fuel/Water Separator Spin-On

PERKINS 2656F501
PERKINS 2656F853
CATERPILLAR 308-7298



H 1 : 170 (mm)
H 2 : 163 (mm)
OD 1 : 93.5 (mm)
Thread Size : M22X1.5-6H
Gasket Type : Square

CONT : 12
VOL : 0.026

Note : bowl not included

330

SFC-55250

Fuel/Water Separator Spin-On High Efficiency

CATERPILLAR 326-1643



H 1 : 226 (mm)
OD 1 : 108 (mm)
Thread Size : 1-14 UNS-2B
Gasket Type : Round

CONT : 12
VOL : 0.046

Note : bowl not included,media 10 micron

331

WC-6901

Coolant Filter Spin-On

CUMMINS 3305371
INGERSOLL RAND 56985971



H 1 : 189 (mm)
OD 1 : 93 (mm)
Thread Size : 11/16-16 UNF-2B
Gasket Type : Square

CONT : 12
VOL : 0.029

Note : Coolants = 23 units

336

SFC-55280

Fuel/Water Separator Spin-On High Efficiency

CATERPILLAR 438-5386



H 1 : 334 (mm)
H 2 : 305 (mm)
OD 1 : 136 (mm)
Thread Size : 1 1/4-12 UNF-2B

CONT : 6
VOL : 0.046

Note : SFC-55281 (Media difference)

332

SFC-55281

Fuel/Water Separator Spin-On High Efficiency

CATERPILLAR 438-5385



H 1 : 334 (mm)
H 2 : 305 (mm)
OD 1 : 136 (mm)
Thread Size : 1 1/4-12 UNF-2B

CONT : 6
VOL : 0.046

Note : SFC-55280 (Media difference)

333

WC-5705

Coolant Filter Spin-On

CUMMINS 299080
CUMMINS 3100304
CUMMINS 3305367



H 1 : 100 (mm)
OD 1 : 93 (mm)
Thread Size : 11/16-16 UNF-2B
Gasket Type : Square

CONT : 12
VOL : 0.018

Note : Coolants = 4 units

334

WC-5708

Coolant Filter Spin-On

GENERAL MOTORS 23507189
FIAT 4393504
CASE 441365C1



H 1 : 136 (mm)
OD 1 : 93 (mm)
Thread Size : 11/16-16 UNF-2B
Gasket Type : Square

CONT : 12
VOL : 0.021

Note : Coolant = 15 units

335